

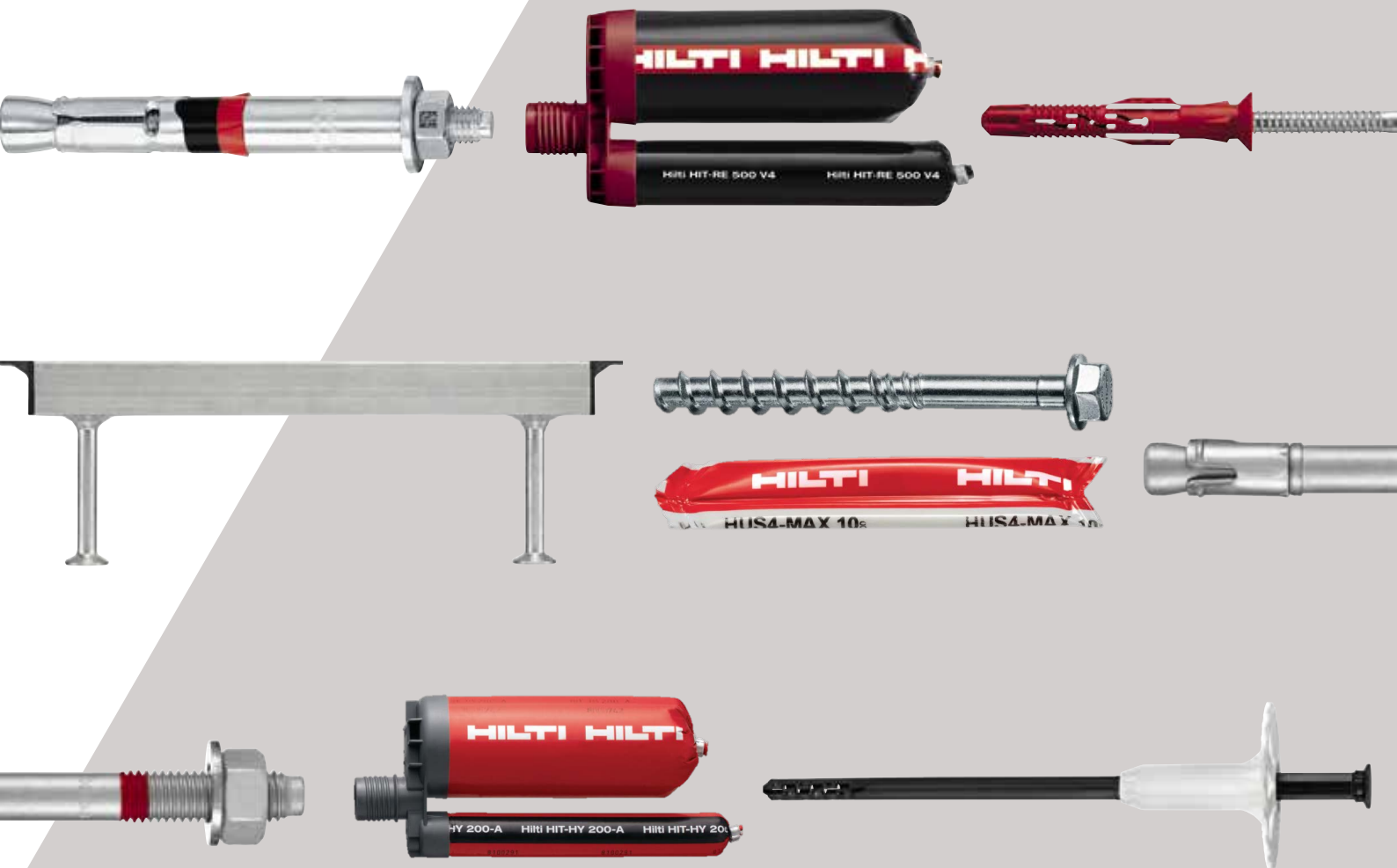

# ANCHOR FASTENING TECHNOLOGY MANUAL

Version 2023



## Important notices

1. The technical data presented in this Anchor Fastening Technology Manual is based on numerous tests and evaluation criteria according to the current state of the art and the relevant European regulations.
2. For all those anchors holding a European Technical Assessment (ETA), noted in the cover with the respective icon, the technical data given in this manual is based on and is in accordance with the information given in the respective ETA. Additional Hilti technical data, supplementing the ETA technical data, may be available; in which case, it will be clearly noted on footnotes and/or tables.
3. For all those anchors not holding an ETA, the technical data given in this manual is based on numerous tests and evaluation criteria according to the current state of the art and/or the relevant European applicable regulations for the assessment of fasteners, which is the basis for obtaining an ETA.
4. In addition to the tests for standard service conditions including, in some cases, seismic, fire resistance, shock and fatigue tests may have been performed - see respective reports for full details.
5. The data and values are based on tests under laboratory or other controlled conditions, or on generally accepted methodology. It is the responsibility of the customer to use the data given in the light of conditions on site and to consider the intended use of the products concerned. The customer must check that the listed prerequisites and criteria conform with the conditions existing on the jobsite. Whilst Hilti can give general guidance and advice, the nature of Hilti products means that the ultimate responsibility for selecting the right product for a particular application must lie with the customer.
6. The given technical data in the Anchor Fastening Technology Manual is valid only for the indicated service conditions. Due to variations in local base materials, on-site testing may be required to determine performance at any specific jobsite.
7. Technical data presented herein was current as of the date of publication (see back cover). Hilti's policy is one of continuous development. We therefore reserve the right to alter technical data and specifications, etc. without notice.
8. Construction materials and conditions vary on different sites. If it is assumed that the base material has insufficient strength to achieve a suitable fastening, contact the Technical Competence Center of your local Hilti organization.
9. All products must be used, handled and applied strictly in accordance with all current instructions for use published by Hilti, i.e., technical instructions, operating manuals, setting instructions, installation manuals and others.
10. All products are supplied, and advice is given, subject to the local Hilti organization terms of business.
11. While reasonable measures have been taken to provide accurate information, no warranty is provided that it is without error. Hilti shall in no event be obligated for direct, indirect, incidental, consequential, or any other damages, losses, or expenses in connection with, or by reason of, the use of, or inability to use, the products or information for any purpose. Implied warranties of merchantability and fitness for a particular purpose are specially excluded.

Hilti Corporation  
FL-9494 Schaan  
Principality of Liechtenstein  
[www.hilti.group](http://www.hilti.group)



## Table Of Content

### 1. INTRODUCTION

1.1	Legal environment	5
1.1.1	Technical data	5
1.1.2	European Technical Approval Guidelines	5
1.2	Design Principles and Applications	6
1.2.1	Base material	6
1.2.2	Anchor working principles	7
1.2.3	Design approach	10
1.2.4	The right design for the right application	11
1.2.5	What is the Hilti filling set and how to use it	12
1.3	Anchor selector: overview from the application to the anchor	14
1.4	Anchor selector: focus on the product	17

### 2. CHEMICAL ANCHORS

2.1	Concrete	
2.1.1	HIT-HY 200 R V3	28
2.1.2	HIT-HY 200 A/R	75
2.1.3	HIT-RE 500 V4	125
2.1.4	HIT-RE 500 V3	169
2.1.5	HIT-FP 700 R	208
2.1.6	HIT-RE 100	219
2.1.7	HIT-RE 100 hard cartridges	249
2.1.8	HIT-CT 1	278
2.1.9	HIT-RE 10	304
2.1.10	HIT-ICE	324
2.1.11	HVU-TZ	341
2.1.12	HUS4 MAX	352
2.1.13	HVU2	365
2.2	Multimaterial	
2.2.1	HIT-HY 170	382
2.2.2	HIT-MM Plus	424
2.2.3	HIT-1/ HIT-1 CE	447
2.3	Masonry	
2.3.1	HIT-HY 270	463

### 3. MECHANICAL ANCHORS

3.1	Expansion anchors	
3.1.1	HST3	496
3.1.2	HST2	509
3.1.3	HSA	520
3.1.4	HSV	531
3.1.5	HSB	536
3.1.6	HSL-4	541
3.1.7	HSL-3 (R)	559
3.2	Screw anchors	
3.2.1	HUS4	572
3.2.2	HUS4-HR/ HUS4-CR	596

3.2.3	HUS3 H	606
3.2.4	HUS-V	627
3.2.5	HUS2-H	635
3.2.6	HUS 6/ HUS-S 6	644
3.2.7	HUS3/ HUS-HR/ HUS-CR redundant	650
3.3	Undercut anchors	
3.3.1	HDA	664
3.3.2	HMU-PF	678
3.3.3	HSC-A (R)/ HSC-I (R)	686
3.4	Flush anchors	
3.4.1	HKD	698
3.4.2	HKD redundant	705
3.4.3	HKV	716
3.5	Plastic anchors	
3.5.1	HRD	721
3.5.2	HRD redundant	728
3.5.3	HRV	746
3.5.4	HPS-1	752
3.5.5	HUD-1	756
3.5.6	HUD-2	763
3.5.7	HUD-L	770
3.5.8	HLD	775
3.5.9	HMF	779
3.5.10	GD14+GRS	784
3.6	Light duty anchors	
3.6.1	HFB	788
3.6.2	DBZ	797
3.6.3	HK	803
3.6.4	HLC	813
3.6.5	HT	820
3.6.6	HLV	824
3.6.7	HAM	829
3.6.8	HPD	833
3.6.9	HKH	839
3.6.10	HCA	844
3.6.11	HHD-S	849
3.6.12	HSP/ HFP	852
3.6.13	HA8 NG	855
3.6.14	HTB 2	859
3.7	Anchor for insulation	
3.7.1	HIF	862
3.7.2	HTH	867
3.7.3	HTR-P (M)	880
3.7.4	HTS-P (M)	890
3.7.5	IDP	900
<b>4.</b>	<b>ANCHOR CHANNELS</b>	
4.1.1	HAC-C (cold formed/ hot rolled)	904
4.1.2	HAC-C-P (hot rolled)	936
4.1.3	HAC-V	953

# 1. INTRODUCTION

## 1.1 Legal environment

### 1.1.1 Technical data

The technical data presented in this Anchor Fastening Technology Manual are all based on numerous tests and evaluation according to the state of the art. Hilti anchors are tested in our test labs in Kaufering (Germany), Schaan (Principality of Liechtenstein), Zhanjiang (CN) or Irving (USA) and evaluated by our experienced engineers and/or tested and evaluated by independent and accredited testing institutes in Europe and the USA. Where national or international regulations do not cover all possible types of applications, additional Hilti data helps to find customized solutions.

In addition to the standard tests for admissible service conditions and suitability tests, tests are performed for safety relevant applications such as fire resistance, shock, seismic and fatigue.

### 1.1.2 European Technical Approval Guidelines

European standards and regulatory frameworks guide testing, assessment and design of post-installed systems. The construction products regulation (CPR) lays down harmonized rules for marketing construction products in Europe. Below are definitions to help facilitate understanding of the wording that may be used along the document:

#### **European Committee for Standardization (CEN)**

CEN, recognized by the European Union as a European Standardization Organization, brings together knowledge and expertise from its members, from business and industry and from other stakeholders, in order to develop European Standards. CEN provides a platform for the development of European Standards and other technical documents in relation to various kinds of products, materials, services and processes. They help to protect the environment, as well as the health and safety of consumers and workers.

#### **European Organization for Technical Assessment (EOTA)**

EOTA is set up by the Regulation (EU) No 305/2011 and comprises all Technical Assessment Bodies (TABs) designated by member states of the European Union and the European Economic Area.

EOTA co-ordinates the application of the procedures set for requests for European Technical Assessment (ETA) and for the procedures for adopting a European Assessment Document (EAD). EOTA also informs the European Commission and the Standing Committee on Construction of any question related to the preparation of EADs and suggests improvements to the European Commission based on its gained experience.

#### **European Assessment Document (EAD)**

A European Assessment Document, or EAD for short, is a harmonized technical specification developed by EOTA as the basis for European Technical Assessments (ETAs). The development of new, or the amendment of existing, EADs is usually triggered by an ETA request from a manufacturer.

#### **European Technical Assessment (ETA)**

The European Technical Assessment (ETA) provides an independent Europe-wide procedure for assessing the essential performance characteristics of a construction product. It provides the documented assessment of the performance of a construction product, in relation to its essential characteristic, in accordance with the respective EAD.

#### **Technical Reports (TR)**

EOTA Technical reports are developed as supporting documents to EADs containing detailed aspects relevant for construction products such as design, execution and evaluation of tests, and express the common understanding of existing knowledge and experience of the Technical Assessment Bodies in EOTA at a particular point in time.

### **Eurocodes**

Eurocodes, or EC or EN, are harmonized technical rules specifying how structural design should be conducted within the European Union. These codes have been developed by the European Committee for Standardization upon the request of the European Commission.

## **1.2 Design Principles and Applications**

### **1.2.1 Base material**

The wide variety of building materials used today provide different anchoring conditions. There is hardly a base material in or to which a fastening cannot be made with a Hilti product. However, the properties of the base material play a decisive role when selecting a suitable fastener / anchor and determining the load it can hold. The main building materials suitable for anchor fastenings are described in the following paragraphs.

#### **Concrete**

Concrete consists of a mixture of cement, aggregates, water and possibly also additives, which is produced when the cement paste hardens and cures. Concrete has a relatively high compressive strength, but only low tensile strength. Steel reinforcing bars are cast in concrete to take up tensile forces. It is then referred to as reinforced concrete.

If the tensile strength of concrete is exceeded cracks will form. Reinforcement detailing according to state-of-the-art design codes (e.g., Eurocode 2) ensure a limitation of these cracks to 0.3 mm at serviceability limit state. Individual cracks might be wider at ultimate limit state. If a concrete component is subjected to a bending load, the cracks have a wedge shape across the component cross-section, and they end close to the neutral axis. It is recommended that anchors suitable in cracked concrete used in the tension zone. Other types of anchors can be used if they are set in the compression zone.

In general, as reported in the EN 1992-4 (Design of fastenings for use in concrete), it is conservative to assume that the concrete is cracked over its service life. Uncracked concrete may be assumed if it is proven that under the characteristic combination of loading at the serviceability limit state, the fastener is expected to be located in uncracked concrete for its entire service life.

Anchors can be set in both low-strength and high-strength concrete. Generally, the range of the compressive strength is between C20/25 and C50/60.

Cutting through reinforcement when drilling anchor holes must be avoided. If this is not possible, a design engineer responsible must be consulted first.

#### **Masonry**

Masonry is a heterogeneous base material consisting of brick of various materials and mortar joints with different mechanical properties. The hole being drilled for an anchor can run into mortar joints or cavities. Owing to the relatively low strength of masonry, the loads taken up locally cannot be particularly high. A tremendous variety of types and shapes of masonry bricks on the market, e.g., clay bricks, sand-lime bricks or concrete bricks, all of different shapes and either solid or with cavities. Hilti offers a range of different fastening solutions for this variety of masonry base material, e.g., the HIT HY 270, HRD, HUD,

HPS-1 etc. If there are doubts when selecting a fastener, your local Hilti sales representative or field engineer will be pleased to provide assistance.

When designing a fastening, care must be taken to ensure that a layer of insulation or plaster is not used as the base material. The specified anchorage depth (depth of embedment) must be in the actual base material.

### Other base materials

Aerated concrete: This is manufactured from fine-grained sand as the aggregate, lime and/or cement as the binding agent, water and aluminum as the gas-forming agent. The density range from about 400 and 800 kg/m<sup>3</sup> and the compressive strength from 2 to 8 N/mm<sup>2</sup>. Hilti offers the HUS, HPS-1 and HRD-U anchors for this base material.

Lightweight concrete: This is concrete which has a low density, i.e.,  $\rho < 2000 \text{ kg/m}^3$ , and a porosity that reduces the strength of the concrete and thus the loading capacity of an anchor. Hilti offers the HRD, HUD, HMF etc. anchor systems for this base material.

Drywall (plasterboard/gypsum) panels: These are mostly building components without a structural function, such as wall and ceiling panels, to which less important, so-called secondary fastenings are made. The Hilti anchors suitable for this material are the HTB 2, HMF, HUD and HHD-S product lines.

In addition to the previously named building materials, it is possible to encounter some other types, e.g., natural stone or special building components, e.g., hollow ceiling components.

Descriptions and explanations of each of these would go beyond the bounds of this manual.

Generally, though, fastenings can be made to these materials. In some cases, test reports exist for these special materials. It is also recommended that the design engineer, company carrying out the work contact the Hilti technical staff in each case.

In some specific cases, testing on the jobsite should be arranged to verify the suitability and the loading capacity of the selected anchor. To perform on-site testing you can directly connect with your local Hilti counterpart.

## 1.2.2 Anchor working principles

### Working principles in steel to concrete connections

In anchoring a steel element to the concrete, it is possible to observe four main working principles illustrated in the following:

#### Friction

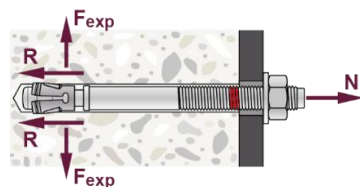

The tensile load,  $N$ , is transferred to the base material by friction,  $R$ . This is the load-transfer mechanism typical of expansion anchors, where a clip or a wedge is pressed against the walls of the bore-hole during the installation process. In the case of torque-controlled expansion fasteners a hole is drilled, and the fastener is inserted into the drill hole and anchored by tightening the screw or nut with a calibrated torque wrench. A tensile force is produced in the bolt, the cone at the tip of the anchor is drawn into the expansion sleeve and forced against the sides of the drilled hole. Within the torque-controlled expansion fasteners are distinguished sleeve types (e.g., HSL4) and bolt types where the anchor is expanded through an expansion clip instead of a sleeve (e.g.; HST3 as per the drawing on the left). Deformation-controlled anchors comprise an expansion

sleeve and cone. They are set in place by expanding the sleeve through controlled deformation. This is achieved either by driving the cone into the sleeve or the sleeve over the cone (e.g., HKD).

### Mechanical interlock

With the mechanical interlock working principle the load is transferred by means of a bearing interlock between the fastener and the base material. Typical examples includes undercut fasteners, concrete screws and anchor channels.

Undercut anchors develop a mechanical interlock between the anchor and the base material. To do this, a cylindrically drilled hole is modified to create a notch, or undercut, of a specific dimension at a defined location either by means of a special drilling apparatus, or by the undercutting action of the anchor itself. In cases of self-undercutting the undercut is generated using the expansion element inserted into the pre-drilled hole. Use of rotary-impact action permits the expansion element to simultaneously undercut the concrete and widen to its fully installed position. This process results in a precise match between the undercut form and the anchor geometry (e.g., HAD as per drawing on the left).

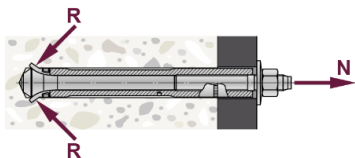

Concrete screws which work by using mechanical interlock principle distributed along the entire anchor length, are gaining popularity thanks to their high performance and installation productivity. Screw anchors are typically hardened to permit the thread to engage the base material during installation. They are installed in drilled holes. They may be driven by means of special impact drivers, or in other systems using a conventional drill equipped with an adapter. The diameter of the drilled hole is matched to the geometry of the screw so that the thread cuts into the concrete and an external force can be transferred to the concrete through this positive interlocking connection (e.g., HUS4 as per drawing on the left).

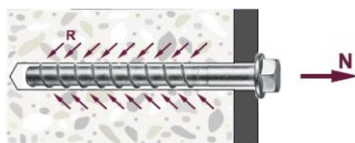

Anchor channels are anchored in concrete by mechanical interlock between the anchor and the concrete member. Differently from previous anchor types, anchor channels are so called cast-in place systems installed before concrete pouring (e.g., HAC-C).

### Bonding

The forces are transferred from the anchor element (e.g., threaded rod) to the mortar via mechanical interlocking and to the anchor base via a combination of micro-interlock, and chemical adhesion between the mortar and hole wall. Bonded anchors are available in various systems. A distinction can be made between anchors in which the mortar is contained in plastic or glass capsules (e.g., HVU2) and injection systems in which the mortar is delivered from cartridges or foil packs in the bore hole by a dispenser (e.g., RE500v4 and HY200-R V3).

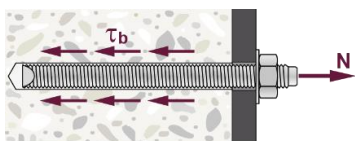

### Combined working principles

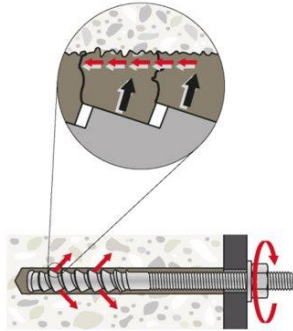

Some anchor systems work combining some of the basic principles described previously. Some examples are:

**Hybrid screws:** they rely on combination mechanical interlocking and bonding. A screw fastener, which cuts a thread into the concrete, and bonding material. Both components contribute to the functioning of the fastening system (e.g., HUS4 MAX)

**Bonded expansion fasteners** transfer loads into the base material combining bond and friction: those fasteners are installed in cylindrical hole, the load transfer is obtained by mechanical interlock of a cone or several cones in the bonding material and then via combination of bonding and friction forces in the concrete (e.g., HIT-Z rod with HIT-HY 200 A/R mortar as per drawing on the left).

The weakest resistance to the possible failure modes of an anchor fastening determines the cause of failure. Typical failures under tension loads are steel failure, concrete cone, pullout or combined concrete cone-pullout and splitting. Failure modes under shear loads are steel failure, pryout and concrete edge breakout.

The following illustration visually shows the mentioned failure modes:

### Failure modes under tension loads for post-installed anchors

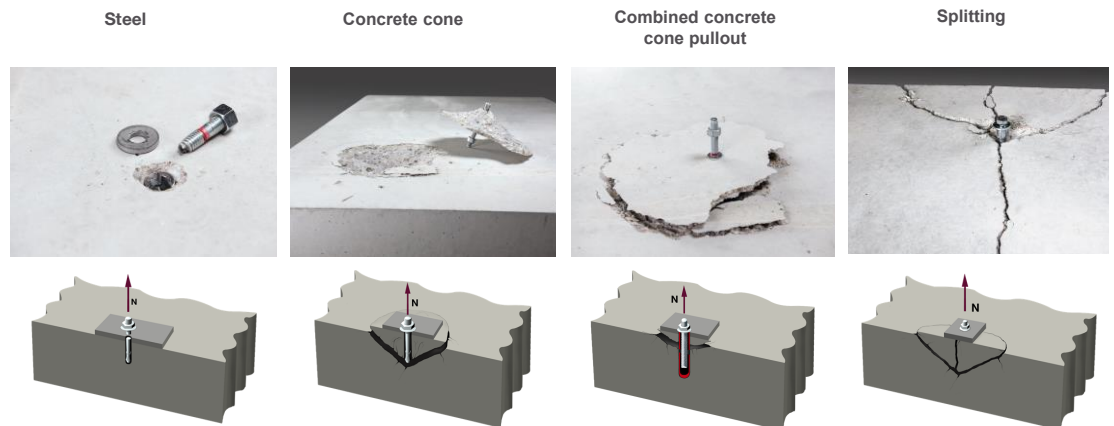

### Failure modes under shear loads for post-installed anchors

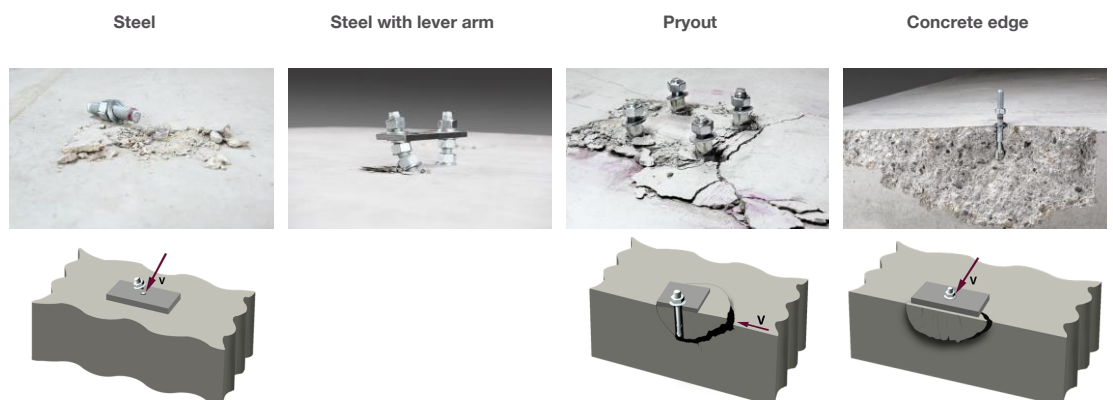

### Working principles in concrete-to-concrete connections

In the connection of two different concrete elements the basic load transfer of an acting tension force into the concrete is similar to the one of cast-in rebar. Both cast-in and post-installed rebar generate a rotationally symmetric stress pattern around the bar. Equilibrium is provided by the hoop stresses (tangential) in the concrete. Same failure modes of cast-in and post-installed rebar can be observed. The rebars can fail by steel rupture, pullout/bond failure and splitting failure. The only difference is that for cast-in reinforcing bars, the tension loads are directly transferred from the rebar to the base material. For post-installed reinforcing bars, they are transferred by mechanical interlock from the reinforcing bar's ribs to the mortar and via bond (i.e., combination of adhesion and micro keying) from the mortar into the concrete member.

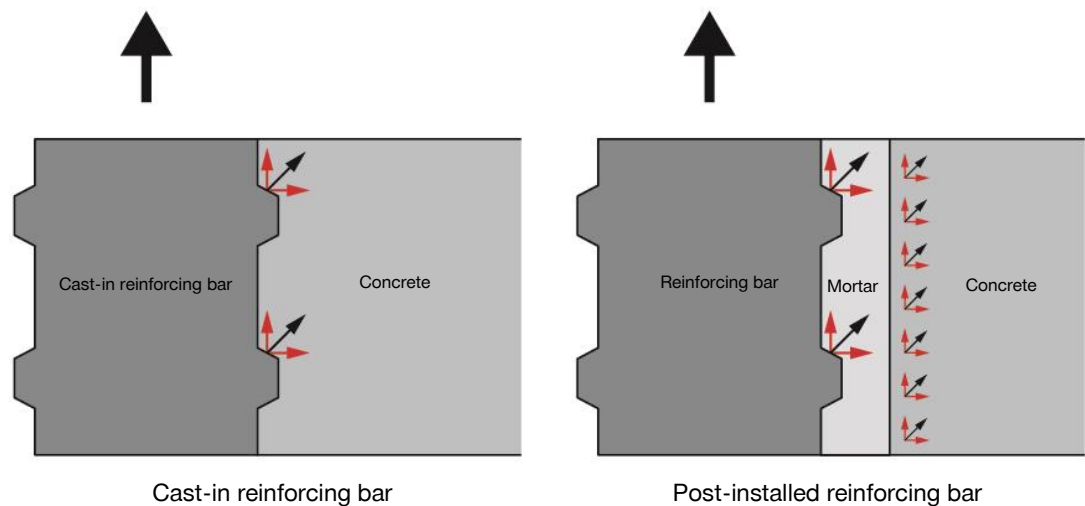

### 1.2.3 Design approach

For anchors for use in concrete having an European Technical Assessment (ETA) the partial safety factor concept according to the Eurocodes shall be applied. It has to be shown, that the value of design actions does not exceed the value of the design resistance:  $S_d \leq R_d$ .

For the characteristic resistance given in the respective ETA, reduction factors due to e.g., freeze/thaw, service temperature, durability, creep behavior and other environmental or application conditions are already considered.

According to the Eurocodes the partial safety factor is  $\gamma_G = 1.35$  for permanent and  $\gamma_Q = 1.5$  for variable static or quasi-static actions are usually applicable.

#### Partial safety factor concept

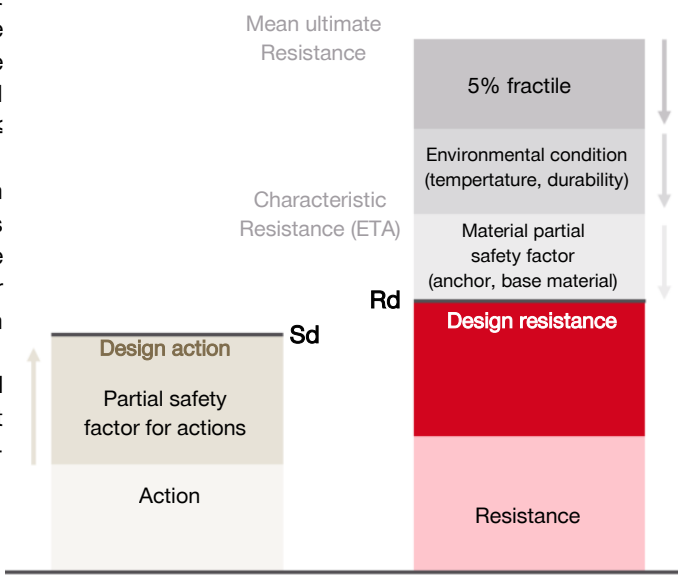



**1.2.4 The right design for the right application**

		I need to fix							
		A steel baseplate				A new concrete member			
		To concrete		To masonry		To concrete		To concrete	
						Transmitting loads through the overlapping with existing rebar or, if there is no overlapping, transmitting only pure shear 		Transmitting shear loads plus tension and/or bending moment without overlapping in the existing concrete member 	
Design Load		Static	Seismic	Fire	Fatigue	Static	Seismic	Fire	Fatigue
	Working Life	50/ 100 years		50 years		50/ 100 years		Not available	
		EC2-4		EC2-4 TR061		TR054		Not available	
Design Method		EC2-1-1		EC8-1		EC2-1-2		Not available	
		EC2-1-1 TR069		TR069		Not available		Not available	
		Not available		Not available		Not available		Not available	

Do you want to design the full application?  
Click [this link](#) to get free access to the software PROFIS Engineering software

### 1.2.5 What is the Hilti filling set and how to use it

If an anchor group is loaded towards the edge of a concrete member (shear load), the gap between anchor shaft and clearance hole can have a significant effect on the load-bearing behavior of the anchor group. An uneven shear load distribution within the anchors of the group is the result as the clearance hole is always larger than the anchor diameter to ensure an easy installation. EN1992-4 takes this fact into account by assuring that only the row of anchors nearest to the concrete edge takes up all shear load.

To guarantee an even load distribution in case of shear loading, filling of the annular gap is necessary. This will allow all anchors to take up the shear loads.

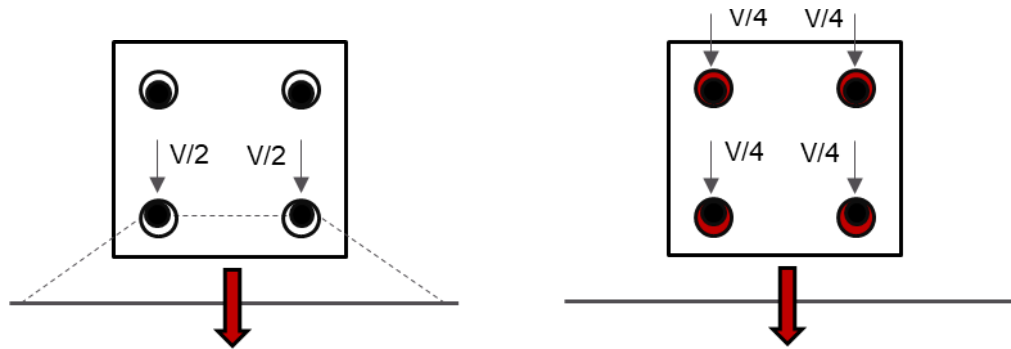

In case of hole clearance, you never know where the anchor is located relative to the hole in the steel plate. Therefore, always the worst configuration is assumed

In case the annular gap is filled, all anchors are assumed to take up shear loads

If an unsuitable filling method is used, it cannot be guaranteed that the annular gap is properly filled with mortar. Therefore, the method needs to be qualified. Hilti always recommends using the Hilti filling set. This consists of a special sealing washer, which permits HIT injection adhesive to be dispensed into the clearance hole and a spherical washer, a nut and a lock nut to prevent loosening of the nut.

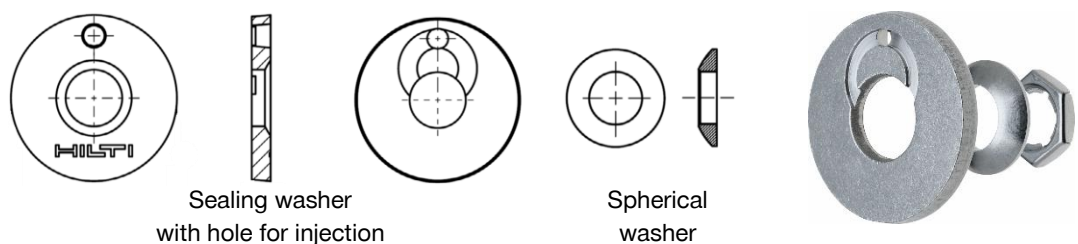

Sealing washer  
with hole for injection

Spherical  
washer

Not using the Hilti filling set can lead to an improper filling of the annular gap.



Hilti filling set used

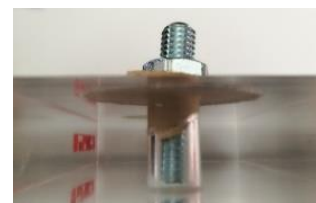

Unsuitable filling method used

In case of chemical anchors, the borehole is sealed. No mortar can enter the borehole and the functionality of the anchor is not influenced independent of the mortar used to fill the annular gap.

In case of mechanical anchors, mortar entering the borehole can negatively influence the load-bearing behavior (e.g., disturbance of follow up expansion needed to activate the anchor in cracked concrete). Therefore, close attention needs to be paid to the mortars covered in the installation instruction (IFU). The IFU requires to use for all expansion and undercut anchors Hilti HIT-HY products as per the table below:

Anchor	HIT-HY... HIT-RE...	HST, HST2, HST3, HDA, HSL4, HMU, HSA	HUS3 HUS4	HUS4 Max
Element	HAS-(U/D/TZ), HIT-V/Z/C, AM, HZA, HIS-N	-	-	HUS4
<b>HIT-HY* products</b> Filling set suitability	Yes	Yes	Yes	Yes
<b>HIT-RE** products</b> Filling set suitability	Yes	No	Yes	Yes

\*HIT-HY: 200-A, 200-R, 200 R-V3, 270, 170, 100, CT1

\*\*HIT-RE: 500 V4, 500 V3, 100, 100-HC, 10

#### When is the use of the filling set needed?

Load type		
Static loading	Fatigue loading	Seismic loading
<p><b><u>Filling set is not needed:</u></b></p> <p>1) Pure tension loading</p> <p>2) The minimum edge distance in all directions is larger than <math>\max(10h_{ef}, 60d_{nom})</math></p> <p>3) Concrete edge breakout in shear is verified according EN 1992-4</p> <p><b><u>Filling set is needed:</u></b></p> <p>Concrete edge breakout is verified according to the SOFA method. This method requires that all anchors are evenly loaded in shear.</p>	<p><b><u>Filling set is always required in case the design is done acc. to EN 1992-4:</u></b></p> <p>EN 1992-4, section 8.1 (6): Annular gaps are not allowed and loosening of the nut or screw shall be avoided (both for tension and shear loading).</p> <p><b><u>Filling set is required for shear loading in case the design is done according to EOTA/TR 061:</u></b></p> <p>EOTA/TR 061, section 1.1: If only tension loads are involved in the application, the annular gap does not need to be filled.</p>	<p><b><u>The use of a filling set is optional, however brings two benefits in design:</u></b></p> <p>1) To consider a so-called hammering effect on the anchors in case of hole clearance, EN 1992-4 requires to reduce the group capacity in case of shear loading by a factor <math>\alpha_{gap}</math>.  <math>\alpha_{gap} = 0.5</math> in case the annular gap between anchor and steel plate is not filled, a 50% reduction is applied.  <math>\alpha_{gap} = 1.0</math> in case the annular gap between anchor and steel plate is filled (no reduction).</p> <p>2) For some products a higher value <math>V_{Rk,s,seis}</math> (seismic steel resistance in shear) is given in the ETA (e.g. HST3)</p>

### 1.3 Anchor selector: overview from the application to the anchor

Anchor type			Chemical anchor				
			Applications				
			Post-Installed Rebar	Baseplate To Concrete	Baseplate To Masonry	HVAC	Façade
Concrete	Hilti HIT-HY 200 R V3		■	■			■
	Hilti HIT-HY 200 A/R		■	■			■
	Hilti HIT-RE 500 V4		■	■			■
	Hilti HIT-RE 500 V3		■	■			■
	Hilti HIT-FP 700 R		■				
	Hilti HIT-RE 100		■	■			
	Hilti HIT-RE 100-HC		■	■			
	Hilti HIT-CT 1		■	■			
	Hilti HIT-RE 10		■	■			
	Hilti HIT-ICE			■			
	HVU2			■		■	■
	HVZ			■			
	HUS4-MAX			■			■
	Multimaterial	Hilti HIT-HY 170		■	■	■	■
Hilti HIT-MM Plus				■	■	■	
Hilti HIT-1				■	■	■	
Masonry	Hilti HIT-HY 270				■		■

Anchor type			Mechanical anchor				
			Applications				
			Post-Installed Rebar	Baseplate To Concrete	Baseplate To Masonry	HVAC	Façade
Undercut	Concrete	HDA			■		
		HMU-PF			■		■
		HSC			■		■
Expansion anchors	Concrete	HSL-4			■		
		HSL-3 (R)			■		
		HST3			■		■
		HST2			■		■
		HSA			■		■
		HSV			■		■
		HSB			■		■
		HKD			■		■
		HKD redundant			■		■
		HKV			■		■
Flush anchors	Concrete	HUS4			■	■	■
		HUS4-HR/CR					■
		HUS3			■	■	■
		HUS 6 HUS-S 6			■	■	
		HUS/ HUS3 redundant					■
Screw anchors	Multimaterial	HPS-1			■	■	■
		HUD-1			■	■	■
		HUD-2			■	■	■
		HUD-L			■	■	
		HMF					■
		GD14+GRS					
		HRV			■	■	■
		HRD			■	■	■
		HRD Concrete			■	■	■
		HLD Drywall					■

Anchor type				Mechanical anchor				
				Applications				
				Post-Installed Rebar	Baseplate To Concrete	Baseplate To Masonry	HVAC	Façade
Light duty metal anchors	Drywall	HHD-S					■	
		HSP/HFP					■	
	Multimaterial	HLC			■	■		
		HAM			■	■		
		HTB 2					■	
		HT						
		HPD AAC			■			
	Concrete	HKH Hollow concrete			■			
		HLV			■			
		HK						
		HFB			■			
		DBZ			■		■	
		HCA			■			
HA8 NG								
Channels	HAC-C					■	■	
	HAC-C-P					■	■	
	HAC-V					■	■	

Anchor type			Base material suitability				
			Concrete	Solid Clay Masonry	Hollow Clay Brick	Lightweight Aggregate Concrete	AAC
Anchor for insulation	HIF		■	■	■		■
	HTH		■	■	■		■
	HTR-P(M)		■	■	■	■	■
	HTS-P(M)		■	■	■	■	■
	IDP		■	■	■		

## 1.4 Anchor selector: focus on the product

Anchor type		HIT-HY 200 R V3				HIT-HY 200 A/R				HIT-RE 500 V4			HIT-RE 500 V3		
Anchor size		M8/ M20	M8/ M30	M8/ M20	φ8/ φ40	M8/ M20	M8/ M30	M8/ M20	φ8/ φ32	M8/ M39	M8/ M20	φ8/ φ40	M8/ M39	M8/ M20	φ8/ φ40
Base material	Cracked concrete	■	■	■	■	■	■	■	■	■	■	■	■	■	■
	Non-cracked concrete	■	■	■	■	■	■	■	■	■	■	■	■	■	■
	Lightweight concrete														
	Aerated concrete														
	Solid brick masonry														
	Hollow brick masonry														
	Drywall														
European technical data (ETA)		■	■	■	■	■	■	■	■	■	■	■	■	■	■
ETA for 100 years design life		■	■	■	■	■	■	■	■	■	■	■	■	■	■
Load types	Static/ Quasi-static	■	■	■	■	■	■	■	■	■	■	■	■	■	■
	Seismic C1 (Baseplate to concrete)	■	■		■	■	■		■	■	■	■	■	■	■
	Seismic C2 (Baseplate to concrete)	■	■			■	■			■			■		
	Seismic (Concrete to concrete)				■				■			■			■
	Fatigue	with special rods: HAS-D or HIT-Z-D				with special rods: HAS-D or HIT-Z-D				■*			■*		
	Fire tested	■	■	■	■	■	■	■	■	■	■	■	■	■	■
Shock resistance*							■			■	■	■	■	■	■
Materials	Steel galvanized	■	■	■		■	■	■		■			■		
	Hot dip galvanized		■				■								
	Stainless steel A2														
	Stainless steel A4	■	■	■		■	■	■		■	■		■	■	
	HCR steel		■				■			■			■		
	Rebar class B and C				■				■			■			■
Setting	External thread	■	■			■	■			■			■		
	Internal thread	■	■	■		■	■	■		■	■		■	■	
	Pre-setting	■	■	■		■	■	■		■	■		■	■	
	Through-fastening	■	■	■		■	■	■		■	■		■	■	
	Diamond coring	■	■ <sup>a)</sup>	■ <sup>a)</sup>	■ <sup>a)</sup>	■	■ <sup>a)</sup>	■ <sup>a)</sup>	■ <sup>a)</sup>	■	■	■	■	■	■
	Hollow bit drilling	■	■	■	■	■	■	■	■	■	■	■	■	■	■
PROFIS Engineering		■	■	■	■	■	■	■	■	■	■	■	■	■	■

\*Local approvals

a) only with roughening tool

Anchor type		HIT-FP 700 R	HIT-RE 100 /HC	HIT-HY-CT 1	HIT-RE 10	HIT-ICE
Anchor size		φ8/ φ40	M8/ M30    φ8/ φ40	M8/ M24    φ8/ φ25	M8/ M30    φ8/ φ20	M8/ M24    M8/ M20    φ8/ φ25
Base material	Cracked concrete	■	■    ■	■    ■		■    ■    ■
	Non-cracked concrete	■	■    ■	■    ■	■    ■	■    ■    ■
	Lightweight concrete					
	Aerated concrete					
	Solid brick masonry					
	Hollow brick masonry					
	Drywall					
European technical data (ETA)		■	■    ■	■    ■		■    ■    ■
ETA for 100 years design life		■				
Load types	Static/ Quasi-static	■	■    ■	■    ■	■    ■	■    ■    ■
	Seismic C1 (Baseplate to concrete)					
	Seismic C2 (Baseplate to concrete)					
	Seismic (Concrete to concrete)	■				
	Fatigue					
	Fire tested	■				
	Shock resistance					
Materials	Steel galvanized		■	■	■	■    ■
	Hot dip galvanized			■		■
	Stainless steel A2					
	Stainless steel A4		■	■		■    ■
	HCR steel		■	■		■
	Rebar class B and C	■		■		■
Setting	External thread		■	■	■	■    ■
	Internal thread		■	■	■	■    ■
	Pre-setting		■	■	■	■    ■
	Through-fastening		■	■	■	■    ■
	Diamond coring	■				
	Hollow bit drilling	■	■    ■	■    ■		■    ■    ■
PROFIS Engineering		■		■    ■		■    ■    ■

\*Local approvals









Anchor type		HVU2		HVU-TZ	HUS4-MAX
Anchor size		M8/ M30	M8/ M20	M10/ M20	Diameter. 10/ 16
Base material	Cracked concrete	■	■	■	■
	Non-cracked concrete	■	■	■	■
	Lightweight concrete				
	Aerated concrete				
	Solid brick masonry				
	Hollow brick masonry				
	Drywall				
European technical data (ETA)		■	■	■	■
Load types	Static/ Quasi-static	■	■	■	■
	Seismic C1	■			■
	Seismic C2	■			■
	Fatigue			■	
	Fire tested	■	■	■	■
	Shock resistance*			■	
Materials	Steel galvanized	■	■	■	■
	Hot dip galvanized	■			■
	Stainless steel A2				
	Stainless steel A4	■	■	■	■
	HCR steel	■		■	
Setting	External thread	■		■	■
	Internal thread	■	■		■
	Pre-setting	■	■	■	
	Through-fastening	■	■	■	■
	Diamond coring	■	■	■	■
	Hollow bit drilling	■	■	■	
PROFIS Engineering		■	■	■	■







\*Local approvals

Anchor type		HIT-HY 170				HIM-MM Plus			HIT-1	HIT-HY 270		
Anchor size		M8/ M24	M8/ M16	M8/ M12	φ8/ φ32	M8/ M24	M8/ M12	M6/ M12	M8/ M16	M8/ M24	M8/ M12	M6/ M12
Base material	Cracked concrete	■			■							
	Non-cracked concrete	■	■		■	■	■		■			
	Lightweight concrete											
	Aerated concrete											
	Solid brick masonry	■		■		■	■	■	■	■	■	■
	Hollow brick masonry	■		■		■	■	■	■	■	■	
	Drywall											
European technical data (ETA)		■	■	■	■				■	■	■	■
Load types	Static/ Quasi-static	■	■	■	■	■	■	■	■	■	■	
	Seismic C1 (concrete)											
	Seismic C2 (concrete)	■										
	Seismic (masonry)									■		■
	Fatigue											
	Fire tested											
	Shock resistance											
Materials	Steel galvanized	■	■	■		■	■	■	■	■	■	
	Hot dip galvanized								■	■		
	Stainless steel A2											
	Stainless steel A4	■				■			■	■		
	HCR steel	■								■		
	Rebar class B and C				■							
Setting	External thread	■				■	■			■		
	Internal thread	■	■	■		■	■			■	■	
	Pre-setting	■	■	■		■	■	■	■	■	■	
	Through-fastening	■	■	■		■	■	■	■	■	■	
	Diamond coring											
	Hollow bit drilling	■			■							
PROFIS Engineering										■	■	■





\*Local approvals

Anchor type		HDA	HMU-PF	HSC	HSL-4	HSL-3 (R)	HST3	HST2
								
Anchor size		M10/ M20	M8/ M20	M6/ M12	M8/ M24	M8/ M20	M8/ M24	M8/ M16
Base material	Cracked concrete	■	■	■	■	■	■	■
	Non-cracked concrete	■	■	■	■	■	■	■
	Lightweight concrete							
	Aerated concrete							
	Solid brick masonry							
	Hollow brick masonry							
	Drywall							
European technical data (ETA)		■	■	■	■	■	■	■
Load types	Static/ Quasi-static	■	■	■	■	■	■	■
	Seismic C1	■	■		■	■	■	■
	Seismic C2	■	■	■	■		■	■
	Fatigue	■			■	■		
	Fire tested	■	■	■	■	■	■	■
	Shock resistance*	■		■	■	■		
Materials	Steel galvanized	■	■	■	■		■	■
	Hot dip galvanized	■	■					
	Stainless steel A2							
	Stainless steel A4	■		■		■	■	■
	HCR steel							
Setting	Redundant configuration							
	External thread	■	■	■	■	■	■	■
	Internal thread			■				
	Pre-setting	■	■	■	■	■	■	■
	Through-fastening				■	■	■	■
	Diamond coring				■		■	■
	Hollow bit drilling				■	■	■	■
	Adaptive torque.				■		■	■
QR code technology	■			■				
PROFIS Engineering		■	■	■	■	■	■	■

\*Local approvals

Anchor type		HSA	HSV	HSB	HKD	HKD redundant	HKV
							
Anchor size		M6/ M20	M8/ M16	M8/ M16	M6/ M20	M6/ M16	M6/ M16
Base material	Cracked concrete					■	
	Non-cracked concrete	■	■	■	■	■	■
	Lightweight concrete						
	Aerated concrete						
	Solid brick masonry						
	Hollow brick masonry						
	Pre-stressed hollow slab						■
European technical data (ETA)		■		■	■	■	
Load types	Static/ Quasi-static	■	■	■	■	■	■
	Seismic C1						
	Seismic C2						
	Fatigue						
	Fire tested	■				■	
	Shock resistance						
Materials	Steel galvanized	■	■	■	■	■	■
	Hot dip galvanized	■	■				
	Stainless steel A2	■					
	Stainless steel A4	■			■	■	
	HCR steel						
Setting	Redundant configuration					■	
	External thread	■					
	Internal thread		■	■	■	■	■
	Pre-setting	■	■	■	■	■	■
	Through-fastening	■					
	Diamond coring	■					
	Hollow bit drilling	■					
PROFIS Engineering		■			■		







\*Local approvals

Anchor type		HUS4	HUS4-HR/CR	HUS3	HUS 6 HUS-S 6	HUS/ HUS3 redundant
						
Anchor size		8/ 16	6/ 14	6/ 14	6	6/ 10
Base material	Cracked concrete	■	■	■	■	■
	Non-cracked concrete	■	■	■	■	■
	Lightweight concrete					
	Aerated concrete	■	■	■	■	
	Solid brick masonry	■	■	■	■	
	Hollow brick masonry				■	
	Pre-stressed hollow slab	■				■
European technical data (ETA)		■	■	■		■
Load types	Static/ Quasi-static	■	■	■	■	■
	Seismic C1	■	■	■		
	Seismic C2	■				
	Fatigue					
	Fire tested	■	■	■	■	■
	Shock resistance					
Materials	Steel galvanized	■		■	■	■
	Hot dip galvanized	■		■		
	Stainless steel A2					
	Stainless steel A4		■			
	HCR steel					
Setting	Redundant configuration				■	■
	External thread	■	■	■		■
	Internal thread	■	■	■	■	■
	Pre-setting					
	Through-fastening	■	■	■	■	■
	Diamond coring					
	Hollow bit drilling	■	■	■		
	Certified for reusability*	■		■		
PROFIS Engineering		■	■	■		







\*Local approvals

Anchor type		HPS-1	HUD-1	HUD-2	HUD-L	HMF	GD14+ GRS	HRV	HRD	HRD redundant	HLD
Anchor size		M4/ M8	M5/ M14	M5/ M8	M6/ M8	M5/ M14	M14	M10	M10	M8/ M10	M10
Base material	Cracked concrete								■	■	
	Non-cracked concrete	■	■	■	■	■	■	■	■	■	■
	Lightweight concrete	■	■	■	■	■		■			
	Aerated concrete	■	■	■	■	■		■		■	
	Solid brick masonry	■	■	■	■	■	■	■		■	■
	Hollow brick masonry	■	■	■	■	■		■		■	■
	Drywall		■	■	■	■				■	■
Pre-stressed hollow slab									■		
European technical data (ETA)										■	
Load types	Static/ Quasi-static	■	■	■	■	■	■	■	■	■	
	Seismic C1										
	Seismic C2										
	Fatigue										
	Fire tested										■
	Shock resistance										
Materials	Steel galvanized	■	■	■	■	■	■	■	■	■	■
	Hot dip galvanized							■	■	■	
	Stainless steel A2	■							■	■	
	Stainless steel A4									■	
	HCR steel										
Setting	Redundant configuration									■	
	External thread										
	Internal thread										
	Pre-setting		■	■	■						■
	Through-fastening	■	■	■	■	■		■	■	■	
	Diamond coring										
	Hollow bit drilling										
PROFIS Engineering											

\*Local approvals

Anchor type		HHD-S	HSP/ HFP	HLC	HAM	HTB 2	HT	HPD
								
Anchor size		M4/ M8		M5/ M16	M6/ M12	M5/ M6	M8/ M10	M5/ M10
Base material	Cracked concrete							
	Non-cracked concrete			■	■		■	
	Lightweight concrete						■	
	Aerated concrete						■	■
	Solid brick masonry			■	■	■	■	
	Hollow brick masonry					■	■	
	Drywall	■	■			■		
European technical data (ETA)								
Load types	Static/ Quasi-static	■	■	■	■	■	■	■
	Seismic C1							
	Seismic C2							
	Fatigue							
	Fire tested			■			■	■
	Shock resistance							
Materials	Steel galvanized			■	■		■	■
	Hot dip galvanized							
	Stainless steel A2							
	Stainless steel A4							■
	HCR steel							
Setting	Redundant configuration							
	External thread			■				■
	Internal thread	■			■			
	Pre-setting	■	■	■	■	■		■
	Through-fastening			■			■	
	Diamond coring							
	Hollow bit drilling							
PROFIS Engineering								

\*Local approvals

Anchor type		HKH	HLV	HK	HFB	DBZ	HCA	HA8 NG
								
Anchor size		M10/ M10	M5/ M12	M6/ M8	M6	M6	5/8'' (15,9 mm)	5,4 mm
Base material	Cracked concrete				■	■	■	
	Non-cracked concrete		■	■	■	■	■	■
	Lightweight concrete							
	Aerated concrete							
	Solid brick masonry							
	Hollow brick masonry							
	Drywall							
	Pre-stressed hollow slab	■						
European technical data (ETA)**				■	■	■		
Load types	Static/ Quasi-static	■	■	■	■	■	■	■
	Seismic C1				■			
	Seismic C2							
	Fatigue				■			
	Fire tested			■	■	■		
	Shock resistance							
Materials	Steel galvanized	■	■	■	■	■	■	■
	Hot dip galvanized							
	Stainless steel A2							
	Stainless steel A4	■		■	■			
	HCR steel			■	■			
Setting	Redundant configuration			■		■		
	External thread	■	■	■				
	Internal thread			■				
	Pre-setting	■	■	■				
	Through-fastening	■	■		■	■		
	Diamond coring							
	Hollow bit drilling							
	SI-AT compatibility							
	Certified for reusability*						■	
PROFIS Engineering								

\*Local approvals

\*\*Only for redundant fastening



Anchor type		HAC-C cold formed	HAC-C hot rolled	HAC-C-P	HAC	HAC-V
Channel size		HAC-C 28/15 HAC-C 38/17 HAC-C 40/25 HAC-C 49/30 HAC-C 54/33	HAC-C 40/22 HAC-C 50/30 HAC-C 52/34	HAC-C-P 40/22 HAC-C-P 40L HAC-C-P 50/30 HAC-C-P 50L	HAC-30, HAC-40, HAC-50, HAC-T50, HAC-60, HAC-70, HAC-T70	HAC-V-T30, HAC-V-35, HAC-V-40, HAC-V-50, HAC-V-50, HAC-V-60, HAC-V-70, HAC-V-T70
Base material	Cracked concrete	■	■	■	■	■
	Non-cracked concrete	■	■	■	■	■
	Lightweight concrete					
	Aerated concrete					
	Solid brick masonry					
	Hollow brick masonry					
	Drywall					
European technical data (ETA)		■	■	■	■	■
Load types	Static/ Quasi-static	■	■	■	■	■
	2D	■	■	■	■	■
	3D*		■	■	■	■
	Seismic C1					■
	Seismic C2					
	Fatigue**		■	■	■	■
	Fire tested	■	■	■	■	■
	Shock resistance					
Materials	Steel galvanized					
	Hot dip galvanized	■	■	■	■	■
	Stainless steel A2					
	Stainless steel A4	■	■	■		
	HCR steel					
Profis Anchor Channel		■	■	■	■	■

\* HDG channels only.

\*\* HDG channels only. HAC-C hot rolled: HAC-C 52/34 only; HAC and HAC-V: all channels except HAC-(V)-T50 and HAC-(V)-T70

## 2. CHEMICAL ANCHORS

### 2.1 Concrete

#### 2.1.1 HIT-HY 200 R V3

Note:

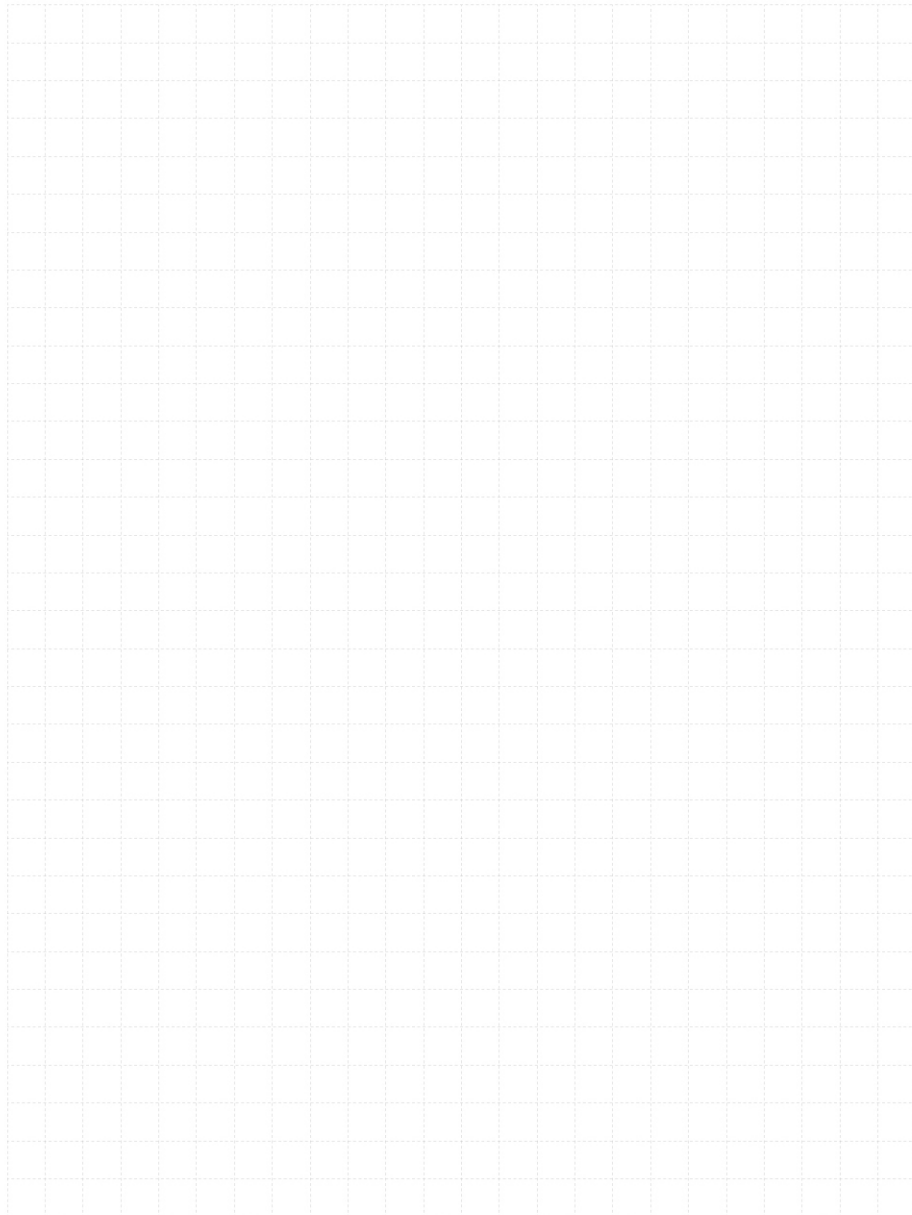

# HIT-HY 200-R V3 injection mortar

## Anchor design (EN 1992-4) / Rods and Sleeves / Concrete

### Injection mortar system



Hilti HIT-HY 200-R V3

500 ml foil pack  
(also available as 330 ml foil pack)



Anchor rod:  
HAS-U  
HAS-U HDG  
HAS-U A4  
HAS-U HCR  
(M8-M30)



Internally threaded sleeve:  
HIS-N  
HIS-RN  
(M8-M20)



Anchor rod:  
HIT-Z  
HIT-Z-F  
HIT-Z-R  
(M8-M20)



Anchor rod:  
HAS-D  
(M12-M20)

### Benefits

- **SafeSet** technology: Simplified method of borehole preparation using either Hilti hollow drill bit for hammer drilling or Roughening tool for diamond cored applications
- Suitable for uncracked and cracked concrete C 20/25 to C 50/60
- ETA Approved for seismic performance category C1, C2<sup>a)</sup>
- Maximum load performance in cracked concrete and uncracked concrete
- High corrosion / corrosion resistance<sup>b)</sup>
- Small edge distance and anchor spacing possible
- Manual cleaning for borehole diameter up to 20mm and  $h_{ef} \leq 10d$  for uncracked concrete only
- 100 years service lifetime resistance

### Base material



Concrete (uncracked)



Concrete (cracked)



Dry concrete

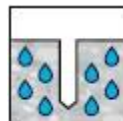

Wet concrete



Hilti **SafeSet** technology



Diamond drilled holes<sup>c)</sup>

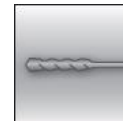

Hammer drilled holes

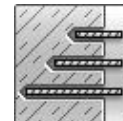

Variable embedment depth

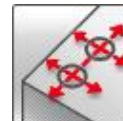

Small edge distance and spacing

### Load conditions



Static/  
quasi-static



Seismic,  
ETA-C1,  
C2<sup>a)</sup>

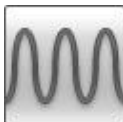

Fatigue  
ETA<sup>d)</sup>



European  
Technical  
Assessment



100 Years  
Design  
Life



CE  
conformity



Corrosion  
resistance<sup>b)</sup>



High  
corrosion  
resistance<sup>b)</sup>



PROFIS  
Engineering  
design  
Software

### Other information

- a) HIS-N internally threaded sleeves not approved for Seismic.  
 b) High Corrosion resistant rods available only for HAS-U. Corrosion resistant rods available for HAS-U and HIS-N.  
 c) Diamond drilling only with Roughening Tool (RT) for HAS-U and HIS-N.  
 d) Only for HAS-D rods.

### Approvals / certificates

Description	Product	Authority /	No. / date of issue
European Technical Assessment	HY 200-R V3	DIBt, Berlin	ETA-19/0601 / 2021-12-02
European Technical Assessment	HY 200-R V3	DIBt, Berlin	ETA-19/0632 / 2020-10-28

- a) All data given in this section according to the ETA-19/0601, issue 2021-12-02.  
 b) All data given in this section according to the ETA-19/0601, issue 2020-10-28.

**Static and quasi-static resistance (for a single anchor)**
**All data in this section applies to:**

- Correct setting (See setting instruction)
- No edge distance and spacing influence
- Steel failure
- Minimum base material thickness
- Embedment depth, as specified in the table
- Anchor material, as specified in the tables
- Concrete C 20/25,  $f_{ck,cube} = 25 \text{ N/mm}^2$
- in-service temperature range I  
(min. base material temp.  $-40^\circ\text{C}$ , max. long/short term base material temp.:  $+24^\circ\text{C}/40^\circ\text{C}$ )
- Short term loading. For long term loading please apply  $\psi_{sus} = 0.74$ .

**For hammer drilled holes, hammer drilled holes with Hilti hollow drill bit:**
**Embedment depth <sup>1)</sup> and base material thickness**

Anchor size			M8	M10	M12	M16	M20	M24	M27	M30
<b>HAS-U</b>										
Embedment depth	$h_{ef}$	[mm]	80	90	110	125	170	210	240	270
Base material thickness	$h$	[mm]	110	120	140	160	220	270	300	340
<b>HIS-N</b>										
Embedment depth	$h_{ef}$	[mm]	90	110	125	170	205	-	-	-
Base material thickness	$h$	[mm]	120	150	170	230	270	-	-	-
<b>HIT-Z</b>										
Embedment depth	$h_{ef}$	[mm]	70	90	110	145	180	-	-	-
Base material thickness	$h$	[mm]	130	150	170	245	280	-	-	-
<b>HAS-D</b>										
Embedment depth	$h_{ef}$	[mm]	-	-	100	125	170	-	-	-
Base material thickness	$h$	[mm]	-	-	130	160	220	-	-	-

1) The allowed range of embedment depth is shown in the setting details.

**Characteristic resistance**

Anchor size		M8	M10	M12	M16	M20	M24	M27	M30		
<b>Uncracked concrete</b>											
Tension	HAS-U 5.8	N <sub>Rk</sub>	[kN]	18,3	29,0	42,2	68,7	109,0	149,7	182,9	218,2
	HAS-U 8.8			29,3	42,0	56,8	68,7	109,0	149,7	182,9	218,2
	HAS-U A4			25,6	40,6	56,8	68,7	109,0	149,7	182,9	218,2
	HAS-U HCR			29,3	42,0	56,8	68,7	109,0	149,7	182,9	218,2
	HIS-N 8.8			25,0	46,0	67,0	109,0	116	-	-	-
	HIT-Z <sup>a)</sup>			24,0	38,0	50,0	85,9	118,8	-	-	-
	HAS-D			-	-	49,2	68,8	109,0	-	-	-
Shear	HAS-U 5.8	V <sub>Rk</sub>	[kN]	11,0	17,4	25,3	47,1	73,5	105,9	137,7	168,3
	HAS-U 8.8			14,6	23,2	33,7	62,8	98,0	141,2	183,6	224,4
	HAS-U A4			12,8	20,3	29,5	55,0	85,8	123,6	114,8	140,3
	HAS-U HCR			14,6	23,2	33,7	62,8	98,0	123,6	160,7	196,4
	HIS-N 8.8			13,0	23,0	34,0	63,0	58,0	-	-	-
	HIT-Z <sup>a)</sup>			12,0	19,0	27,0	48,0	73,0	-	-	-
	HAS-D			-	-	34,0	63,0	149,0	-	-	-
<b>Cracked concrete</b>											
Tension	HAS-U 5.8	N <sub>Rk</sub>	[kN]	15,1	21,2	35,2	48,1	76,3	104,8	128,0	152,8
	HAS-U 8.8			15,1	21,2	35,2	48,1	76,3	104,8	128,0	152,8
	HAS-U A4			15,1	21,2	35,2	48,1	76,3	104,8	128,0	152,8
	HAS-U HCR			15,1	21,2	35,2	48,1	76,3	104,8	128,0	152,8
	HIS-N 8.8			24,7	39,7	48,1	76,3	101,1	-	-	-
	HIT-Z <sup>a)</sup>			20,2	29,4	39,7	60,1	83,2	-	-	-
	HAS-D			-	-	34,4	48,1	76,3	-	-	-
Shear	HAS-U 5.8	V <sub>Rk</sub>	[kN]	11,0	17,4	25,3	47,1	73,5	105,9	137,7	168,3
	HAS-U 8.8			14,6	23,2	33,7	62,8	98,0	141,2	183,6	224,4
	HAS-U A4			12,8	20,3	29,5	55,0	85,8	123,6	114,8	140,3
	HAS-U HCR			14,6	23,2	33,7	62,8	98,0	123,6	160,7	196,4
	HIS-N 8.8			13,0	23,0	34,0	63,0	58,0	-	-	-
	HIT-Z <sup>a)</sup>			12,0	19,0	27,0	48,0	73,0	-	-	-
	HAS-D			-	-	34,0	63,0	149,0	-	-	-

a) Hilti anchor rod HIT-Z-F: M16 and M20.

**Design resistance**

Anchor size		M8	M10	M12	M16	M20	M24	M27	M30		
<b>Uncracked concrete</b>											
Tension	HAS-U 5.8	N <sub>Rd</sub>	[kN]	12,2	19,3	28,1	45,8	72,7	99,8	121,9	145,5
	HAS-U 8.8			19,5	28,0	37,8	45,8	72,7	99,8	121,9	145,5
	HAS-U A4			13,7	21,7	31,6	45,8	72,7	99,8	80,2	98,1
	HAS-U HCR			19,5	28,0	37,8	45,8	72,7	99,8	121,9	145,5
	HIS-N 8.8			16,7	30,7	44,7	72,7	77,3	-	-	-
	HIT-Z <sup>a)</sup>			16,0	25,3	33,3	57,3	79,2	-	-	-
	HAS-D			-	-	32,8	45,8	72,7	-	-	-
Shear	HAS-U 5.8	V <sub>Rd</sub>	[kN]	8,8	13,9	20,2	37,7	58,8	84,7	110,2	134,6
	HAS-U 8.8			11,7	18,6	27,0	50,2	78,4	113,0	146,9	179,5
	HAS-U A4			8,2	13,0	18,9	35,2	55,0	79,2	48,2	58,9
	HAS-U HCR			11,7	18,6	27,0	50,2	78,4	70,6	91,8	112,2
	HIS-N 8.8			10,4	18,4	27,2	50,4	46,4	-	-	-
	HIT-Z <sup>a)</sup>			9,6	15,2	21,6	38,4	58,4	-	-	-
	HAS-D			-	-	27,2	50,4	119,2	-	-	-
<b>Cracked concrete</b>											
Tension	HAS-U 5.8	N <sub>Rd</sub>	[kN]	10,0	14,1	23,5	32,1	50,9	69,9	85,4	101,8
	HAS-U 8.8			10,0	14,1	23,5	32,1	50,9	69,9	85,4	101,8
	HAS-U A4			10,0	14,1	23,5	32,1	50,9	69,9	80,2	98,1
	HAS-U HCR			10,0	14,1	23,5	32,1	50,9	69,9	85,4	101,8
	HIS-N 8.8			16,5	26,5	32,1	50,9	67,4	-	-	-
	HIT-Z <sup>a)</sup>			13,4	19,6	26,5	40,1	55,4	-	-	-
	HAS-D			-	-	22,9	32,1	50,9	-	-	-
Shear	HAS-U 5.8	V <sub>Rd</sub>	[kN]	8,8	13,9	20,2	37,7	58,8	84,7	110,2	134,6
	HAS-U 8.8			11,7	18,6	27,0	50,2	78,4	113,0	146,9	179,5
	HAS-U A4			8,2	13,0	18,9	35,2	55,0	79,2	48,2	58,9
	HAS-U HCR			11,7	18,6	27,0	50,2	78,4	70,6	91,8	112,2
	HIS-N 8.8			10,4	18,4	27,2	50,4	46,4	-	-	-
	HIT-Z <sup>a)</sup>			9,6	15,2	21,6	38,4	58,4	-	-	-
	HAS-D			-	-	27,2	50,4	101,8	-	-	-

a) Hilti anchor rod HIT-Z-F: M16 and M20.

**Recommended loads <sup>b)</sup>**

Anchor size		M8	M10	M12	M16	M20	M24	M27	M30		
<b>Uncracked concrete</b>											
Tension	HAS-U 5.8	N <sub>Rd</sub>	[kN]	8,7	13,8	20,1	32,7	51,9	71,3	87,1	103,9
	HAS-U 8.8			13,9	20,0	27,0	32,7	51,9	71,3	87,1	103,9
	HAS-U A4			9,8	15,5	22,5	32,7	51,9	71,3	57,3	70,1
	HAS-U HCR			13,9	20,0	27,0	32,7	51,9	71,3	87,1	103,9
	HIS-N 8.8			11,9	21,9	31,9	51,9	55,2	-	-	-
	HIT-Z <sup>a)</sup>			11,4	18,1	23,8	40,9	56,6	-	-	-
	HAS-D			-	-	23,4	32,7	51,9	-	-	-
Shear	HAS-U 5.8	V <sub>Rd</sub>	[kN]	6,3	9,9	14,5	26,9	42,0	60,5	78,7	96,2
	HAS-U 8.8			8,4	13,3	19,3	35,9	56,0	80,7	104,9	128,2
	HAS-U A4			5,9	9,3	13,5	25,2	39,3	56,6	34,4	42,1
	HAS-U HCR			8,4	13,3	19,3	35,9	56,0	50,4	65,6	80,1
	HIS-N 8.8			7,4	13,1	19,4	36,0	33,1	-	-	-
	HIT-Z <sup>a)</sup>			6,9	10,9	15,4	27,4	41,7	-	-	-
	HAS-D			-	-	19,4	36,0	85,1	-	-	-
<b>Cracked concrete</b>											
Tension	HAS-U 5.8	N <sub>Rd</sub>	[kN]	7,2	10,1	16,8	22,9	36,3	49,9	61,0	72,7
	HAS-U 8.8			7,2	10,1	16,8	22,9	36,3	49,9	61,0	72,7
	HAS-U A4			7,2	10,1	16,8	22,9	36,3	49,9	57,3	70,1
	HAS-U HCR			7,2	10,1	16,8	22,9	36,3	49,9	61,0	72,7
	HIS-N 8.8			11,8	18,9	22,9	36,3	48,1	-	-	-
	HIT-Z <sup>a)</sup>			9,6	14,0	18,9	28,6	39,6	-	-	-
	HAS-D			-	-	16,4	22,9	36,3	-	-	-
Shear	HAS-U 5.8	V <sub>Rd</sub>	[kN]	6,3	9,9	14,5	26,9	42,0	60,5	78,7	96,2
	HAS-U 8.8			8,4	13,3	19,3	35,9	56,0	80,7	104,9	128,2
	HAS-U A4			5,9	9,3	13,5	25,2	39,3	56,6	34,4	42,1
	HAS-U HCR			8,4	13,3	19,3	35,9	56,0	50,4	65,6	80,1
	HIS-N 8.8			7,4	13,1	19,4	36,0	48,1	-	-	-
	HIT-Z <sup>a)</sup>			6,9	10,9	15,4	27,4	41,7	-	-	-
	HAS-D			-	-	19,4	36,0	72,7	-	-	-

a) Hilti anchor rod HIT-Z-F: M16 and M20;

b) With overall partial safety factor for action  $\gamma = 1,4$ . The partial safety factors for action depend on the type of loading and shall be taken from national regulations.

**Seismic resistance (for a single anchor)**
**All data in this section applies to:**

- Correct setting (See setting instruction with hammer drilling)
- No edge distance and spacing influence
- Steel failure
- Minimum base material thickness
- Concrete C 20/25,  $f_{ck,cube} = 25 \text{ N/mm}^2$
- Temperature range I (min. base material temp.  $-40^\circ\text{C}$ , max. long/short term base material temp.:  $+24^\circ\text{C}/40^\circ\text{C}$ )
- Installation temperature range  $-10^\circ\text{C}$  to  $+40^\circ\text{C}$  (for HAS-U) or  $+5^\circ\text{C}$  to  $+40^\circ\text{C}$  (for HIT-Z)
- $\alpha_{gap} = 1,0$  (using Hilti seismic filling set) or  $\alpha_{gap} = 0,5$  (without using Hilti seismic filling set) accordingly

**For hammer drilled holes and hammer drilled holes with Hilti hollow drill bit:**
**Anchorage depth for seismic C2**

Anchor size			M8	M10	M12	M16	M20	M24	M27	M30
<b>HAS-U</b>										
Embedment depth	$h_{ef}$	[mm]	-	-	-	125	170	210	-	-
Base material thickness	$h$	[mm]	-	-	-	160	220	270	-	-
<b>HIT-Z</b>										
Embedment depth	$h_{ef}$	[mm]	-	-	110	145	180	-	-	-
Base material thickness	$h$	[mm]	-	-	170	245	280	-	-	-

**Characteristic resistance in case of seismic performance category C2**

Anchor size			M8	M10	M12	M16	M20	M24	M27	M30
Tension	HAS-U 8.8	$N_{Rk,seis}$ [kN]	-	-	-	24,5	45,9	55,4	-	-
	HIT-Z <sup>a)</sup>		-	-	22,0	51,1	70,7	-	-	-
<b>with Hilti filling set</b>										
Shear	HAS-U 8.8	$V_{Rk,seis}$ [kN]	-	-	-	46,0	77,0	103,0	-	-
	HIT-Z <sup>a)</sup>		-	-	23,0	41,0	61,0	-	-	-
<b>without Hilti filling set</b>										
Shear	HAS-U 8.8	$V_{Rk,seis}$ [kN]	-	-	-	20,0	35,5	45,0	-	-
	HIT-Z <sup>a)</sup>		-	-	10,5	18,0	27,5	-	-	-

a) Hilti anchor rod HIT-Z-F: M16 and M20.

**Characteristic resistance in case of seismic performance category C2**

Anchor size			M8	M10	M12	M16	M20	M24	M27	M30
Tension	HAS-U 8.8	$N_{Rd,seis}$ [kN]	-	-	-	16,3	30,6	36,9	-	-
	HIT-Z <sup>a)</sup>		-	-	14,7	34,1	47,1	-	-	-
<b>with Hilti filling set</b>										
Shear	HAS-U 8.8	$V_{Rd,seis}$ [kN]	-	-	-	36,8	61,6	82,4	-	-
	HIT-Z <sup>a)</sup>		-	-	18,4	32,8	48,8	-	-	-
<b>without Hilti filling set</b>										
Shear	HAS-U 8.8	$V_{Rd,seis}$ [kN]	-	-	-	16,0	28,4	36,0	-	-
	HIT-Z <sup>a)</sup>		-	-	8,4	14,4	22,0	-	-	-

a) Hilti anchor rod HIT-Z-F: M16 and M20.



**Anchorage depth for seismic C1**

Anchor size			M8	M10	M12	M16	M20	M24	M27	M30
<b>HAS-U</b>										
Embedment depth	$h_{ef}$	[mm]	-	90	110	125	170	210	240	270
Base material thickness	$h$	[mm]	-	120	140	160	220	270	300	340
<b>HIT-Z</b>										
Embedment depth	$h_{ef}$	[mm]	70	90	110	145	180	-	-	-
Base material thickness	$h$	[mm]	130	150	170	245	280	-	-	-

**Characteristic resistance in case of seismic performance category C1**

Anchor size			M8	M10	M12	M16	M20	M24	M27	M30
Tension	HAS-U 8.8	$N_{Rk,seis}$ [kN]	-	14,7	29,0	40,9	64,9	89,1	108,8	129,9
	HIT-Z <sup>a)</sup> ; HIT-Z-R		17,1	25,0	33,8	51,1	70,7	-	-	-
<b>with Hilti filling set</b>										
Shear	HAS-U 8.8	$V_{Rk,seis}$ [kN]	-	23,2	33,7	62,8	98,0	141,2	183,6	224,4
	HIT-Z <sup>a)</sup>		8,5	12,0	16,0	28,0	45,0	-	-	-
	HIT-Z-R		9,8	15,0	22,0	31,0	48,0	-	-	-
<b>without Hilti filling set</b>										
Shear	HAS-U 8.8	$V_{Rk,seis}$ [kN]	-	11,6	16,9	31,4	49,0	70,6	91,8	112,2
	HIT-Z <sup>a)</sup>		4,3	6,0	8,0	14,0	22,5	-	-	-
	HIT-Z-R		4,9	7,5	11,0	15,5	24,0	-	-	-

a) Hilti anchor rod HIT-Z-F: M16 and M20.

**Design resistance in case of seismic performance category C1**

Anchor size			M8	M10	M12	M16	M20	M24	M27	M30
Tension	HAS-U 8.8	$N_{Rd,seis}$ [kN]	-	9,8	19,4	27,3	43,3	59,4	72,6	86,6
	HIT-Z <sup>a)</sup> ; HIT-Z-R		11,4	16,7	22,5	34,1	47,1	-	-	-
<b>with Hilti filling set</b>										
Shear	HAS-U 8.8	$V_{Rd,seis}$ [kN]	-	18,6	27,0	50,2	78,4	113,0	146,9	179,5
	HIT-Z <sup>a)</sup>		6,8	9,6	12,8	22,4	36,0	-	-	-
	HIT-Z-R		7,8	12,0	17,6	24,8	38,4	-	-	-
<b>without Hilti filling set</b>										
Shear	HAS-U 8.8	$V_{Rd,seis}$ [kN]	-	9,3	13,5	25,1	39,2	56,5	73,4	89,8
	HIT-Z <sup>a)</sup>		3,4	4,8	6,4	11,2	18,0	-	-	-
	HIT-Z-R		3,9	6,0	8,8	12,4	19,2	-	-	-

a) Hilti anchor rod HIT-Z-F: M16 and M20.

**Materials**
**Mechanical properties for HAS-U**

Anchor size				M8	M10	M12	M16	M20	M24	M27	M30
Nominal tensile strength	HAS-U 5.8	$f_{uk}$ [N/mm <sup>2</sup> ]		500	500	500	500	500	500	-	-
	HAS-U 8.8 (HDG) AM 8.8 (HDG)			800	800	800	800	800	800	800	800
	HAS-U A4			700	700	700	700	700	700	500	500
	HAS-U HCR			800	800	800	800	800	700	-	-
Yield strength	HAS-U 5.8	$f_{yk}$ [N/mm <sup>2</sup> ]		440	440	440	440	400	400	-	-
	HAS-U 8.8 (HDG) AM 8.8 (HDG)			640	640	640	640	640	640	640	640
	HAS-U A4			450	450	450	450	450	450	210	210
	HAS-U HCR			640	640	640	640	640	400	-	-
Stressed cross-section	HAS-U	$A_s$ [mm <sup>2</sup> ]	36,6	58,0	84,3	157	245	353	459	561	
Moment of resistance	HAS-U	$W$ [mm <sup>3</sup> ]	31,2	62,3	109	277	541	935	1387	1874	

**Mechanical properties for HIS-N**

Anchor size				M8	M10	M12	M16	M20
Nominal tensile strength	HIS-N	$f_{uk}$ [N/mm <sup>2</sup> ]		490	490	490	490	490
	Screw 8.8			800	800	800	800	800
	HIS-RN			700	700	700	700	700
	Screw A4-70			700	700	700	700	700
Yield strength	HIS-N	$f_{yk}$ [N/mm <sup>2</sup> ]		390	390	390	390	390
	Screw 8.8			640	640	640	640	640
	HIS-RN			350	350	350	350	350
	Screw A4-70			450	450	450	450	450
Stressed cross-section	HIS-(R)N	$A_s$ [mm <sup>2</sup> ]		51,5	108	169	256	238
	Screw			36,6	58,0	84,3	157	245
Moment of resistance	HIS-(R)N	$W$ [mm <sup>3</sup> ]		145	430	840	1595	1543
	Screw			31,2	62,3	109	277	541

**Mechanical properties for HIT-Z**

Anchor size				M8	M10	M12	M16	M20
Nominal tensile strength	HIT-Z(-F) <sup>a)</sup>	$f_{uk}$ [N/mm <sup>2</sup> ]		650	650	650	610	595
	HIT-Z-R			650	650	650	610	595
Yield strength	HIT-Z(-F) <sup>a)</sup>	$f_{yk}$ [N/mm <sup>2</sup> ]		520	520	520	490	480
	HIT-Z-R			520	520	520	490	480
Stressed cross-section of thread	HIT-Z(-F) <sup>a)</sup> HIT-Z-R	$A_s$ [mm <sup>2</sup> ]		36,6	58,0	84,3	157	245
Moment of resistance	HIT-Z(-F) <sup>a)</sup> HIT-Z-R	$W$ [mm <sup>3</sup> ]		31,9	62,5	109,7	278	542

a) Hilti anchor rod HIT-Z-F: M16 and M20.

**Material quality for HAS-U**

Part	Material
<b>Zinc coated steel</b>	
Threaded rod, HAS-U 5.8 (HDG)	Strength class 5.8; Elongation at fracture A5 > 8% ductile Electroplated zinc coated $\geq 5\mu\text{m}$ ; (HDG) hot dip galvanized $\geq 45\mu\text{m}$
Threaded rod, HAS-U 8.8 (HDG)	Strength class 8.8; Elongation at fracture A5 > 12% ductile Electroplated zinc coated $\geq 5\mu\text{m}$ ; (HDG) hot dip galvanized $\geq 45\mu\text{m}$
Hilti Meter rod, AM 8.8 (HDG)	Strength class 8.8; Elongation at fracture A5 > 12% ductile Electroplated zinc coated $\geq 5\mu\text{m}$ , (HDG) hot dip galvanized $\geq 45\mu\text{m}$
Washer	Electroplated zinc coated $\geq 5\mu\text{m}$ , hot dip galvanized $\geq 45\mu\text{m}$
Nut	Strength class of nut adapted to strength class of threaded rod. Electroplated zinc coated $\geq 5\mu\text{m}$ , (HDG) hot dip galvanized $\geq 45\mu\text{m}$
Hilti Filling set (F)	Filling washer: Electroplated zinc coated $\geq 5\mu\text{m}$ / (HDG) Hot dip galvanized $\geq 45\mu\text{m}$ Spherical washer: Electroplated zinc coated $\geq 5\mu\text{m}$ / (HDG) Hot dip galvanized $\geq 45\mu\text{m}$ Lock nut: Electroplated zinc coated $\geq 5\mu\text{m}$ / (HDG) Hot dip galvanized $\geq 45\mu\text{m}$
<b>Stainless Steel</b>	
Threaded rod, HAS-U A4	Strength class 70 for $\leq M24$ and strength class 50 for $> M24$ ; Elongation at fracture A5 > 12% ductile Stainless steel 1.4401; 1.4404; 1.4578; 1.4571; 1.4439; 1.4362 EN 10088-1:2014
Washer	Stainless steel 1.4401, 1.4404, 1.4578, 1.4571, 1.4439, 1.4362 EN 10088-1:2014
Nut	Strength class 70 for $\leq M24$ and strength class 50 for $> M24$ ; Stainless steel 1.4401, 1.4404, 1.4578, 1.4571, 1.4439, 1.4362 EN 10088-1:2014
<b>High corrosion resistant steel</b>	
Threaded rod, HAS-U HCR	Strength class 80 for $\leq M20$ and class 70 for $> M20$ , Elongation at fracture A5 > 12% ductile High corrosion resistant steel 1.4529, 1.4565 EN 10088-1:2014
Washer	High corrosion resistant steel 1.4529, 1.4565 EN 10088-1:2014
Nut	Strength class 80 for $\leq M20$ and class 70 for $> M20$ , High corrosion resistant steel 1.4529, 1.4565 EN 10088-1:2014

**Material quality for HIS-N**

Part	Material
HIS-N Int. threaded sleeve	Electroplated zinc coated $\geq 5\mu\text{m}$
HIS-RN Int. threaded sleeve	Stainless steel 1.4401, 1.4571 EN 10088-1:2014

**Material quality for HIT-Z**

Part	Material
Threaded rod HIT-Z	Elongation at fracture > 8% ductile; Electroplated zinc coated $\geq 5\mu\text{m}$
Washer	Electroplated zinc coated $\geq 5\mu\text{m}$
Nut	Strength class of nut adapted to strength class of anchor rod. Electroplated zinc coated $\geq 5\mu\text{m}$
HIT-Z-F	Elongation at fracture > 8% ductile Multilayer coating, ZnNi-galvanized according to DIN 50979:2008-07
Washer	Multilayer coating, ZnNi-galvanized according to DIN 50979:2008-07
Nut	Multilayer coating, ZnNi-galvanized according to DIN 50979:2008-07
HIT-Z-R	Elongation at fracture > 8% ductile; Stainless steel 1.4401, 1.4404 EN 10088-1:2014
Washer	Stainless steel A4 according to EN 10088-1:2014
Nut	Strength class of nut adapted to strength class of anchor rod. Stainless steel 1.4401, 1.4404 EN 10088-1:2014

### Material quality for HAS-D

Part	Material
Fastener	Steel according to EN 10087:1998, galvanized and coated
Sealing washer	Steel, electroplated zinc coated $\geq 5 \mu\text{m}$
Calotte nut	Steel, electroplated zinc coated $\geq 5 \mu\text{m}$
Lock nut	Steel, electroplated zinc coated $\geq 5 \mu\text{m}$

### Setting information

#### Installation temperature:

- $-10 \text{ }^\circ\text{C}$  to  $+40 \text{ }^\circ\text{C}$  (for HAS-U, HAS-D, HIS-N)
- $+5 \text{ }^\circ\text{C}$  to  $+40 \text{ }^\circ\text{C}$  (for HIT-Z, HIT-Z-D)

#### In service temperature range

Hilti HIT-HY 200-R V3 injection mortar with anchor rod HAS-U / HIS-(R)N may be applied in the temperature ranges given below. An elevated base material temperature leads to a reduction of the design bond resistance.

#### Temperature in the base material

Temperature range	Base material temperature	Maximum long term base material temperature	Maximum short term base material temperature
Temperature range I	$-40 \text{ }^\circ\text{C}$ to $+40 \text{ }^\circ\text{C}$	$+24 \text{ }^\circ\text{C}$	$+40 \text{ }^\circ\text{C}$
Temperature range II	$-40 \text{ }^\circ\text{C}$ to $+80 \text{ }^\circ\text{C}$	$+50 \text{ }^\circ\text{C}$	$+80 \text{ }^\circ\text{C}$
Temperature range III	$-40 \text{ }^\circ\text{C}$ to $+120 \text{ }^\circ\text{C}$	$+72 \text{ }^\circ\text{C}$	$+120 \text{ }^\circ\text{C}$

#### Maximum short term base material temperature

Short-term elevated base material temperatures are those that occur over brief intervals, e.g. as a result of diurnal cycling.

#### Maximum long term base material temperature

Long-term elevated base material temperatures are roughly constant over significant periods of time.

#### Curing and working time

Temperature of the base material	HIT-HY 200-R V3	
	Maximum working time	Minimum curing time
$T_{\text{BM}}$	$t_{\text{work}}$	$t_{\text{cure}}$
$-10 \text{ }^\circ\text{C} < T_{\text{BM}} \leq -5 \text{ }^\circ\text{C}$ <sup>a)</sup>	3 h	20 h
$-5 \text{ }^\circ\text{C} < T_{\text{BM}} \leq 0 \text{ }^\circ\text{C}$ <sup>a)</sup>	1,5 h	8 h
$0 \text{ }^\circ\text{C} < T_{\text{BM}} \leq 5 \text{ }^\circ\text{C}$ <sup>a)</sup>	45 min	4 h
$5 \text{ }^\circ\text{C} < T_{\text{BM}} \leq 10 \text{ }^\circ\text{C}$	30 min	2,5 h
$10 \text{ }^\circ\text{C} < T_{\text{BM}} \leq 20 \text{ }^\circ\text{C}$	15 min	1,5 h
$20 \text{ }^\circ\text{C} < T_{\text{BM}} \leq 30 \text{ }^\circ\text{C}$	9 min	1 h
$30 \text{ }^\circ\text{C} < T_{\text{BM}} \leq 40 \text{ }^\circ\text{C}$	6 min	1 h

a) Installation of HIT-Z, HIT-Z-D only in range  $+5 \text{ }^\circ\text{C}$  to  $+40 \text{ }^\circ\text{C}$

**Setting details for HAS-U**

Anchor size			M8	M10	M12	M16	M20	M24	M27	M30
Nominal diameter of drill bit	$d_0$	[mm]	10	12	14	18	22	28	30	35
Effective embedment depth (= drill hole depth) <sup>a)</sup>	$h_{ef,min} = h_0$	[mm]	60	60	70	80	90	96	108	120
	$h_{ef,max} = h_0$	[mm]	160	200	240	320	400	480	540	600
Minimum base material thickness	$h_{min}$	[mm]	$h_{ef} + 30 \text{ mm} \geq 100 \text{ mm}$			$h_{ef} + 2 d_0$				
Maximum diameter of clearance hole in the fixture	$d_f$	[mm]	9	12	14	18	22	26	30	33
Thickness of Hilti filling set	$h_{fs}$	[mm]	-	-	-	11	13	15	-	-
Effective fixture thickness with Hilti filling set	$t_{fix,eff}$	[mm]	$t_{fix} - h_{fs}$							
Maximum torque moment <sup>b)</sup>	$T_{max}$	[Nm]	10	20	40	80	150	200	270	300
Minimum spacing	$s_{min}$	[mm]	40	50	60	75	90	115	120	140
Minimum edge distance	$c_{min}$	[mm]	40	45	45	50	55	60	75	80
Critical spacing for splitting failure	$s_{cr,sp}$	[mm]	$2 C_{cr,sp}$							
Critical edge distance for splitting failure <sup>c)</sup>	$C_{cr,sp}$	[mm]	$1,0 \cdot h_{ef}$		for $h / h_{ef} \geq 2,00$					
			$4,6 h_{ef} - 1,8 h$		for $2,0 > h / h_{ef} > 1,3$					
			$2,26 h_{ef}$		for $h / h_{ef} \leq 1,3$					
Critical spacing for concrete cone failure	$s_{cr,N}$	[mm]	$2 C_{cr,N}$							
Critical edge distance for concrete cone failure	$C_{cr,N}$	[mm]	$1,5 h_{ef}$							

For spacing (edge distance) smaller than critical spacing (critical edge distance) the design loads have to be reduced.

- $h_{ef,min} \leq h_{ef} \leq h_{ef,max}$  ( $h_{ef}$ : embedment depth)
- Maximum recommended torque moment to avoid splitting failure during instalation with minimum spacing and edge distance
- $h$ : base material thickness ( $h \geq h_{min}$ )
- The critical edge distance for concrete cone failure depends on the embedment depth  $h_{ef}$  and the design bond resistance. The simplified formula given in this table is on the save side.

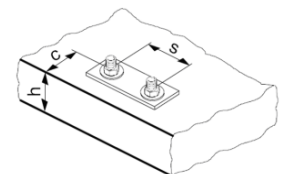
**HAS-U-...**

**Marking:**

Steel grade number and length identification letter: e.g. 8L

**Setting details for HIS-N**

Anchor size		M8	M10	M12	M16	M20
Nominal diameter of drill bit	$d_0$ [mm]	14	18	22	28	32
Diameter of element	$d$ [mm]	12,5	16,5	20,5	25,4	27,6
Effective embedment depth (=drill hole depth)	$h_{ef} = h_0$ [mm]	90	110	125	170	205
Minimum base material thickness	$h_{min}$ [mm]	120	150	170	230	270
Diameter of clearance hole in the fixture	$d_f$ [mm]	9	12	14	18	22
Thread engagement length; min - max	$h_s$ [mm]	8-20	10-25	12-30	16-40	20-50
Maximum torque moment <sup>b)</sup>	$T_{max}$ [Nm]	10	20	40	80	150
Minimum spacing	$s_{min}$ [mm]	60	75	90	115	130
Minimum edge distance	$c_{min}$ [mm]	40	45	55	65	90
Critical spacing for splitting failure	$s_{cr,sp}$ [mm]	$2 c_{cr,sp}$				
Critical edge distance for splitting failure <sup>a)</sup>	$c_{cr,sp}$ [mm]	$1,0 \cdot h_{ef}$ for $h / h_{ef} \geq 2,0$				
		$4,6 h_{ef} - 1,8 h$ for $2,0 > h / h_{ef} > 1,3$				
		$2,26 h_{ef}$ for $h / h_{ef} \leq 1,3$				
Critical spacing for concrete cone failure	$s_{cr,N}$ [mm]	$2 c_{cr,N}$				
Critical edge distance for concrete cone failure	$c_{cr,N}$ [mm]	$1,5 h_{ef}$				

For spacing (edge distance) smaller than critical spacing (critical edge distance) the design loads have to be reduced.

- a) Max. recommended torque moment to avoid splitting failure during Installation with minimum spacing and edge distance
- b)  $h$ : base material thickness ( $h \geq h_{min}$ )
- c) The critical edge distance for concrete cone failure depends on the embedment depth  $h_{ef}$  and the design bond resistance. The simplified formula given in this table is on the same side.

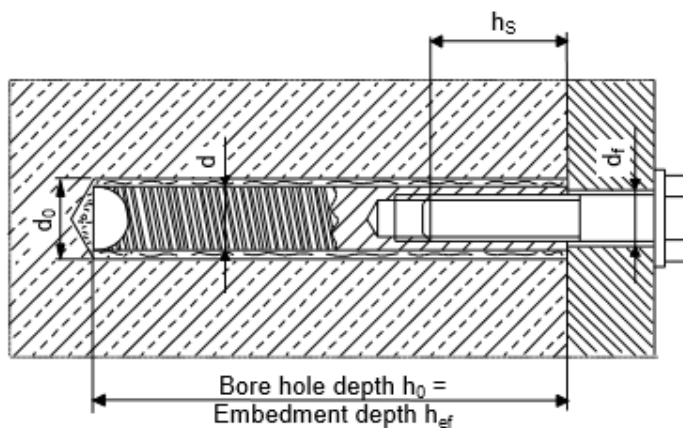
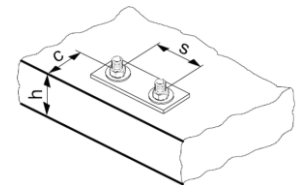

**Setting details for HIT-Z, HIT-Z-F and HIT-Z-R**

Anchor size		M8	M10	M12	M16	M20
Nominal diameter of drill bit	$d_0$ [mm]	10	12	14	18	22
Length of anchor	min l [mm]	80	95	105	155	215
	max l [mm]	120	160	196	420	450
Nominal embedment depth a)	$h_{nom,min}$ [mm]	60	60	60	96	100
	$h_{nom,max}$ [mm]	100	120	144	192	220
Borehole condition 1 Min. base material thickness	$h_{min}$ [mm]	$h_{nom} + 60$ mm			$h_{nom} + 100$ mm	
Borehole condition 2 Min. base material thickness	$h_{min}$ [mm]	$h_{nom} + 30$ mm $\geq 100$ mm			$h_{nom} + 45$ mm	
Maximum depth of drill hole	$h_0$ [mm]	$h - 30$ mm			$h - 2 d_0$	
Pre-setting: Diameter of clearance hole in the fixture	$d_f$ [mm]	9	12	14	18	22
Through-setting: Diameter of clearance hole in the fixture	$d_f$ [mm]	11	14	16	20	24
Maximum fixture thickness	$t_{fix}$ [mm]	48	87	120	303	326
Maximum fixture thickness with seismic filling set	$t_{fix}$ [mm]	41	79	111	292	314
Installation torque moment <sup>b)</sup>	HIT-Z, HIT-Z-F $T_{inst}$ [Nm]	10	25	40	80	150
	HIT-Z-R $T_{inst}$ [Nm]	30	55	75	155	215
Critical spacing for splitting failure	$S_{cr,sp}$ [mm]	$2 C_{cr,sp}$				
Critical edge distance for splitting failure <sup>c)</sup>	$C_{cr,sp}$ [mm]	$1,5 \cdot h_{nom}$ for $h / h_{nom} \geq 2,35$				
		$6,2 h_{nom} - 2,0 h$ for $2,35 > h / h_{nom} > 1,35$				
		$3,5 h_{nom}$ for $h / h_{nom} \leq 1,35$				
Critical spacing for concrete cone failure	$S_{cr,N}$ [mm]	$2 C_{cr,N}$				
Critical edge distance concrete cone failure	$C_{cr,N}$ [mm]	$1,5 h_{nom}$				

For spacing (edge distance) smaller than critical spacing (critical edge distance) the design loads have to be reduced.

a)  $h_{nom,min} \leq h_{nom} \leq h_{nom,max}$  ( $h_{nom}$ : embedment depth).

b) Recommended torque moment to avoid splitting failure during instalation with minimum spacing and edge distance.

c)  $h$ : base material thickness ( $h \geq h_{min}$ ).

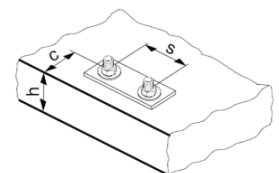

**Pre-setting:**

Install anchor before positioning fixture

**Through-setting:**

Install anchor through positioned fixture

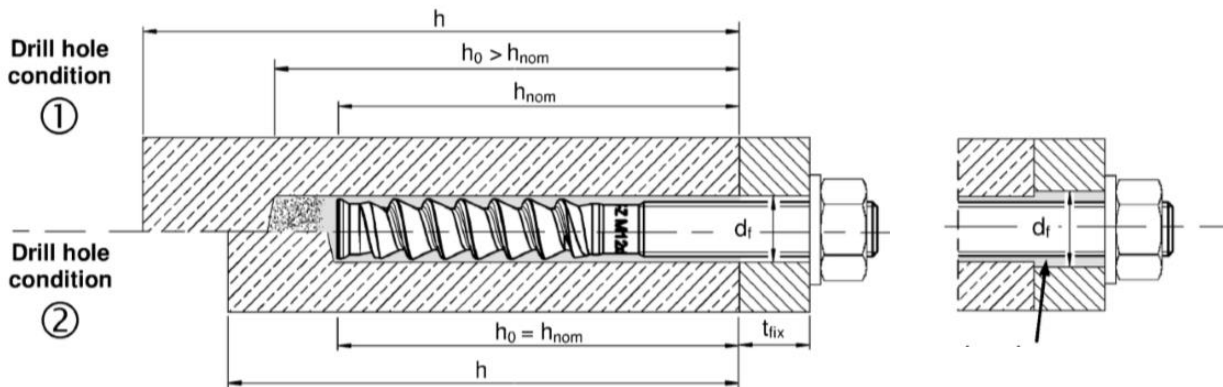

Drill hole condition 1 → non-cleaned borehole  
 Drill hole condition 2 → drilling dust is completely removed

**Anchor dimension for HIT-Z**

Anchor size		M8	M10	M12	M16	M20
Length of anchor	min $\ell$	80	95	105	155	215
	max $\ell$	120	160	196	420	450
Helix length	$\ell_{Helix}$	30 or 50	50 or 60	60	96	100

Combine with another table (setting details)

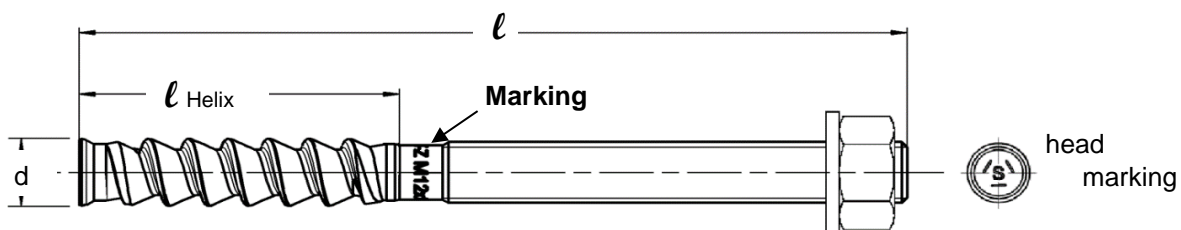
**Minimum edge distance and spacing for HIT-Z**

For the calculation of minimum spacing and minimum edge distance of anchors in combination with different embedment depth and thickness of concrete member the following equation shall be fulfilled:  $A_{i,req} < A_{i,cal}$

**Required interaction area  $A_{i,cal}$  for HIT-Z**

Anchor size		M8	M10	M12	M16	M20
Cracked concrete	[mm <sup>2</sup> ]	19200	40800	58800	94700	148000
Non-cracked concrete	[mm <sup>2</sup> ]	22200	57400	80800	128000	198000

Combine with another table (setting details)

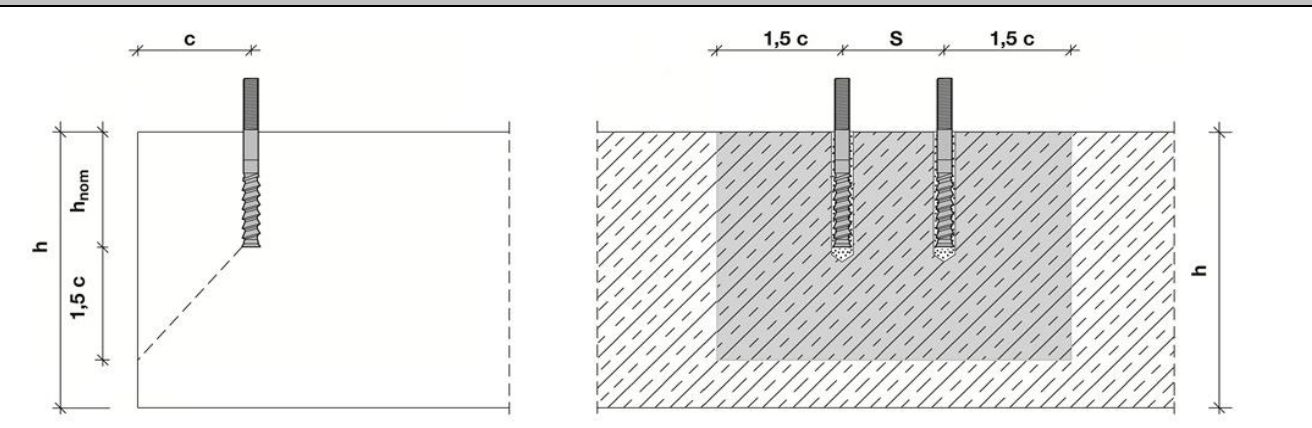

**Effective area  $A_{i,ef}$  of HIT-Z**
**Member thickness  $h \geq h_{nom} + 1,5 \cdot c$** 

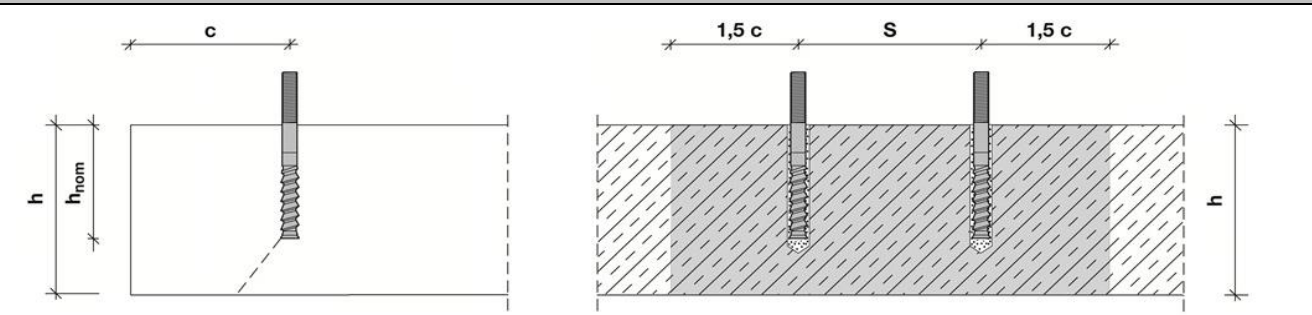
 Single anchor and group of anchors with  $s > 3 \cdot c$  [mm<sup>2</sup>]  $A_{i,cal} = (6 \cdot c) \cdot (h_{nom} + 1,5 \cdot c)$  with  $c \geq 5 \cdot d$ 

 Group of anchors with  $s \leq 3 \cdot c$  [mm<sup>2</sup>]  $A_{i,cal} = (3 \cdot c + s) \cdot (h_{nom} + 1,5 \cdot c)$  with  $c \geq 5 \cdot d$  and  $s \geq 5 \cdot d$ 
**Member thickness  $h \leq h_{nom} + 1,5 \cdot c$** 

 Single anchor and group of anchors with  $s >$  [mm<sup>2</sup>]  $A_{i,cal} = (6 \cdot c) \cdot h$  with  $c \geq 5 \cdot d$ 

 Group of anchors with  $s \leq 3 \cdot c$  [mm<sup>2</sup>]  $A_{i,cal} = (3 \cdot c + s) \cdot h$  with  $c \geq 5 \cdot d$  and  $s \geq$ 
**Best case minimum edge distance and spacing with required member thickness and embedment depth**

Anchor size		M8	M10	M12	M16	M20
<b>Cracked concrete</b>						
Member thickness	$h \geq$ [mm]	140	200	240	300	370
Embedment depth	$h_{nom} \geq$ [mm]	80	120	150	200	220
Minimum spacing	$s_{min}$ [mm]	40	50	60	80	100
Corresponding edge distance	$c \geq$ [mm]	40	55	65	80	100
Minimum edge distance	$c_{min} =$ [mm]	40	50	60	80	100
Corresponding spacing	$s \geq$ [mm]	40	60	65	80	100
<b>Non-cracked concrete</b>						
Member thickness	$h \geq$ [mm]	140	230	270	340	410
Embedment depth	$h_{nom} \geq$ [mm]	80	120	150	200	220
Minimum spacing	$s_{min}$ [mm]	40	50	60	80	100
Corresponding edge distance	$c \geq$ [mm]	40	70	80	100	130
Minimum edge distance	$c_{min}$ [mm]	40	50	60	80	100
Corresponding spacing	$s \geq$ [mm]	40	145	160	160	235

**Best case minimum member thickness and embedment depth with required minimum edge distance and spacing (borehole condition 1)**

Anchor size		M8	M10	M12	M16	M20
<b>Cracked concrete</b>						
Member thickness	$h \geq$ [mm]	120	120	120	196	200
Embedment depth	$h_{nom} \geq$ [mm]	60	60	60	96	100
Minimum spacing	$s_{min}$ [mm]	40	50	60	80	100
Corresponding edge distance	$c \geq$ [mm]	40	100	140	135	215
Minimum edge distance	$c_{min} =$ [mm]	40	60	90	80	125
Corresponding spacing	$s \geq$ [mm]	40	160	220	235	365
<b>Non cracked concrete</b>						
Member thickness	$h \geq$ [mm]	120	120	120	196	200
Embedment depth	$h_{nom} \geq$ [mm]	60	60	60	96	100
Minimum spacing	$s_{min}$ [mm]	40	50	60	80	100
Corresponding edge distance	$c \geq$ [mm]	50	145	200	190	300
Minimum edge distance	$c_{min}$ [mm]	40	80	115	110	165
Corresponding spacing	$s \geq$ [mm]	65	240	330	310	495

**Minimum edge distance and spacing – Explanation**

Minimum edge and spacing geometrical requirements are determined by testing the installation conditions in which two anchors with a given spacing can be set close to an edge without forming a crack in the concrete due to tightening torque.

The HIT-Z boundary conditions for edge and spacing geometry can be found in the tables to the left. If the embedment depth and slab thickness are equal to or greater than the values in the table, then the edge and spacing values may be utilized.

**PROFIS Anchor software is programmed to calculate the referenced equations in order to determine the optimized related minimum edge and spacing based on the following variables:**

<b><u>Cracked or non-cracked concrete</u></b>	For cracked concrete it is assumed that a reinforcement is present which limits the crack width to 0,3 mm, allowing smaller values for minimum edge distance and minimum spacing
<b><u>Anchor diameter</u></b>	For smaller anchor diameter a smaller installation torque is required, allowing smaller values for minimum edge distance and minimum spacing
<b><u>Slab thickness and embedment depth</u></b>	Increasing these values allows smaller values for minimum edge distance and minimum spacing

**Setting details for HAS-D**

Anchor size			M12	M16	M20
Nominal diameter of drill bit	$d_0$	[mm]	14	18	24
Diameter of element	$d = d_{nom}$	[mm]	12	16	20
Effective anchorage depth (=drill hole depth)	$h_{ef} = h_0$	[mm]	100	125	170
Minimum drill hole depth	$h_0$	[mm]	105	133	180
Minimum base material thickness	$h_{min}$	[mm]	130	160 <sup>1)</sup> / 170	220 <sup>1)</sup> / 230
Pre-setting: Maximum diameter of clearance hole in the fixture	$d_f$	[mm]	14	18	24
Through-setting: Maximum diameter of clearance hole in the fixture	$d_f$	[mm]	16	20	26
Fixture thickness	$t_{fix,min}$	[mm]	12	16	20
	$t_{fix,max}$	[mm]	200		
Installation torque moment	$T_{inst}$	[Nm]	30	50	80
Uncracked concrete	Minimum spacing	$s_{min}$	80 <sup>2)</sup>	60	80
	Minimum edge distance	$c_{min}$	55 <sup>2)</sup>	60	80
Cracked concrete	Minimum spacing	$s_{min}$	50	60	80
	Minimum edge distance	$c_{min}$	50	60	80

1) The reverse side of the concrete member shall have no break-through after drilling.

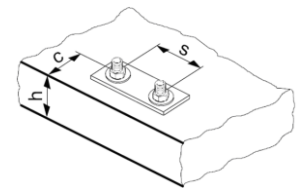
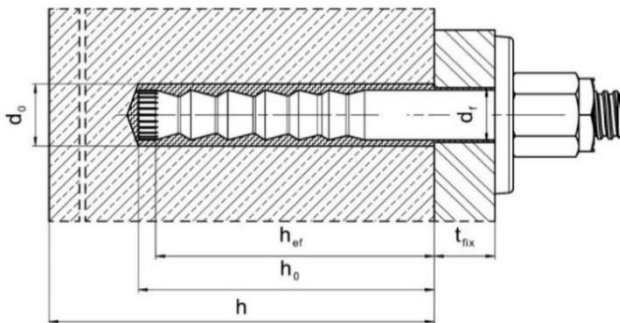
 2) For min. edge distance  $c_{min} \geq 80$  mm, min. spacing  $s_{min} = 55$  mm.

**Anchor dimension for HAS-D**

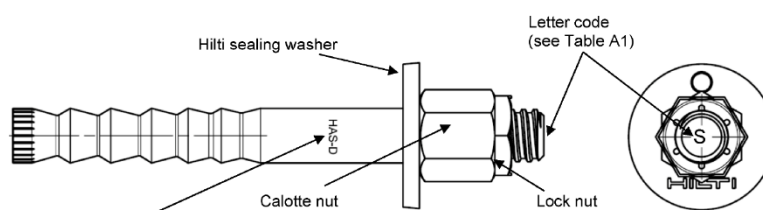
Anchor size			M12	M16	M20
Shaft diameter	$d_k$	[mm]	12,5	16,5	22,0
Fastener length l	$\geq$	[mm]	143	180	242
	$\leq$	[mm]	531	565	623
Calotte nut	SW	[mm]	18/19	24	30
Lock nut	SW	[mm]	19	24	30



**Marking:**  
HAS-D M...x L Bonded expansion anchor type as well as bonded expansion anchor size and length

**Installation equipment**

Anchor size	M8	M10	M12	M16	M20	M24	M27	M30
Rotary hammer	HAS-U, HAS-D	TE 2 – TE 16			TE 40 - TE 80			
	HIT-Z	TE 2 – TE 40		TE 40 – TE 80		-		
	HIS-N	TE (-A) – TE 16(-A)		TE 40 – TE 80		-		
Other tools	blow out pump ( $h_{ef} \leq 10 \cdot d$ , $d_0 \leq 20$ mm) , compressed air gun, set of cleaning brushes, dispenser Hollow Drill Bit							
	roughening tools TE-YRT							
Additional Hilti recommended tools	DD EC-1, DD 100 ... DD 160 <sup>a)</sup>							

a) In case without roughentning – diamond coring is applicable only for HIT-Z installation

**Cleaning, drilling and installation parameters**



HAS-U	HIT-Z, HIT-Z-D <sup>b)</sup>	HAS-D	HIS-N	Drilling				Cleaning and installation	
				Hammer drill (HD)	Hollow Drill Bit (HDB)	Diamond coring		Brush HIT-RB	Piston plug HIT-SZ
						Diamond coring (DD) <sup>c)</sup>	With roughening tool (RT)		
				$d_0$ [mm]				size [mm]	
<b>M8</b>	<b>M8</b>	-	-	10	-	10	-	10	-
<b>M10</b>	<b>M10</b>	-	-	12	12	12	-	12	12
<b>M12</b>	<b>M12</b>	<b>M12</b>	<b>M8</b>	14	14	14	-	14	14
<b>M16</b>	<b>M16</b>	<b>M16</b>	<b>M10</b>	18	18	18	18	18	18
<b>M20</b>	<b>M20</b>	<b>M20</b>	<b>M12</b>	22 / 24 <sup>a)</sup>	22 / 24 <sup>a)</sup>	22 / 24 <sup>a)</sup>	22	22 / 24 <sup>a)</sup>	22 / 24 <sup>a)</sup>
<b>M24</b>	-	-	<b>M16</b>	28	28	28	28	28	28
<b>M27</b>	-	-	-	30	-	30	30	30	30
-	-	-	<b>M20</b>	32	32	32	32	32	32
<b>M30</b>	-	-	-	35	35	35	35	35	35

a) Only for HAS-D.

b) HIT-Z-D only available for M16.

c) Diamond cored holes without roughening can be used only for HIT-Z installation

**Associated components for the use of Hilti Roughening tool TE-YRT**

Diamond coring		Roughening tool TE-YRT	Wear gauge RTG...
			
d <sub>0</sub> [mm]		d <sub>0</sub> [mm]	size
Nominal	measured		
18	17,9 to 18,2	18	18
20	19,9 to 20,2	20	20
22	21,9 to 22,2	22	22
25	24,9 to 25,2	25	25
28	27,9 to 28,2	28	28
30	29,9 to 30,2	30	30
32	31,9 to 32,2	32	32
35	34,9 to 35,2	35	35

**Installation parameters for use of the Hilti Roughening tool TE-YRT**

h <sub>ef</sub> [mm]	Minimum roughening time t <sub>roughen</sub> [sec] (t <sub>roughen</sub> [sec] = h <sub>ef</sub> [mm] / 10)	Minimum blowing time t <sub>blowing</sub> [sec] (t <sub>blowing</sub> [sec] = t <sub>roughen</sub> [sec] + 20)
0 to 100	10	30
101 to 200	20	40
201 to 300	30	50
301 to 400	40	60
401 to 500	50	70
501 to 600	60	80

**Setting instructions for HAS-U rods and HIS-N internally threaded sleeves**

**\*For detailed information on installation see instruction for use given with the package of the product**

**Safety regulations.**

Review the Material Safety Data Sheet (MSDS) before use for proper and safe handling! Wear well-fitting protective goggles and protective gloves when working with Hilti HIT-HY 200-R V3.

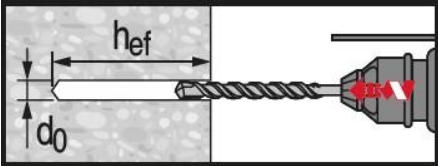
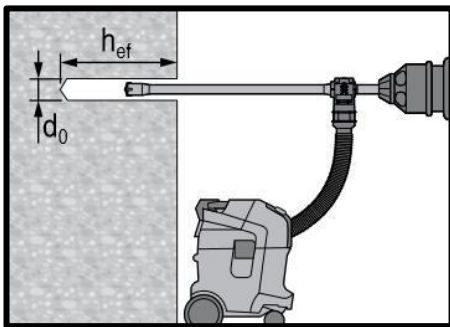
**Drilling**

**Hammer drilled hole (HD)**

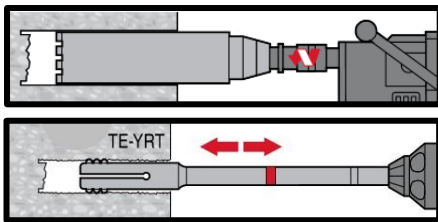
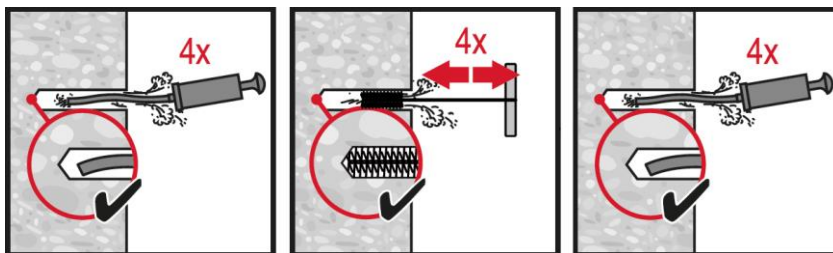
**Hammer drilled hole with Hollow Drilled Bit (HDB)**

No cleaning required

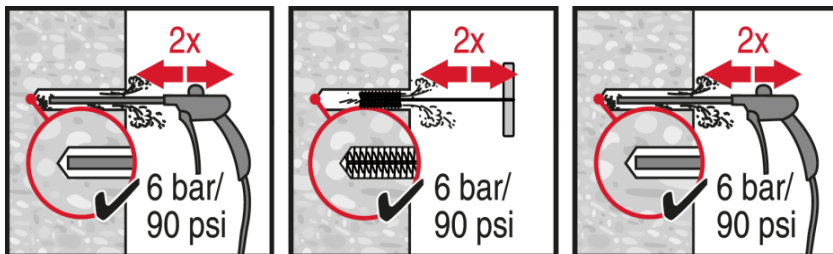
**Diamond Drilling + Roughening Tool (DD+RT)**
**Cleaning**

**Hammer drilling:**
**Manual cleaning (MC)**

for drill diameters  $d_0 \leq 20$  mm and drill hole depth  $h_0 \leq 10 \cdot d$ .

**Hammer drilling:**
**Compressed air cleaning (CAC)**

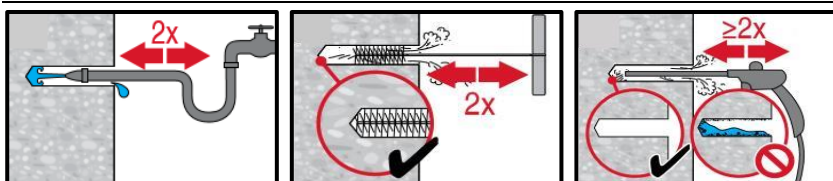
for all drill hole diameters  $d_0$  and drill hole depths  $h_0 \leq 20 \cdot d$ .

**Diamond cored holes with Hilti roughening tool:**

For all drill hole diameters  $d_0$  and drill hole depths  $h_0$ .



**Injection**

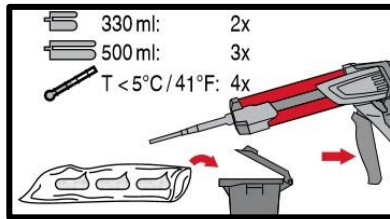
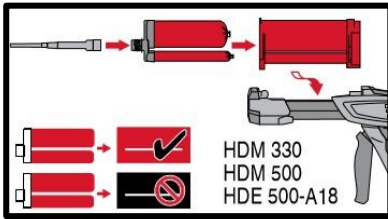

**Injection system preparation.**

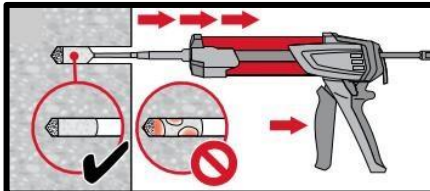
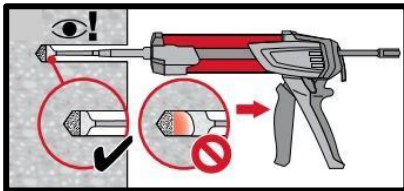

**Injection method for drill hole depth**  
 $h_{ef} \leq 250 \text{ mm.}$

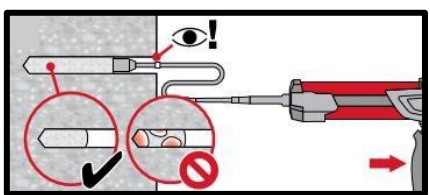
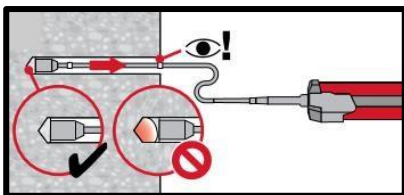

**Injection method for drill hole depth**  
 $h_{ef} > 250 \text{ mm.}$

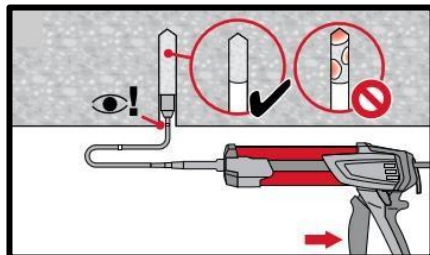
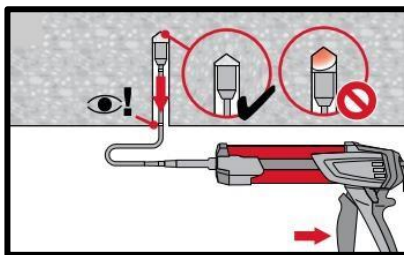

**Injection method for overhead application and/or installation with embedment depth > 250 mm.**

**Setting the element**

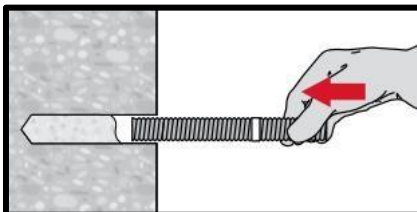

**Setting element**, observe working time "t<sub>work</sub>".

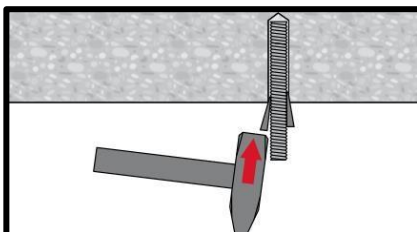

**Setting element** for overhead applications, observe working time "t<sub>work</sub>".

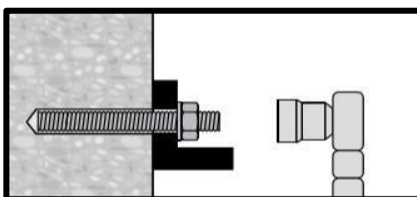

**Loading the anchor** after required curing time t<sub>cure</sub>

## Setting instructions for HIT-Z & HIT-Z(-D) rods

\*For detailed information on installation see instruction for use given with the package of the product.



### Safety regulations.

Review the Material Safety Data Sheet (MSDS) before use for proper and safe handling! Wear well-fitting protective goggles and protective gloves when working with Hilti HIT-HY 200 A (R)

### Drilling

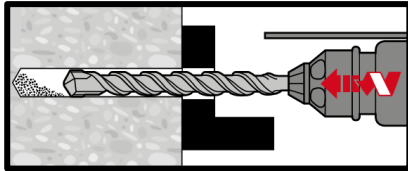

**Hammer drilling: Through-setting**

No cleaning required

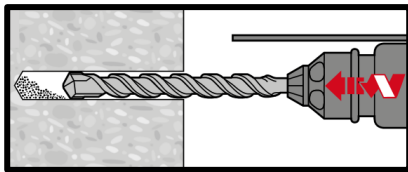

**Hammer drilling: Pre-setting**

No cleaning required

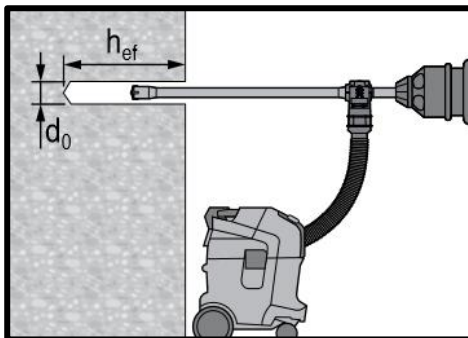

**Hammer drilling with hollow drill bit:  
Through / pre-setting**

No cleaning required

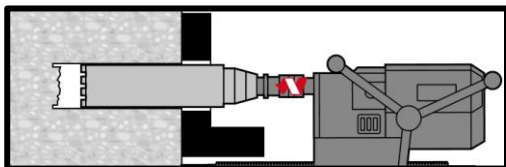

**Diamond coring: Through-setting**

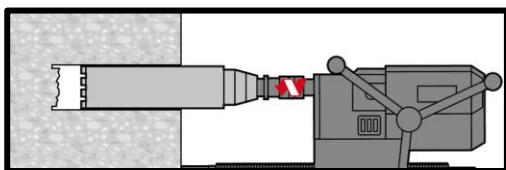

**Diamond coring: Pre-setting**

### Cleaning

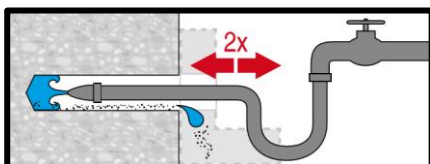

**Hole flushing** required for wet-drilled diamond cored holes.



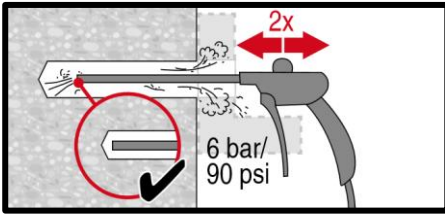

**Evacuation** required for wet-drilled diamond cored holes.

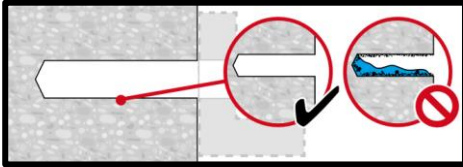

**Injection**

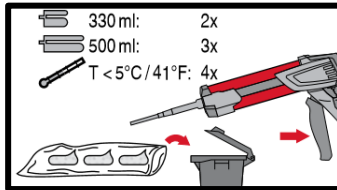
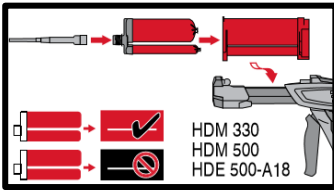

**Injection system preparation.**

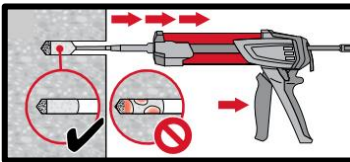
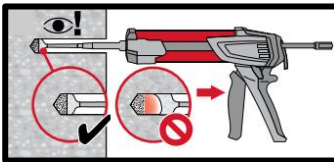

**Injection** of adhesive from the back of the drill hole without forming air voids.

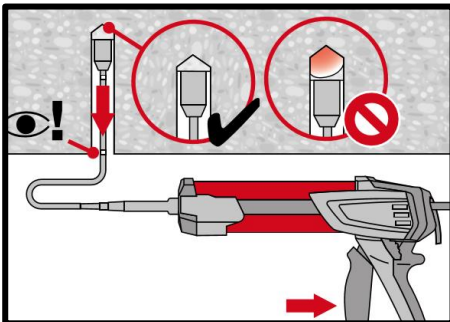

**Overhead installation** only with the aid of extensions and piston plugs.

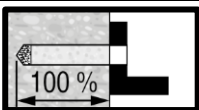

**Through-setting:**

Fill 100% of the drill hole.



**Pre-setting:**

Fill approx. 2/3 of the drill hole.

**Setting the element**

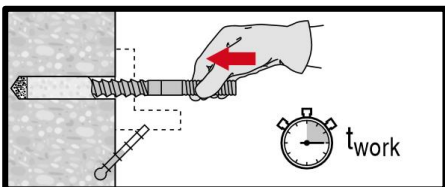

**Setting element** to the required embedment depth before working time "t<sub>work</sub>" has elapsed.

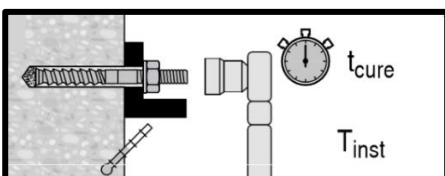

**Loading the anchor:** After required curing time t<sub>cure</sub>.

**Setting instructions for HAS-D rods**

**\*For detailed information on installation see instruction for use given with the package of the product.**

**Safety regulations.**

Review the Material Safety Data Sheet (MSDS) before use for proper and safe handling! Wear well-fitting protective goggles and protective gloves when working with Hilti HIT-HY 200 A (R)

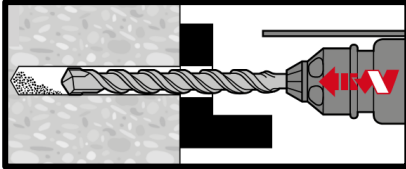
**Drilling**

**Hammer drilling: Through-setting**

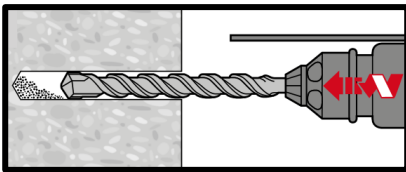

**Hammer drilling: Pre-setting**

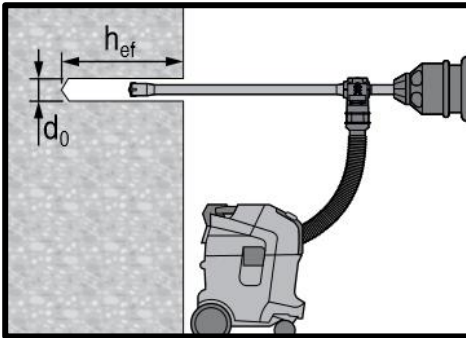

**Hammer drilling with hollow drill bit:  
Through / pre-setting**

No cleaning required

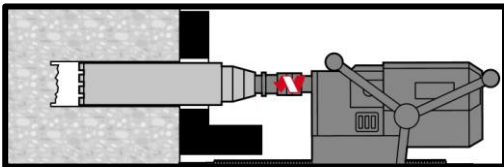

**Diamond coring: Through-setting**

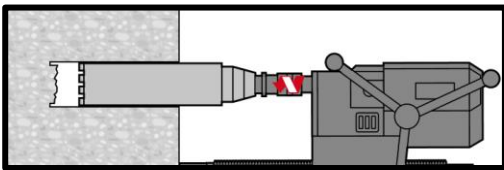

**Diamond coring: Pre-setting**

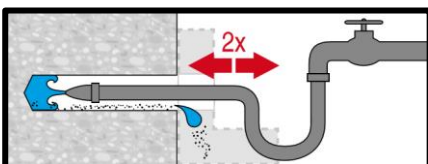
**Cleaning**

**Hole flushing** required for wet-drilled diamond cored holes.

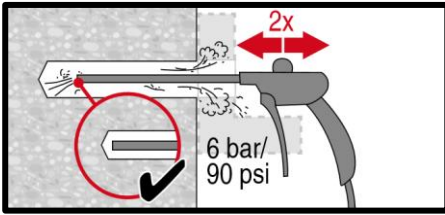

**Evacuation** required for wet-drilled diamond cored holes.

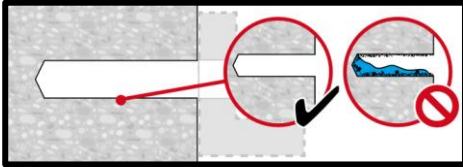

**Injection**

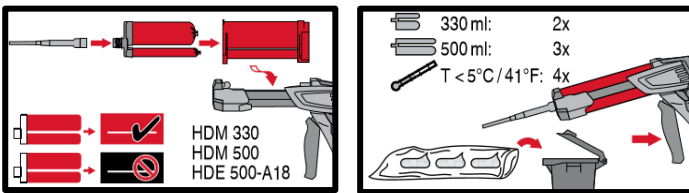

**Injection** system preparation.

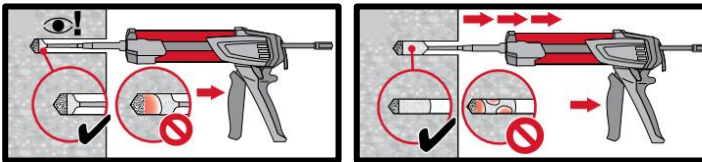

**Injection** of adhesive from the back of the drill hole without forming air voids.

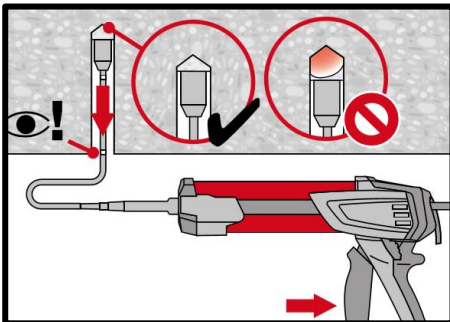

**Overhead installation** only with the aid of extensions and piston plugs.

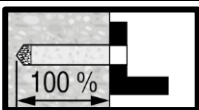

**Through-setting:**

Fill 100% of the drill hole.



**Pre-setting:**

Fill approx. 2/3 of the drill hole.

**Setting the element**

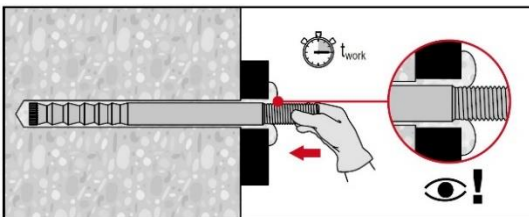

**Setting element** to the required embedment depth before working time "t<sub>work</sub>" has elapsed.

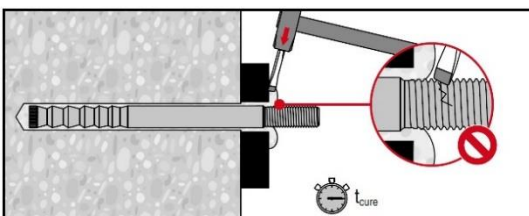

**Removing excess mortar:** After required curing time t<sub>cure</sub>.

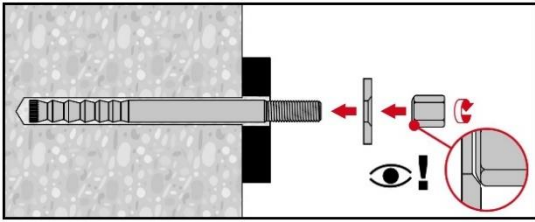
**Final assembly with sealing washer**

**Installation:** Orient the round part of the calotte nut to the sealing washer and install.

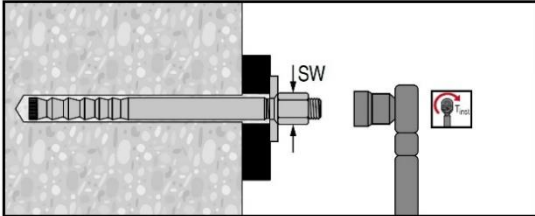

**Installation torque moment**

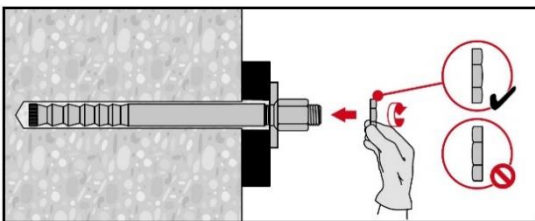

**Applying the lock nut:** Tighten with a  $\frac{1}{4}$  to  $\frac{1}{2}$  turn.

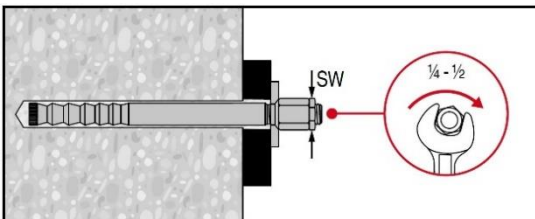

# HIT-HY 200-R V3 injection mortar

Anchor design (EN 1992-4) / Rebar elements / Concrete

## Injection mortar system



Hilti HIT-HY 200-R V3

330 ml foil pack (also available as 500 ml foil pack)



Rebar B500 B (φ8 - φ32)

## Benefits

- **SafeSet** technology: Simplified method of borehole preparation using either Hilti hollow drill bit for hammer drilling or Roughening tool for diamond cored applications
- Assessed following the EAD 330499-00-0601.
- ETA seismic approval C1
- Suitable for cracked and uncracked concrete C 12/15 to C 50/60
- Suitable for dry and water saturated concrete
- In service temperature range up to 120°C short term / 72°C long term
- Large diameter applications

## Base material



Concrete (uncracked)



Concrete (cracked)



Dry concrete

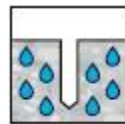

Wet concrete



Static/ quasi-static



Seismic, ETA-C1

**100**  
YEARS

100 Years Design Life

## Load conditions

## Installation conditions



Hammer drilling



Diamond drilled holes<sup>a)</sup>

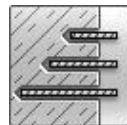

Variable embedment depth



Hilti **SafeSet** technology

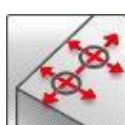

Small edge distance and spacing



European Technical Assessment



CE conformity



PROFIS Engineering design Software

## Other informations

a) Diamond drilling only with Roughening Tool (RT).

## Approvals / certificates

Description	Authority / Laboratory	No. / date of issue
European technical assessment <sup>a)</sup>	DIBt, Berlin	ETA-19/0601 / 2021-12-02

a) All data given in this section according to the ETA-19/0601, issue 2021-12-02.

## Static and quasi-static loading (for a single anchor)

### All data in this section applies to

- Correct setting (See setting instruction)
- No edge distance and spacing influence
- Steel failure
- Base material thickness, as specified in the table
- Embedment depth, as specified in the table
- Anchor material, as specified in the tables
- Concrete C 20/25
- in-service temperate range I  
(min. base material temperature -40°C, max. long term/short term base material temperature: +24°C/40°C)

### Embedment depth <sup>a)</sup> and base material thickness

Anchor- size		φ8	φ10	φ12	φ14	φ16	φ20	φ25	φ26	φ28	φ30	φ32
Embedment depth	$h_{ef}$ [mm]	80	90	110	125	125	170	210	240	270	270	300
Base material thickness	$h$ [mm]	110	120	145	165	165	220	275	305	340	345	380

a) The allowed range of embedment depth is shown in the setting details.

### Characteristic resistance

Anchor- size			φ8	φ10	φ12	φ14	φ16	φ20	φ25	φ26	φ28	φ30	φ32
<b>Non-cracked concrete</b>													
Tensile	Rebar B500B	$N_{Rk}$ [kN]	24,1	33,9	49,8	66,0	68,7	109,0	149,7	182,9	218,2	218,2	255,6
Shear	Rebar B500B	$V_{Rk}$ [kN]	14,0	22,0	31,0	42,0	55,0	86,0	135,0	146,0	169,0	194,0	221,0
<b>Cracked concrete</b>													
Tensile	Rebar B500B	$N_{Rk}$ [kN]	-	14,1	29,0	38,5	44,0	74,8	104,8	128,0	152,8	152,8	178,9
Shear	Rebar B500B	$V_{Rk}$ [kN]	-	22,0	31,0	42,0	55,0	86,0	135,0	146,0	169,0	194,0	221,0

### Design resistance

Anchor- size			φ8	φ10	φ12	φ14	φ16	φ20	φ25	φ26	φ28	φ30	φ32
<b>Non-cracked concrete</b>													
Tensile	Rebar B500B	$N_{Rd}$ [kN]	16,1	22,6	33,2	44,0	45,8	72,7	99,8	121,9	145,5	145,5	170,4
Shear	Rebar B500B	$V_{Rd}$ [kN]	9,3	14,7	20,7	28,0	36,7	57,3	90,0	97,3	112,7	129,3	147,3
<b>Cracked concrete</b>													
Tensile	Rebar B500B	$N_{Rd}$ [kN]	-	9,4	19,4	25,7	29,3	49,8	69,9	85,4	101,8	101,8	119,3
Shear	Rebar B500B	$V_{Rd}$ [kN]	-	14,7	20,7	28,0	36,7	57,3	90,0	97,3	112,7	129,3	147,3

### Recommended loads <sup>a)</sup>

Anchor- size			φ8	φ10	φ12	φ14	φ16	φ20	φ25	φ26	φ28	φ30	φ32
<b>Non-cracked concrete</b>													
Tensile	Rebar B500B	$N_{Rec}$ [kN]	11,5	16,1	23,7	31,4	32,7	51,9	71,3	87,1	103,9	103,9	121,7
Shear	Rebar B500B	$V_{Rec}$ [kN]	6,7	10,5	14,8	20,0	26,2	41,0	64,3	69,5	80,5	92,4	105,2
<b>Cracked concrete</b>													
Tensile	Rebar B500B	$N_{Rec}$ [kN]	-	6,7	13,8	18,3	20,9	35,6	49,9	61,0	72,7	72,7	85,2
Shear	Rebar B500B	$V_{Rec}$ [kN]	-	10,5	14,8	20,0	26,2	41,0	64,3	69,5	80,5	92,4	105,2

a) With overall partial safety factor for action  $\gamma = 1,4$ . The partial safety factors for action depend on the type of loading and shall be taken from national regulations.

### Seismic loading (for a single anchor)

#### All data in this section applies to:

- Correct setting (See setting)
- No edge distance and spacing influence
- Steel failure
- Minimum base material thickness
- Concrete C 20/25
- In-service temperate range I  
(min, base material temperature  $-40^{\circ}\text{C}$ , max, long term/short term base material temperature:  $+24^{\circ}\text{C}/40^{\circ}\text{C}$ )
- $\alpha_{\text{gap}} = 1,0$

#### Embedment depth and base material thickness in case of seismic performance category C1

Anchor- size			$\phi 8$	$\phi 10$	$\phi 12$	$\phi 14$	$\phi 16$	$\phi 20$	$\phi 25$	$\phi 26$	$\phi 28$	$\phi 30$	$\phi 32$
Typical embedment depth	$h_{\text{ef}}$	[mm]	-	90	110	125	125	170	210	240	270	270	300
Base material thickness	$h$	[mm]	-	120	145	165	165	220	275	305	340	345	380

#### Characteristic resistance in case of seismic performance category C1

Anchor- size				$\phi 8$	$\phi 10$	$\phi 12$	$\phi 14$	$\phi 16$	$\phi 20$	$\phi 25$	$\phi 26$	$\phi 28$	$\phi 30$	$\phi 32$
Tensile	Rebar B500B	$N_{\text{Rk}}$	[kN]	-	12,4	25,3	33,5	38,3	64,9	89,1	108,8	129,9	129,9	152,1
Shear	Rebar B500B	$V_{\text{Rk, seis}}$	[kN]	-	15,0	22,0	29,0	39,0	60,0	95,0	102,0	118,0	136,0	155,0

#### Design resistance in case of seismic performance category C1

Anchor- size				$\phi 8$	$\phi 10$	$\phi 12$	$\phi 14$	$\phi 16$	$\phi 20$	$\phi 25$	$\phi 26$	$\phi 28$	$\phi 30$	$\phi 32$
Tensile	Rebar B500B	$N_{\text{Rd}}$	[kN]	-	8,3	16,9	22,4	25,6	43,4	59,4	72,6	86,6	86,6	101,4
Shear	Rebar B500B	$V_{\text{Rd, seis}}$	[kN]	-	10,0	14,7	19,3	26,0	40,0	63,3	68,0	78,7	90,7	103,3



## Materials

### Mechanical properties

Anchor size			φ8	φ10	φ12	φ14	φ16	φ20	φ25	φ26	φ28	φ30	φ32
Nominal tensile strength	$f_{uk}$	[N/mm <sup>2</sup> ]	550	550	550	550	550	550	550	550	550	550	550
Yield strength	$f_{yk}$	[N/mm <sup>2</sup> ]	500	500	500	500	500	500	500	550	500	550	500
Stressed cross-section	$A_s$	[mm <sup>2</sup> ]	50,3	78,5	113	154	201	314	491	531	616	707	804
Moment of resistance	$W$	[mm <sup>3</sup> ]	50,3	98,2	170	269	402	785	1534	1726	2155	2651	3217

### Material quality

Part	Material
Rebar EN 1992-1-1:2004 and AC:2010	Bars and de-coiled rods class B or C according to NDP or NCL of EN 1992-1-1/NA

## Setting information

### Installation temperature range

- 10°C to + 40°C

### Service temperature range

Hilti HIT-HY 200-R V3 injection mortar may be applied in the temperature ranges given below, An elevated base material temperature may lead to a reduction of the design bond resistance.

Temperature range	Base material temperature	Maximum long term base material temperature	Maximum short term base material temperature
Temperature range I	-40 °C to + 40 °C	+ 24 °C	+ 40 °C
Temperature range II	-40 °C to + 80 °C	+ 50 °C	+ 80 °C
Temperature range III	-40 °C to + 120 °C	+ 72 °C	+ 120 °C

### Maximum short term base material temperature

Short term elevated base material temperatures are those that occur over brief intervals, e.g, as a result of diurnal cycling.

### Maximum long term base material temperature

Long term elevated base material temperatures are roughly constant over significant periods of time.

## Curing and working time

Temperature of the base material	HIT-HY 200-RV3	
	Maximum working time	Minimum curing time
$T_{BM}$	$t_{work}$	$t_{cure}$
- 10°C < $T_{BM}$ ≤ - 5°C	3 h	20 h
- 5°C < $T_{BM}$ ≤ 0°C	1,5 h	8 h
0°C < $T_{BM}$ ≤ 5°C	45 min	4 h
5°C < $T_{BM}$ ≤ 10°C	30 min	2,5 h
10°C < $T_{BM}$ ≤ 20°C	15 min	1,5 h
20°C < $T_{BM}$ ≤ 30°C	9 min	1 h
30°C < $T_{BM}$ ≤ 40°C	6 min	1 h



**Setting details**

Anchor size		Ø8	Ø10	Ø12	Ø14	Ø16	Ø20	Ø25	Ø26	Ø28	Ø30	Ø32
Nominal diameter of drill bit	$d_0$ [mm]	10 / 12 <sup>a)</sup>	12 / 14 <sup>a)</sup>	14 / 16 <sup>a)</sup>	18	20	25	32	32	35	37	40
Effective anchorage and drill hole depth range <sup>b)</sup>	$h_{ef,min}$ [mm]	60	60	70	75	80	90	100	104	112	120	128
	$h_{ef,max}$ [mm]	160	200	240	280	320	400	500	520	560	600	640
Minimum base material thickness	$h_{min}$ [mm]	$h_{ef} + 30 \text{ mm} \geq 100 \text{ mm}$			$h_{ef} + 2 d_0$							
Minimum spacing	$s_{min}$ [mm]	40	50	60	70	80	100	125	130	140	150	160
Minimum edge distance	$c_{min}$ [mm]	40	45	45	50	50	65	70	75	75	80	80
Critical spacing for splitting failure	$s_{cr,sp}$ [mm]	$2 c_{cr,sp}$										
Critical edge distance for splitting failure <sup>c)</sup>	$c_{cr,sp}$ [mm]	$1,0 \cdot h_{ef}$		for $h / h_{ef} \geq 2,0$								
		$4,6 h_{ef} - 1,8 h$		for $2,0 > h / h_{ef} > 1,3$								
		$2,26 h_{ef}$		for $h / h_{ef} \leq 1,3$								
Critical spacing for concrete cone failure	$s_{cr,N}$ [mm]	$2 c_{cr,N}$										
Critical edge distance for concrete cone failure <sup>d)</sup>	$c_{cr,N}$ [mm]	$1,5 h_{ef}$										

For spacing (edge distance) smaller than critical spacing (critical edge distance) the design loads have to be reduced,



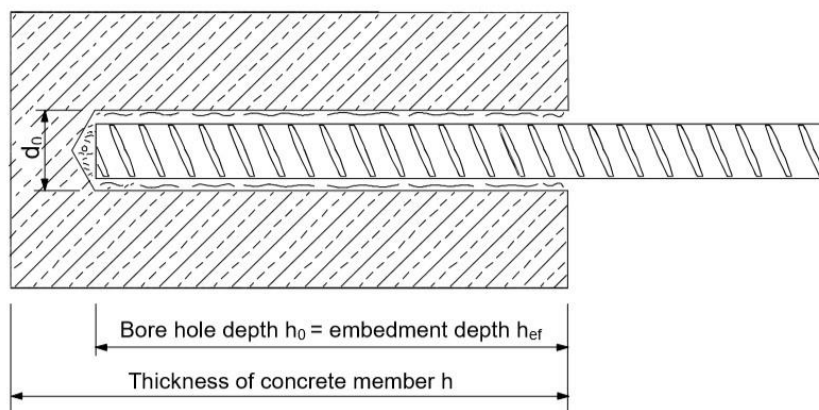
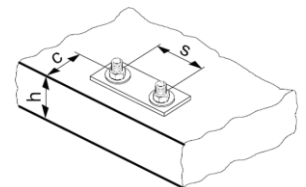

- Both given values for drill bit diameter can be used
- $h_{ef,min} \leq h_{ef} \leq h_{ef,max}$  ( $h_{ef}$ : embedment depth)
- $h$ : base material thickness ( $h \geq h_{min}$ )
- The critical edge distance for concrete cone failure depends on the embedment depth  $h_{ef}$  and the design bond resistance. The simplified formula given in this table is on the safe side.



**Installation equipment**

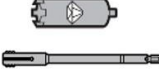

Anchor size	φ8	φ10	φ12	φ14	φ16	φ20	φ25	φ26	φ28	φ30	φ32
Rotary hammer	TE 2 (-A) – TE 16 (-A)					TE 40 – TE 80					
Other tools	blow out pump ( $h_{ef} \leq 10 \cdot d$ , $d_0 \leq 20$ mm), Compressed air gun, Set of cleaning brushes, dispenser										

**Drilling and cleaning diameters**

Rebar	Hammer drill (HD)	Hollow Drill Bit (HDB)	Diamond coring with Roughening Tool (RT) <sup>b)</sup>	Brush HIT-RB
$d_0$ [mm]				size [mm]
				
φ8	12 / 10 <sup>a)</sup>	12	-	12 / 10 <sup>a)</sup>
φ10	14 / 12 <sup>a)</sup>	14 / 12 <sup>a)</sup>	-	14 / 12 <sup>a)</sup>
φ12	16 / 14 <sup>a)</sup>	16 / 14 <sup>a)</sup>	-	16 / 14 <sup>a)</sup>
φ14	18	18	18	18
φ16	20	20	20	20
φ20	25	25	25	25
φ25	32	32	32	32
φ26	32	32	32	32
φ28	35	35	35	35
φ30	37	-	-	37
φ32	40	-	-	40

a) Both given values can be used

**Associated components for the use of Hilti Roughening tool TE-YRT**

Diamond coring		Roughening tool TE-YRT	Wear gauge RTG...
			
$d_0$ [mm]		$d_0$ [mm]	size
Nominal	measured		
18	17,9 to 18,2	18	18
20	19,9 to 20,2	20	20
22	21,9 to 22,2	22	22
25	24,9 to 25,2	25	25
28	27,9 to 28,2	28	28
30	29,9 to 30,2	30	30
32	31,9 to 32,2	32	32
35	34,9 to 35,2	35	35

**Installation parameters for use of the Hilti Roughening tool TE-YRT**

$h_{ef}$ [mm]	Minimum roughening time $t_{roughen}$ [sec] ( $t_{roughen}$ [sec] = $h_{ef}$ [mm] / 10)	Minimum blowing time $t_{blowing}$ [sec] ( $t_{blowing}$ [sec] = $t_{roughen}$ [sec] + 20)
0 to 100	10	30
101 to 200	20	40
201 to 300	30	50
301 to 400	40	60
401 to 500	50	70
501 to 600	60	80

## Setting instructions

\*For detailed information on installation see instruction for use given with the package of the product,



### Safety regulations.

Review the Material Safety Data Sheet (MSDS) before use for proper and safe handling! Wear well-fitting protective goggles and protective gloves when working with Hilti HIT-HY 200.

## Drilling

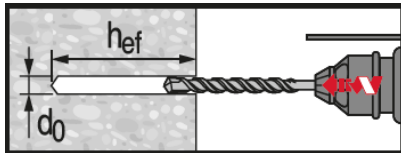

Hammer drilled hole (HD)

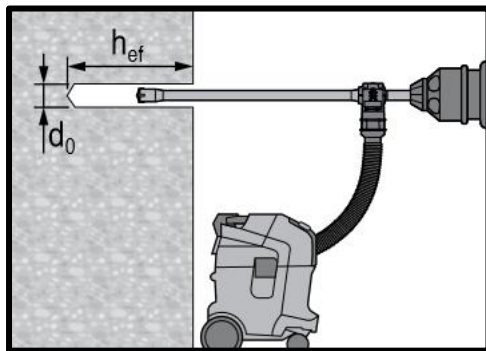

Hammer drilled hole with Hollow Drilled Bit (HDB)

No cleaning required

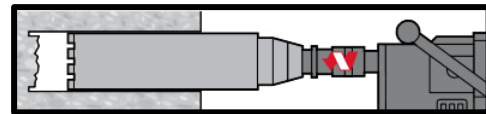

Diamond Drilling + Roughening Tool (DD+RT)

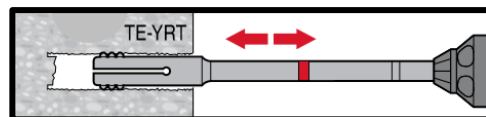

## Cleaning (Inadequate hole cleaning = poor load values.)

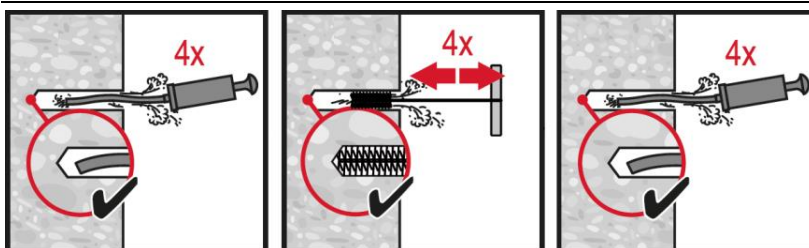

### Hammer drilling:

#### Manual cleaning (MC)

for drill diameters  $d_0 \leq 20$  mm and drill hole depth  $h_0 \leq 10 \cdot d$ .

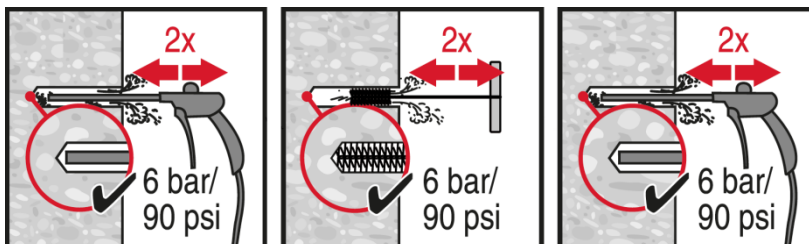

### Hammer drilling:

#### Compressed air cleaning (CAC)

for all drill hole diameters  $d_0$  and drill hole depths  $h_0 \leq 20 \cdot d$ .

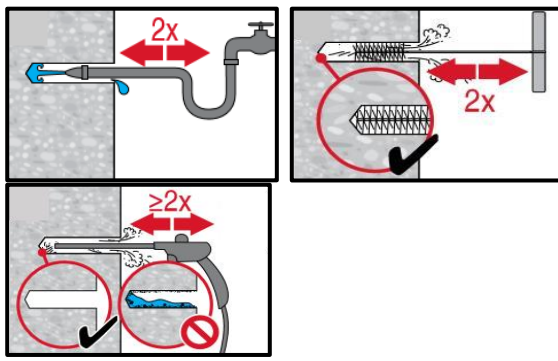

**Diamond cored holes with Hilti roughening tool:**

For all drill hole diameters  $d_0$  and drill hole depths  $h_0$ .

**Injection system preparation**

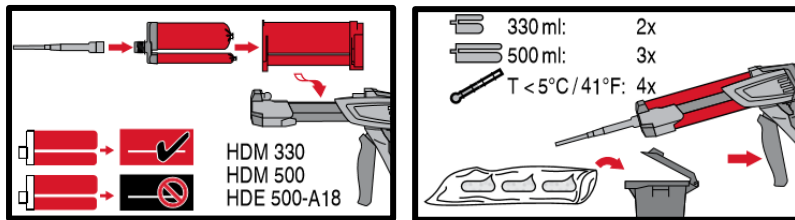

**Injection system preparation.**

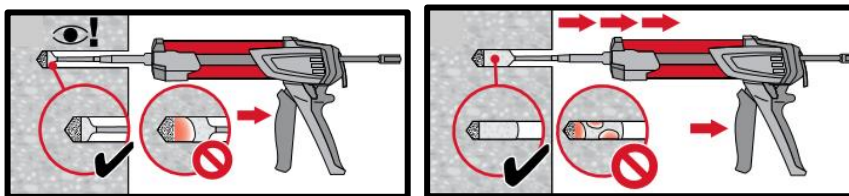

**Injection method for drill hole depth  $h_{ef} \leq 250$  mm.**

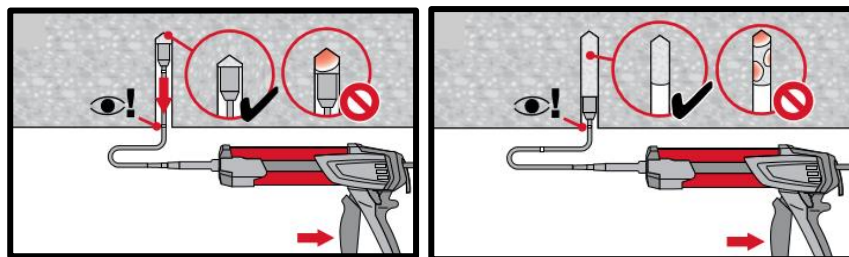

**Injection method for overhead application and/or installations with embedment depth  $h_{ef} \geq 250$  mm.**

**Setting the element**

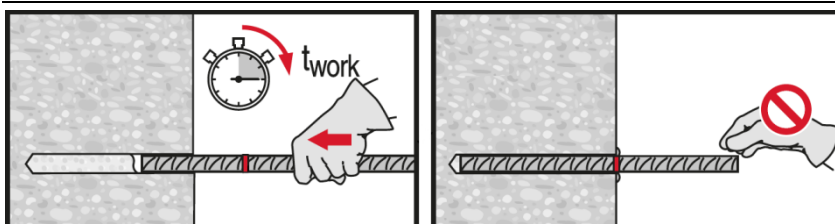

**Setting element, observe working time "t<sub>work</sub>".**

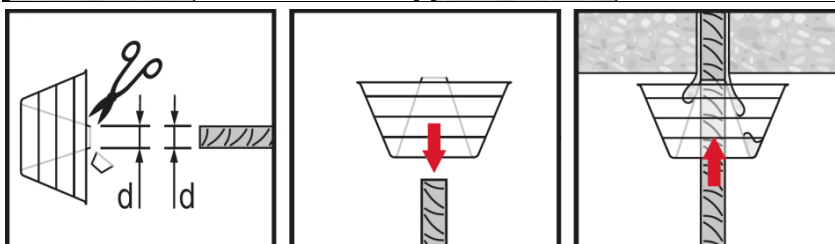

**Setting element for overhead applications, observe working time "t<sub>work</sub>".**

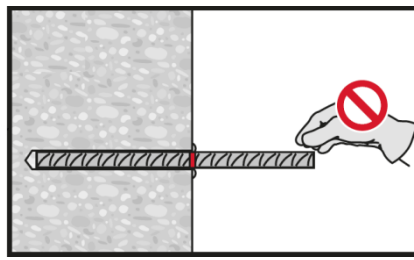
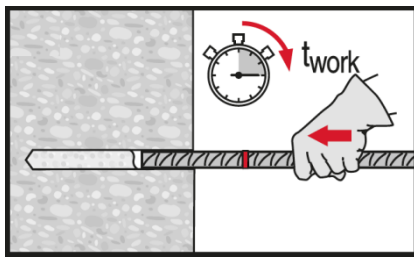

**Setting element, observe working time**  
“t<sub>work</sub>”.

# HIT-HY 200-R V3 injection mortar

Rebar design (EN 1992-1-1, EOTA TR 069) / Rebar elements / Concrete

## Injection mortar system



Hilti HIT-HY 200-R V3

330 ml foil pack  
(also available as 500 ml foil pack)



Rebar  
( $\phi 8$  -  $\phi 40$ )

## Benefits

- **SafeSet** technology: Simplified method of borehole preparation using either Hilti hollow drill bit for hammer drilling or Roughening tool for diamond cored applications
- HY 200-R V3 version is formulated for best handling and cure time specifically for rebar applications
- Suitable for concrete C 12/15 to C 50/60
- Suitable for dry and water saturated concrete
- For rebar diameters up to 40 mm for static design acc. to EN 1992-1-1
- Non corrosive to rebar elements
- Good load capacity at elevated temperatures
- Suitable for embedment length up to 1000 mm
- Suitable for applications down to -10 °C

## Base material



Concrete (non-cracked)



Concrete (cracked)

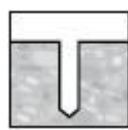

Dry concrete

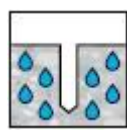

Wet concrete

## Load conditions



Static/  
quasi-static



Seismic



Fire resistance

## Installation conditions

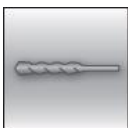

Hammer drilling



Diamond drilled holes<sup>c)</sup>



Hilti SafeSet technology

## Other informations



European Technical Assessment



CE conformity



PROFIS Engineering design Software

a) Diamond drilling only with Roughening Tool (RT)

## Approvals / certificates

Description	Authority / Laboratory	No. / date of issue
European technical Assessment <sup>a)</sup>	DIBt, Berlin	ETA-19/0600 / 2022-06-01
European technical Assessment <sup>b)</sup>	DIBt, Berlin	ETA-19/0665 / 2020-11-16

a) All data given in this section according to ETA-19/0600, issue 2022-06-01.

b) All data given in this section according to ETA-19/0665, issue 2020-11-16.

## Static and quasi-static loading

### Static design acc. to EN 1992-1-1

Design bond strength in  $\text{N/mm}^2$  for good bond conditions

All allowed drilling methods									
Rebar - size	Concrete class								
	C12/15	C16/20	C20/25	C25/30	C30/37	C35/45	C40/50	C45/55	C50/60
$\phi 8 - \phi 32$	1,6	2,0	2,3	2,7	3,0	3,4	3,7	4,0	4,3
$\phi 34$	1,6	2,0	2,3	2,7	2,9	3,3	3,6	3,9	4,2
$\phi 36$	1,6	1,9	2,2	2,6	2,9	3,3	3,6	3,8	3,8
$\phi 40$	1,5	1,8	2,1	2,5	2,8	3,1	3,4	3,4	3,4

For poor bond conditions multiply the values by 0,7. Values valid for uncracked and cracked concrete.

### Minimum anchorage length and minimum lap length

The minimum anchorage length  $\ell_{b,\min}$  and the minimum lap length  $\ell_{0,\min}$  according to EN 1992-1-1 shall be multiplied by relevant **Amplification factor  $\alpha_{lb}$**  in the table below.

#### Amplification factor $\alpha_{lb}$ for the min. anchorage length and min. lap length for

All allowed hammer drilling methods									
Rebar - size	Concrete class								
	C12/15	C16/20	C20/25	C25/30	C30/37	C35/45	C40/50	C45/55	C50/60
$\phi 8 - \phi 40$	1,0								



**Anchorage length for characteristic steel strength  $f_{yk}=500 \text{ N/mm}^2$  for good conditions**

All allowed drilling methods								
Rebar-size	Concrete class	Yielding load [kN]	$l_{b,min}^{1)}$ [mm]	$l_{0,min}^{1)}$ [mm]	$l_{bd,y} (\alpha_2=1)^{2)}$ [mm]	$l_{bd,y} (\alpha_2=0.7)^{3)}$ [mm]	$l_{max}^{-10^\circ\text{C} \leq C_t^{4)} \leq 0^\circ\text{C}}$ [mm]	$l_{max}^{C_t^{4)} > 0^\circ\text{C}}$ [mm]
φ8	C20/25	21,9	113	200	378	265	700	1000
φ8	C50/60	21,9	100	200	202	142	700	1000
φ10	C20/25	34,1	142	200	473	331	700	1000
φ10	C50/60	34,1	100	200	253	177	700	1000
φ12	C20/25	49,2	170	200	567	397	700	1000
φ12	C50/60	49,2	120	200	303	212	700	1000
φ14	C20/25	66,9	198	210	662	463	700	1000
φ14	C50/60	66,9	140	210	354	248	700	1000
φ16	C20/25	87,4	227	240	756	529	700	1000
φ16	C50/60	87,4	160	240	404	283	700	1000
φ18	C20/25	110,6	255	270	851	595	700	1000
φ18	C50/60	110,6	180	270	455	319	700	1000
φ20	C20/25	136,6	284	300	945	662	700	1000
φ20	C50/60	136,6	200	300	506	354	700	1000
φ22	C20/25	165,3	312	330	1040	728	700	1000
φ22	C50/60	165,3	220	330	556	389	700	1000
φ24	C20/25	196,7	340	360	1134	794	700	1000
φ24	C50/60	196,7	240	360	607	425	700	1000
φ25	C20/25	213,4	354	375	1181	827	700	1000
φ25	C50/60	213,4	250	375	632	442	700	1000
φ26	C20/25	230,8	369	390	1229	860	700	1000
φ26	C50/60	230,8	260	390	657	460	700	1000
φ28	C20/25	267,7	397	420	1323	926	700	1000
φ28	C50/60	267,7	280	420	708	495	700	1000
φ30	C20/25	307,3	425	450	1418	992	700	1000
φ30	C50/60	307,3	300	450	758	531	700	1000
φ32	C20/25	349,7	454	480	1512	1059	700	1000
φ32	C50/60	349,7	320	480	809	566	700	1000
φ34	C20/25	394,7	482	510	1607	1125	700	1300
φ34	C50/60	394,7	340	510	880	616	700	1300
φ36	C20/25	442,6	534	540	1779	1245	700	1300
φ36	C50/60	442,6	360	540	1030	721	700	1300
φ40	C20/25	546,4	621	621	2070	1449	700	1300
φ40	C50/60	546,4	400	600	1279	895	700	1300

1) According to EC2: EN 1992-1-1:2004  $l_{b,min}$  (8.6) and  $l_{0,min}$  (8.11) are calculated for good bond conditions with characteristic yield strength  $f_{yk} = 500 \text{ N/mm}^2$ ,  $\gamma_M=1,15$  and  $\alpha_6 = 1,0$

2) Embedment depth for yield of the rebar and for  $c_d/\phi = 1$  (characteristic yield strength  $f_{yk} = 500 \text{ N/mm}^2$ )

3) Embedment depth for yield of the rebar and for  $c_d/\phi = 3$  (characteristic yield strength  $f_{yk} = 500 \text{ N/mm}^2$ )

4)  $c_t$ =concrete temperature



## Static design acc. to EOTA TR 069

### Essential characteristics for rebar under tension load in concrete – 50 and 100 years working time

Rebar			φ8	φ10	φ12	φ14	φ16	φ20	φ25	φ26	φ28	φ30	φ32	
Diameter of rebar	φ	[mm]	8	10	12	14	16	20	25	26	28	30	32	
<b>Pull-out resistance</b>														
<b>Characteristic bond resistance in uncracked concrete C20/25 – 50 years working life</b>														
Temperature range I: 40°C/24°C	$T_{Rk,ucr,50}$	[N/mm <sup>2</sup> ]	12											
Temperature range II: 80°C/50°C	$T_{Rk,ucr,50}$	[N/mm <sup>2</sup> ]	10											
Temperature range II: 80°C/50°C	$T_{Rk,ucr,50}$	[N/mm <sup>2</sup> ]	8,5											
<b>Characteristic bond resistance in uncracked concrete C20/25 – 100 years working life</b>														
Temperature range I: 40°C/24°C	$T_{Rk,ucr,100}$	[N/mm <sup>2</sup> ]	11											
Temperature range II: 80°C/50°C	$T_{Rk,ucr,100}$	[N/mm <sup>2</sup> ]	9,5											
Temperature range II: 80°C/50°C	$T_{Rk,ucr,100}$	[N/mm <sup>2</sup> ]	8											
Influence of cracked concrete	$\Omega_{cr}$	[-]	0,53	0,58			0,61		0,64			0,73		
<b>Installation safety factor</b>														
Hammer drilling	$\gamma_{inst}$	[-]	1,0											
Hammer drilling with Hilti hollow drill bit TE-CD or TE-YD	$\gamma_{inst}$	[-]	1,0							-				
Diamond coring with roughening with Hilti roughening tool TE-YRT	$\gamma_{inst}$	[-]	-			1,0					-			
<b>Bond-splitting resistance</b>														
Product basic factor	$A_k$	[-]	4,1											
Exponent for influence of concrete compressive strength	$sp_1$	[-]	0,31											
Exponent for influence of rebar diameter φ	$sp_2$	[-]	0,32											
Exponent for influence of concrete cover $c_d$	$sp_3$	[-]	0,67											
Exponent for influence of side concrete cover ( $c_{max} / c_d$ )	$sp_4$	[-]	0,25											
Exponent for influence of anchorage length $l_b$	$lb_1$	[-]	0,45											
<b>Influence factors <math>\Psi</math> on bond resistance <math>T_{Rk}</math></b>														
Cracked and uncracked concrete: Factor for concrete strength	$\Psi_c$	C30/37	1,04											
		C40/45	1,07											
		C50/60	1,10											
Cracked and uncracked concrete: Sustained load factor – 50 years	$\Psi^0_{sus,50}$	40°C/24°C	0,74											
		80°C/50°C	0,89											
		120°C/72°C	0,72											
Cracked and uncracked concrete: Sustained load factor – 100 years	$\Psi^0_{sus,100}$	40°C/24°C	No Performance Assessed											
		80°C/50°C	No Performance Assessed											
		120°C/72°C	No Performance Assessed											

Concrete cone failure			
Factor for uncracked concrete	$k_{ucr,N}$	[-]	11,0
Factor for cracked concrete	$k_{cr,N}$	[-]	7,7
Edge distance	$c_{cr,N}$	[mm]	$1,5 \cdot l_b$
Spacing	$s_{cr,N}$	[mm]	$3,0 \cdot l_b$

### Seismic data

#### Seismic reduction factor $k_{b,seis}$ for hammer drilling (HD) and (HDB) and compressed air drilling (CA)

Rebar - size	Reduction factor $k_{b,seis}$							
	Concrete class							
	C16/20	C20/25	C25/30	C30/37	C35/45	C40/50	C45/55	C50/60
$\phi 10 - \phi 18$	1,0				0,90	0,82	0,76	0,71
$\phi 20 - \phi 30$	1,0						0,92	0,86
$\phi 32$	1,0							

For poor bond conditions multiply the values 0,7.

#### Design values for the ultimate bond resistance $f_{bd,seis}$ <sup>1)</sup> in N/mm<sup>2</sup> for seismic loading for hammer drilling (HD) and (HDB) and compressed air drilling (CA)

Rebar - size	Bond resistance $f_{bd,seis}$							
	Concrete class							
	C16/20	C20/25	C25/30	C30/37	C35/45	C40/50	C45/55	C50/60
$\phi 10 - \phi 18$	2,0	2,3	2,7	3,0				
$\phi 20 - \phi 30$	2,0	2,3	2,7	3,0	3,4	3,7		
$\phi 32$	2,0	2,3	2,7	3,0	3,4	3,7	4,0	4,3

<sup>1)</sup> According to EN 1992-1-1:2004 for good bond conditions. For all other bond conditions multiply the values by 0.7.

### Materials

#### Material quality

Part	Material
Rebar EN 1992-1-1	Bars and de-coiled rods class B or C with $f_{yk}$ and $k$ according to NDP or NCL of EN 1992-1-1 $f_{uk} = f_{tk} = k \cdot f_{yk}$

#### Fitness for use

Some creep tests have been conducted in accordance with ETAG guideline 001 part 5 and TR 023 in the following conditions: **in dry environment at 50 °C during 90 days.**

These tests show an excellent behaviour of the post-installed connection made with HIT-HY 200: low displacements with long term stability, failure load after exposure above reference load.

#### Resistance to chemical substances

Chemical	Resistance	Chemical	Resistance
Air	+	Gasoline	+
Acetic acid 10%	+	Glycole	o
Acetone	o	Hydrogen peroxide 10%	o
Ammonia 5%	+	Lactic acid 10%	+
Benzyl alcohol	-	Machinery oil	+
Chloric acid 10%	o	Methylethylketon	o
Chlorinated lime 10%	+	Nitric acid 10%	o
Citric acid 10%	+	Phosphoric acid 10%	+
Concrete plasticizer	+	Potassium Hydroxide pH 13,2	+
De-icing salt (Calcium chloride)	+	Sea water	+

Demineralized water	+
Diesel fuel	+
Drilling dust suspension pH 13,2	+
Ethanol 96%	-
Ethylacetate	-
Formic acid 10%	+
Formwork oil	+

Sewage sludge	+
Sodium carbonate 10%	+
Sodium hypochlorite 2%	+
Sulfuric acid 10%	+
Sulfuric acid 30%	+
Toluene	o
Xylene	o

- + resistant  
 o resistant in short term (max. 48h) contact  
 - not resistant

### Electrical Conductivity

HIT-HY 200 in the hardened state **is not conductive electrically**. Its electric resistivity is  $15,5 \cdot 10^9 \Omega \cdot \text{cm}$  (DIN IEC 93 – 12.93). It is adapted well to realize electrically insulating anchoring (ex: railway applications, subway)

### Setting information

#### Installation temperature range

-10°C to +40°C

#### Service temperature range

Hilti HIT-HY 200 injection mortar may be applied in the temperature ranges given below. An elevated base material temperature may lead to a reduction of the design bond resistance.

Temperature range	Base material temperature	Maximum long term base material temperature	Maximum short term base material temperature
Temperature range I	-40 °C to +80 °C	+50 °C	+80 °C

#### Maximum short term base material temperature

Short-term elevated base material temperatures are those that occur over brief intervals, e.g. as a result of diurnal cycling.

#### Maximum long term base material temperature

Long-term elevated base material temperatures are roughly constant over significant periods of time.

### Curing and working time

Temperature of the base material	HIT-HY 200-R V3	
	Maximum working time	Minimum curing time
$T_{BM}$	$t_{work}$	$t_{cure}$
$-10^{\circ}\text{C} < T_{BM} \leq -5^{\circ}\text{C}$	3 h	20 h
$-4^{\circ}\text{C} < T_{BM} \leq 0^{\circ}\text{C}$	1,5 h	8 h
$1^{\circ}\text{C} < T_{BM} \leq 5^{\circ}\text{C}$	45 min	4 h
$6^{\circ}\text{C} < T_{BM} \leq 10^{\circ}\text{C}$	30 min	2,5 h
$11^{\circ}\text{C} < T_{BM} \leq 20^{\circ}\text{C}$	15 min	1,5 h
$21^{\circ}\text{C} < T_{BM} \leq 30^{\circ}\text{C}$	9 min	1 h
$31^{\circ}\text{C} < T_{BM} \leq 40^{\circ}\text{C}$	6 min	1 h

### Setting information

#### Installation equipment

Rebar – size	$\phi 8 - \phi 16$	$\phi 18 - \phi 40$
Rotary hammer	TE 2 (-A)– TE 40(-A)	TE40 – TE80
Other tools	Blow out pump ( $h_{ef} \leq 10 \cdot d$ )	-
	Compressed air gun <sup>a)</sup> Set of cleaning brushes <sup>b)</sup> , dispenser, piston plug Roughening tools	





<sup>a)</sup> Compressed air gun with extension hose for all drill holes deeper than 250 mm (for  $\phi 8$  to  $\phi 12$ ) or deeper than  $20 \cdot \phi$  (for  $\phi > 12$  mm).

<sup>b)</sup> Automatic brushing with round brush for all drill holes deeper than 250 mm (for  $\phi 8$  to  $\phi 12$ ) or deeper than  $20 \cdot \phi$  (for  $\phi > 12$  mm)

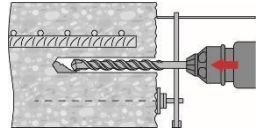
**Minimum concrete cover  $c_{min}$  of the post-installed rebar**

Drilling method	Bar diameter [mm]	Minimum concrete cover $c_{min}$ [mm]	
		Without drilling aid	With drilling aid
Hammer drilling (HD) and (HDB)	$\phi < 25$	$30 + 0,06 \cdot l_v \geq 2 \cdot \phi$	$30 + 0,02 \cdot l_v \geq 2 \cdot \phi$
	$\phi \geq 25$	$40 + 0,06 \cdot l_v \geq 2 \cdot \phi$	$40 + 0,02 \cdot l_v \geq 2 \cdot \phi$
Compressed air drilling (CA)	$\phi < 25$	$50 + 0,08 \cdot l_v$	$50 + 0,02 \cdot l_v$
	$\phi \geq 25$	$60 + 0,08 \cdot l_v \geq 2 \cdot \phi$	$60 + 0,02 \cdot l_v \geq 2 \cdot \phi$
Diamond coring with roughening with Hilti Roughening tool TE-YRT (RT)	$\phi < 25$	$30 + 0,06 \cdot l_v \geq 2 \cdot \phi$	$30 + 0,02 \cdot l_v \geq 2 \cdot \phi$
	$\phi \geq 25$	$40 + 0,06 \cdot l_v \geq 2 \cdot \phi$	$40 + 0,02 \cdot l_v \geq 2 \cdot \phi$

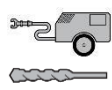
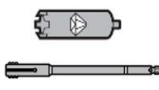



**Drilling and cleaning diameters**

Rebar [mm]	Drilling				Cleaning	
	Hammer drill (HD)	Hollow Drill Bit (HDB) <sup>b)</sup>	Compressed air drill (CA)	Diamond coring with roughening tool (RT) <sup>b)</sup>	Brush HIT-RB	Air nozzle HIT-RB
	$d_0$ [mm]				size [mm]	
						
$\phi 8$	12 / 10 <sup>a)</sup>	12	-	-	12 / 10 <sup>a)</sup>	12 / 10 <sup>a)</sup>
$\phi 10$	14 / 12 <sup>a)</sup>	14 / 12 <sup>a)</sup>	-	-	14 / 12 <sup>a)</sup>	14 / 12 <sup>a)</sup>
$\phi 12$	16 / 14 <sup>a)</sup>	16 / 14 <sup>a)</sup>	-	-	16 / 14 <sup>a)</sup>	16 / 14 <sup>a)</sup>
	-	-	17	-	18	16
$\phi 14$	18	18	17	18	18	18
$\phi 16$	20	20	-	-	20	20
	-	-	20	20	22	20
$\phi 18$	22	22	22	22	22	22
$\phi 20$	25	25	-	-	25	25
	-	-	26	25	28	25
$\phi 22$	28	28	28	28	28	28
$\phi 24$	32	32	32	32	32	32
$\phi 25$	32	32	32	32	32	
$\phi 26$	35	-	35	35	35	
$\phi 28$	35	-	35	35	35	
$\phi 30$	-	-	35	-	35	
	37	-	-	-	37	
$\phi 32$	40	-	40	-	40	
$\phi 34^{b)}$	-	-	42	-	42	
	45	-	-	-	45	32
$\phi 36^{b)}$	45	-	45	-	45	32
$\phi 40^{b)}$	55	-	-	-	55	32
	-	-	57	-	57	32

 a) Both given values can be used / Maximum installation length  $l=250$  mm.

b) Only for EN 1992-1-1 design, not available for TR 069 design.

**Associated components for the use of Hilti Roughening tool TE-YRT**

Diamond coring		Roughening tool TE-YRT	Wear gauge RTG...
			
$d_0$ [mm]		$d_0$ [mm]	size
Nominal	measured		
18	17,9 to 18,2	18	18
20	19,9 to 20,2	20	20
22	21,9 to 22,2	22	22

25	24,9 to 25,2	25	25
28	27,9 to 28,2	28	28
30	29,9 to 30,2	30	30
32	31,9 to 32,2	32	32
35	34,9 to 35,2	35	35

**Installation parameters for use of the Hilti Roughening tool TE-YRT**

$h_{ef}$ [mm]	Minimum roughening time $t_{roughen}$ [sec] ( $t_{roughen}$ [sec] = $h_{ef}$ [mm] / 10)	Minimum blowing time $t_{blowing}$ [sec] ( $t_{blowing}$ [sec] = $t_{roughen}$ [sec] + 20)
0 to 100	10	30
101 to 200	20	40
201 to 300	30	50
301 to 400	40	60
401 to 500	50	70
501 to 600	60	80

**Dispensers and corresponding maximum embedment depth  $l_{v,max}$** 

Rebar	Dispenser	
	HDM 330, HDM 500	HDE 500
	Concrete temp. $\geq -10^{\circ}\text{C}$	Concrete temp. $\geq 0^{\circ}\text{C}$
	$l_{v,max}$ [mm]	$l_{v,max}$ [mm]
$\phi 8 - \phi 32$	700	1000
$\phi 34 - \phi 40$	-	1300

**Setting instructions**

**\*For detailed information on installation see instruction for use given with the package of the product.**

**Safety regulations.**

Review the Material Safety Data Sheet (MSDS) before use for proper and safe handling! Wear well-fitting protective goggles and protective gloves when working with Hilti HIT-HY 200-R V3.

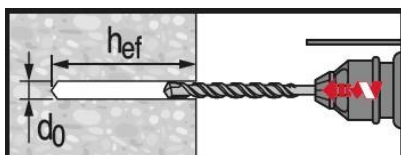
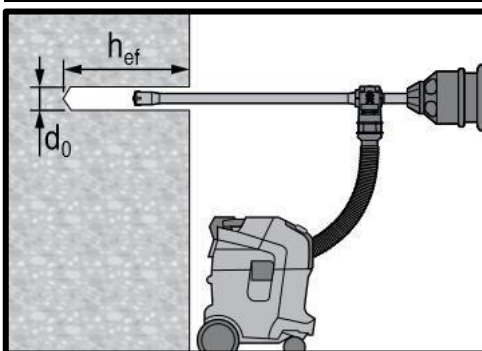
**Drilling**

**Hammer drilled hole (HD)**

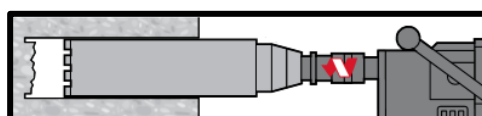
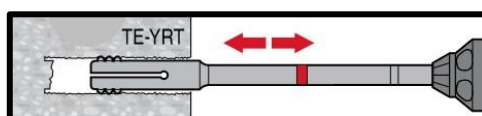
**Hammer drilled hole with Hollow Drilled Bit (HDB)**

No cleaning required

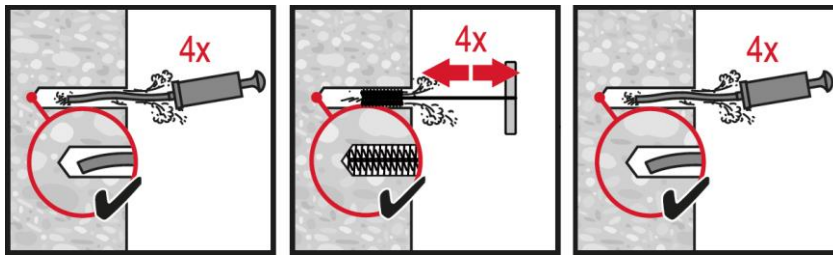
**Diamond Drilling + Roughening Tool (DD+RT)**

**Cleaning**



**Hammer drilling:**  
**Manual cleaning (MC)**  
 for drill diameters  $d_0 \leq 20$  mm and  
 drill hole depth  $h_0 \leq 10 \cdot d$ .

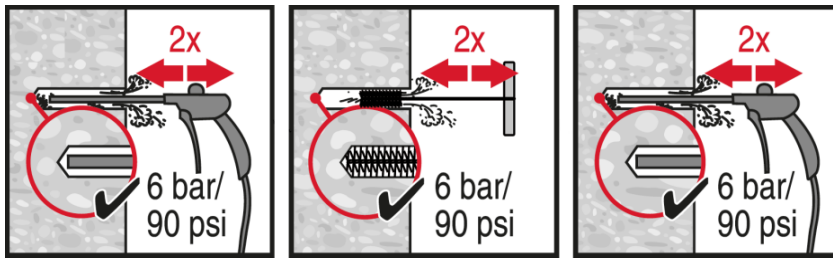

**Hammer drilling:**  
**Compressed air cleaning (CAC)**  
 for all drill hole diameters  $d_0$  and drill  
 hole depths  $h_0 \leq 20 \cdot d$ .

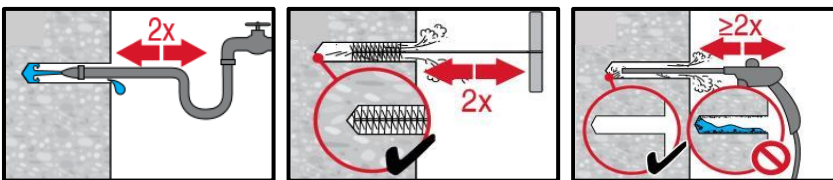

**Diamond cored holes with Hilti  
 roughening tool:**  
 For all drill hole diameters  $d_0$  and  
 drill hole depths  $h_0$ .

**Injection system preparation**

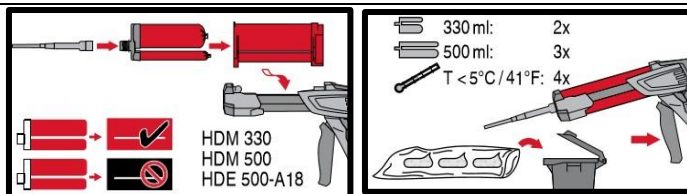

**Injection system preparation.**

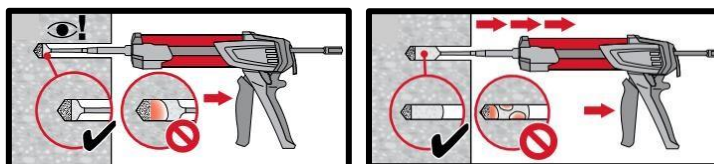

**Injection method for drill hole depth**  
 $h_{ef} \leq 250$  mm.

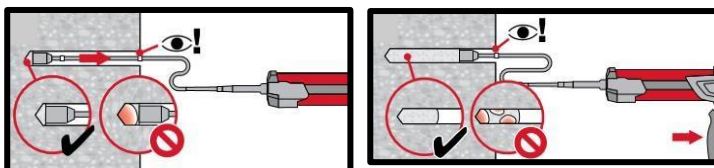

**Injection method for drill hole depth**  
 $h_{ef} > 250$  mm.

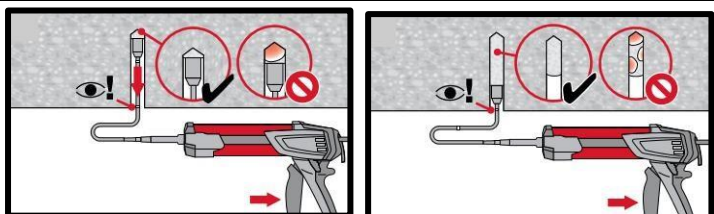

**Injection method for overhead  
 application.**

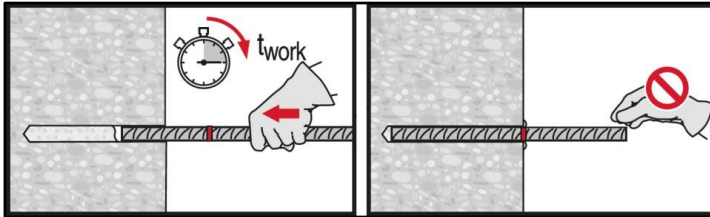
**Setting the element**

**Setting element**, observe working time  
“ $t_{work}$ ”.

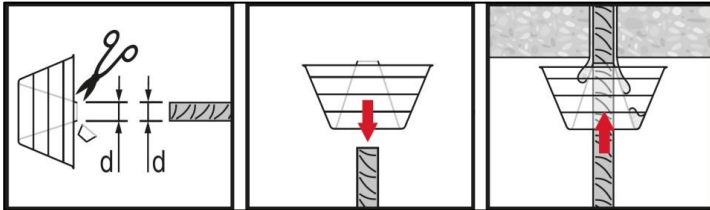

**Setting element** for overhead applications, observe working time  
“ $t_{work}$ ”.

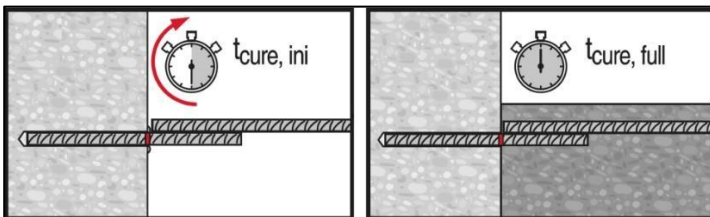
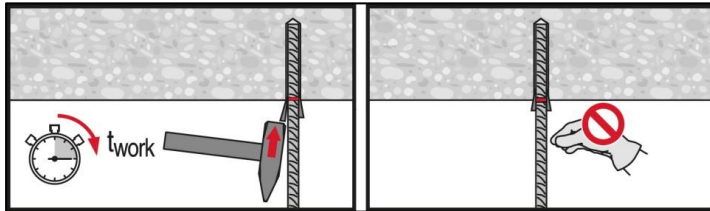

Apply full load only after curing time  
“ $t_{cure}$ ”.





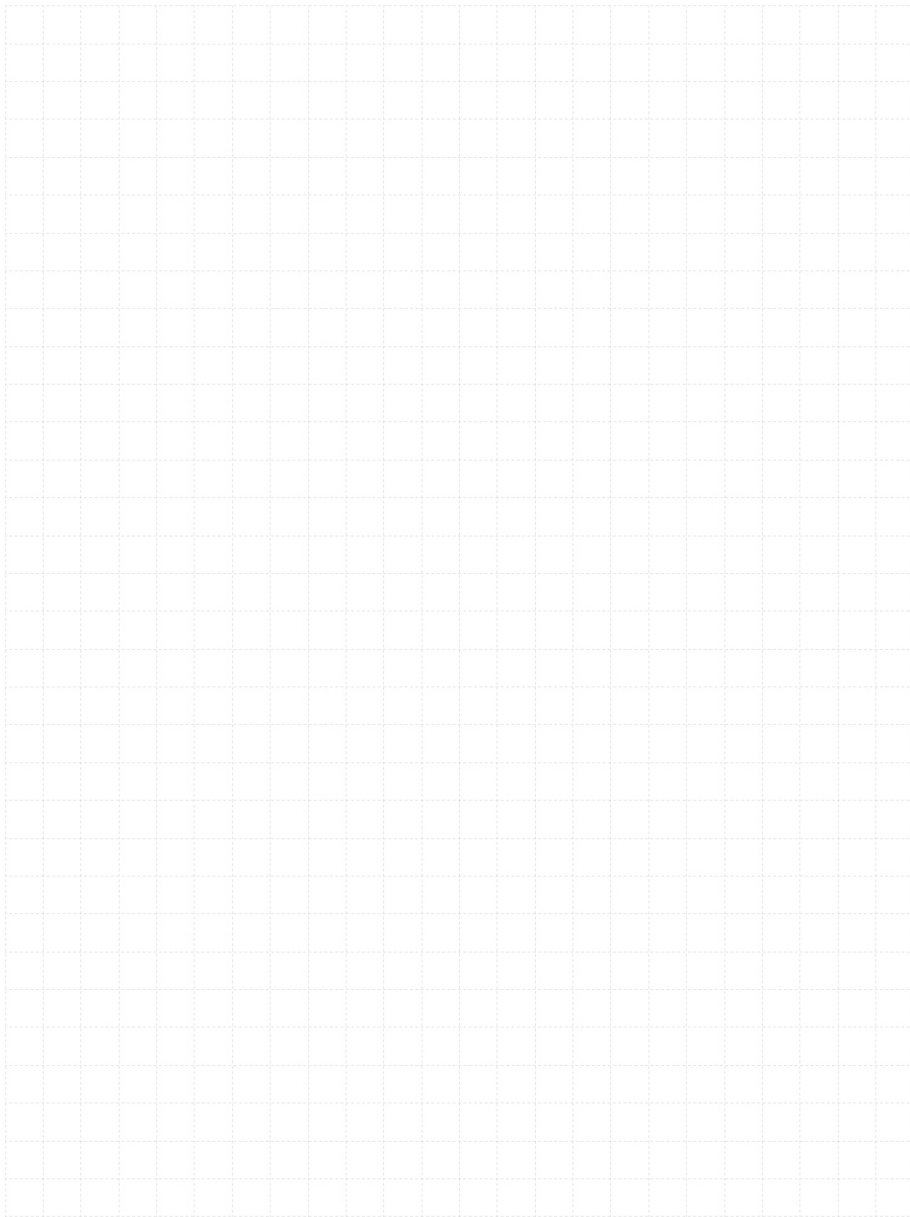



## 2.1.2 HIT-HY 200 A/R



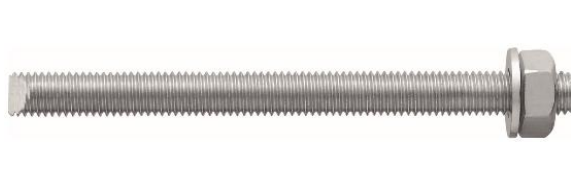









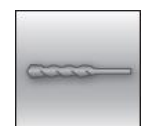

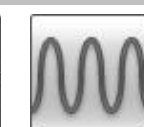

# HIT-HY 200 injection mortar

## Anchor design (EN 1992-4) / Rods and Sleeves / Concrete

Injection mortar system		Benefits
	Hilti HIT- HY 200-A  500 ml foil pack (also available as 330 ml foil pack)	<ul style="list-style-type: none"> <li>- <b>SafeSet</b> technology: Simplified method of borehole preparation using either Hilti hollow drill bit for hammer drilling or Roughening tool for diamond cored applications</li> </ul>
	Hilti HIT- HY 200-R, HIT- HY 200-R V3  500 ml foil pack (also available as 330 ml foil pack)	<ul style="list-style-type: none"> <li>- Suitable for non-cracked and cracked concrete C 20/25 to C 50/60</li> <li>- ETA Approved for seismic performance category C1, C2<sup>a)</sup></li> </ul>
	Anchor rod: HAS-U HAS-U HDG HAS-U A4 HAS-U HCR (M8-M30)	<ul style="list-style-type: none"> <li>- Maximum load performance in cracked concrete and non-cracked concrete</li> <li>- 100 years service lifetime resistance<sup>b)</sup></li> </ul>
	Internally threaded sleeve: HIS-N HIS-RN (M8-M20)	<ul style="list-style-type: none"> <li>- Small edge distance and anchor spacing possible</li> <li>- Manual cleaning for borehole diameter up to 20mm and <math>h_{ef} \leq 10d</math> for non-cracked concrete only</li> </ul>
	Anchor rod: HIT-Z HIT-Z-F HIT-Z-R (M8-M20)	<ul style="list-style-type: none"> <li>- Three mortar versions: HY-200-R and HY-200-R V3 for slow cure applications and HY 200-A for fast cure applications</li> </ul>
	Anchor rod: HAS-D (M12-M20)	

- a) HIS-N internally threaded sleeves not approved for Seismic.  
 b) Only HIT-Z anchor rod has this feature.

Base material			Installation conditions					
								
Concrete (uncracked)	Concrete (cracked)	100 Years Design Life	Hammer drilled holes	Diamond drilled holes <sup>c)</sup>	Hilti <b>SafeSet</b> technology	Variable embedment depth	Small edge distance and spacing	
Load conditions			Other information					
								
Static/ quasi-static	Seismic, ETA-C1, C2 <sup>a)</sup>	Fatigue ETA <sup>d)</sup>	Fire resistance	European Technical Assessment	CE conformity	Corrosion resistance <sup>b)</sup>	High corrosion resistance <sup>b)</sup>	PROFIS Engineering Design Software

- a) HIS-N internally threaded sleeves not approved for Seismic category C2.  
 b) High Corrosion resistant rods available only for HAS-U. Corrosion resistant rods available for HAS-U and HIS-N.  
 c) Diamond drilling covered for HIT-Z rods. Diamond drilling only with Roughening Tool (RT) for HAS-U and HIS-N.  
 d) Only for HAS-D rods.

**Approvals / certificates**

Description	Product	Authority / Laboratory	No. / date of issue
European Technical Assessment <sup>a)</sup>	HY 200-A (Anchor)	DIBt, Berlin	ETA-11/0493 / 2022-10-12
European Technical Assessment <sup>a)</sup>	HY 200-A (HIT-Z)	DIBt, Berlin	ETA-12/0006 / 2020-10-28
European Technical Assessment <sup>a)</sup>	HY 200-R (Anchor)	DIBt, Berlin	ETA-12/0084 / 2022-10-12
European Technical Assessment <sup>a)</sup>	HY 200-R V3 (HIT-Z)	DIBt, Berlin	ETA-19/0632 / 2020-10-28
European Technical Assessment <sup>a)</sup>	HY 200-R (HIT-Z)	DIBt, Berlin	ETA-12/0028 / 2020-10-28
European Technical Assessment <sup>a)</sup>	HY 200-A/R/R V3 (HAS-D)	DIBt, Berlin	ETA-18/0972 / 2020-05-13
European Technical Assessment <sup>a)</sup>	HY 200-A/R/R V3 (HAS-D)	DIBt, Berlin	ETA-18/0978 / 2020-05-13
European Technical Assessment <sup>a)</sup>	HY 200-A (HIT-Z-D)	DIBt, Berlin	ETA-15/0296 / 2020-05-13
European Technical Assessment <sup>a)</sup>	HY 200-A (HIT-Z-D)	DIBt, Berlin	ETA-15/0802 / 2020-04-15
Shockproof fastenings in civil defence installations	HY 200-A/R	Federal Office for Civil Protection, Bern	BZS D 13-604 / 2013-12-31 BZS D 13-603 / 2013-12-31
Fire test report	HY 200-A/R	IBMB, Brunswick	3502/676/12 / 2017-09-15

a) All data given in this section according to the ETA approval for the product.

**Static and quasi-static resistance (for a single anchor)**
**All data in this section applies to:**

- Correct setting (See setting instruction)
  - No edge distance and spacing influence
  - Steel failure
  - Minimum base material thickness
  - Embedment depth, as specified in the table
  - Anchor material, as specified in the tables
  - Concrete C 20/25
  - in-service temperature range I  
(min. base material temp. -40°C, max. long/short term base material temp.: +24°C/40°C)
  - Short term loading. For long term loading please apply  $\psi_{\text{sus}} = 0.74^{\text{b)}$
- b) HIT-Z and HAS-D are suitable for permanent loading without any load reduction.  $\psi_{\text{sus}}$  is not considered for this element.

**For hammer drilled holes, hammer drilled holes with Hilti hollow drill bit:**
**Embedment depth <sup>1)</sup> and base material thickness**

Anchor size		M8	M10	M12	M16	M20	M24	M27	M30
<b>HAS-U</b>									
Embedment depth	$h_{\text{ef}}$ [mm]	80	90	110	125	170	210	240	270
Base material thickness	$h$ [mm]	110	120	140	160	220	270	300	340
<b>HIS-N</b>									
Embedment depth	$h_{\text{ef}}$ [mm]	90	110	125	170	205	-	-	-
Base material thickness	$h$ [mm]	120	150	170	230	270	-	-	-
<b>HIT-Z</b>									
Embedment depth	$h_{\text{ef}}$ [mm]	70	90	110	145	180	-	-	-
Base material thickness	$h$ [mm]	130	150	170	245	280	-	-	-
<b>HAS-D</b>									
Embedment depth	$h_{\text{ef}}$ [mm]	-	-	100	125	170	-	-	-
Base material thickness	$h$ [mm]	-	-	130	160	220	-	-	-

1) The allowed range of embedment depth is shown in the setting details.

**Characteristic resistance**

Anchor size		M8	M10	M12	M16	M20	M24	M27	M30
<b>Uncracked concrete</b>									
Tension	HAS-U 5.8	18,3	29,0	42,2	68,7	109,0	149,7	182,9	218,2
	HAS-U 8.8	29,3	42,0	56,8	68,7	109,0	149,7	182,9	218,2
	HAS-U A4	25,6	40,6	56,8	68,7	109,0	149,7	182,9	218,2
	HAS-U HCR	29,3	42,0	56,8	68,7	109,0	149,7	182,9	218,2
	HIS-N 8.8	25,0	46,0	67,0	109,0	116	-	-	-
	HIT-Z <sup>a)</sup>	24,0	38,0	50,0	85,9	118,8	-	-	-
	HAS-D	-	-	49,2	68,8	109,0	-	-	-
Shear	HAS-U 5.8	11,0	17,4	25,3	47,1	73,5	105,9	137,7	168,3
	HAS-U 8.8	14,6	23,2	33,7	62,8	98,0	141,2	183,6	224,4
	HAS-U A4	12,8	20,3	29,5	55,0	85,8	123,6	114,8	140,3
	HAS-U HCR	14,6	23,2	33,7	62,8	98,0	123,6	160,7	196,4
	HIS-N 8.8	13,0	23,0	34,0	63,0	58,0	-	-	-
	HIT-Z <sup>a)</sup>	12,0	19,0	27,0	48,0	73,0	-	-	-
	HAS-D	-	-	34,0	63,0	149,0	-	-	-
<b>Cracked concrete</b>									
Tension	HAS-U 5.8	15,1	21,2	35,2	48,1	76,3	104,8	128,0	152,8
	HAS-U 8.8	15,1	21,2	35,2	48,1	76,3	104,8	128,0	152,8
	HAS-U A4	15,1	21,2	35,2	48,1	76,3	104,8	128,0	152,8
	HAS-U HCR	15,1	21,2	35,2	48,1	76,3	104,8	128,0	152,8
	HIS-N 8.8	24,7	39,7	48,1	76,3	101,1	-	-	-
	HIT-Z <sup>a)</sup>	20,2	29,4	39,7	60,1	83,2	-	-	-
	HAS-D	-	-	34,4	48,1	76,3	-	-	-
Shear	HAS-U 5.8	11,0	17,4	25,3	47,1	73,5	105,9	137,7	168,3
	HAS-U 8.8	14,6	23,2	33,7	62,8	98,0	141,2	183,6	224,4
	HAS-U A4	12,8	20,3	29,5	55,0	85,8	123,6	114,8	140,3
	HAS-U HCR	14,6	23,2	33,7	62,8	98,0	123,6	160,7	196,4
	HIS-N 8.8	13,0	23,0	34,0	63,0	58,0	-	-	-
	HIT-Z <sup>a)</sup>	12,0	19,0	27,0	48,0	73,0	-	-	-
	HAS-D	-	-	34,0	63,0	149,0	-	-	-

a) Hilti anchor rod HIT-Z-F: M16 and M20.

**Design resistance**

Anchor size		M8	M10	M12	M16	M20	M24	M27	M30		
<b>Uncracked concrete</b>											
Tension	HAS-U 5.8	N <sub>Rd</sub>	[kN]	12,2	19,3	28,1	45,8	72,7	99,8	121,9	145,5
	HAS-U 8.8			19,5	28,0	37,8	45,8	72,7	99,8	121,9	145,5
	HAS-U A4			13,7	21,7	31,6	45,8	72,7	99,8	80,2	98,1
	HAS-U HCR			19,5	28,0	37,8	45,8	72,7	99,8	121,9	145,5
	HIS-N 8.8			16,7	30,7	44,7	72,7	77,3	-	-	-
	HIT-Z <sup>a)</sup>			16,0	25,3	33,3	57,3	79,2	-	-	-
	HAS-D			-	-	32,8	45,8	72,7	-	-	-
Shear	HAS-U 5.8	V <sub>Rd</sub>	[kN]	8,8	13,9	20,2	37,7	58,8	84,7	110,2	134,6
	HAS-U 8.8			11,7	18,6	27,0	50,2	78,4	113,0	146,9	179,5
	HAS-U A4			8,2	13,0	18,9	35,2	55,0	79,2	48,2	58,9
	HAS-U HCR			11,7	18,6	27,0	50,2	78,4	70,6	91,8	112,2
	HIS-N 8.8			10,4	18,4	27,2	50,4	46,4	-	-	-
	HIT-Z <sup>a)</sup>			9,6	15,2	21,6	38,4	58,4	-	-	-
	HAS-D			-	-	27,2	50,4	119,2	-	-	-
<b>Cracked concrete</b>											
Tension	HAS-U 5.8	N <sub>Rd</sub>	[kN]	10,0	14,1	23,5	32,1	50,9	69,9	85,4	101,8
	HAS-U 8.8			10,0	14,1	23,5	32,1	50,9	69,9	85,4	101,8
	HAS-U A4			10,0	14,1	23,5	32,1	50,9	69,9	80,2	98,1
	HAS-U HCR			10,0	14,1	23,5	32,1	50,9	69,9	85,4	101,8
	HIS-N 8.8			16,5	26,5	32,1	50,9	67,4	-	-	-
	HIT-Z <sup>a)</sup>			13,4	19,6	26,5	40,1	55,4	-	-	-
	HAS-D			-	-	22,9	32,1	50,9	-	-	-
Shear	HAS-U 5.8	V <sub>Rd</sub>	[kN]	8,8	13,9	20,2	37,7	58,8	84,7	110,2	134,6
	HAS-U 8.8			11,7	18,6	27,0	50,2	78,4	113,0	146,9	179,5
	HAS-U A4			8,2	13,0	18,9	35,2	55,0	79,2	48,2	58,9
	HAS-U HCR			11,7	18,6	27,0	50,2	78,4	70,6	91,8	112,2
	HIS-N 8.8			10,4	18,4	27,2	50,4	46,4	-	-	-
	HIT-Z <sup>a)</sup>			9,6	15,2	21,6	38,4	58,4	-	-	-
	HAS-D			-	-	27,2	50,4	101,8	-	-	-

a) Hilti anchor rod HIT-Z-F: M16 and M20.

**Recommended loads <sup>b)</sup>**

Anchor size				M8	M10	M12	M16	M20	M24	M27	M30
<b>Uncracked concrete</b>											
Tension	HAS-U 5.8	N <sub>Rd</sub>	[kN]	8,7	13,8	20,1	32,7	51,9	71,3	87,1	103,9
	HAS-U 8.8			13,9	20,0	27,0	32,7	51,9	71,3	87,1	103,9
	HAS-U A4			9,8	15,5	22,5	32,7	51,9	71,3	57,3	70,1
	HAS-U HCR			13,9	20,0	27,0	32,7	51,9	71,3	87,1	103,9
	HIS-N 8.8			11,9	21,9	31,9	51,9	55,2	-	-	-
	HIT-Z <sup>a)</sup>			11,4	18,1	23,8	40,9	56,6	-	-	-
	HAS-D			-	-	23,4	32,7	51,9	-	-	-
Shear	HAS-U 5.8	V <sub>Rd</sub>	[kN]	6,3	9,9	14,5	26,9	42,0	60,5	78,7	96,2
	HAS-U 8.8			8,4	13,3	19,3	35,9	56,0	80,7	104,9	128,2
	HAS-U A4			5,9	9,3	13,5	25,2	39,3	56,6	34,4	42,1
	HAS-U HCR			8,4	13,3	19,3	35,9	56,0	50,4	65,6	80,1
	HIS-N 8.8			7,4	13,1	19,4	36,0	33,1	-	-	-
	HIT-Z <sup>a)</sup>			6,9	10,9	15,4	27,4	41,7	-	-	-
	HAS-D			-	-	19,4	36,0	85,1	-	-	-
<b>Cracked concrete</b>											
Tension	HAS-U 5.8	N <sub>Rd</sub>	[kN]	7,2	10,1	16,8	22,9	36,3	49,9	61,0	72,7
	HAS-U 8.8			7,2	10,1	16,8	22,9	36,3	49,9	61,0	72,7
	HAS-U A4			7,2	10,1	16,8	22,9	36,3	49,9	57,3	70,1
	HAS-U HCR			7,2	10,1	16,8	22,9	36,3	49,9	61,0	72,7
	HIS-N 8.8			11,8	18,9	22,9	36,3	48,1	-	-	-
	HIT-Z <sup>a)</sup>			9,6	14,0	18,9	28,6	39,6	-	-	-
	HAS-D			-	-	16,4	22,9	36,3	-	-	-
Shear	HAS-U 5.8	V <sub>Rd</sub>	[kN]	6,3	9,9	14,5	26,9	42,0	60,5	78,7	96,2
	HAS-U 8.8			8,4	13,3	19,3	35,9	56,0	80,7	104,9	128,2
	HAS-U A4			5,9	9,3	13,5	25,2	39,3	56,6	34,4	42,1
	HAS-U HCR			8,4	13,3	19,3	35,9	56,0	50,4	65,6	80,1
	HIS-N 8.8			7,4	13,1	19,4	36,0	48,1	-	-	-
	HIT-Z <sup>a)</sup>			6,9	10,9	15,4	27,4	41,7	-	-	-
	HAS-D			-	-	19,4	36,0	72,7	-	-	-

a) Hilti anchor rod HIT-Z-F: M16 and M20;

b) With overall partial safety factor for action  $\gamma = 1,4$ . The partial safety factors for action depend on the type of loading and shall be taken from national regulations.

### Seismic resistance (for a single anchor)

#### All data in this section applies to:

- Correct setting (See setting instruction with hammer drilling)
- No edge distance and spacing influence
- Steel failure
- Minimum base material thickness
- Concrete C 20/25
- Temperature range I (min. base material temp.  $-40^{\circ}\text{C}$ , max. long/short term base material temp.:  $+24^{\circ}\text{C}/40^{\circ}\text{C}$ )
- Installation temperature range  $-10^{\circ}\text{C}$  to  $+40^{\circ}\text{C}$  (for HAS-U) or  $+5^{\circ}\text{C}$  to  $+40^{\circ}\text{C}$  (for HIT-Z)
- $\alpha_{\text{gap}} = 1,0$  (using Hilti seismic filling set) or  $\alpha_{\text{gap}} = 0,5$  (without using Hilti seismic filling set) accordingly

#### For hammer drilled holes and hammer drilled holes with Hilti hollow drill bit:

#### Anchorage depth for seismic C2

Anchor size		M8	M10	M12	M16	M20	M24	M27	M30
<b>HAS-U</b>									
Embedment depth	$h_{\text{ef}}$ [mm]	-	-	-	125	170	210	-	-
Base material thickness	$h$ [mm]	-	-	-	160	220	270	-	-
<b>HIT-Z</b>									
Embedment depth	$h_{\text{ef}}$ [mm]	-	-	110	145	180	-	-	-
Base material thickness	$h$ [mm]	-	-	170	245	280	-	-	-

#### Characteristic resistance in case of seismic performance category C2

Anchor size		M8	M10	M12	M16	M20	M24	M27	M30	
Tension	HAS-U 8.8	$N_{\text{Rk,seis}}$ [kN]	-	-	-	24,5	45,9	55,4	-	-
	HIT-Z <sup>a)</sup>		-	-	22,0	51,1	70,7	-	-	-
<b>with Hilti filling set</b>										
Shear	HAS-U 8.8	$V_{\text{Rk,seis}}$ [kN]	-	-	-	46,0	77,0	103,0	-	-
	HIT-Z <sup>a)</sup>		-	-	23,0	41,0	61,0	-	-	-
<b>without Hilti filling set</b>										
Shear	HAS-U 8.8	$V_{\text{Rk,seis}}$ [kN]	-	-	-	20,0	35,5	45,0	-	-
	HIT-Z <sup>a)</sup>		-	-	10,5	18,0	27,5	-	-	-

a) Hilti anchor rod HIT-Z-F: M16 and M20.

#### Design resistance in case of seismic performance category C2

Anchor size		M8	M10	M12	M16	M20	M24	M27	M30	
Tension	HAS-U 8.8	$N_{\text{Rd,seis}}$ [kN]	-	-	-	16,3	30,6	36,9	-	-
	HIT-Z <sup>a)</sup>		-	-	14,7	34,1	47,1	-	-	-
<b>with Hilti filling set</b>										
Shear	HAS-U 8.8	$V_{\text{Rd,seis}}$ [kN]	-	-	-	36,8	61,6	82,4	-	-
	HIT-Z <sup>a)</sup>		-	-	18,4	32,8	48,8	-	-	-
<b>without Hilti filling set</b>										
Shear	HAS-U 8.8	$V_{\text{Rd,seis}}$ [kN]	-	-	-	16,0	28,4	36,0	-	-
	HIT-Z <sup>a)</sup>		-	-	8,4	14,4	22,0	-	-	-

a) Hilti anchor rod HIT-Z-F: M16 and M20.

**Anchorage depth for seismic C1**

Anchor size			M8	M10	M12	M16	M20	M24	M27	M30
<b>HAS-U</b>										
Embedment depth	$h_{ef}$	[mm]	-	90	110	125	170	210	240	270
Base material thickness	$h$	[mm]	-	120	140	160	220	270	300	340
<b>HIT-Z</b>										
Embedment depth	$h_{ef}$	[mm]	70	90	110	145	180	-	-	-
Base material thickness	$h$	[mm]	130	150	170	245	280	-	-	-

**Characteristic resistance in case of seismic performance category C1**

Anchor size			M8	M10	M12	M16	M20	M24	M27	M30
Tension	HAS-U 8.8	$N_{Rk,seis}$ [kN]	-	14,7	29,0	40,9	64,9	89,1	108,8	129,9
	HIT-Z <sup>a)</sup>		17,1	25,0	33,8	51,1	70,7	-	-	-
	HIT-Z-R		17,1	25,0	33,8	51,1	70,7	-	-	-
<b>with Hilti filling set</b>										
Shear	HAS-U 8.8	$V_{Rk,seis}$ [kN]	-	23,2	33,7	62,8	98,0	141,2	183,6	224,4
	HIT-Z <sup>a)</sup>		8,5	12,0	16,0	28,0	45,0	-	-	-
	HIT-Z-R		9,8	15,0	22,0	31,0	48,0	-	-	-
<b>without Hilti filling set</b>										
Shear	HAS-U 8.8	$V_{Rk,seis}$ [kN]	-	11,6	16,9	31,4	49,0	70,6	91,8	112,2
	HIT-Z <sup>a)</sup>		4,3	6,0	8,0	14,0	22,5	-	-	-
	HIT-Z-R		4,9	7,5	11,0	15,5	24,0	-	-	-

a) Hilti anchor rod HIT-Z-F: M16 and M20.

**Design resistance in case of seismic performance category C1**

Anchor size			M8	M10	M12	M16	M20	M24	M27	M30
Tension	HAS-U 8.8	$N_{Rd,seis}$ [kN]	-	9,8	19,4	27,3	43,3	59,4	72,6	86,6
	HIT-Z <sup>a)</sup>		11,4	16,7	22,5	34,1	47,1	-	-	-
	HIT-Z-R		11,4	16,7	22,5	34,1	47,1	-	-	-
<b>with Hilti filling set</b>										
Shear	HAS-U 8.8	$V_{Rd,seis}$ [kN]	-	18,6	27,0	50,2	78,4	113,0	146,9	179,5
	HIT-Z <sup>a)</sup>		6,8	9,6	12,8	22,4	36,0	-	-	-
	HIT-Z-R		7,8	12,0	17,6	24,8	38,4	-	-	-
<b>without Hilti filling set</b>										
Shear	HAS-U 8.8	$V_{Rd,seis}$ [kN]	-	9,3	13,5	25,1	39,2	56,5	73,4	89,8
	HIT-Z <sup>a)</sup>		3,4	4,8	6,4	11,2	18,0	-	-	-
	HIT-Z-R		3,9	6,0	8,8	12,4	19,2	-	-	-

a) Hilti anchor rod HIT-Z-F: M16 and M20.



## Fatigue resistance

### All data in this section applies to:

- Correct setting (See setting instruction)
- No edge distance and spacing influence
- Steel failure
- Minimum base material thickness
- Concrete C 20/25
- In-service temperature range I

(min. base material temp. -40°C, max. long/short term base material temp.: +24°C/40°C)

### Anchorage depth

Anchor size			M12	M16	M20
<b>HAS-D</b>					
Embedment depth	$h_{ef}$	[mm]	100	125	170
Base material thickness	$h$	[mm]	130	160	220
<b>HIT-Z-D TP, HIT-Z-R-D TP</b>					
Embedment depth	$h_{ef}$	[mm]	-	125	-
Base material thickness <sup>a)</sup>	$h$	[mm]	-	160/225 <sup>a)</sup>	-

a) Values show for Drill hole condition (1) and (2) respectively. See setting details

### Characteristic resistance

Anchor size			M12	M16	M20
<b>Non-cracked concrete</b>					
Tension	HAS-D	$\Delta N_{Rk,0,\infty}$ [kN]	20,1	34,0	43,5
	HIT-Z-D TP		-	18,8	-
	HIT-Z-R-D TP		-	12,4	-
Shear	HAS-D	$\Delta V_{Rk,0,\infty}$ [kN]	8,2	15,0	21,1
	HIT-Z-D TP		-	8,0	-
	HIT-Z-R-D TP		-	8,0	-
<b>Cracked concrete</b>					
Tension	HAS-D	$\Delta N_{Rk,0,\infty}$ [kN]	20,1	34,0	43,5
	HIT-Z-D TP		-	18,8	-
	HIT-Z-R-D TP		-	12,4	-
Shear	HAS-D	$\Delta V_{Rk,0,\infty}$ [kN]	8,2	15,0	21,1
	HIT-Z-D TP		-	8,0	-
	HIT-Z-R-D TP		-	8,0	-

### Design resistance

Anchor size			M12	M16	M20
<b>Non-cracked concrete</b>					
Tension	HAS-D	$\Delta N_{Rd,0,\infty}$ [kN]	14,9	25,2	32,2
	HIT-Z-D TP		-	13,9	-
	HIT-Z-R-D TP		-	9,2	-
Shear	HAS-D	$\Delta V_{Rd,0,\infty}$ [kN]	6,1	11,1	15,6
	HIT-Z-D TP		-	5,9	-
	HIT-Z-R-D TP		-	5,9	-
<b>Cracked concrete</b>					
Tension	HAS-D	$\Delta N_{Rd,0,\infty}$ [kN]	14,9	25,2	32,2
	HIT-Z-D TP		-	13,9	-
	HIT-Z-R-D TP		-	9,2	-
Shear	HAS-D	$\Delta V_{Rd,0,\infty}$ [kN]	6,1	11,1	15,6
	HIT-Z-D TP		-	5,9	-
	HIT-Z-R-D TP		-	5,9	-

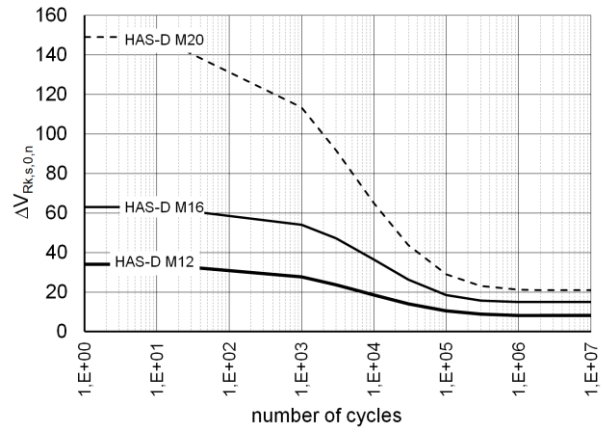
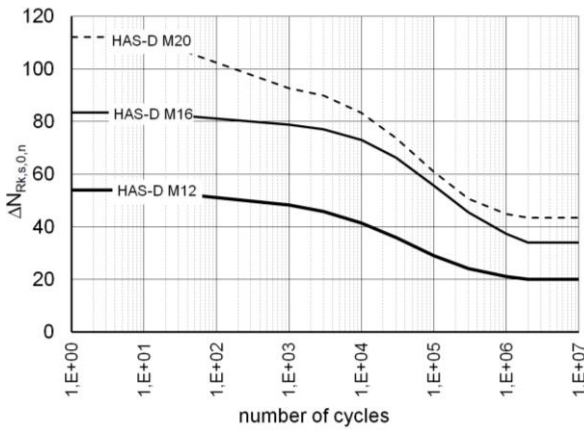
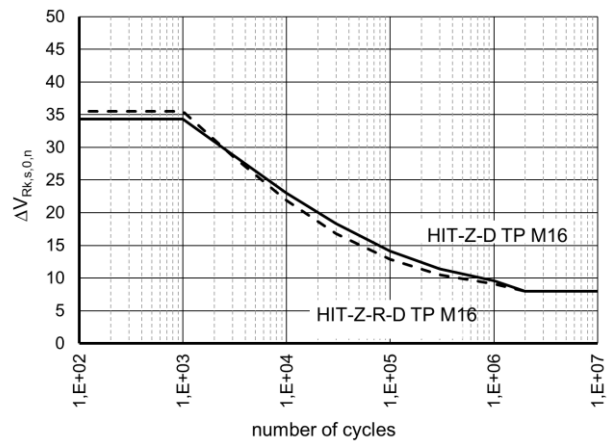
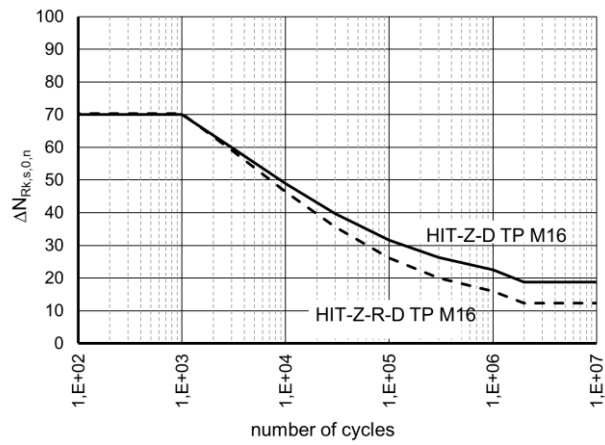
**Characteristic Wöhler curve under tension and shear fatigue load**

**Characteristic Wöhler curve under tension and shear fatigue load**

**Materials**
**Mechanical properties for HAS-U**

Anchor size		M8	M10	M12	M16	M20	M24	M27	M30	
Nominal tensile strength	HAS-U 5.8 (HDG)	$f_{uk}$ [N/mm <sup>2</sup> ]	800	800	800	800	800	800	800	
	HAS-U 8.8 (HDG)									
	AM 8.8 (HDG)									
	HAS-U A4									
	HAS-U HCR	700	700	700	700	700	700	500	500	
Yield strength	HAS-U 5.8 (HDG)	$f_{yk}$ [N/mm <sup>2</sup> ]	640	640	640	640	640	640	640	
	HAS-U 8.8 (HDG)									
	AM 8.8 (HDG)									
	HAS-U A4									
	HAS-U HCR	450	450	450	450	450	450	210	210	
Stressed cross-section	HAS-U	$A_s$ [mm <sup>2</sup> ]	36,6	58,0	84,3	157	245	353	459	561
Moment of resistance	HAS-U	$W$ [mm <sup>3</sup> ]	31,2	62,3	109	277	541	935	1387	1874

**Mechanical properties for HIS-N**

Anchor size		M8	M10	M12	M16	M20	
Nominal tensile strength	HIS-N	$f_{uk}$ [N/mm <sup>2</sup> ]	800	800	800	800	
	Screw 8.8						
	HIS-RN						
	Screw A4-70						
Yield strength	HIS-N	$f_{yk}$ [N/mm <sup>2</sup> ]	390	390	390	390	
	Screw 8.8						
	HIS-RN						
	Screw A4-70						
Stressed cross-section	HIS-(R)N	$A_s$ [mm <sup>2</sup> ]	51,5	108	169	256	238
	Screw		36,6	58,0	84,3	157	245
Moment of resistance	HIS-(R)N	$W$ [mm <sup>3</sup> ]	145	430	840	1595	1543
	Screw		31,2	62,3	109	277	541

**Mechanical properties for HIT-Z**

Anchor size		M8	M10	M12	M16	M20
Nominal tensile strength	HIT-Z(-F) <sup>a)</sup>	$f_{uk}$ [N/mm <sup>2</sup> ]	650	650	650	610
	HIT-Z-R					
Yield strength	HIT-Z(-F) <sup>a)</sup>	$f_{yk}$ [N/mm <sup>2</sup> ]	520	520	520	490
	HIT-Z-R					
Stressed cross-section of thread	HIT-Z(-F) <sup>a)</sup>	$A_s$ [mm <sup>2</sup> ]	36,6	58,0	84,3	157
	HIT-Z-R					
Moment of resistance	HIT-Z(-F) <sup>a)</sup>	$W$ [mm <sup>3</sup> ]	31,9	62,5	109,7	278
	HIT-Z-R					542

a) Hilti anchor rod HIT-Z-F: M16 and M20.

**Material quality for HAS-U**

Part	Material
<b>Zinc coated steel</b>	
Threaded rod, HAS-U 5.8 (HDG)	Strength class 5.8; Elongation at fracture A5 > 8% ductile Electroplated zinc coated $\geq 5\mu\text{m}$ ; (HDG) hot dip galvanized $\geq 45\mu\text{m}$
Threaded rod, HAS-U 8.8 (HDG)	Strength class 8.8; Elongation at fracture A5 > 12% ductile Electroplated zinc coated $\geq 5\mu\text{m}$ ; (HDG) hot dip galvanized $\geq 45\mu\text{m}$
Hilti Meter rod, AM 8.8 (HDG)	Strength class 8.8; Elongation at fracture A5 > 12% ductile Electroplated zinc coated $\geq 5\mu\text{m}$ (HDG) hot dip galvanized $\geq 45\mu\text{m}$
Washer	Electroplated zinc coated $\geq 5\mu\text{m}$ , hot dip galvanized $\geq 45\mu\text{m}$
Nut	Strength class of nut adapted to strength class of threaded rod. Electroplated zinc coated $\geq 5\mu\text{m}$ , (HDG) hot dip galvanized $\geq 45\mu\text{m}$
Hilti Filling set (F)	Filling washer: Electroplated zinc coated $\geq 5\mu\text{m}$ / (HDG) Hot dip galvanized $\geq 45\mu\text{m}$
	Spherical washer: Electroplated zinc coated $\geq 5\mu\text{m}$ / (HDG) Hot dip galvanized $\geq 45\mu\text{m}$
	Lock nut: Electroplated zinc coated $\geq 5\mu\text{m}$ / (HDG) Hot dip galvanized $\geq 45\mu\text{m}$
<b>Stainless Steel</b>	
Threaded rod, HAS-U A4	Strength class 70 for $\leq M24$ and strength class 50 for $> M24$ ; Elongation at fracture A5 > 8% ductile Stainless steel 1.4401; 1.4404; 1.4578; 1.4571; 1.4439; 1.4362 EN 10088-1:2014
Washer	Stainless steel 1.4401, 1.4404, 1.4578, 1.4571, 1.4439, 1.4362 EN 10088-1:2014
Nut	Stainless steel 1.4401, 1.4404, 1.4578, 1.4571, 1.4439, 1.4362 EN 10088-1:2014
<b>High corrosion resistant steel</b>	
Threaded rod, HAS-U HCR	Strength class 80 for $\leq M20$ and class 70 for $> M20$ , Elongation at fracture A5 > 8% ductile High corrosion resistant steel 1.4529, 1.4565 EN 10088-1:2014
Washer	High corrosion resistant steel 1.4529, 1.4565 EN 10088-1:2014
Nut	High corrosion resistant steel 1.4529, 1.4565 EN 10088-1:2014

**Material quality for HIS-N**

Part	Material	
HIS-N	Int. threaded sleeve	Electroplated zinc coated $\geq 5\mu\text{m}$
	Screw 8.8	Strength class 8.8, A5 > 8 % Ductile; Steel galvanized $\geq 5\mu\text{m}$
HIS-RN	Int. threaded sleeve	Stainless steel 1.4401, 1.4571 EN 10088-1:2014
	Screw 70	Strength class 70, A5 > 8 % Ductile; Stainless steel 1.4401; 1.4404, 1.4578; 1.4571; 1.4439; 1.4362

**Material quality for HIT-Z**

Part	Material
Threaded rod HIT-Z	Elongation at fracture > 8% ductile; Electroplated zinc coated $\geq 5\mu\text{m}$
Washer	Electroplated zinc coated $\geq 5\mu\text{m}$
Nut	Strength class of nut adapted to strength class of anchor rod. Electroplated zinc coated $\geq 5\mu\text{m}$
HIT-Z-F	Elongation at fracture > 8% ductile Multilayer coating, ZnNi-galvanized according to DIN 50979:2008-07
Washer	Multilayer coating, ZnNi-galvanized according to DIN 50979:2008-07
Nut	Multilayer coating, ZnNi-galvanized according to DIN 50979:2008-07
HIT-Z-R	Elongation at fracture > 8% ductile; Stainless steel 1.4401, 1.4404 EN 10088-1:2014
Washer	Stainless steel A4 according to EN 10088-1:2014
Nut	Strength class of nut adapted to strength class of anchor rod. Stainless steel 1.4401, 1.4404 EN 10088-1:2014

### Material quality for HAS-D

Part	Material
Fastener	Steel according to EN 10087:1998, galvanized and coated
Sealing washer	Steel, electroplated zinc coated $\geq 5 \mu\text{m}$
Calotte nut	Steel, electroplated zinc coated $\geq 5 \mu\text{m}$
Lock nut	Steel, electroplated zinc coated $\geq 5 \mu\text{m}$

### Setting information

#### Installation temperature:

- $-10\text{ °C}$  to  $+40\text{ °C}$  (for HAS-U, HAS-D, HIS-N)
- $+5\text{ °C}$  to  $+40\text{ °C}$  (for HIT-Z, HIT-Z-D)

#### In service temperature range

Hilti HIT-HY 200 A (R) injection mortar may be applied in the temperature ranges given below. An elevated base material temperature leads to a reduction of the design bond resistance.

#### Temperature in the base material

Temperature range	Base material temperature	Maximum long term base material temperature	Maximum short term base material temperature
Temperature range I	$-40\text{ °C}$ to $+40\text{ °C}$	$+24\text{ °C}$	$+40\text{ °C}$
Temperature range II	$-40\text{ °C}$ to $+80\text{ °C}$	$+50\text{ °C}$	$+80\text{ °C}$
Temperature range III	$-40\text{ °C}$ to $+120\text{ °C}$	$+72\text{ °C}$	$+120\text{ °C}$

#### Maximum short term base material temperature

Short-term elevated base material temperatures are those that occur over brief intervals, e.g. as a result of diurnal cycling.

#### Maximum long term base material temperature

Long-term elevated base material temperatures are roughly constant over significant periods of time.

### Curing and working time

Temperature of the base material <sup>a)</sup>	HIT-HY 200-A		HIT-HY 200-R		HIT-HY 200-R V3	
	Maximum working time	Minimum curing time	Maximum working time	Minimum curing time	Maximum working time	Minimum curing time
$T_{\text{BM}}$	$t_{\text{work}}$	$t_{\text{cure}}$	$t_{\text{work}}$	$t_{\text{cure}}$	$t_{\text{work}}$	$t_{\text{cure}}$
$-10\text{ °C} < T_{\text{BM}} \leq -5\text{ °C}$ <sup>a)</sup>	1,5 h	7 h	3 h	20 h	3 h	20 h
$-5\text{ °C} < T_{\text{BM}} \leq 0\text{ °C}$ <sup>a)</sup>	50 min	4 h	2 h	8 h	1,5 h	8 h
$0\text{ °C} < T_{\text{BM}} \leq 5\text{ °C}$ <sup>a)</sup>	25 min	2 h	1 h	4 h	45 min	4 h
$5\text{ °C} < T_{\text{BM}} \leq 10\text{ °C}$	15 min	75 min	40 min	2,5 h	30 min	2,5 h
$10\text{ °C} < T_{\text{BM}} \leq 20\text{ °C}$	7 min	45 min	15 min	1,5 h	15 min	1,5 h
$20\text{ °C} < T_{\text{BM}} \leq 30\text{ °C}$	4 min	30 min	9 min	1 h	9 min	1 h
$30\text{ °C} < T_{\text{BM}} \leq 40\text{ °C}$	3 min	30 min	6 min	1 h	6 min	1 h

a) Installation of HIT-Z, HIT-Z-D only in range  $+5\text{ °C}$  to  $+40\text{ °C}$

**Setting details for HAS-U**

Anchor size			M8	M10	M12	M16	M20	M24	M27	M30
Nominal diameter of drill bit	$d_0$	[mm]	10	12	14	18	22	28	30	35
Effective embedment depth (= drill hole depth) <sup>a)</sup>	$h_{ef,min} = h_0$	[mm]	60	60	70	80	90	96	108	120
	$h_{ef,max} = h_0$	[mm]	160	200	240	320	400	480	540	600
Minimum base material thickness	$h_{min}$	[mm]	$h_{ef} + 30 \text{ mm} \geq 100 \text{ mm}$			$h_{ef} + 2 d_0$				
Maximum diameter of clearance hole in the fixture	$d_f$	[mm]	9	12	14	18	22	26	30	33
Thickness of Hilti filling set	$h_{fs}$	[mm]	-	-	-	11	13	15	-	-
Effective fixture thickness with Hilti filling set	$t_{fix,eff}$	[mm]	$t_{fix} - h_{fs}$							
Maximum torque moment <sup>b)</sup>	$T_{max}$	[Nm]	10	20	40	80	150	200	270	300
Minimum spacing	$s_{min}$	[mm]	40	50	60	75	90	115	120	140
Minimum edge distance	$c_{min}$	[mm]	40	45	45	50	55	60	75	80
Critical spacing for splitting failure	$s_{cr,sp}$	[mm]	$2 C_{cr,sp}$							
Critical edge distance for splitting failure <sup>c)</sup>	$C_{cr,sp}$	[mm]	$1,0 \cdot h_{ef}$		for $h / h_{ef} \geq 2,00$					
			$4,6 h_{ef} - 1,8 h$		for $2,0 > h / h_{ef} > 1,3$					
			$2,26 h_{ef}$		for $h / h_{ef} \leq 1,3$					
Critical spacing for concrete cone failure	$s_{cr,N}$	[mm]	$2 C_{cr,N}$							
Critical edge distance for concrete cone failure	$C_{cr,N}$	[mm]	$1,5 h_{ef}$							

For spacing (edge distance) smaller than critical spacing (critical edge distance) the design loads have to be reduced.

a)  $h_{ef,min} \leq h_{ef} \leq h_{ef,max}$  ( $h_{ef}$ : embedment depth).

b) Maximum recommended torque moment to avoid splitting failure during installation with minimum spacing and edge distance.

c)  $h$ : base material thickness ( $h \geq h_{min}$ ).

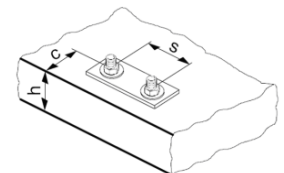
**HAS-U-...**

**Marking:**

Steel grade number and length identification letter: e.g. 8L

**Setting details for HIS-N**

Anchor size		M8	M10	M12	M16	M20
Nominal diameter of drill bit	$d_0$ [mm]	14	18	22	28	32
Diameter of element	$d$ [mm]	12,5	16,5	20,5	25,4	27,6
Effective embedment depth (=drill hole depth)	$h_{ef} = h_0$ [mm]	90	110	125	170	205
Minimum base material thickness	$h_{min}$ [mm]	120	150	170	230	270
Diameter of clearance hole in the fixture	$d_f$ [mm]	9	12	14	18	22
Thread engagement length; min - max	$h_s$ [mm]	8-20	10-25	12-30	16-40	20-50
Maximum torque moment <sup>b)</sup>	$T_{max}$ [Nm]	10	20	40	80	150
Minimum spacing	$s_{min}$ [mm]	60	75	90	115	130
Minimum edge distance	$c_{min}$ [mm]	40	45	55	65	90
Critical spacing for splitting failure	$s_{cr,sp}$ [mm]	$2 C_{cr,sp}$				
Critical edge distance for splitting failure <sup>a)</sup>	$C_{cr,sp}$ [mm]	$1,0 \cdot h_{ef}$ for $h / h_{ef} \geq 2,0$				
		$4,6 h_{ef} - 1,8 h$ for $2,0 > h / h_{ef} > 1,3$				
		$2,26 h_{ef}$ for $h / h_{ef} \leq 1,3$				
Critical spacing for concrete cone failure	$s_{cr,N}$ [mm]	$2 C_{cr,N}$				
Critical edge distance for concrete cone failure	$C_{cr,N}$ [mm]	$1,5 h_{ef}$				

For spacing (edge distance) smaller than critical spacing (critical edge distance) the design loads have to be reduced.

a)  $h$ : base material thickness ( $h \geq h_{min}$ ).

b) Max. recommended torque moment to avoid splitting failure during Installation with minimum spacing and edge distance.

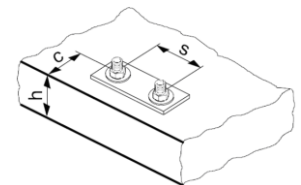
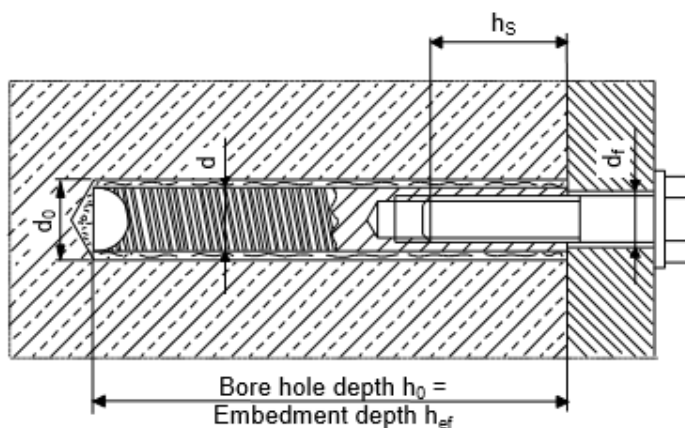

**Setting details for HIT-Z, HIT-Z-F and HIT-Z-R**

Anchor size		M8	M10	M12	M16	M20
Nominal diameter of drill bit	$d_0$ [mm]	10	12	14	18	22
Length of anchor	min l [mm]	80	95	105	155	215
	max l [mm]	120	160	196	420	450
Nominal embedment depth <sup>a)</sup>	$h_{nom,min}$ [mm]	60	60	60	96	100
	$h_{nom,max}$ [mm]	100	120	144	192	220
Borehole condition 1 Min. base material thickness	$h_{min}$ [mm]	$h_{nom} + 60$ mm			$h_{nom} + 100$ mm	
Borehole condition 2 Min. base material thickness	$h_{min}$ [mm]	$h_{nom} + 30$ mm $\geq 100$ mm			$h_{nom} + 45$ mm	
Maximum depth of drill hole	$h_0$ [mm]	$h - 30$ mm			$h - 2 d_0$	
Pre-setting: Diameter of clearance hole in the fixture	$d_f$ [mm]	9	12	14	18	22
Through-setting: Diameter of clearance hole in the fixture	$d_f$ [mm]	11	14	16	20	24
Maximum fixture thickness	$t_{fix}$ [mm]	48	87	120	303	326
Maximum fixture thickness with seismic filling set	$t_{fix}$ [mm]	41	79	111	292	314
Installation torque moment <sup>b)</sup>	HIT-Z, HIT-Z-F $T_{inst}$ [Nm]	10	25	40	80	150
	HIT-Z-R $T_{inst}$ [Nm]	30	55	75	155	215
Critical spacing for splitting failure	$s_{cr,sp}$ [mm]	$2 C_{cr,sp}$				
Critical edge distance for splitting failure <sup>c)</sup>	$c_{cr,sp}$ [mm]	$1,5 \cdot h_{nom}$		for $h / h_{nom} \geq 2,35$		
		$6,2 h_{nom} - 2,0 h$		for $2,35 > h / h_{nom} > 1,35$		
		$3,5 h_{nom}$		for $h / h_{nom} \leq 1,35$		
Critical spacing for concrete cone failure	$s_{cr,N}$ [mm]	$2 C_{cr,N}$				
Critical edge distance concrete cone failure	$c_{cr,N}$ [mm]	$1,5 h_{nom}$				

For spacing (edge distance) smaller than critical spacing (critical edge distance) the design loads have to be reduced.

a)  $h_{nom,min} \leq h_{nom} \leq h_{nom,max}$  ( $h_{nom}$ : embedment depth).

b) Recommended torque moment to avoid splitting failure during installation with minimum spacing and edge distance.

c)  $h$ : base material thickness ( $h \geq h_{min}$ ).

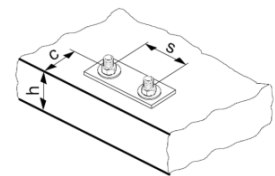



**Pre-setting:**

Install anchor before positioning fixture

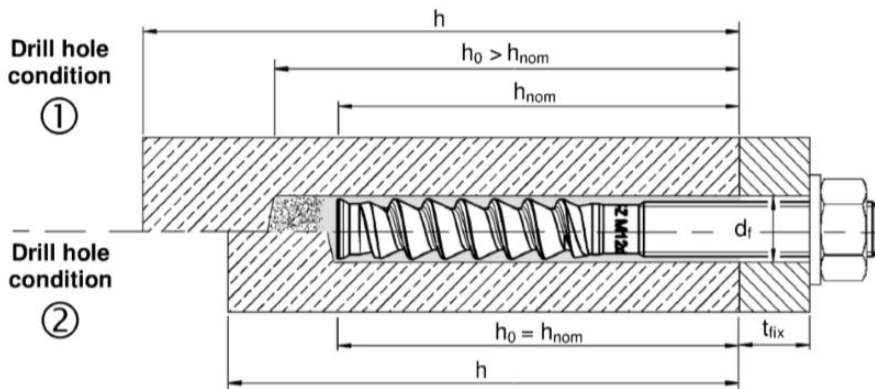

Drill hole condition 1 → non-cleaned borehole

Drill hole condition 2 → drilling dust is completely removed

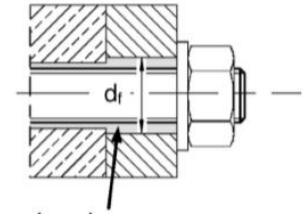
**Through-setting:** Install anchor through positioned fixture

Annular gap filled with Hilti HIT-HY 200-A

**Anchor dimension for HIT-Z**

Anchor size			M8	M10	M12	M16	M20
Length of anchor	min $l$	[mm]	80	95	105	155	215
	max $l$		120	160	196	420	450
Helix length	$l_{\text{Helix}}$	[mm]	30 or 50	50 or 60	60	96	100

Combine with another table (setting details)

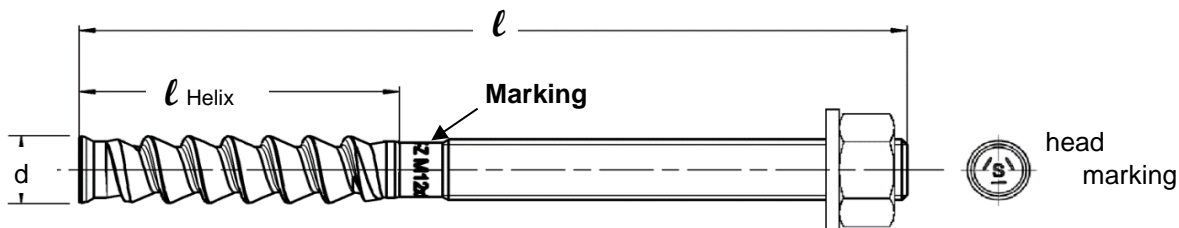
**Minimum edge distance and spacing for HIT-Z**

 For the calculation of minimum spacing and minimum edge distance of anchors in combination with different embedment depth and thickness of concrete member the following equation shall be fulfilled:  $A_{i,\text{req}} < A_{i,\text{cal}}$ 
**Required interaction area  $A_{i,\text{cal}}$  for HIT-Z**

Anchor size			M8	M10	M12	M16	M20
Cracked concrete	[mm <sup>2</sup> ]		19200	40800	58800	94700	148000
Non-cracked concrete	[mm <sup>2</sup> ]		22200	57400	80800	128000	198000

Combine with another table (setting details)

**Effective area  $A_{i,ef}$  of HIT-Z**

Member thickness $h \geq h_{nom} + 1,5 \cdot c$		
Single anchor and group of anchors with $s > 3 \cdot c$	[mm <sup>2</sup> ]	$A_{i,cal} = (6 \cdot c) \cdot (h_{nom} + 1,5 \cdot c)$ with $c \geq 5 \cdot d$
Group of anchors with $s \leq 3 \cdot c$	[mm <sup>2</sup> ]	$A_{i,cal} = (3 \cdot c + s) \cdot (h_{nom} + 1,5 \cdot c)$ with $c \geq 5 \cdot d$ and $s \geq 5 \cdot d$
Member thickness $h \leq h_{nom} + 1,5 \cdot c$		
Single anchor and group of anchors with $s >$	[mm <sup>2</sup> ]	$A_{i,cal} = (6 \cdot c) \cdot h$ with $c \geq 5 \cdot d$
Group of anchors with $s \leq 3 \cdot c$	[mm <sup>2</sup> ]	$A_{i,cal} = (3 \cdot c + s) \cdot h$ with $c \geq 5 \cdot d$ and $s \geq 5 \cdot d$

**Best case minimum edge distance and spacing with required member thickness and embedment depth**

Anchor size		M8	M10	M12	M16	M20
<b>Cracked concrete</b>						
Member thickness	$h \geq$ [mm]	140	200	240	300	370
Embedment depth	$h_{nom} \geq$ [mm]	80	120	150	200	220
Minimum spacing	$s_{min}$ [mm]	40	50	60	80	100
Corresponding edge distance	$c \geq$ [mm]	40	55	65	80	100
Minimum edge distance	$c_{min} =$ [mm]	40	50	60	80	100
Corresponding spacing	$s \geq$ [mm]	40	60	65	80	100
<b>Non-cracked concrete</b>						
Member thickness	$h \geq$ [mm]	140	230	270	340	410
Embedment depth	$h_{nom} \geq$ [mm]	80	120	150	200	220
Minimum spacing	$s_{min}$ [mm]	40	50	60	80	100
Corresponding edge distance	$c \geq$ [mm]	40	70	80	100	130
Minimum edge distance	$c_{min}$ [mm]	40	50	60	80	100
Corresponding spacing	$s \geq$ [mm]	40	145	160	160	235

**Best case minimum member thickness and embedment depth with required minimum edge distance and spacing (borehole condition 1)**

Anchor size			M8	M10	M12	M16	M20
<b>Cracked concrete</b>							
Member thickness	$h \geq$	[mm]	120	120	120	196	200
Embedment depth	$h_{nom} \geq$	[mm]	60	60	60	96	100
Minimum spacing	$s_{min}$	[mm]	40	50	60	80	100
Corresponding edge distance	$c \geq$	[mm]	40	100	140	135	215
Minimum edge distance	$c_{min} =$	[mm]	40	60	90	80	125
Corresponding spacing	$s \geq$	[mm]	40	160	220	235	365
<b>Non cracked concrete</b>							
Member thickness	$h \geq$	[mm]	120	120	120	196	200
Embedment depth	$h_{nom} \geq$	[mm]	60	60	60	96	100
Minimum spacing	$s_{min}$	[mm]	40	50	60	80	100
Corresponding edge distance	$c \geq$	[mm]	50	145	200	190	300
Minimum edge distance	$c_{min}$	[mm]	40	80	115	110	165
Corresponding spacing	$s \geq$	[mm]	65	240	330	310	495

**Minimum edge distance and spacing – Explanation**

Minimum edge and spacing geometrical requirements are determined by testing the installation conditions in which two anchors with a given spacing can be set close to an edge without forming a crack in the concrete due to tightening torque.

The HIT-Z boundary conditions for edge and spacing geometry can be found in the tables to the left. If the embedment depth and slab thickness are equal to or greater than the values in the table, then the edge and spacing values may be utilized.

**PROFIS Anchor software is programmed to calculate the referenced equations in order to determine the optimized related minimum edge and spacing based on the following variables:**

<b><u>Cracked or non-cracked concrete</u></b>	For cracked concrete it is assumed that a reinforcement is present which limits the crack width to 0,3 mm, allowing smaller values for minimum edge distance and minimum spacing
<b><u>Anchor diameter</u></b>	For smaller anchor diameter a smaller installation torque is required, allowing smaller values for minimum edge distance and minimum spacing
<b><u>Slab thickness and embedment depth</u></b>	Increasing these values allows smaller values for minimum edge distance and minimum spacing

**Setting details for HAS-D**

Anchor size		M12	M16	M20
Nominal diameter of drill bit	$d_0$ [mm]	14	18	24
Diameter of element	$d = d_{nom}$ [mm]	12	16	20
Effective anchorage depth (=drill hole depth)	$h_{ef} = h_0$ [mm]	100	125	170
Minimum drill hole depth	$h_0$ [mm]	105	133	180
Minimum base material thickness	$h_{min}$ [mm]	130	160 <sup>1)</sup> / 170	220 <sup>1)</sup> / 230
Pre-setting: Maximum diameter of clearance hole in the fixture	$d_f$ [mm]	14	18	24
Through-setting: Maximum diameter of clearance hole in the fixture	$d_f$ [mm]	16	20	26
Fixture thickness	$t_{fix,min}$ [mm]	12	16	20
	$t_{fix,max}$ [mm]	200		
Installation torque moment	$T_{inst}$ [Nm]	30	50	80
Uncracked concrete	Minimum spacing	$s_{min}$ [mm]	80 <sup>2)</sup>	60
	Minimum edge distance	$c_{min}$ [mm]	55 <sup>2)</sup>	60
Cracked concrete	Minimum spacing	$s_{min}$ [mm]	50	60
	Minimum edge distance	$c_{min}$ [mm]	50	60

1) The reverse side of the concrete member shall have no break-through after drilling.

2) For min. edge distance  $c_{min} \geq 80$  mm, min. spacing  $s_{min} = 55$  mm.

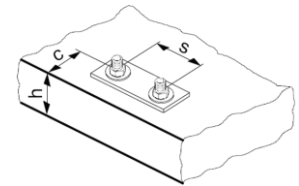
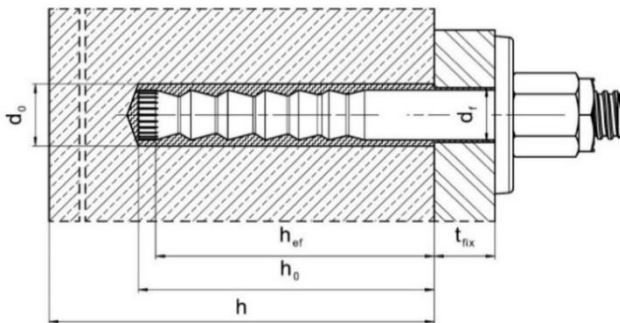
**Anchor dimension for HAS-D**

Anchor size		M12	M16	M20
Shaft diameter	$d_k$ [mm]	12,5	16,5	22,0
Fastener length l	$\geq$ [mm]	143	180	242
	$\leq$ [mm]	531	565	623
Calotte nut	SW [mm]	18/19	24	30
Lock nut	SW [mm]	19	24	30

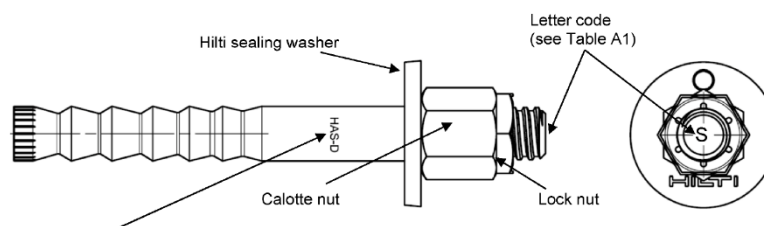

**Marking:**  
HAS-D M...xL Bonded expansion anchor type as well as bonded expansion anchor size and length

**Installation equipment**

Anchor size		M8	M10	M12	M16	M20	M24	M27	M30
Rotary hammer	HAS-U, HAS-D	TE 2 – TE 16				TE 40 - TE 80			
	HIT-Z	TE 2 – TE 40			TE 40 – TE 80		-		
	HIS-N	TE (-A) – TE 16(-A)		TE 40 – TE 80			-		
Other tools		blow out pump ( $h_{ef} \leq 10 \cdot d$ , $d_0 \leq 20$ mm) , compressed air gun, set of cleaning brushes, dispenser Hollow Drill Bit							
		roughening tools TE-YRT							
Additional Hilti recommended tools		DD EC-1, DD 100 ... DD 160 <sup>a)</sup>							

a) In case without roughentning – diamond coring is applicable only for HIT-Z installation

**Cleaning, drilling and installation parameters**



HAS-U	HIT-Z, HIT-Z-D <sup>b)</sup>	HAS-D	HIS-N	Drilling				Cleaning and installation	
				Hammer drill (HD)	Hollow Drill Bit (HDB)	Diamond coring		Brush HIT-RB	Piston plug HIT-SZ
						Diamond coring (DD) <sup>c)</sup>	With roughening tool (RT)		
				$d_0$ [mm]				Size [mm]	
<b>M8</b>	<b>M8</b>	-	-	10	-	10	-	10	-
<b>M10</b>	<b>M10</b>	-	-	12	12	12	-	12	12
<b>M12</b>	<b>M12</b>	<b>M12</b>	<b>M8</b>	14	14	14	-	14	14
<b>M16</b>	<b>M16</b>	<b>M16</b>	<b>M10</b>	18	18	18	18	18	18
<b>M20</b>	<b>M20</b>	<b>M20</b>	<b>M12</b>	22 / 24 <sup>a)</sup>	22 / 24 <sup>a)</sup>	22 / 24 <sup>a)</sup>	22	22 / 24 <sup>a)</sup>	22 / 24 <sup>a)</sup>
<b>M24</b>	-	-	<b>M16</b>	28	28	28	28	28	28
<b>M27</b>	-	-	-	30	-	30	30	30	30
-	-	-	<b>M20</b>	32	32	32	32	32	32
<b>M30</b>	-	-	-	35	35	35	35	35	35

a) Only for HAS-D.

b) HIT-Z-D only available for M16.

c) Diamond cored holes without roughening can be used only for HIT-Z installation

**Associated components for the use of Hilti Roughening tool TE-YRT**

Diamond coring		Roughening tool TE-YRT	Wear gauge RTG...
			
d <sub>0</sub> [mm]		d <sub>0</sub> [mm]	size
Nominal	measured		
18	17,9 to 18,2	18	18
20	19,9 to 20,2	20	20
22	21,9 to 22,2	22	22
25	24,9 to 25,2	25	25
28	27,9 to 28,2	28	28
30	29,9 to 30,2	30	30
32	31,9 to 32,2	32	32
35	34,9 to 35,2	35	35

**Installation parameters for use of the Hilti Roughening tool TE-YRT**

h <sub>ef</sub> [mm]	Minimum roughening time t <sub>roughen</sub> [sec] (t <sub>roughen</sub> [sec] = h <sub>ef</sub> [mm] / 10)	Minimum blowing time t <sub>blowing</sub> [sec] (t <sub>blowing</sub> [sec] = t <sub>roughen</sub> [sec] + 20)
0 to 100	10	30
101 to 200	20	40
201 to 300	30	50
301 to 400	40	60
401 to 500	50	70
501 to 600	60	80

**Setting instructions for HAS-U rods and HIS-N internally threaded sleeves**

\*For detailed information on installation see instruction for use given with the package of the product

**Safety regulations.**

Review the Material Safety Data Sheet (MSDS) before use for proper and safe handling! Wear well-fitting protective goggles and protective gloves when working with Hilti HIT-HY 200 A (R).

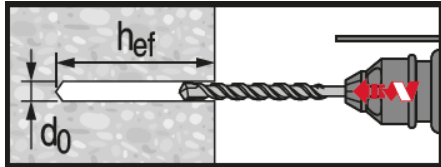
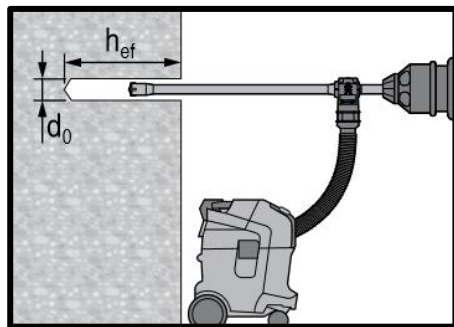
**Drilling**

**Hammer drilled hole (HD)**

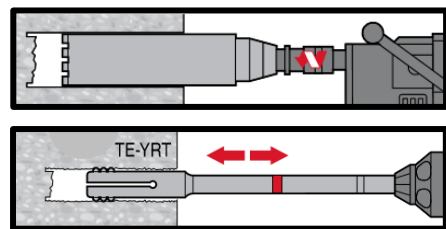
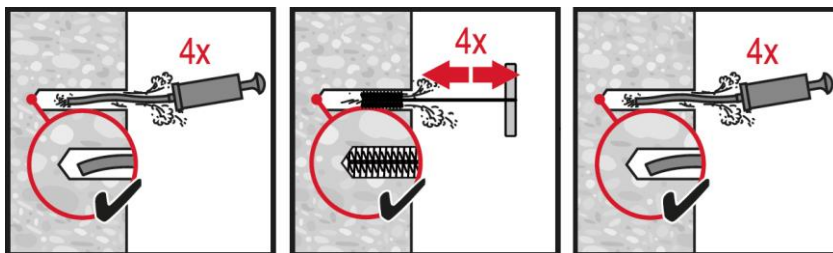
**Hammer drilled hole with Hollow Drilled Bit (HDB)**

No cleaning required

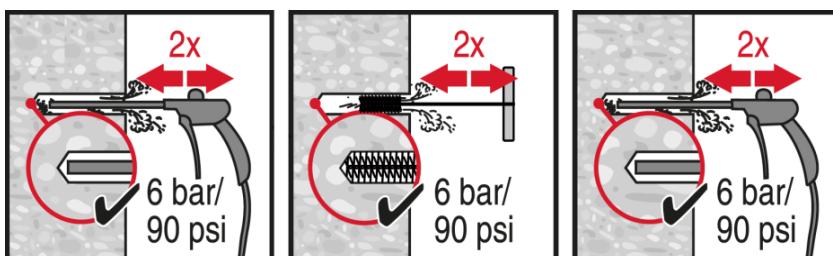
**Diamond Drilling + Roughening Tool (DD+RT)**
**Cleaning**

**Hammer drilling:**
**Manual cleaning (MC)**

for drill diameters  $d_0 \leq 20$  mm and drill hole depth  $h_0 \leq 10 \cdot d$ .

**Hammer drilling:**
**Compressed air cleaning (CAC)**

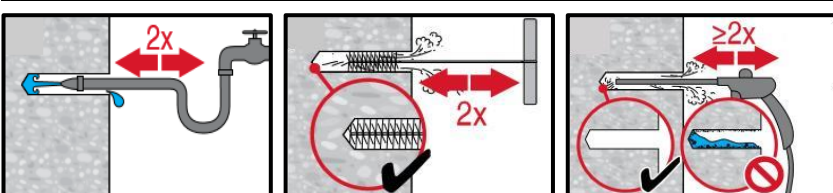
for all drill hole diameters  $d_0$  and drill hole depths  $h_0 \leq 20 \cdot d$ .

**Diamond cored holes with Hilti roughening tool:**

For all drill hole diameters  $d_0$  and drill hole depths  $h_0$ .



**Injection**

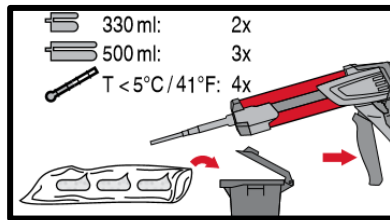
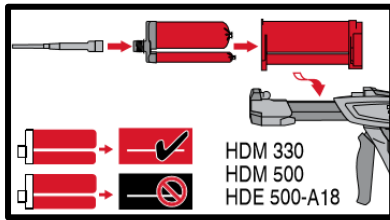

**Injection system preparation.**

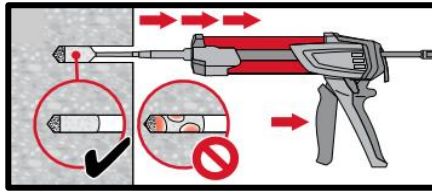
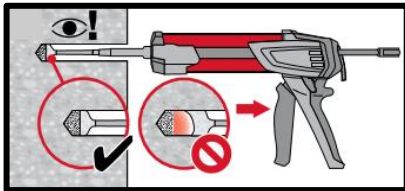

**Injection method for drill hole depth  $h_{ef} \leq 250$  mm.**

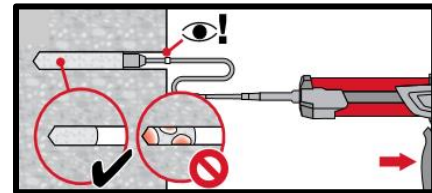
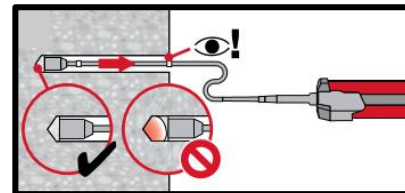

**Injection method for drill hole depth  $h_{ef} > 250$  mm.**

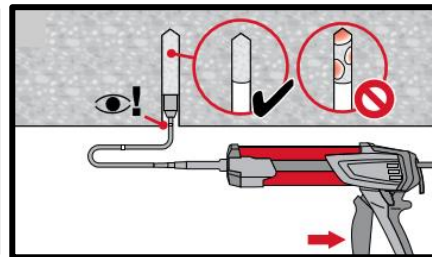
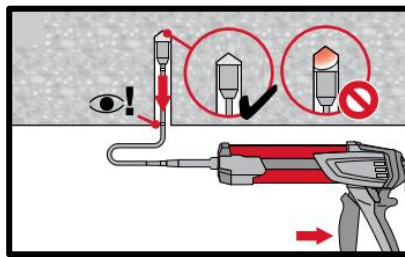

**Injection method for overhead application and/or installation with embedment depth  $> 250$  mm.**

**Setting the element**

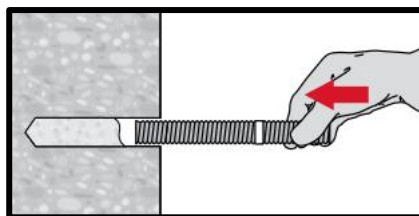

**Setting element, observe working time " $t_{work}$ ".**

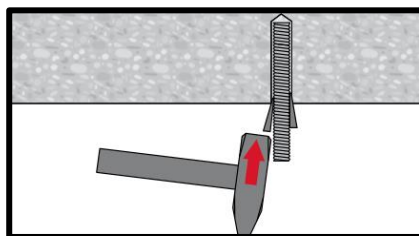

**Setting element for overhead applications, observe working time " $t_{work}$ ".**

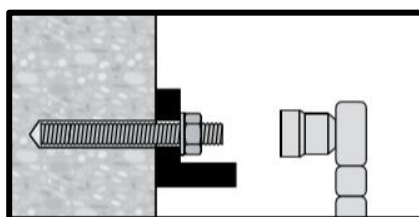

**Loading the anchor after required curing time  $t_{cure}$**



## Setting instructions for HIT-Z & HIT-Z(-D) rods

\*For detailed information on installation see instruction for use given with the package of the product.



### Safety regulations.

Review the Material Safety Data Sheet (MSDS) before use for proper and safe handling! Wear well-fitting protective goggles and protective gloves when working with Hilti HIT-HY 200 A (R)

### Drilling

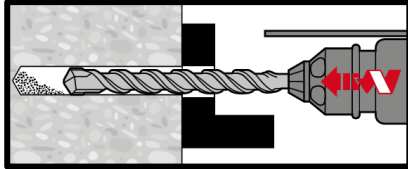

#### Hammer drilling: Through-setting

No cleaning required

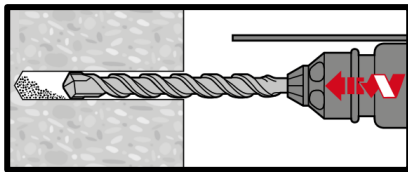

#### Hammer drilling: Pre-setting

No cleaning required

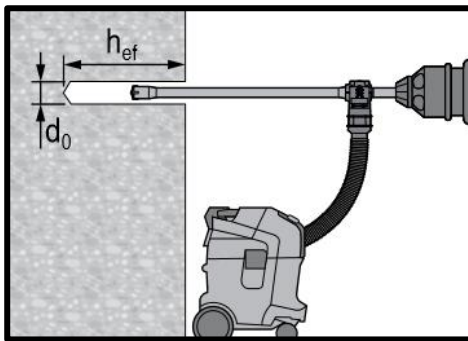

#### Hammer drilling with hollow drill bit: Through / pre-setting

No cleaning required

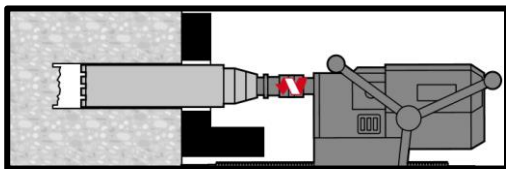

#### Diamond coring: Through-setting

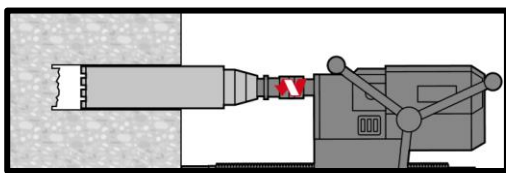

#### Diamond coring: Pre-setting

### Cleaning

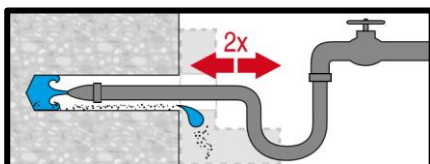

**Hole flushing** required for wet-drilled diamond cored holes.

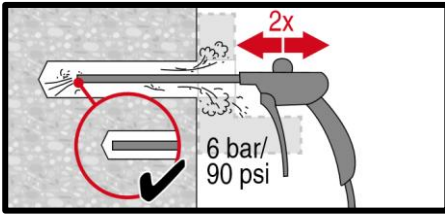

**Evacuation** required for wet-drilled diamond cored holes.

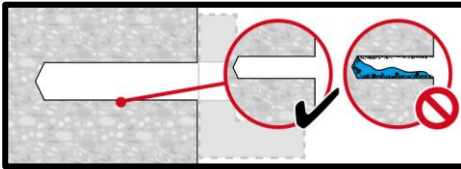

**Injection**

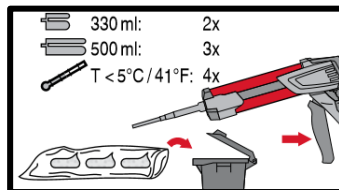
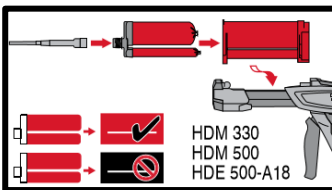

**Injection system preparation.**

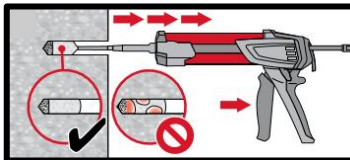
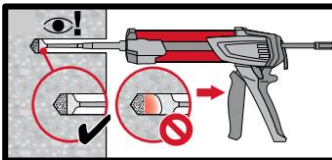

**Injection** of adhesive from the back of the drill hole without forming air voids.

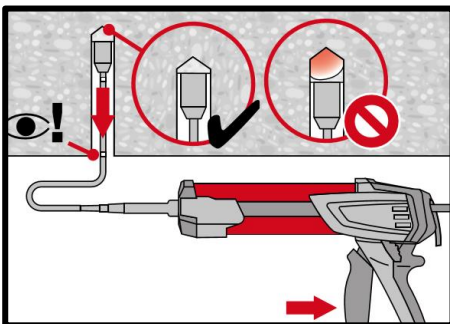

**Overhead installation** only with the aid of extensions and piston plugs.

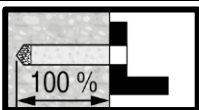

**Through-setting:**

Fill 100% of the drill hole.



**Pre-setting:**

Fill approx. 2/3 of the drill hole.

**Setting the element**

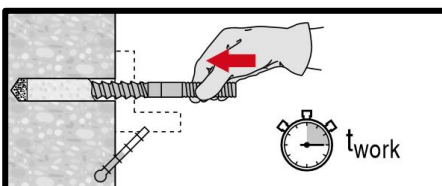

**Setting element** to the required embedment depth before working time "t<sub>work</sub>" has elapsed.

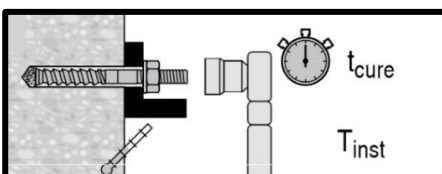

**Loading the anchor:** After required curing time t<sub>cure</sub>.

**Setting instructions for HAS-D rods**

\*For detailed information on installation see instruction for use given with the package of the product.

**Safety regulations.**

Review the Material Safety Data Sheet (MSDS) before use for proper and safe handling! Wear well-fitting protective goggles and protective gloves when working with Hilti HIT-HY 200 A (R)

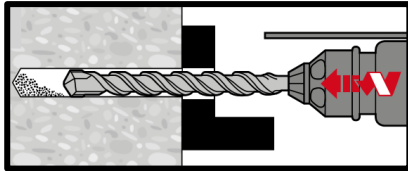
**Drilling**

**Hammer drilling: Through-setting**

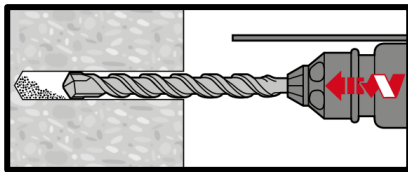

**Hammer drilling: Pre-setting**

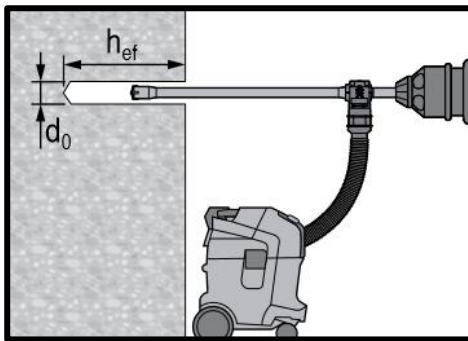

**Hammer drilling with hollow drill bit: Through / pre-setting**  
No cleaning required

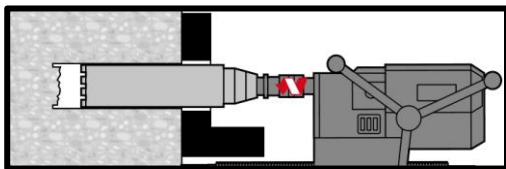

**Diamond coring: Through-setting**

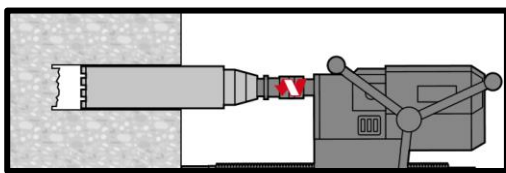

**Diamond coring: Pre-setting**

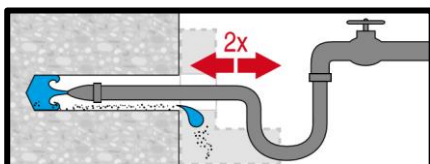
**Cleaning**

**Hole flushing** required for wet-drilled diamond cored holes.

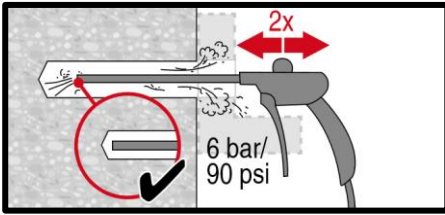

**Evacuation** required for wet-drilled diamond cored holes.

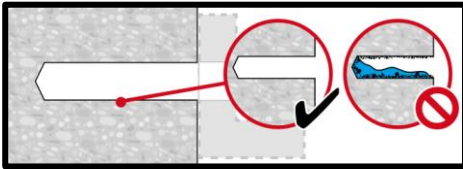

**Injection**

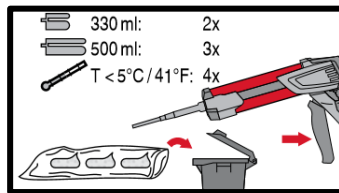
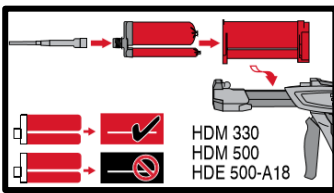

**Injection system preparation.**

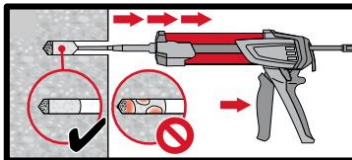
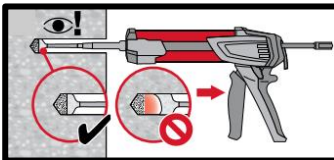

**Injection** of adhesive from the back of the drill hole without forming air voids.

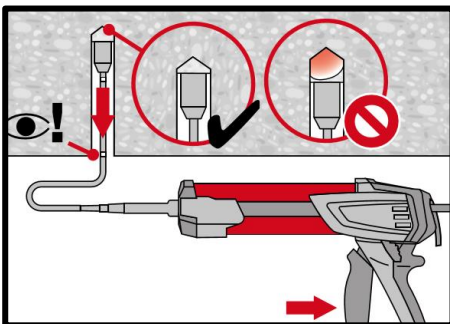

**Overhead installation** only with the aid of extensions and piston plugs.

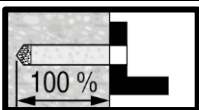

**Through-setting:**  
Fill 100% of the drill hole.



**Pre-setting:**  
Fill approx. 2/3 of the drill hole.

**Setting the element**

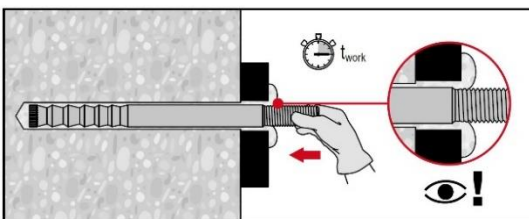

**Setting element** to the required embedment depth before working time "t<sub>work</sub>" has elapsed.

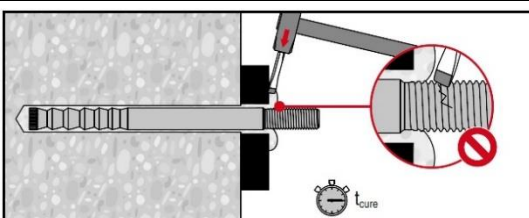

**Removing excess mortar:** After required curing time t<sub>cure</sub>.

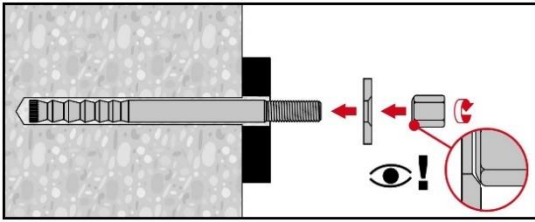
**Final assembly with sealing washer**

**Installation:** Orient the round part of the calotte nut to the sealing washer and install.

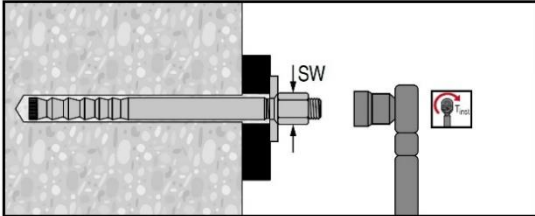

**Installation torque moment**

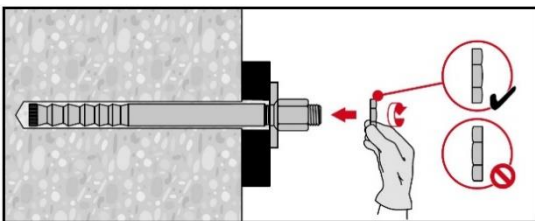

**Applying the lock nut:** Tighten with a  $\frac{1}{4}$  to  $\frac{1}{2}$  turn.

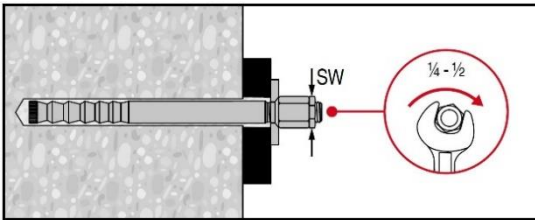

# HIT-HY 200 injection mortar

Anchor design (EN 1992-4) / Rebar elements / Concrete

## Injection mortar system



Hilti HIT - HY 200-A

330 ml foil pack  
(also available as  
500 ml foil pack)



Hilti HIT - HY 200-R

330 ml foil pack  
(also available as  
500 ml foil pack)



Rebar B500 B  
( $\phi 8$  -  $\phi 32$ )

## Benefits

- **SafeSet** technology: Simplified method of borehole preparation using either Hilti hollow drill bit for hammer drilling or Roughening tool for diamond cored applications
- ETA seismic approval C1
- Suitable for cracked and non-cracked concrete C 20/25 to C 50/60
- Suitable for dry and water saturated concrete
- High loading capacity, excellent handling
- Small edge distance and anchor spacing possible
- In service temperature range up to 120°C short term / 72°C long term
- Large diameter applications
- Two mortar versions: HY 200-R for slow cure applications and HY 200-A for fast cure applications

## Base material



Concrete  
(non-cracked)



Concrete  
(cracked)



Dry concrete

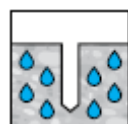

Wet concrete



Static/  
quasi-static



Seismic,  
ETA-C1



Fire  
resistance

## Load conditions

## Installation conditions

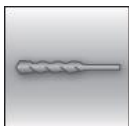

Hammer  
drilling



Diamond  
drilled holes<sup>a)</sup>

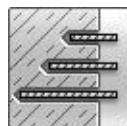

Variable  
embedment  
depth



Hilti **SafeSet**  
technology



Small edge  
distance and  
spacing



European  
Technical  
Assessment



CE  
conformity



PROFIS  
Engineering  
design  
Software

## Other informations

a) Diamond drilling only with Roughening Tool (RT).

## Approvals / certificates

Description	Product	Authority / Laboratory	No. / date of issue
European Technical Assessment <sup>a)</sup>	HY 200-A (Anchor)	DIBt, Berlin	ETA-11/0493 / 2019-08-30
European Technical Assessment <sup>a)</sup>	HY 200-R (Anchor)	DIBt, Berlin	ETA-12/0084 / 2019-08-28

a) All data given in this section according to ETA-11/0493 issue 2019-08-30 and to ETA-12/0084 issue 2019-08-28.



## Static and quasi-static loading (for a single anchor)

### All data in this section applies to

- Correct setting (See setting instruction)
- No edge distance and spacing influence
- Steel failure
- Base material thickness, as specified in the table
- Embedment depth, as specified in the table
- Anchor material, as specified in the tables
- Concrete C 20/25
- in-service temperate range I  
(min. base material temperature  $-40^{\circ}\text{C}$ , max. long term/short term base material temperature:  $+24^{\circ}\text{C}/40^{\circ}\text{C}$ )
- Short term loading. For long term loading please apply  $\psi_{\text{sus}} = 0.74$

### Embedment depth <sup>a)</sup> and base material thickness

Anchor- size		$\phi 8$	$\phi 10$	$\phi 12$	$\phi 14$	$\phi 16$	$\phi 20$	$\phi 25$	$\phi 26$	$\phi 28$	$\phi 30$	$\phi 32$
Embedment depth	$h_{\text{ef}}$ [mm]	80	90	110	125	125	170	210	240	270	270	300
Base material thickness	$h$ [mm]	110	120	145	165	165	220	275	305	340	345	380

a) The allowed range of embedment depth is shown in the setting details.

### Characteristic resistance

Anchor- size			$\phi 8$	$\phi 10$	$\phi 12$	$\phi 14$	$\phi 16$	$\phi 20$	$\phi 25$	$\phi 26$	$\phi 28$	$\phi 30$	$\phi 32$
<b>Non-cracked concrete</b>													
Tensile	Rebar B500B	$N_{\text{Rk}}$ [kN]	24,1	33,9	49,8	66,0	68,7	109,0	149,7	182,9	218,2	218,2	255,6
Shear	Rebar B500B	$V_{\text{Rk}}$ [kN]	14,0	22,0	31,0	42,0	55,0	86,0	135,0	146,0	169,0	194,0	221,0
<b>Cracked concrete</b>													
Tensile	Rebar B500B	$N_{\text{Rk}}$ [kN]	-	14,1	29,0	38,5	44,0	74,8	104,8	128,0	152,8	152,8	178,9
Shear	Rebar B500B	$V_{\text{Rk}}$ [kN]	-	22,0	31,0	42,0	55,0	86,0	135,0	146,0	169,0	194,0	221,0

### Design resistance

Anchor- size			$\phi 8$	$\phi 10$	$\phi 12$	$\phi 14$	$\phi 16$	$\phi 20$	$\phi 25$	$\phi 26$	$\phi 28$	$\phi 30$	$\phi 32$
<b>Non-cracked concrete</b>													
Tensile	Rebar B500B	$N_{\text{Rd}}$ [kN]	16,1	22,6	33,2	44,0	45,8	72,7	99,8	121,9	145,5	145,5	170,4
Shear	Rebar B500B	$V_{\text{Rd}}$ [kN]	9,3	14,7	20,7	28,0	36,7	57,3	90,0	97,3	112,7	129,3	147,3
<b>Cracked concrete</b>													
Tensile	Rebar B500B	$N_{\text{Rd}}$ [kN]	-	9,4	19,4	25,7	29,3	49,8	69,9	85,4	101,8	101,8	119,3
Shear	Rebar B500B	$V_{\text{Rd}}$ [kN]	-	14,7	20,7	28,0	36,7	57,3	90,0	97,3	112,7	129,3	147,3

### Recommended loads <sup>a)</sup>

Anchor- size			$\phi 8$	$\phi 10$	$\phi 12$	$\phi 14$	$\phi 16$	$\phi 20$	$\phi 25$	$\phi 26$	$\phi 28$	$\phi 30$	$\phi 32$
<b>Non-cracked concrete</b>													
Tensile	Rebar B500B	$N_{\text{Rec}}$ [kN]	11,5	16,1	23,7	31,4	32,7	51,9	71,3	87,1	103,9	103,9	121,7
Shear	Rebar B500B	$V_{\text{Rec}}$ [kN]	6,7	10,5	14,8	20,0	26,2	41,0	64,3	69,5	80,5	92,4	105,2
<b>Cracked concrete</b>													
Tensile	Rebar B500B	$N_{\text{Rec}}$ [kN]	-	6,7	13,8	18,3	20,9	35,6	49,9	61,0	72,7	72,7	85,2
Shear	Rebar B500B	$V_{\text{Rec}}$ [kN]	-	10,5	14,8	20,0	26,2	41,0	64,3	69,5	80,5	92,4	105,2

a) With overall partial safety factor for action  $\gamma = 1.4$ . The partial safety factors for action depend on the type of loading and shall be taken from national regulations.

### Seismic loading (for a single anchor)

#### All data in this section applies to:

- Correct setting (See setting)
- No edge distance and spacing influence
- Steel failure
- Minimum base material thickness
- Concrete C 20/25
- In-service temperate range I  
(min, base material temperature -40°C, max, long term/short term base material temperature: +24°C/40°C)
- $\alpha_{\text{gap}} = 1,0$

#### Embedment depth and base material thickness in case of seismic performance category C1

Anchor- size			φ8	φ10	φ12	φ14	φ16	φ20	φ25	φ26	φ28	φ30	φ32
Typical embedment depth	$h_{\text{ef}}$	[mm]	-	90	110	125	125	170	210	240	270	270	300
Base material thickness	$h$	[mm]	-	120	145	165	165	220	275	305	340	345	380

#### Characteristic resistance in case of seismic performance category C1

Anchor- size				φ8	φ10	φ12	φ14	φ16	φ20	φ25	φ26	φ28	φ30	φ32
Tensile	Rebar B500B	$N_{\text{Rk, seis}}$	[kN]	-	12,4	25,3	33,5	38,3	64,9	89,1	108,8	129,9	129,9	152,1
Shear	Rebar B500B	$V_{\text{Rk, seis}}$	[kN]	-	15,0	22,0	29,0	39,0	60,0	95,0	102,0	118,0	136,0	155,0

#### Design resistance in case of seismic performance category C1

Anchor- size				φ8	φ10	φ12	φ14	φ16	φ20	φ25	φ26	φ28	φ30	φ32
Tensile	Rebar B500B	$N_{\text{Rd, seis}}$	[kN]	-	8,3	16,9	22,4	25,6	43,4	59,4	72,6	86,6	86,6	101,4
Shear	Rebar B500B	$V_{\text{Rd, seis}}$	[kN]	-	10,0	14,7	19,3	26,0	40,0	63,3	68,0	78,7	90,7	103,3



## Materials

### Mechanical properties

Anchor size		φ8	φ10	φ12	φ14	φ16	φ20	φ25	φ26	φ28	φ30	φ32
Nominal tensile strength	$f_{uk}$ [N/mm <sup>2</sup> ]	550	550	550	550	550	550	550	550	550	550	550
Yield strength	$f_{yk}$ [N/mm <sup>2</sup> ]	500	500	500	500	500	500	500	500	500	500	500
Stressed cross-section	$A_s$ [mm <sup>2</sup> ]	50,3	78,5	113	154	201	314	491	531	616	707	804
Moment of resistance	$W$ [mm <sup>3</sup> ]	50,3	98,2	170	269	402	785	1534	1726	2155	2651	3217

### Material quality

Part	Material
Rebar EN 1992-1-1:2004 and AC:2010	Bars and de-coiled rods class B or C according to NDP or NCL of EN 1992-1-1/NA:2013

## Setting information

### Installation temperature range

- 10°C to + 40°C

### Service temperature range

Hilti HIT-HY 200 injection mortar may be applied in the temperature ranges given below, An elevated base material temperature may lead to a reduction of the design bond resistance,

Temperature range	Base material temperature	Maximum long term base material temperature	Maximum short term base material temperature
Temperature range I	-40 °C to + 40 °C	+ 24 °C	+ 40 °C
Temperature range II	-40 °C to + 80 °C	+ 50 °C	+ 80 °C
Temperature range III	-40 °C to + 120 °C	+ 72 °C	+ 120 °C

### Maximum short term base material temperature

Short term elevated base material temperatures are those that occur over brief intervals, e.g, as a result of diurnal cycling,

### Maximum long term base material temperature

Long term elevated base material temperatures are roughly constant over significant periods of time,

## Curing and working time

Temperature of the base material	HIT-HY 200-A		HIT-HY 200-R	
	Maximum working time	Minimum curing time	Maximum working time	minimum curing time
$T_{BM}$	$t_{work}$	$t_{cure}$	$t_{work}$	$t_{cure}$
- 10°C < $T_{BM}$ ≤ - 5°C	1,5 h	7 h	3 h	20 h
- 5°C < $T_{BM}$ ≤ 0°C	50 min	4 h	2 h	8 h
0°C < $T_{BM}$ ≤ 5°C	25 min	2 hour	1 h	4 h
5°C < $T_{BM}$ ≤ 10°C	15 min	75 min	40 min	2,5 h
10°C < $T_{BM}$ ≤ 20°C	7 min	45 min	15 min	1,5 h
20°C < $T_{BM}$ ≤ 30°C	4 min	30 min	9 min	1 h
30°C < $T_{BM}$ ≤ 40°C	3 min	30 min	6 min	1 h

**Setting details**

Anchor size		Ø8	Ø10	Ø12	Ø14	Ø16	Ø20	Ø25	Ø26	Ø28	Ø30	Ø32	
Nominal diameter of drill bit	$d_0$ [mm]	10 / 12 <sup>a)</sup>	12 / 14 <sup>a)</sup>	14 / 16 <sup>a)</sup>	18	20	25	32	32	35	37	40	
Effective anchorage depth (=drill hole depth) <sup>b)</sup>	$h_{ef,min} = h_0$ [mm]	60	60	70	75	80	90	100	104	112	120	128	
	$h_{ef,max} = h_0$ [mm]	160	200	240	280	320	400	500	520	560	600	640	
Minimum base material thickness	$h_{min}$ [mm]	$h_{ef} + 30 \text{ mm} \geq 100 \text{ mm}$			$h_{ef} + 2 d_0$								
Minimum spacing	$s_{min}$ [mm]	40	50	60	70	80	100	125	130	140	150	160	
Minimum edge distance	$c_{min}$ [mm]	40	45	45	50	50	65	70	75	75	80	80	
Critical spacing for splitting failure	$s_{cr,sp}$ [mm]	$2 c_{cr,sp}$											
Critical edge distance for splitting failure <sup>c)</sup>	$c_{cr,sp}$ [mm]	$1,0 \cdot h_{ef}$ for $h / h_{ef} \geq 2,0$											
		$4,6 h_{ef} - 1,8 h$ for $2,0 > h / h_{ef} > 1,3$											
		$2,26 h_{ef}$ for $h / h_{ef} \leq 1,3$											
Critical spacing for concrete cone failure	$s_{cr,N}$ [mm]	$2 c_{cr,N}$											
Critical edge distance for concrete cone failure	$c_{cr,N}$ [mm]	$1,5 h_{ef}$											

For spacing (edge distance) smaller than critical spacing (critical edge distance) the design loads have to be reduced,

- a) Both given values for drill bit diameter can be used.
- b)  $h_{ef,min} \leq h_{ef} \leq h_{ef,max}$  ( $h_{ef}$ : embedment depth).
- c)  $h$ : base material thickness ( $h \geq h_{min}$ ).

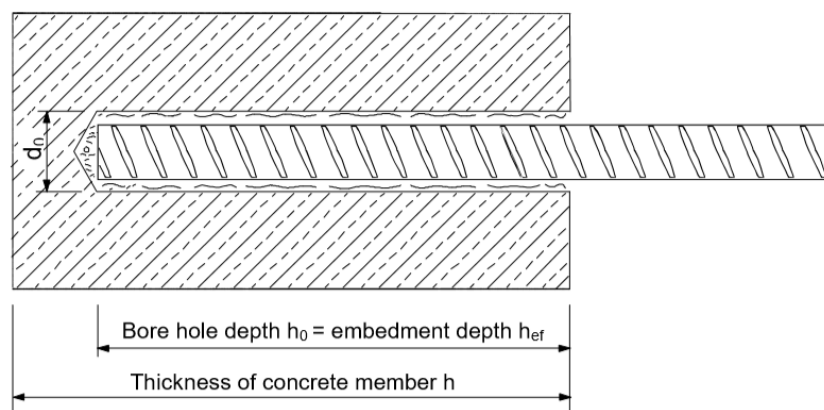
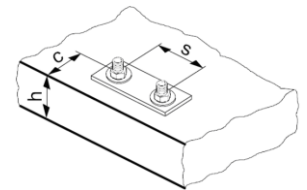

**Installation equipment**

Anchor size	φ8	φ10	φ12	φ14	φ16	φ20	φ25	φ26	φ28	φ30	φ32
Rotary hammer	TE 2 (-A) – TE 16 (-A)					TE 40 – TE 80					
Other tools	blow out pump ( $h_{ef} \leq 10 \cdot d$ , $d_0 \leq 20$ mm), Compressed air gun, Set of cleaning brushes, dispenser										

**Drilling and cleaning diameters**

Rebar	Drilling			Cleaning
	Hammer drill (HD)	Hollow Drill Bit (HDB)	Diamond coring with Roughening Tool (RT)	Brush HIT-RB
	d <sub>0</sub> [mm]			size [mm]
φ8	12 / 10 <sup>a)</sup>	12	-	12 / 10 <sup>a)</sup>
φ10	14 / 12 <sup>a)</sup>	14 / 12 <sup>a)</sup>	-	14 / 12 <sup>a)</sup>
φ12	16 / 14 <sup>a)</sup>	16 / 14 <sup>a)</sup>	-	16 / 14 <sup>a)</sup>
φ14	18	18	18	18
φ16	20	20	20	20
φ20	25	25	25	25
φ25	32	32	32	32
φ26	32	32	35	32
φ28	35	35	35	35
φ30	37	-	-	37
φ32	40	-	-	40

a) Both given values can be used.

**Associated components for the use of Hilti Roughening tool TE-YRT**

Diamond coring		Roughening tool TE-YRT	Wear gauge RTG...
d <sub>0</sub> [mm]		d <sub>0</sub> [mm]	size
Nominal	measured		
18	17,9 to 18,2	18	18
20	19,9 to 20,2	20	20
22	21,9 to 22,2	22	22
25	24,9 to 25,2	25	25
28	27,9 to 28,2	28	28
30	29,9 to 30,2	30	30
32	31,9 to 32,2	32	32
35	34,9 to 35,2	35	35

**Installation parameters for use of the Hilti Roughening tool TE-YRT**

h <sub>ef</sub> [mm]	Minimum roughening time t <sub>roughen</sub> [sec] (t <sub>roughen</sub> [sec] = h <sub>ef</sub> [mm] / 10)	Minimum blowing time t <sub>blowing</sub> [sec] (t <sub>blowing</sub> [sec] = t <sub>roughen</sub> [sec] + 20)
0 to 100	10	30
101 to 200	20	40
201 to 300	30	50
301 to 400	40	60
401 to 500	50	70
501 to 600	60	80

## Setting instructions

\*For detailed information on installation see instruction for use given with the package of the product,



### Safety regulations.

Review the Material Safety Data Sheet (MSDS) before use for proper and safe handling! Wear well-fitting protective goggles and protective gloves when working with Hilti HIT-HY 200.

## Drilling

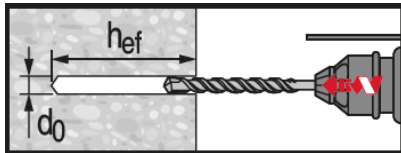

**Hammer drilled hole (HD)**

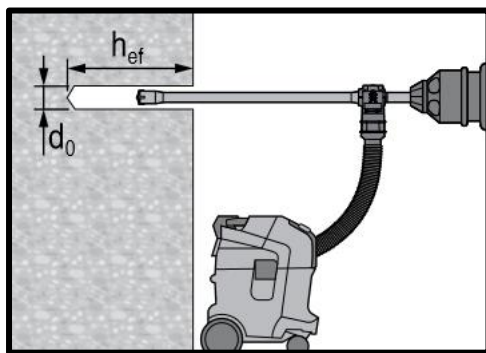

**Hammer drilled hole with Hollow Drilled Bit (HDB)**

No cleaning required

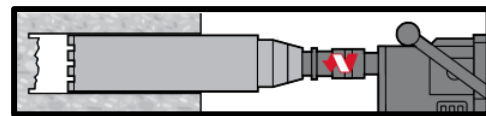

**Diamond Drilling + Roughening Tool (DD+RT)**

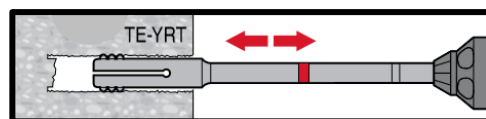

## Cleaning (Inadequate hole cleaning = poor load values.)

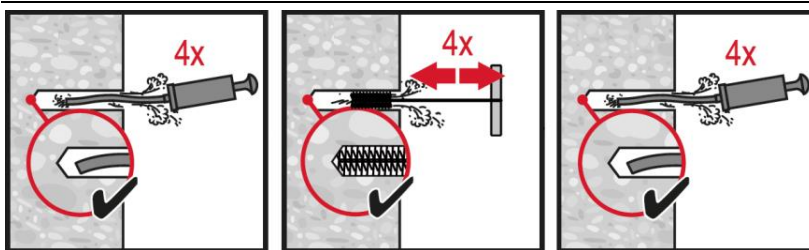

### Hammer drilling:

#### Manual cleaning (MC)

for drill diameters  $d_0 \leq 20$  mm and drill hole depth  $h_0 \leq 10 \cdot d$ .

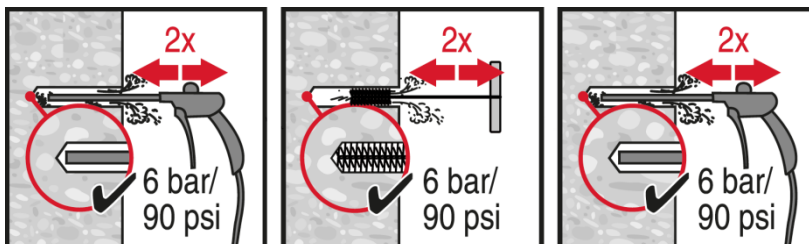

### Hammer drilling:

#### Compressed air cleaning (CAC)

for all drill hole diameters  $d_0$  and drill hole depths  $h_0 \leq 20 \cdot d$ .

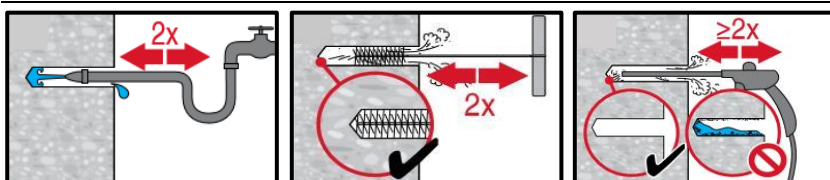

### Diamond cored holes with Hilti roughening tool:

For all drill hole diameters  $d_0$  and drill hole depths  $h_0$ .

**Injection system preparation**

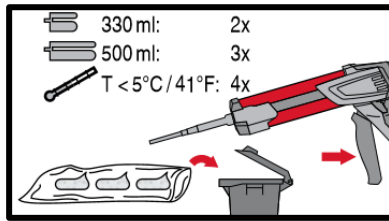
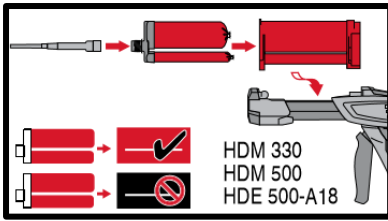

**Injection system preparation.**

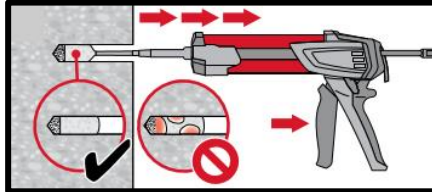
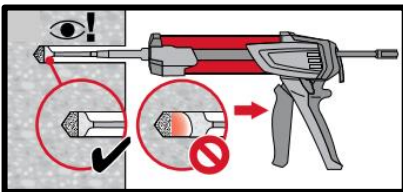

**Injection method for drill hole depth  $h_{ef} \leq 250$  mm.**

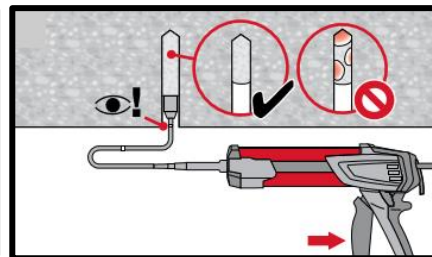
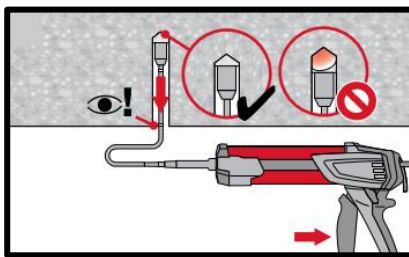

**Injection method for overhead application and/or installations with embedment depth  $h_{ef} \geq 250$  mm.**

**Setting the element**

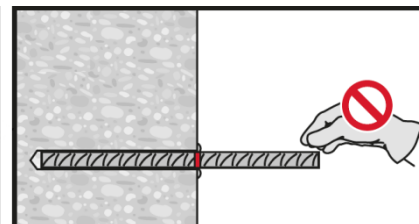
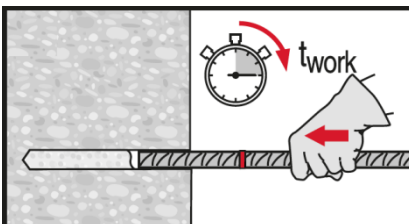

**Setting element, observe working time " $t_{work}$ ".**

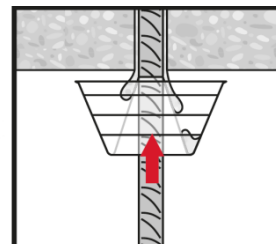
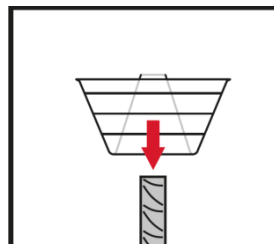
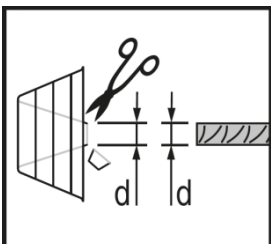

**Setting element for overhead applications, observe working time " $t_{work}$ ".**

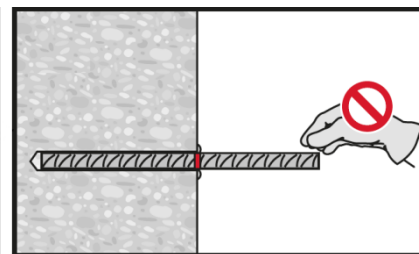
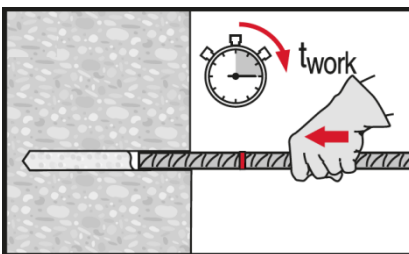

**Setting element, observe working time " $t_{work}$ ".**

# HIT-HY 200 injection mortar

Rebar design (EN 1992-1-1) / Rebar elements / Concrete

## Injection mortar system



Hilti HIT-HY 200-R  
330 ml foil pack  
(also available as  
500 ml foil pack)



Hilti HIT-HY 200-A  
330 ml foil pack  
(also available as  
500 ml foil pack)



Rebar  
( $\phi 8$  -  $\phi 32$ )

## Benefits

- **SafeSet** technology: Simplified method of borehole preparation using either Hilti hollow drill bit for hammer drilling or Roughening tool for diamond cored applications
- HY 200-R version is formulated for best handling and cure time specifically for rebar applications
- Approved for ETA seismic C1 approval for post-installed-rebar
- Suitable for concrete C 12/15 to C 50/60
- Suitable for dry and water saturated concrete
- For rebar diameters up to 32 mm
- Non corrosive to rebar elements
- Good load capacity at elevated temperatures
- Suitable for embedment length up to 1000 mm
- Suitable for applications down to -10 °C
- Two mortar versions: HY 200-A for slow cure applications and HY 200-R for fast cure applications

## Base material



Concrete  
(non-cracked)



Concrete  
(cracked)

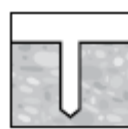

Dry concrete



Wet  
concrete

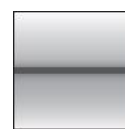

Static/  
quasi-static



Seismic<sup>a)</sup>



Fire resistance

## Load conditions

## Installation conditions

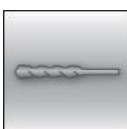

Hammer  
drilling



Diamond  
drilled holes<sup>b)</sup>



Hilti **SafeSet**  
technology

## Other informations



European  
Technical  
Assessment



CE  
conformity



PROFIS  
Engineering  
design  
Software

a) Seismic data only valid for HY 200-R.

b) Diamond drilling only with Roughening Tool (RT).

**Approvals / certificates**

Description	Product	Authority / Laboratory	No. / date of issue
European Technical Assessment <sup>a)</sup>	HY 200-A (Rebar)	DIBt, Berlin	ETA-11/0492 / 2014-06-26
European Technical Assessment <sup>a)</sup>	HY 200-R (Rebar)	DIBt, Berlin	ETA-12/0083 / 2019-06-21
Assessment (fire)	HY 200-A	CSTB, Marne la Vallée	Z-21.8-1948 / 2013-11-14
Assessment (fire)	HY 200-R	CSTB, Marne la Vallée	Z-21.8-1947 / 2014-07-22

a) All data given in this section according to ETA-11/0492, issue 2014-06-26 and ETA-12/0083, issue 2019-06-21.

**Static and quasi-static loading**
**Static design acc. to EN 1992-1-1**
**Design bond strength in N/mm<sup>2</sup> for good bond conditions**

All allowed drilling methods									
Rebar - size	Concrete class								
	C12/15	C16/20	C20/25	C25/30	C30/37	C35/45	C40/50	C45/55	C50/60
φ8 - φ32	1,6	2,0	2,3	2,7	3,0	3,4	3,7	4,0	4,3

For poor bond conditions multiply the values by 0,7. Values valid for non-cracked and cracked concrete.

**Minimum anchorage length and minimum lap length**

The minimum anchorage length  $\ell_{b,min}$  and the minimum lap length  $\ell_{0,min}$  according to EN 1992-1-1 shall be multiplied by relevant **Amplification factor  $\alpha_{lb}$**  in the table below.

**Amplification factor  $\alpha_{lb}$  for the min. anchorage length and min. lap length for**

All allowed hammer drilling methods									
Rebar - size	Concrete class								
	C12/15	C16/20	C20/25	C25/30	C30/37	C35/45	C40/50	C45/55	C50/60
φ8 - φ32	1,0								



**Anchorage length for characteristic steel strength  $f_{yk}=500 \text{ N/mm}^2$  for good conditions**

All allowed drilling methods								
Rebar-size	Concrete class	Yielding load [kN]	$l_{b,min}^{1)}$ [mm]	$l_{0,min}^{1)}$ [mm]	$l_{bd,y} (\alpha_2=1)^{2)}$ [mm]	$l_{bd,y} (\alpha_2=0.7)^{3)}$ [mm]	$l_{max}^{-10^\circ\text{C} \leq c_t^{4)} \leq 0^\circ\text{C}}$ [mm]	$l_{max}^{c_t^{4)} > 0^\circ\text{C}}$ [mm]
φ8	C20/25	21,9	113	200	378	265	700	1000
φ8	C50/60	21,9	100	200	202	142	700	1000
φ10	C20/25	34,1	142	200	473	331	700	1000
φ10	C50/60	34,1	100	200	253	177	700	1000
φ12	C20/25	49,2	170	200	567	397	700	1000
φ12	C50/60	49,2	120	200	303	212	700	1000
φ14	C20/25	66,9	198	210	662	463	700	1000
φ14	C50/60	66,9	140	210	354	248	700	1000
φ16	C20/25	87,4	227	240	756	529	700	1000
φ16	C50/60	87,4	160	240	404	283	700	1000
φ18	C20/25	110,6	255	270	851	595	700	1000
φ18	C50/60	110,6	180	270	455	319	700	1000
φ20	C20/25	136,6	284	300	945	662	700	1000
φ20	C50/60	136,6	200	300	506	354	700	1000
φ22	C20/25	165,3	312	330	1040	728	700	1000
φ22	C50/60	165,3	220	330	556	389	700	1000
φ24	C20/25	196,7	340	360	1134	794	700	1000
φ24	C50/60	196,7	240	360	607	425	700	1000
φ25	C20/25	213,4	354	375	1181	827	700	1000
φ25	C50/60	213,4	250	375	632	442	700	1000
φ26	C20/25	230,8	369	390	1229	860	700	1000
φ26	C50/60	230,8	260	390	657	460	700	1000
φ28	C20/25	267,7	397	420	1323	926	700	1000
φ28	C50/60	267,7	280	420	708	495	700	1000
φ30	C20/25	307,3	425	450	1418	992	700	1000
φ30	C50/60	307,3	300	450	758	531	700	1000
φ32	C20/25	349,7	454	480	1512	1059	700	1000
φ32	C50/60	349,7	320	480	809	566	700	1000

1) According to EC2: EN 1992-1-1:2004  $l_{b,min}$  (8.6) and  $l_{0,min}$  (8.11) are calculated for good bond conditions with characteristic yield strength  $f_{yk} = 500 \text{ N/mm}^2$ ,  $\gamma_M=1,15$  and  $\alpha_6 = 1,0$ .

2) Embedment depth for yield of the rebar and for  $c_d/\phi = 1$  (characteristic yield strength  $f_{yk} = 500 \text{ N/mm}^2$ ).

3) Embedment depth for yield of the rebar and for  $c_d/\phi = 3$  (characteristic yield strength  $f_{yk} = 500 \text{ N/mm}^2$ ).

4)  $c_t$ =concrete temperature.

**Seismic data**
**Seismic data according to ETA-12/0083 assessment**
**Seismic reduction factor  $k_{b,seis}$  for hammer drilling (HD) and (HDB) and compressed air drilling (CA)**

Rebar - size	Reduction factor $k_{b,seis}$							
	Concrete class							
	C16/20	C20/25	C25/30	C30/37	C35/45	C40/50	C45/55	C50/60
φ12 - φ18	1,0				0,90	0,82	0,76	0,71
φ20 - φ30	1,0				0,92			0,86
φ32	1,0							

For poor bond conditions multiply the values 0,7.



Design values for the ultimate bond resistance  $f_{bd,seis}$  <sup>1)</sup> in N/mm<sup>2</sup> for seismic loading for hammer drilling (HD) and (HDB) and compressed air drilling (CA)

Rebar - size	Bond resistance $f_{bd,seis}$							
	Concrete class							
	C16/20	C20/25	C25/30	C30/37	C35/45	C40/50	C45/55	C50/60
$\phi 12 - \phi 18$	2,0	2,3	2,7	3,0				
$\phi 20 - \phi 30$	2,0	2,3	2,7	3,0	3,4	3,7		
$\phi 32$	2,0	2,3	2,7	3,0	3,4	3,7	4,0	4,3

1) According to EN 1992-1-1:2004 for good bond conditions. For all other bond conditions multiply the values by 0.7.

## Fire resistance

### a) Anchoring application

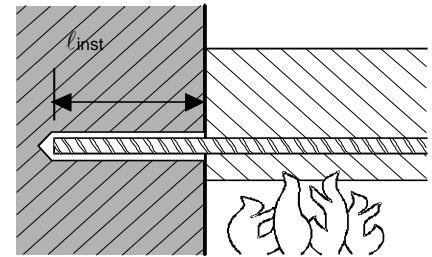

Maximum force ( $F_{s,T,max}$ ) in rebar in conjunction with HIT-HY 200 as a function of embedment depth ( $l_{inst}$ ) for the fire resistance classes R30 to R180 according to EC2.

Rebar-size	$F_{s,T,max}$ [kN]	$l_{inst}$ [mm]	Fire resistance of bar [kN]						
			R30	R60	R90	R120	R180		
$\phi 8$	16,19	80	3,0	0,7	0,2	0,0	0,0		
		120	7,0	2,2	1,3	0,7	0,2		
		170	16,2	16,2	16,2	10,2	9,2	4,0	1,7
		210				11,0	7,5		
		230				14,5	10,9		
		250				16,2	14,5		
		300				16,2	16,2		
$\phi 10$	25,29	100	6,1	2,0	1,0	0,4	0,0		
		150	19,3	9,3	7,1	2,2	1,0		
		190	25,3	25,3	25,3	18,0	15,9	9,3	4,9
		230				24,7	18,1	13,7	
		260				24,7	20,3		
		280				25,3	24,7		
		320				25,3	25,3		
$\phi 12$	36,42	120	15,3	6,0	1,9	1,1	0,3		
		180	31,0	19,0	17,8	8,5	7,0		

Maximum force ( $F_{s,T,max}$ ) in rebar in conjunction with HIT-HY 200 as a function of embedment depth ( $l_{inst}$ ) for the fire resistance classes F30 to F180 according to EC2

$\phi 12$	36,42	220	36,4	36,4	36,4	29,6	27,0	19,1	13,8
		260				29,7	24,4		
		280				35,0	29,6		
		300				36,4	34,9		
		340					36,4		
$\phi 14$	49,58	140	24,0	9,9	6,9	2,6	1,0		
		210	45,0	31,4	28,5	25,7	13,0		
		240	49,6	49,6	40,6	37,7	32,8	22,3	
		280			49,6	49,6	40,7	34,6	

		300				44,7	40,7	
		330				49,6	48,1	
		360					49,6	
<b>φ16</b>	<b>64,75</b>	160	34,5	18,4	14,9	4,4	2,3	
		240	62,6	46,4	43,0	37,7	25,5	
		260	64,8	53,5	50,0	44,7	32,5	
		300		64,8	57,0	51,7	49,6	
		330			61,3	57,2		
		360	64,8	64,8	64,8	64,8	62,7	
		400				64,8	64,8	
<b>φ20</b>	<b>101,18</b>	200	60,7	40,0	36,3	29,3	14,3	
		250	78,3	62,5	58,3	51,3	36,3	
		310	101,2	88,9	84,6	77,6	62,6	
		350		101,2	101,2	101,2	94,2	80,2
		370					101,2	83,5
		390	101,2	101,2	101,2	101,2	97,8	
		430				101,2	101,2	
<b>φ25</b>	<b>158,09</b>	250	97,9	78,1	72,6	64,7	45,3	
		280	126,5	94,6	89,4	81,2	61,8	
		370	158,1	144,0	127,9	119,7	111,2	
		410		158,1	158,1	158,1	141,8	123,2
		430					150,0	144,2
		450	158,1	158,1	158,1	150,0	155,2	
		500				158,1	158,1	
<b>φ32</b>	<b>158,09</b>	250	97,9	78,1	72,6	64,7	45,3	
		280	126,5	94,6	89,4	81,2	61,8	
		370	158,1	144,0	127,9	119,7	111,2	
		410		158,1	158,1	158,1	141,8	123,2
		430					150,0	144,2
		450	158,1	158,1	158,1	150,0	155,2	
		500				158,1	158,1	

 Characteristic yield strength  $f_{yk} = 500 \text{ N/mm}^2$ 

Steel failure

## b) Overlap joint application

Max. bond stress,  $f_{bd,FIRE}$ , depending on actual clear concrete cover for classifying the fire resistance.

It must be verified that the actual force in the bar during a fire,  $F_{s,T}$ , can be taken up by the bar connection of the selected length,  $l_{inst}$ . Note: Cold design for ULS is mandatory.

$$F_{s,T} \leq (l_{inst} - c_f) \cdot \phi \cdot \pi \cdot f_{bd,FIRE} \quad \text{where: } (l_{inst} - c_f) \geq l_s;$$

$l_s$  = lap length

$\phi$  = nominal diameter of bar

$l_{inst} - c_f$  = selected overlap joint length; this must be at least  $l_s$ ,

but may not be assumed to be more than  $80 \phi$

$f_{bd,FIRE}$  = bond stress when exposed to fire

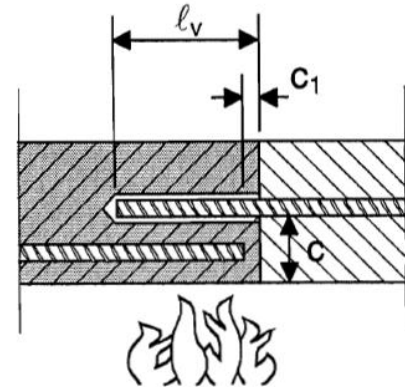

**Critical temperature-dependent bond stress,  $\tau_c$ , concerning “overlap joint” for Hilti HIT-HY 200 injection adhesive in relation to fire resistance class and required minimum concrete coverage c.**

Clear concrete cover c [mm]	Max. bond stress, $\tau_c$ [N/mm <sup>2</sup> ]						
	R30	R60	R90	R120	R180		
30	0,6	0,3	-	-	-		
35	0,7	0,3					
40	0,9	0,4	0,2				
45	1,0	0,4	0,2				
50	1,2	0,5	0,3				
55	1,5	0,6	0,3	0,2	-		
60	1,8	0,8	0,4	0,3			
65	2,2	0,9	0,5	0,3			
70		1,0	0,5	0,3			
75		1,2	0,6	0,4		0,2	
80		1,5	0,7	0,5		0,3	
85		1,7	0,8	0,5		0,3	
90		2,0	1,0	0,6		0,3	
95		2,2	2,2	1,1		0,7	0,4
100				1,3		0,8	0,4
105				1,5	0,9	0,5	
110				1,7	1,1	0,5	
115	2,0			1,2	0,6		
120	2,2	2,2	2,2	1,4	0,6		
125				1,6	0,7		
130				1,9	0,8		
135				2,1	0,9		
200					2,3		

## Materials

### Material quality

Part	Material
Rebar EN 1992-1-1	Bars and de-coiled rods class B or C with $f_{yk}$ and $k$ according to NDP or NCL of EN 1992-1-1 $f_{uk} = f_{tk} = k \cdot f_{yk}$

### Fitness for use

Some creep tests have been conducted in accordance with ETAG guideline 001 part 5 and TR 023 in the following conditions: **in dry environment at 50 °C during 90 days.**

These tests show an excellent behaviour of the post-installed connection made with HIT-HY 200: low displacements with long term stability, failure load after exposure above reference load.

### Resistance to chemical substances

Chemical	Resistance	Chemical	Resistance
Air	+	Gasoline	+
Acetic acid 10%	+	Glycole	o
Acetone	o	Hydrogen peroxide 10%	o
Ammonia 5%	+	Lactic acid 10%	+
Benzyl alcohol	-	Machinery oil	+
Chloric acid 10%	o	Methylethylketon	o
Chlorinated lime 10%	+	Nitric acid 10%	o
Citric acid 10%	+	Phosphoric acid 10%	+
Concrete plasticizer	+	Potassium Hydroxide pH 13,2	+
De-icing salt (Calcium chloride)	+	Sea water	+
Demineralized water	+	Sewage sludge	+
Diesel fuel	+	Sodium carbonate 10%	+
Drilling dust suspension pH 13,2	+	Sodium hypochlorite 2%	+
Ethanol 96%	-	Sulfuric acid 10%	+
Ethylacetate	-	Sulfuric acid 30%	+
Formic acid 10%	+	Toluene	o
Formwork oil	+	Xylene	o

- + resistant
- o resistant in short term (max. 48h) contact
- not resistant

### Electrical Conductivity

HIT-HY 200 in the hardened state **is not conductive electrically**. Its electric resistivity is  $15,5 \cdot 10^9 \Omega \cdot \text{cm}$  (DIN IEC 93 – 12.93). It is adapted well to realize electrically insulating anchoring (ex: railway applications, subway).

## Setting information

### Installation temperature range

-10°C to +40°C

### Service temperature range

Hilti HIT-HY 200 injection mortar may be applied in the temperature ranges given below. An elevated base material temperature may lead to a reduction of the design bond resistance.

Temperature range	Base material temperature	Maximum long term base material temperature	Maximum short term base material temperature
Temperature range I	-40 °C to +80 °C	+50 °C	+80 °C

### Maximum short term base material temperature

Short-term elevated base material temperatures are those that occur over brief intervals, e.g. as a result of diurnal cycling.

### Maximum long term base material temperature

Long-term elevated base material temperatures are roughly constant over significant periods of time.

### Curing and working time

Temperature of the base material	HIT-HY 200-A		HIT-HY 200-R	
	Maximum working time	Minimum curing time	Maximum working time	Minimum curing time
$T_{BM}$	$t_{work}$	$t_{cure}$	$t_{work}$	$t_{cure}$
$-10^{\circ}\text{C} < T_{BM} \leq -5^{\circ}\text{C}$	1,5 h	7 h	3 h	20 h
$-5^{\circ}\text{C} < T_{BM} \leq 0^{\circ}\text{C}$	50 min	4 h	2 h	8 h
$0^{\circ}\text{C} < T_{BM} \leq 5^{\circ}\text{C}$	25 min	2 hour	1 h	4 h
$5^{\circ}\text{C} < T_{BM} \leq 10^{\circ}\text{C}$	15 min	75 min	40 min	2,5 h
$10^{\circ}\text{C} < T_{BM} \leq 20^{\circ}\text{C}$	7 min	45 min	15 min	1,5 h
$20^{\circ}\text{C} < T_{BM} \leq 30^{\circ}\text{C}$	4 min	30 min	9 min	1 h
$30^{\circ}\text{C} < T_{BM} \leq 40^{\circ}\text{C}$	3 min	30 min	6 min	1 h

**Setting information**
**Installation equipment**

Rebar – size	φ8 - φ16	φ18 - φ32
Rotary hammer	TE 2 (-A)– TE 40(-A)	TE40 – TE80
Other tools	Blow out pump ( $h_{ef} \leq 10 \cdot d$ )	-
	Compressed air gun <sup>a)</sup> Set of cleaning brushes <sup>b)</sup> , dispenser, piston plug	



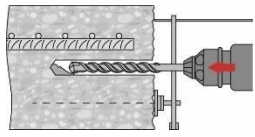

a) Compressed air gun with extension hose for all drill holes deeper than 250 mm (for φ 8 to φ 12) or deeper than  $20 \cdot \phi$  (for φ > 12 mm).

b) Automatic brushing with round brush for all drill holes deeper than 250 mm (for φ 8 to φ 12) or deeper than  $20 \cdot \phi$  (for φ > 12 mm).

**Minimum concrete cover  $c_{min}$  of the post-installed rebar**

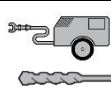
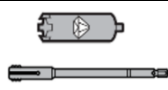

Drilling method	Bar diameter [mm]	Minimum concrete cover $c_{min}$ [mm]		
		Without drilling aid	With drilling aid	
Hammer drilling (HD) and (HDB)	$\phi < 25$	$30 + 0,06 \cdot l_v \geq 2 \cdot \phi$	$30 + 0,02 \cdot l_v \geq 2 \cdot \phi$	
	$\phi \geq 25$	$40 + 0,06 \cdot l_v \geq 2 \cdot \phi$	$40 + 0,02 \cdot l_v \geq 2 \cdot \phi$	
Compressed air drilling (CA)	$\phi < 25$	$50 + 0,08 \cdot l_v$	$50 + 0,02 \cdot l_v$	
	$\phi \geq 25$	$60 + 0,08 \cdot l_v \geq 2 \cdot \phi$	$60 + 0,02 \cdot l_v \geq 2 \cdot \phi$	
Diamond coring with roughening with Hilti Roughening tool TE-YRT (RT)	$\phi < 25$	$30 + 0,06 \cdot l_v \geq 2 \cdot \phi$	$30 + 0,02 \cdot l_v \geq 2 \cdot \phi$	
	$\phi \geq 25$	$40 + 0,06 \cdot l_v \geq 2 \cdot \phi$	$40 + 0,02 \cdot l_v \geq 2 \cdot \phi$	

**Drilling and cleaning diameters**

Rebar [mm]	Drilling				Cleaning	
	Hammer drill (HD)	Hollow Drill Bit (HDB) <sup>b)</sup>	Compressed air drill (CA)	Diamond coring with roughening tool (RT)	Brush HIT-RB	Air nozzle HIT-RB
	$d_0$ [mm]				size [mm]	
						
φ8	12 / 10 <sup>a)</sup>	12	-	-	12 / 10 <sup>a)</sup>	12 / 10 <sup>a)</sup>
φ10	14 / 12 <sup>a)</sup>	14 / 12 <sup>a)</sup>	-	-	14 / 12 <sup>a)</sup>	14 / 12 <sup>a)</sup>
φ12	16 / 14 <sup>a)</sup>	16 / 14 <sup>a)</sup>	-	-	16 / 14 <sup>a)</sup>	16 / 14 <sup>a)</sup>
	-	-	17	-	18	16
φ14	18	18	17	18	18	18
φ16	20	20	-	-	20	20
	-	-	20	20	22	20
φ18	22	22	22	22	22	22
φ20	25	25	-	-	25	25
	-	-	26	25	28	25
φ22	28	28	28	28	28	28
φ24	32	32	32	32	32	32
φ25	32	32	32	32	32	
φ26	35	-	35	35	35	
φ28	35	-	35	35	35	
φ30	-	-	35	-	35	
	37	-	-	-	37	
φ32	40	-	40	-	40	

a) Maximum installation length  $l=250$  mm.

**Associated components for the use of Hilti Roughening tool TE-YRT**

Diamond coring		Roughening tool TE-YRT	Wear gauge RTG...
			
d <sub>0</sub> [mm]		d <sub>0</sub> [mm]	size
Nominal	measured		
18	17,9 to 18,2	18	18
20	19,9 to 20,2	20	20
22	21,9 to 22,2	22	22
25	24,9 to 25,2	25	25
28	27,9 to 28,2	28	28
30	29,9 to 30,2	30	30
32	31,9 to 32,2	32	32
35	34,9 to 35,2	35	35

**Installation parameters for use of the Hilti Roughening tool TE-YRT**

h <sub>ef</sub> [mm]	Minimum roughening time t <sub>roughen</sub> [sec] (t <sub>roughen</sub> [sec] = h <sub>ef</sub> [mm] / 10)	Minimum blowing time t <sub>blowing</sub> [sec] (t <sub>blowing</sub> [sec] = t <sub>roughen</sub> [sec] + 20)
0 to 100	10	30
101 to 200	20	40
201 to 300	30	50
301 to 400	40	60
401 to 500	50	70
501 to 600	60	80

**Dispensers and corresponding maximum embedment depth  $l_{v,max}$** 

Rebar	Dispenser	
	HDM 330, HDM 500, HDE 500	HDE 500
	Concrete temp. $\geq -10^{\circ}\text{C}$	Concrete temp. $\geq 0^{\circ}\text{C}$
	$l_{v,max}$ [mm]	$l_{v,max}$ [mm]
$\phi 8 - \phi 32$	700	1000

## Setting instructions

\*For detailed information on installation see instruction for use given with the package of the product.



### Safety regulations.

Review the Material Safety Data Sheet (MSDS) before use for proper and safe handling! Wear well-fitting protective goggles and protective gloves when working with Hilti HIT-HY 200.

## Drilling

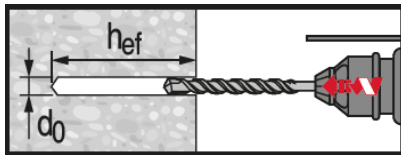

**Hammer drilled hole (HD)**

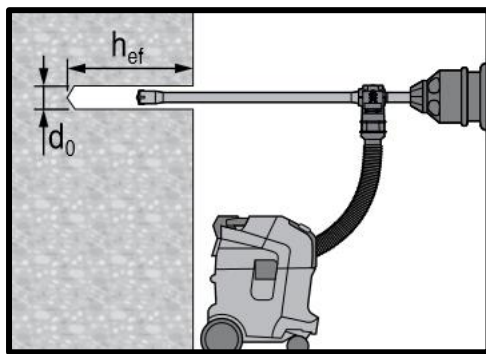

**Hammer drilled hole with Hollow Drilled Bit (HDB)**

No cleaning required

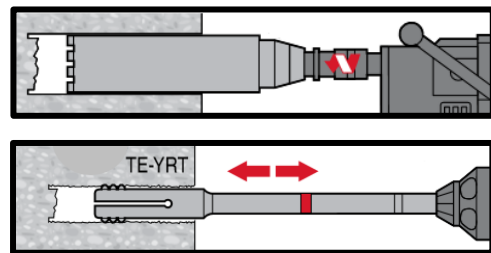

**Diamond Drilling + Roughening Tool (DD+RT)**

## Cleaning

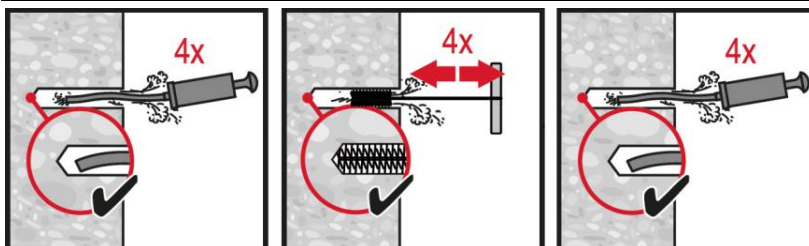

### Hammer drilling:

#### Manual cleaning (MC)

for drill diameters  $d_0 \leq 20$  mm and drill hole depth  $h_0 \leq 10 \cdot d$ .

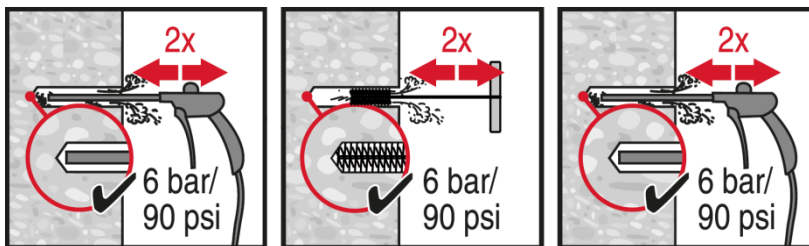

### Hammer drilling:

#### Compressed air cleaning (CAC)

for all drill hole diameters  $d_0$  and drill hole depths  $h_0 \leq 20 \cdot d$ .

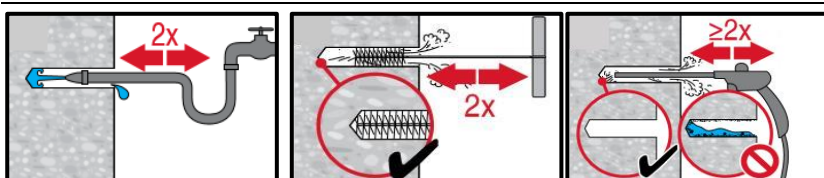

### Diamond cored holes with Hilti roughening tool:

For all drill hole diameters  $d_0$  and drill hole depths  $h_0$ .



**Injection system preparation**

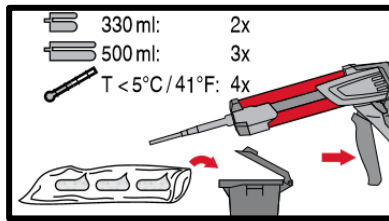
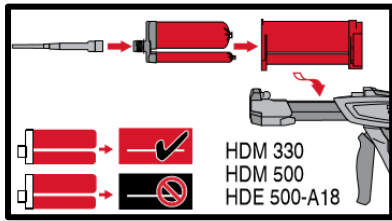

**Injection system preparation.**

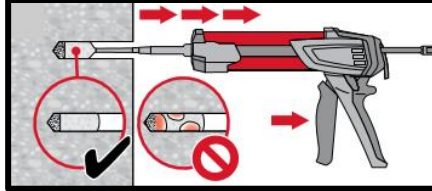
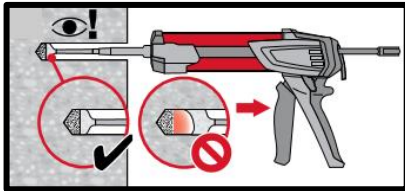

**Injection method for drill hole depth**  
 $h_{ef} \leq 250 \text{ mm.}$

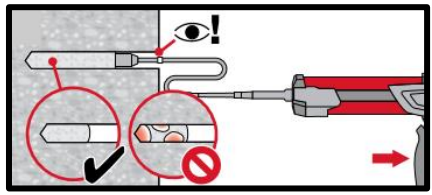
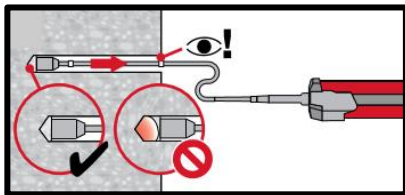

**Injection method for drill hole depth**  
 $h_{ef} > 250 \text{ mm.}$

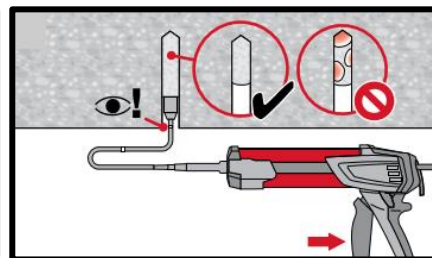
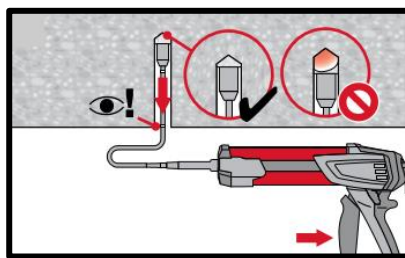

**Injection method for overhead**  
**application.**

**Setting the element**

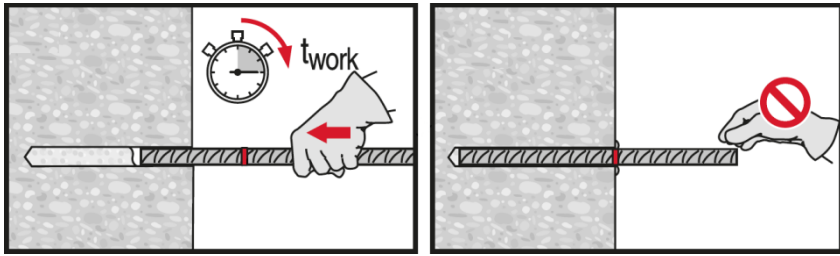

**Setting element**, observe working time "t<sub>work</sub>".

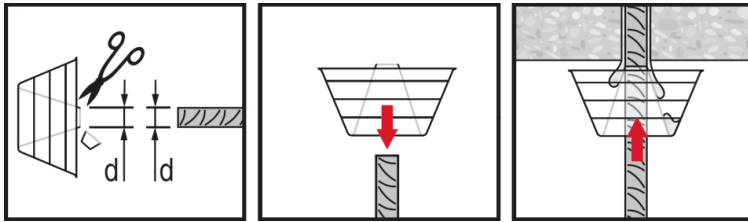

**Setting element** for overhead applications, observe working time "t<sub>work</sub>".

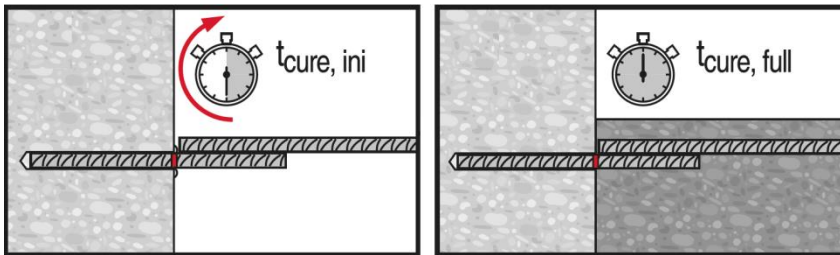
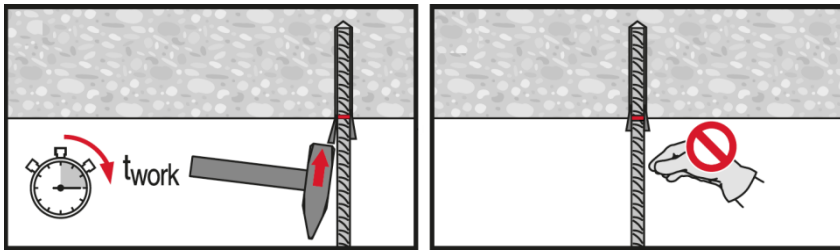

Apply full load only after curing time "t<sub>cure</sub>".

### 2.1.3 HIT-RE 500 V4

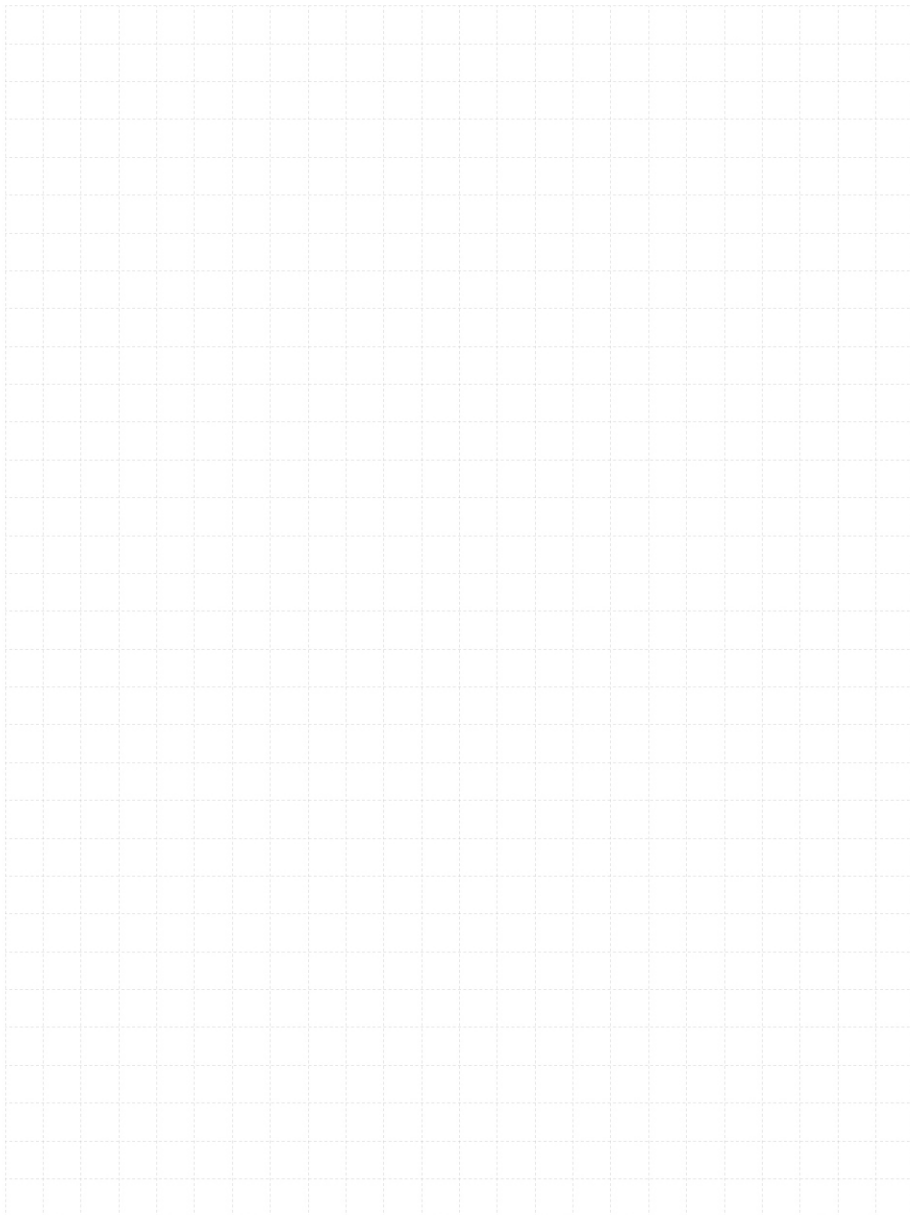

# HIT-RE 500 V4 injection mortar

## Anchor design (EN 1992-4) / Rods and Sleeves / Concrete

### Injection mortar system



Foil pack: HIT-RE 500 V4  
(available in 330, 500 and 1400 ml cartridges)



Anchor rod:  
HAS-U (HDG, A4, HCR)  
HAS-U  
HAS-U A4  
HAS-U HCR  
AM 8.8 (HDG)  
(M8-M39)



Internally threaded sleeve:  
HIS-N  
HIS-RN  
(M8-M20)

### Benefits

- **SafeSet** technology: Simplified method of borehole preparation using either Hilti hollow drill bit for hammer drilling or Roughening tool for diamond cored applications
- Suitable for non-cracked and cracked concrete C 20/25 to C 50/60
- High loading capacity
- Suitable for dry and water saturated concrete
- Hilti Technical Data for under water application
- ETA Data for 100y working life
- High corrosion resistance
- Long working time at elevated temperatures
- Cures down to -5 °C
- Odourless epoxy

### Base material



Concrete (non-cracked)



Concrete (cracked)

### Installation conditions

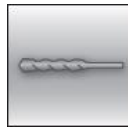

Hammer drilled holes



Diamond drilled holes



Hilti **SafeSet** technology

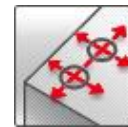

Small edge distance and spacing

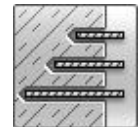

Variable embedment depth

### Load conditions

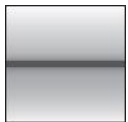

Static/  
quasi-static



Seismic,  
ETA-C1, C2

**100**  
YEARS

Working life  
100 years,  
ETA



European  
Technical  
Assessment



CE conformity

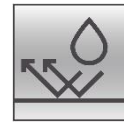

Corrosion  
resistance



High  
corrosion  
resistance <sup>1)</sup>



PROFIS  
Engineering  
design  
Software

### Other information

<sup>1)</sup> High Corrosion Resistant (HCR) rods available only for HAS-U.

### Approvals / certificates

Description	Authority / Laboratory	No. / date of issue
European Technical Assessment <sup>a)</sup>	CSTB	ETA-20/0541 / 2021-09-04
Engineering Judgement (120-years working life based on EAD 330499-01-0601)	BERGMEISTER, Vienna	No.: 10/2021
Shockproof fastenings in civil defence installations	Federal Office for Civil Protection, Bern	BZS D 21-602/ 2021-10-25

<sup>a)</sup> All data given in this section according to ETA-20/0541, issue 2021-09-04 (if not stated otherwise).

**Static and quasi-static resistance (for a single anchor) – Working life 50 years**
**All data in this section applies to:**

- Correct setting (see setting instruction)
- No edge distance and spacing influence
- Steel failure
- HAS-U anchor rod with strength class 5.8 and 8.8, AM anchor rod with strength class 8.8, HIS-N internally threaded insert with screw 8.8
- Base material thickness and embedment depth, as specified in the table
- Concrete C 20/25
- In-service temperature range I: -40 °C to +40 °C  
(min. base material temperature -40 °C, max. long/short term base material temperature: +24 °C/40 °C)
- Short term loading. For long term loading apply  $\psi_{\text{sus}}$  acc. to EN 1992-4  
Hammer drilled holes, hammer drilled holes with hollow drill bit and diamond cored holes with Hilti roughening tool:  $\psi_{\text{sus}}^0 = 0,88$ ; diamond cored holes:  $\psi_{\text{sus}}^0 = 0,89$

**Embedment depth<sup>a)</sup> and base material thickness**

Anchor size		ETA-20/0541, issued 2021-09-04								Hilti tech. data		
		M8	M10	M12	M16	M20	M24	M27	M30	M33	M36	M39
<b>HAS-U</b>												
Effective anchorage depth	$h_{\text{ef}}$ [mm]	80	90	110	125	170	210	240	270	300	330	360
Base material thickness	$h$ [mm]	110	120	140	161	214	266	300	340	374	410	444
<b>HIS-N</b>												
Effective anchorage depth	$h_{\text{ef}}$ [mm]	90	110	125	170	205	-	-	-	-	-	-
Base material thickness	$h$ [mm]	120	150	170	230	270	-	-	-	-	-	-

<sup>a)</sup> The allowed range of embedment depth is shown in the setting details.

**For hammer drilled holes, hammer drilled holes with hollow drill bit<sup>1)</sup> and diamond cored with Hilti roughening tool TE-YRT<sup>2)</sup>:**
**Characteristic resistance**

Anchor size		ETA-20/0541, issued 2021-09-04								Hilti tech. data			
		M8	M10	M12	M16	M20	M24	M27	M30	M33	M36	M39	
<b>Non-cracked concrete</b>													
Tension	HAS-U 5.8	$N_{\text{Rk}}$ [kN]	18,3	29,0	42,2	68,8	109,0	149,7	182,9	218,2	255,6	294,9	336,0
	HAS-U 8.8, AM 8.8		29,3	42,0	56,8	68,8	109,0	149,7	182,9	218,2	255,6	294,9	336,0
	HAS-U A4		25,6	40,6	56,8	68,8	109,0	149,7	182,9	218,2	255,6	294,9	336,0
	HAS-U HCR		29,3	42,0	56,8	68,8	109,0	149,7	182,9	218,2	255,6	294,9	336,0
	HIS-N 8.8		25,0	46,0	67,0	109,0	116,0	-	-	-	-	-	-
Shear	HAS-U 5.8	$V_{\text{Rk}}$ [kN]	11,0	17,4	25,3	47,1	73,5	105,9	137,7	168,3	208,2	245,1	292,8
	HAS-U 8.8, AM 8.8		14,6	23,2	33,7	62,8	98,0	141,2	183,6	224,4	277,6	326,8	390,4
	HAS-U A4		12,8	20,3	29,5	55,0	85,8	123,6	114,8	140,3	173,5	204,3	244,0
	HAS-U HCR		14,6	23,2	33,7	62,8	98,0	123,6	160,7	196,4	173,5	204,3	244,0
	HIS-N 8.8		13,0	23,0	34,0	63,0	58,0	-	-	-	-	-	-
<b>Cracked concrete</b>													
Tension	HAS-U 5.8	$N_{\text{Rk}}$ [kN]	15,1	25,4	39,7	48,1	76,3	104,8	128,0	152,8	-	-	-
	HAS-U 8.8, AM 8.8		15,1	25,4	39,7	48,1	76,3	104,8	128,0	152,8	-	-	-
	HAS-U A4		15,1	25,4	39,7	48,1	76,3	104,8	128,0	152,8	-	-	-
	HAS-U HCR		15,1	25,4	39,7	48,1	76,3	104,8	128,0	152,8	-	-	-
	HIS-N 8.8		25,0	39,7	48,1	76,3	101,1	-	-	-	-	-	-
Shear	HAS-U 5.8	$V_{\text{Rk}}$ [kN]	11,0	17,4	25,3	47,1	73,5	105,9	137,7	168,3	-	-	-
	HAS-U 8.8, AM 8.8		14,6	23,2	33,7	62,8	98,0	141,2	183,6	224,4	-	-	-
	HAS-U A4		12,8	20,3	29,5	55,0	85,8	123,6	114,8	140,3	-	-	-
	HAS-U HCR		14,6	23,2	33,7	62,8	98,0	123,6	160,7	196,4	-	-	-
	HIS-N 8.8		13,0	23,0	34,0	63,0	58,0	-	-	-	-	-	-

<sup>1)</sup> Hilti hollow drill bit available for element size M12-M30.

<sup>2)</sup> Hilti Roughening tools are available for element size M16-M30.

**Design resistance**

Anchor size		ETA-20/0541, issued 2021-09-04							Hilti tech. data					
		M8	M10	M12	M16	M20	M24	M27	M30	M33	M36	M39		
<b>Non-cracked concrete</b>														
Tension	HAS-U 5.8	N <sub>Rd</sub>	[kN]	12,2	19,3	28,1	45,8	72,7	99,8	121,9	145,5	142,0	163,8	186,7
	HAS-U 8.8, AM 8.8			19,5	28,0	37,8	45,8	72,7	99,8	121,9	145,5	142,0	163,8	186,7
	HAS-U A4			13,7	21,7	31,6	45,8	72,7	99,8	80,2	98,1	121,3	142,8	170,6
	HAS-U HCR			19,5	28,0	37,8	45,8	72,7	99,8	121,9	145,5	142,0	163,8	186,7
	HIS-N 8.8			16,7	30,7	44,7	72,7	77,3	-	-	-	-	-	-
Shear	HAS-U 5.8	V <sub>Rd</sub>	[kN]	8,8	13,9	20,2	37,7	58,8	84,7	110,2	134,6	166,6	196,1	234,2
	HAS-U 8.8, AM 8.8			11,7	18,6	27,0	50,2	78,4	113,0	146,9	179,5	222,1	261,4	312,3
	HAS-U A4			8,2	13,0	18,9	35,2	55,0	79,2	48,2	58,9	72,9	85,8	102,5
	HAS-U HCR			11,7	18,6	27,0	50,2	78,4	70,6	91,8	112,2	87,0	102,0	122,0
	HIS-N 8.8			10,4	18,4	27,2	50,4	46,4	-	-	-	-	-	-
<b>Cracked concrete</b>														
Tension	HAS-U 5.8	N <sub>Rd</sub>	[kN]	10,0	17,0	26,5	32,1	50,9	69,9	85,4	101,8	-	-	-
	HAS-U 8.8, AM 8.8			10,0	17,0	26,5	32,1	50,9	69,9	85,4	101,8	-	-	-
	HAS-U A4			10,0	17,0	26,5	32,1	50,9	69,9	80,2	98,1	-	-	-
	HAS-U HCR			10,0	17,0	26,5	32,1	50,9	69,9	85,4	101,8	-	-	-
	HIS-N 8.8			16,7	26,5	32,1	50,9	67,4	-	-	-	-	-	-
Shear	HAS-U 5.8	V <sub>Rd</sub>	[kN]	8,8	13,9	20,2	37,7	58,8	84,7	110,2	134,6	-	-	-
	HAS-U 8.8, AM 8.8			11,7	18,6	27,0	50,2	78,4	113,0	146,9	179,5	-	-	-
	HAS-U A4			8,2	13,0	18,9	35,2	55,0	79,2	48,2	58,9	-	-	-
	HAS-U HCR			11,7	18,6	27,0	50,2	78,4	70,6	91,8	112,2	-	-	-
	HIS-N 8.8			10,4	18,4	27,2	50,4	46,4	-	-	-	-	-	-

**Recommended loads<sup>a)</sup>**

Anchor size		ETA-20/0541, issued 2021-09-04							Hilti tech. data					
		M8	M10	M12	M16	M20	M24	M27	M30	M33	M36	M39		
<b>Non-cracked concrete</b>														
Tension	HAS-U 5.8	N <sub>Rec</sub>	[kN]	8,7	13,8	20,1	32,7	51,9	71,3	87,1	103,9	101,4	117,0	133,3
	HAS-U 8.8, AM 8.8			13,9	20,0	27,0	32,7	51,9	71,3	87,1	103,9	101,4	117,0	133,3
	HAS-U A4			9,8	15,5	22,5	32,7	51,9	71,3	57,3	70,1	86,7	102,0	121,9
	HAS-U HCR			13,9	20,0	27,0	32,7	51,9	71,3	87,1	103,9	101,4	117,0	133,3
	HIS-N 8.8			11,9	21,9	31,9	51,9	55,2	-	-	-	-	-	-
Shear	HAS-U 5.8	V <sub>Rec</sub>	[kN]	6,3	9,9	14,5	26,9	42,0	60,5	78,7	96,2	119,0	140,1	167,3
	HAS-U 8.8, AM 8.8			8,4	13,3	19,3	35,9	56,0	80,7	104,9	128,2	158,6	186,7	223,1
	HAS-U A4			5,9	9,3	13,5	25,2	39,3	56,6	34,4	42,1	52,1	61,3	73,2
	HAS-U HCR			8,4	13,3	19,3	35,9	56,0	50,4	65,6	80,1	62,1	72,9	87,1
	HIS-N 8.8			7,4	13,1	19,4	36,0	33,1	-	-	-	-	-	-
<b>Cracked concrete</b>														
Tension	HAS-U 5.8	N <sub>Rec</sub>	[kN]	7,2	12,1	18,9	22,9	36,3	49,9	61,0	72,7	-	-	-
	HAS-U 8.8, AM 8.8			7,2	12,1	18,9	22,9	36,3	49,9	61,0	72,7	-	-	-
	HAS-U A4			7,2	12,1	18,9	22,9	36,3	49,9	57,3	70,1	-	-	-
	HAS-U HCR			7,2	12,1	18,9	22,9	36,3	49,9	61,0	72,7	-	-	-
	HIS-N 8.8			11,9	18,9	22,9	36,3	48,1	-	-	-	-	-	-
Shear	HAS-U 5.8	V <sub>Rec</sub>	[kN]	6,3	9,9	14,5	26,9	42,0	60,5	78,7	96,2	-	-	-
	HAS-U 8.8, AM 8.8			8,4	13,3	19,3	35,9	56,0	80,7	104,9	128,2	-	-	-
	HAS-U A4			5,9	9,3	13,5	25,2	39,3	56,6	34,4	42,1	-	-	-
	HAS-U HCR			8,4	13,3	19,3	35,9	56,0	50,4	65,6	80,1	-	-	-
	HIS-N 8.8			7,4	13,1	19,4	36,0	33,1	-	-	-	-	-	-

<sup>a)</sup> With overall partial safety factor for action  $\gamma=1,4$ . The partial safety factors for action depend on the type of loading and shall be taken from national regulations.

**For diamond drilling:  
Characteristic resistance**

Anchor size		ETA-20/0541, issued 2021-09-04							
		M8	M10	M12	M16	M20	M24	M27	M30
<b>Non-cracked concrete</b>									
Tension $N_{Rk}$	HAS-U 5.8	18,3	29,0	42,2	68,8	109,0	149,7	182,9	218,2
	HAS-U 8.8, AM 8.8	26,1	36,7	53,9	68,8	109,0	149,7	182,9	218,2
	HAS-U A4	25,6	36,7	53,9	68,8	109,0	149,7	182,9	218,2
	HAS-U HCR	26,1	36,7	53,9	68,8	109,0	149,7	182,9	218,2
	HIS-N 8.8	25,0	46,0	67,0	109,0	116,0	-	-	-
Shear $V_{Rk}$	HAS-U 5.8	11,0	17,4	25,3	47,1	73,5	105,9	137,7	168,3
	HAS-U 8.8, AM 8.8	14,6	23,2	33,7	62,8	98,0	141,2	183,6	224,4
	HAS-U A4	12,8	20,3	29,5	55,0	85,8	123,6	114,8	140,3
	HAS-U HCR	14,6	23,2	33,7	62,8	98,0	123,6	160,7	196,4
	HIS-N 8.8	13,0	23,0	34,0	63,0	58,0	-	-	-

**Design resistance**

Anchor size		ETA-20/0541, issued 2021-09-04							
		M8	M10	M12	M16	M20	M24	M27	M30
<b>Non-cracked concrete</b>									
Tension $N_{Rd}$	HAS-U 5.8	12,2	19,3	28,1	32,7	51,9	71,3	87,1	103,9
	HAS-U 8.8, AM 8.8	14,5	20,4	29,9	32,7	51,9	71,3	87,1	103,9
	HAS-U A4	13,7	20,4	29,9	32,7	51,9	71,3	80,2	98,1
	HAS-U HCR	14,5	20,4	29,9	32,7	51,9	71,3	87,1	103,9
	HIS-N 8.8	16,7	24,4	32,7	51,9	68,8	-	-	-
Shear $V_{Rd}$	HAS-U 5.8	8,8	13,9	20,2	37,7	58,8	84,7	110,2	134,6
	HAS-U 8.8, AM 8.8	11,7	18,6	27,0	50,2	78,4	113,0	146,9	179,5
	HAS-U A4	8,2	13,0	18,9	35,2	55,0	79,2	48,2	58,9
	HAS-U HCR	11,7	18,6	27,0	50,2	78,4	70,6	91,8	112,2
	HIS-N 8.8	10,4	18,4	27,2	50,4	46,4	-	-	-

**Recommended loads<sup>a)</sup>**

Anchor size		ETA-20/0541, issued 2021-09-04							
		M8	M10	M12	M16	M20	M24	M27	M30
<b>Non-cracked concrete</b>									
Tension $N_{Rec}$	HAS-U 5.8	8,7	13,8	20,1	23,4	37,1	50,9	62,2	74,2
	HAS-U 8.8, AM 8.8	10,4	14,6	21,4	23,4	37,1	50,9	62,2	74,2
	HAS-U A4	9,8	14,6	21,4	23,4	37,1	50,9	57,3	70,1
	HAS-U HCR	10,4	14,6	21,4	23,4	37,1	50,9	62,2	74,2
	HIS-N 8.8	11,9	17,5	23,4	37,1	49,1	-	-	-
Shear $V_{Rec}$	HAS-U 5.8	6,3	9,9	14,5	26,9	42,0	60,5	78,7	96,2
	HAS-U 8.8, AM 8.8	8,4	13,3	19,3	35,9	56,0	80,7	104,9	128,2
	HAS-U A4	5,9	9,3	13,5	25,2	39,3	56,6	34,4	42,1
	HAS-U HCR	8,4	13,3	19,3	35,9	56,0	50,4	65,6	80,1
	HIS-N 8.8	7,4	13,1	19,4	36,0	33,1	-	-	-

<sup>a)</sup> With overall partial safety factor for action  $\gamma=1,4$ . The partial safety factors for action depend on the type of loading and shall be taken from national regulations.



**Static and quasi-static resistance (for a single anchor) – Working life 100 years**
**All data in this section applies to:**

- Correct setting (see setting instruction)
- No edge distance and spacing influence
- Steel failure
- HAS-U anchor rod with strength class 5.8 and 8.8, AM anchor rod with strength class 8.8, HIS-N internally threaded insert with screw 8.8
- Base material thickness and one typical embedment depth, as specified in the table
- Concrete C 20/25
- In-service temperature range I: -40 °C to +40 °C  
(min. base material temperature -40 °C, max. long/short term base material temperature: +24 °C/40 °C)
- Short term loading. For long term loading apply  $\psi_{sus}$  acc. to EN 1992-4

**Embedment depth <sup>a)</sup> and base material thickness**

Anchor size			ETA-20/0541, issued 2021-09-04							
			M8	M10	M12	M16	M20	M24	M27	M30
<b>HAS-U</b>										
Effective anchorage depth	$h_{ef}$	[mm]	80	90	110	125	170	210	240	270
Base material thickness	$h$	[mm]	110	120	140	161	214	266	300	340
<b>HIS-N</b>										
Effective anchorage depth	$h_{ef}$	[mm]	90	110	125	170	205	-	-	-
Base material thickness	$h$	[mm]	120	150	170	230	270	-	-	-

<sup>a)</sup> The allowed range of embedment depth is shown in the setting details.

**For hammer drilled holes, hammer drilled holes with hollow drill bit<sup>1)</sup> and diamond cored with Hilti roughening tool<sup>2)</sup>:**
**Characteristic resistance**

Anchor size			ETA-20/0541, issued 2021-09-04							
			M8	M10	M12	M16	M20	M24	M27	M30
<b>Non-cracked concrete</b>										
Tension	HAS-U 5.8	$N_{Rk}$ [kN]	18,3	29,0	42,2	68,8	109,0	149,7	182,9	218,2
	HAS-U 8.8, AM 8.8		29,3	42,0	56,8	68,8	109,0	149,7	182,9	218,2
	HAS-U A4		25,6	40,6	56,8	68,8	109,0	149,7	182,9	218,2
	HAS-U HCR		29,3	42,0	56,8	68,8	109,0	149,7	182,9	218,2
	HIS-N 8.8		25,0	46,0	67,0	109,0	116,0	-	-	-
Shear	HAS-U 5.8	$V_{Rk}$ [kN]	11,0	17,4	25,3	47,1	73,5	105,9	137,7	168,3
	HAS-U 8.8, AM 8.8		14,6	23,2	33,7	62,8	98,0	141,2	183,6	224,4
	HAS-U A4		12,8	20,3	29,5	55,0	85,8	123,6	114,8	140,3
	HAS-U HCR		14,6	23,2	33,7	62,8	98,0	123,6	160,7	196,4
	HIS-N 8.8		13,0	23,0	34,0	63,0	58,0	-	-	-
<b>Cracked concrete</b>										
Tension	HAS-U 5.8	$N_{Rk}$ [kN]	14,1	22,6	37,3	48,1	76,3	104,8	128,0	152,8
	HAS-U 8.8, AM 8.8		14,1	22,6	37,3	48,1	76,3	104,8	128,0	152,8
	HAS-U A4		14,1	22,6	37,3	48,1	76,3	104,8	128,0	152,8
	HAS-U HCR		14,1	22,6	37,3	48,1	76,3	104,8	128,0	152,8
	HIS-N 8.8		24,7	39,7	48,1	76,3	101,1	-	-	-
Shear	HAS-U 5.8	$V_{Rk}$ [kN]	11,0	17,4	25,3	47,1	73,5	105,9	137,7	168,3
	HAS-U 8.8, AM 8.8		14,6	23,2	33,7	62,8	98,0	141,2	183,6	224,4
	HAS-U A4		12,8	20,3	29,5	55,0	85,8	123,6	114,8	140,3
	HAS-U HCR		14,6	23,2	33,7	62,8	98,0	123,6	160,7	196,4
	HIS-N 8.8		13,0	23,0	34,0	63,0	58,0	-	-	-

<sup>1)</sup> Hilti hollow drill bit available for element size M12-M30.

<sup>2)</sup> Hilti Roughening tools are available for element size M16-M30.



**Design resistance**

Anchor size		ETA-20/0541, issued 2021-09-04									
		M8	M10	M12	M16	M20	M24	M27	M30		
<b>Non-cracked concrete</b>											
Tension	HAS-U 5.8	N <sub>Rd</sub>	[kN]	12,2	19,3	28,1	45,8	72,7	99,8	121,9	145,5
	HAS-U 8.8, AM 8.8			19,5	28,0	37,8	45,8	72,7	99,8	121,9	145,5
	HAS-U A4			13,7	21,7	31,6	45,8	72,7	99,8	80,2	98,1
	HAS-U HCR			19,5	28,0	37,8	45,8	72,7	99,8	121,9	145,5
	HIS-N 8.8			16,7	30,7	44,7	72,7	77,3	-	-	-
Shear	HAS-U 5.8	V <sub>Rd</sub>	[kN]	8,8	13,9	20,2	37,7	58,8	84,7	110,2	134,6
	HAS-U 8.8, AM 8.8			11,7	18,6	27,0	50,2	78,4	113,0	146,9	179,5
	HAS-U A4			8,2	13,0	18,9	35,2	55,0	79,2	48,2	58,9
	HAS-U HCR			11,7	18,6	27,0	50,2	78,4	70,6	91,8	112,2
	HIS-N 8.8			10,4	18,4	27,2	50,4	46,4	-	-	-
<b>Cracked concrete</b>											
Tension	HAS-U 5.8	N <sub>Rd</sub>	[kN]	9,4	15,1	24,9	32,1	50,9	69,9	85,4	101,8
	HAS-U 8.8, AM 8.8			9,4	15,1	24,9	32,1	50,9	69,9	85,4	101,8
	HAS-U A4			9,4	15,1	24,9	32,1	50,9	69,9	80,2	98,1
	HAS-U HCR			9,4	15,1	24,9	32,1	50,9	69,9	85,4	101,8
	HIS-N 8.8			16,5	26,5	32,1	50,9	67,4	-	-	-
Shear	HAS-U 5.8	V <sub>Rd</sub>	[kN]	8,8	13,9	20,2	37,7	58,8	84,7	110,2	134,6
	HAS-U 8.8, AM 8.8			11,7	18,6	27,0	50,2	78,4	113,0	146,9	179,5
	HAS-U A4			8,2	13,0	18,9	35,2	55,0	79,2	48,2	58,9
	HAS-U HCR			11,7	18,6	27,0	50,2	78,4	70,6	91,8	112,2
	HIS-N 8.8			10,4	18,4	27,2	50,4	46,4	-	-	-

**Recommended loads<sup>a)</sup>**

Anchor size		ETA-20/0541, issued 2021-09-04									
		M8	M10	M12	M16	M20	M24	M27	M30		
<b>Non-cracked concrete</b>											
Tension	HAS-U 5.8	N <sub>Rec</sub>	[kN]	8,7	13,8	20,1	32,7	51,9	71,3	87,1	103,9
	HAS-U 8.8, AM 8.8			13,9	20,0	27,0	32,7	51,9	71,3	87,1	103,9
	HAS-U A4			9,8	15,5	22,5	32,7	51,9	71,3	57,3	70,1
	HAS-U HCR			13,9	20,0	27,0	32,7	51,9	71,3	87,1	103,9
	HIS-N 8.8			11,9	21,9	31,9	51,9	55,2	-	-	-
Shear	HAS-U 5.8	V <sub>Rec</sub>	[kN]	6,3	9,9	14,5	26,9	42,0	60,5	78,7	96,2
	HAS-U 8.8, AM 8.8			8,4	13,3	19,3	35,9	56,0	80,7	104,9	128,2
	HAS-U A4			5,9	9,3	13,5	25,2	39,3	56,6	34,4	42,1
	HAS-U HCR			8,4	13,3	19,3	35,9	56,0	50,4	65,6	80,1
	HIS-N 8.8			7,4	13,1	19,4	36,0	33,1	-	-	-
<b>Cracked concrete</b>											
Tension	HAS-U 5.8	N <sub>Rec</sub>	[kN]	6,7	10,8	17,8	22,9	36,3	49,9	61,0	72,7
	HAS-U 8.8, AM 8.8			6,7	10,8	17,8	22,9	36,3	49,9	61,0	72,7
	HAS-U A4			6,7	10,8	17,8	22,9	36,3	49,9	57,3	70,1
	HAS-U HCR			6,7	10,8	17,8	22,9	36,3	49,9	61,0	72,7
	HIS-N 8.8			11,8	18,9	22,9	36,3	48,1	-	-	-
Shear	HAS-U 5.8	V <sub>Rec</sub>	[kN]	6,3	9,9	14,5	26,9	42,0	60,5	78,7	96,2
	HAS-U 8.8, AM 8.8			8,4	13,3	19,3	35,9	56,0	80,7	104,9	128,2
	HAS-U A4			5,9	9,3	13,5	25,2	39,3	56,6	34,4	42,1
	HAS-U HCR			8,4	13,3	19,3	35,9	56,0	50,4	65,6	80,1
	HIS-N 8.8			7,4	13,1	19,4	36,0	33,1	-	-	-

<sup>a)</sup> With overall partial safety factor for action  $\gamma=1,4$ . The partial safety factors for action depend on the type of loading and shall be taken from national regulations.

**For diamond coring:**
**Characteristic resistance**

Anchor size		ETA-20/0541, issued 2021-09-04								
		M8	M10	M12	M16	M20	M24	M27	M30	
<b>Non-cracked concrete</b>										
Tension	HAS-U 5.8	N <sub>Rk</sub> [kN]	18,3	29,0	42,2	68,8	109,0	149,7	182,9	218,2
	HAS-U 8.8, AM 8.8		26,1	36,7	53,9	68,8	109,0	149,7	182,9	218,2
	HAS-U A4		26,0	36,7	53,9	68,8	109,0	149,7	182,9	218,2
	HAS-U HCR		26,1	36,7	53,9	68,8	109,0	149,7	182,9	218,2
	HIS-N 8.8		25,0	46,0	67,0	109,0	116	-	-	-
Shear	HAS-U 5.8	V <sub>Rk</sub> [kN]	11,0	17,4	25,3	47,1	73,5	105,9	137,7	168,3
	HAS-U 8.8, AM 8.8		14,6	23,2	33,7	62,8	98,0	141,2	183,6	224,4
	HAS-U A4		12,8	20,3	29,5	55,0	85,8	123,6	114,8	140,3
	HAS-U HCR		14,6	23,2	33,7	62,8	98,0	123,6	160,7	196,4
	HIS-N 8.8		13,0	23,0	34,0	63,0	58,0	-	-	-

**Design resistance**

Anchor size		ETA-20/0541, issued 2021-09-04								
		M8	M10	M12	M16	M20	M24	M27	M30	
<b>Non-cracked concrete</b>										
Tension	HAS-U 5.8	N <sub>Rd</sub> [kN]	12,2	19,3	28,1	32,7	51,9	71,3	87,1	103,9
	HAS-U 8.8, AM 8.8		14,5	20,4	29,9	32,7	51,9	71,3	87,1	103,9
	HAS-U A4		13,7	20,4	29,9	32,7	51,9	71,3	80,4	98,1
	HAS-U HCR		14,5	20,4	29,9	32,7	51,9	71,3	87,1	103,9
	HIS-N 8.8		16,7	24,4	32,7	51,9	68,8	-	-	-
Shear	HAS-U 5.8	V <sub>Rd</sub> [kN]	8,8	13,9	20,2	37,7	58,8	84,7	110,2	134,6
	HAS-U 8.8, AM 8.8		11,7	18,6	27,0	50,2	78,4	113,0	146,9	179,5
	HAS-U A4		8,2	13,0	18,9	35,2	55,0	79,2	48,2	58,9
	HAS-U HCR		11,7	18,6	27,0	50,2	78,4	70,6	91,8	112,2
	HIS-N 8.8		10,4	18,4	27,2	50,4	46,4	-	-	-

**Recommended loads<sup>a)</sup>**

Anchor size		ETA-20/0541, issued 2021-09-04								
		M8	M10	M12	M16	M20	M24	M27	M30	
<b>Non-cracked concrete</b>										
Tension	HAS-U 5.8	N <sub>Rd</sub> [kN]	8,7	13,8	20,1	23,4	37,1	50,9	62,2	74,2
	HAS-U 8.8, AM 8.8		10,4	14,6	21,4	23,4	37,1	50,9	62,2	74,2
	HAS-U A4		9,8	14,6	21,4	23,4	37,1	50,9	57,3	70,1
	HAS-U HCR		10,4	14,6	21,4	23,4	37,1	50,9	62,2	74,2
	HIS-N 8.8		11,9	17,5	23,4	37,1	49,1	-	-	-
Shear	HAS-U 5.8	V <sub>Rd</sub> [kN]	6,3	9,9	14,5	26,9	42,0	60,5	78,7	96,2
	HAS-U 8.8, AM 8.8		8,4	13,3	19,3	35,9	56,0	80,7	104,9	128,2
	HAS-U A4		5,9	9,3	13,5	25,2	39,3	56,6	34,4	42,1
	HAS-U HCR		8,4	13,3	19,3	35,9	56,0	50,4	65,6	80,1
	HIS-N 8.8		7,4	13,1	19,4	36,0	33,1	-	-	-

<sup>a)</sup> With overall partial safety factor for action  $\gamma=1,4$ . The partial safety factors for action depend on the type of loading and shall be taken from national regulations.

**Seismic resistance (for a single anchor) – Working life 50 years**
**All data in this section applies to:**

- Correct setting (see setting instruction)
- No edge distance and spacing influence
- Steel failure
- HAS-U anchor rod with strength class 8.8, AM anchor rod with strength class 8.8, HIS-N internally threaded insert with screw 8.8
- Base material thickness and one typical embedment depth, as specified in the table
- Concrete C 20/25
- In-service temperature range I  
(min. base material temperature -40 °C, max. long/short term base material temperature: +24 °C/40 °C)
- $\alpha_{\text{gap}}=1,0$  (using Hilti seismic filling set) or  $\alpha_{\text{gap}}=0,5$  (without using Hilti seismic filling set) accordingly

**Embedment depth and base material thickness for seismic C2<sup>a)</sup> and C1**

Anchor size		ETA-20/0541, issued 2021-09-04							
		M8	M10	M12	M16	M20	M24	M27	M30
<b>HAS-U</b>									
Effective anchorage depth	$h_{\text{ef}}$ [mm]	80	90	110	125	170	210	240	270
Base material thickness	$h$ [mm]	110	120	140	161	214	266	300	340
<b>HIS-N</b>									
Effective anchorage depth	$h_{\text{ef}}$ [mm]	90	110	125	170	205	-	-	-
Base material thickness	$h$ [mm]	120	146	169	226	269	-	-	-

a) C2 seismic approval only available for HAS-U rods.

**For hammer drilled holes and hammer drilled holes with Hilti hollow drill bit<sup>1)</sup>:**
**Characteristic resistance in case of seismic performance category C2**

Anchor size		ETA-20/0541, issued 2021-09-04							
		M8	M10	M12	M16	M20	M24	M27	M30
Tension	HAS-U 8.8, AM 8.8 $N_{\text{Rk,seis}}$ [kN]	-	-	15,3	40,8	61,9	89,1	101,7	129,9
	HAS-U 8.8 HDG, AM 8.8 HDG	-	-	15,3	40,8	61,9	89,1	101,7	129,9
<b>with Hilti filling set</b>									
Shear	HAS-U 8.8, AM 8.8 $V_{\text{Rk,seis}}$ [kN]	-	-	28,0	46,0	77,0	103,0	- <sup>2)</sup>	- <sup>2)</sup>
	HAS-U 8.8 HDG, AM 8.8 HDG	-	-	18,0	30,0	46,0	66,0	- <sup>2)</sup>	- <sup>2)</sup>
<b>without Hilti filling set</b>									
Shear	HAS-U 8.8, AM 8.8 $V_{\text{Rk,seis}}$ [kN]	-	-	12,0	20,0	35,5	45,0	60,5	67,5
	HAS-U 8.8 HDG, AM 8.8 HDG	-	-	9,0	15,0	23,0	33,0	- <sup>3)</sup>	- <sup>3)</sup>

1) Hilti hollow drill bit available for element size M12-M30;

2) Hilti filling set is not available in size M27, M30;

3) No performance assessed

**Design resistance in case of seismic performance category C2**

Anchor size		ETA-20/0541, issued 2021-09-04							
		M8	M10	M12	M16	M20	M24	M27	M30
Tension	HAS-U 8.8, AM 8.8 $N_{\text{Rd,seis}}$ [kN]	-	-	10,2	27,2	41,3	59,4	67,8	86,6
	HAS-U 8.8 HDG, AM 8.8 HDG	-	-	10,2	27,2	41,3	59,4	67,8	86,6
<b>with Hilti filling set</b>									
Shear	HAS-U 8.8, AM 8.8 $V_{\text{Rd,seis}}$ [kN]	-	-	22,4	36,8	61,6	82,4	- <sup>2)</sup>	- <sup>2)</sup>
	HAS-U 8.8 HDG, AM 8.8 HDG	-	-	14,4	24,0	36,8	52,8	- <sup>2)</sup>	- <sup>2)</sup>
<b>without Hilti filling set</b>									
Shear	HAS-U 8.8, AM 8.8 $V_{\text{Rd,seis}}$ [kN]	-	-	9,6	16,0	28,4	36,0	48,4	54,0
	HAS-U 8.8 HDG, AM 8.8 HDG	-	-	7,2	12,0	18,4	26,4	- <sup>3)</sup>	- <sup>3)</sup>

1) Hilti hollow drill bit available for element size M12-M30;

2) Hilti filling set is not available in size M27, M30

3) No performance assessed

**For hammer drilled holes and hammer drilled holes with Hilti hollow drill bit<sup>1)</sup>:**
**Characteristic resistance in case of seismic performance category C1**

Anchor size		ETA-20/0541, issued 2021-09-04								
		M8	M10	M12	M16	M20	M24	M27	M30	
Tension	HAS-U 8.8, AM 8.8	$N_{Rk,seis}$ [kN]	13,7	23,2	33,8	40,9	64,9	89,1	108,8	129,9
	HIS-N 8.8		25,0	33,8	40,9	64,9	85,9	-	-	-
<b>with Hilti filling set</b>										
Shear	HAS-U 8.8, AM 8.8	$V_{Rk,seis}$ [kN]	14,6	23,2	33,7	62,8	98,0	141,2	- <sup>2)</sup>	- <sup>2)</sup>
	HIS-N 8.8		9,0	16,0	27,0	41,0	39,0	-	-	-
<b>without Hilti filling set</b>										
Shear	HAS-U 8.8, AM 8.8	$V_{Rk,seis}$ [kN]	7,3	11,6	16,9	31,4	49,0	70,6	91,8	112,2
	HIS-N 8.8		4,5	8,0	13,5	20,5	19,5			

1) Hilti hollow drill bit available for element size M12-M30;

2) Hilti filling set is not available in size M27, M30

**Design resistance in case of seismic performance category C1**

Anchor size		ETA-20/0541, issued 2021-09-04								
		M8	M10	M12	M16	M20	M24	M27	M30	
Tension	HAS-U 8.8, AM 8.8	$N_{Rd,seis}$ [kN]	9,1	15,4	22,5	27,3	43,3	59,4	72,6	86,6
	HIS-N 8.8		16,7	22,5	27,3	43,3	57,3	-	-	-
<b>with Hilti filling set</b>										
Shear	HAS-U 8.8, AM 8.8	$V_{Rd,seis}$ [kN]	11,7	18,6	27,0	50,2	78,4	113,0	- <sup>2)</sup>	- <sup>2)</sup>
	HIS-N 8.8		7,2	12,8	21,6	32,8	31,2	-	-	-
<b>without Hilti filling set</b>										
Shear	HAS-U 8.8, AM 8.8	$V_{Rd,seis}$ [kN]	5,9	9,3	13,5	25,1	39,2	56,5	73,4	89,8
	HIS-N 8.8		3,6	6,4	10,8	16,4	15,6	-	-	-

1) Hilti hollow drill bit available for element size M12-M30;

2) Hilti filling set is not available in size M27, M30

**Materials**
**Mechanical properties for HAS-U**

Anchor size		ETA-20/0541, issued 2021-09-04							Hilti tech. data				
		M8	M10	M12	M16	M20	M24	M27	M30	M33	M36	M39	
Nominal tensile strength	HAS-U 5.8 (HDG)	$f_{uk}$ [N/mm <sup>2</sup> ]	500	500	500	500	500	500	500	500	500	500	
	HAS-U 8.8 (HDG)		800	800	800	800	800	800	800	800	800	800	
	AM 8.8 (HDG)		800	800	800	800	800	800	800	800	800	800	
	HAS-U A4		700	700	700	700	700	700	500	500	500	500	
	HAS-U HCR		800	800	800	800	800	700	700	700	500	500	
Yield strength	HAS-U 5.8 (HDG)	$f_{yk}$ [N/mm <sup>2</sup> ]	400	400	400	400	400	400	400	400	400	400	
	HAS-U 8.8 (HDG)		640	640	640	640	640	640	640	640	640	640	
	AM 8.8 (HDG)		640	640	640	640	640	640	640	640	640	640	
	HAS-U A4		450	450	450	450	450	450	210	210	210	210	
	HAS-U HCR		640	640	640	640	640	400	400	400	250	250	
Stressed cross-section	HAS-U, AM 8.8	$A_s$ [mm <sup>2</sup> ]	36,6	58,0	84,3	157	245	353	459	561	694	817	976
Moment of resistance	HAS-U, AM 8.8	$W$ [mm <sup>3</sup> ]	31,2	62,3	109	277	541	935	1387	1874	2579	3294	4301

**Mechanical properties for HIS-N**

Anchor size		ETA-20/0541, issued 2021-09-04					
		M8	M10	M12	M16	M20	
Nominal tensile strength	HIS-N	$f_{uk}$ [N/mm <sup>2</sup> ]	490	490	460	460	460
	Screw 8.8		800	800	800	800	800
	HIS-RN		700	700	700	700	700
	Screw A4-70		700	700	700	700	700
Yield strength	HIS-N	$f_{yk}$ [N/mm <sup>2</sup> ]	410	410	375	375	375
	Screw 8.8		640	640	640	640	640
	HIS-RN		350	350	350	350	350
	Screw A4-70		450	450	450	450	450
Stressed cross-section	HIS-(R)N	$A_s$ [mm <sup>2</sup> ]	51,5	108	169	256	238
	Screw		36,6	58	84,3	157	245
Moment of resistance	HIS-(R)N	$W$ [mm <sup>3</sup> ]	145	430	840	1595	1543
	Screw		31,2	62,3	109	277	541

**Material quality for HAS-U**

Part	Material
<b>Zinc coated steel</b>	
Threaded rod, HAS-U 5.8 (HDG)	Strength class 5.8; Elongation at fracture A5 > 8% ductile Electroplated zinc coated $\geq 5\mu\text{m}$ ; (F) hot dip galvanized $\geq 50\mu\text{m}$
Threaded rod, HAS-U 8.8 (HDG)	Strength class 8.8; Elongation at fracture A5 > 12% ductile Electroplated zinc coated $\geq 5\mu\text{m}$ ; (F) hot dip galvanized $\geq 50\mu\text{m}$
Hilti Meter rod, AM 8.8 (HDG)	Strength class 8.8; Elongation at fracture A5 > 12% ductile Electroplated zinc coated $\geq 5\mu\text{m}$ (HDG) hot dip galvanized $\geq 50\mu\text{m}$
Washer	Electroplated zinc coated $\geq 5\mu\text{m}$ , hot dip galvanized $\geq 50\mu\text{m}$
Nut	Strength class of nut adapted to strength class of threaded rod. Electroplated zinc coated $\geq 5\mu\text{m}$ , hot dip galvanized $\geq 50\mu\text{m}$
<b>Stainless Steel</b>	
Threaded rod, HAS-U A4	Strength class 70 for $\leq M24$ and strength class 50 for $> M24$ ; Elongation at fracture A5 > 8% ductile Stainless steel 1.4401; 1.4404; 1.4578; 1.4571; 1.4439; 1.4362
Washer	Stainless steel 1.4401, 1.4404, 1.4578, 1.4571, 1.4439, 1.4362 EN 10088-1:2014
Nut	Stainless steel 1.4401, 1.4404, 1.4578, 1.4571, 1.4439, 1.4362 EN 10088-1:2014
<b>High corrosion resistant steel</b>	
Threaded rod, HAS-U HCR	Strength class 80 for $\leq M20$ and class 70 for $> M20$ , Elongation at fracture A5 > 8% ductile High corrosion resistance steel 1.4529; 1.4565;
Washer	High corrosion resistant steel 1.4529, 1.4565 EN 10088-1:2014
Nut	High corrosion resistant steel 1.4529, 1.4565 EN 10088-1:2014

**Material quality for HIS-N**

Part	Material	
HIS-N	Internal threaded sleeve	C-steel 1.0718; Steel galvanized $\geq 5\mu\text{m}$
	Screw 8.8	Strength class 8.8, A5 > 8 % ductile; Steel galvanized $\geq 5\mu\text{m}$
HIS-RN	Internal threaded sleeve	Stainless steel 1.4401, 1.4571
	Screw 70	Strength class 70, A5 > 8 % ductile Stainless steel 1.4401; 1.4404, 1.4578; 1.4571; 1.4439; 1.4362

## Setting information

### Installation temperature

-5 °C to +40 °C

### Service temperature range

Hilti HIT-RE 500 V4 injection mortar may be applied in the temperature ranges given below. An elevated base material temperature may lead to a reduction of the design bond resistance.

Temperature range	Base material temperature	Maximum long term base material temperature	Maximum short term base material temperature
Temperature range I	-40 °C to +40 °C	+24 °C	+40 °C
Temperature range II	-40 °C to +55 °C	+43 °C	+55 °C
Temperature range III	-40 °C to +75 °C	+55 °C	+75 °C

### Maximum short term base material temperature

Short-term elevated base material temperatures are those that occur over brief intervals, e.g. as a result of diurnal cycling.

### Maximum long term base material temperature

Long-term elevated base material temperatures are roughly constant over significant periods of time.

### Working time and curing time

Temperature of the base material $T_{BM}^{2)}$	Maximum working time $t_{work}$	Minimum curing time $t_{cure}^{1)}$
-5 °C to -1 °C	2 h	168 h
0 °C to 4 °C	2 h	48 h
5 °C to 9 °C	2 h	24 h
10 °C to 14 °C	1,5 h	16 h
15 °C to 19 °C	1 h	12 h
20 °C to 24 °C	30 min	7 h
25 °C to 29 °C	20 min	6 h
30 °C to 34 °C	15 min	5 h
35 °C to 39 °C	12 min	4,5 h
40 °C	10 min	4 h

<sup>1)</sup> The curing time data are valid for dry base material only. In wet base material, the curing times must be doubled.

<sup>2)</sup> The minimum temperature of the foil pack is +5° C.

**Setting details for HAS-U**

Anchor size			ETA-20/0541, issued 2021-09-04							Hilti tech. data			
			M8	M10	M12	M16	M20	M24	M27	M30	M33	M36	M39
Nominal diameter of element	d	[mm]	8	10	12	16	20	24	27	30	33	36	39
Nominal diameter of drill bit	d <sub>0</sub>	[mm]	10	12	14	18	22	28	30	35	37	40	42
Effective anchorage depth (=drill hole depth) <sup>a)</sup>	h <sub>ef,min</sub> = h <sub>0</sub>	[mm]	60	60	70	80	90	96	108	120	132	144	156
	h <sub>ef,max</sub> = h <sub>0</sub>	[mm]	160	200	240	320	400	480	540	600	660	720	780
Minimum base material thickness	h <sub>min</sub>	[mm]	h <sub>ef</sub> +30 mm ≥ 100 mm				h <sub>ef</sub> + 2 d <sub>0</sub>						
Maximum installation torque	T <sub>max</sub>	[Nm]	10	20	40	80	150	200	270	300	330	360	390
Minimum spacing	s <sub>min</sub>	[mm]	40	50	60	75	90	115	120	140	165	180	195
Minimum edge distance	c <sub>min</sub>	[mm]	40	45	45	50	55	60	75	80	165	180	195
Critical spacing for splitting failure	s <sub>cr,sp</sub>	[mm]	2 C <sub>cr,sp</sub>										
Critical edge distance for splitting failure <sup>b)</sup>	C <sub>cr,sp</sub>	[mm]	1,0 · h <sub>ef</sub>		for h / h <sub>ef</sub> ≥ 2,0								
			4,6 h <sub>ef</sub> - 1,8 h		for 2,0 > h / h <sub>ef</sub> > 1,3								
			2,26 h <sub>ef</sub>		for h / h <sub>ef</sub> ≤ 1,3								
Critical spacing for concrete cone failure	s <sub>cr,N</sub>	[mm]	2 C <sub>cr,N</sub>										
Critical edge distance for concrete cone failure	C <sub>cr,N</sub>	[mm]	1,5 h <sub>ef</sub>										

For spacing (edge distance) smaller than critical spacing (critical edge distance) the design loads have to be reduced.

a)  $h_{ef,min} \leq h_{ef} \leq h_{ef,max}$  (h<sub>ef</sub>: embedment depth)

b) h: base material thickness (h ≥ h<sub>min</sub>)

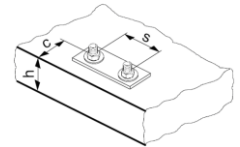
**HAS-U...**

**Marking:**

Steel grade number and length identification letter: e.g. 8 L



**Setting details for HIS-N**

Anchor size			ETA-20/0541, issued 2021-09-04				
			M8	M10	M12	M16	M20
Nominal diameter of drill bit	$d_0$	[mm]	14	18	22	28	32
Diameter of element	$d$	[mm]	12,5	16,5	20,5	25,4	27,6
Effective anchorage and drill hole depth	$h_{ef} = h_0$	[mm]	90	110	125	170	205
Minimum base material thickness	$h_{min}$	[mm]	120	150	170	230	270
Diameter of clearance hole in the fixture	$d_f$	[mm]	9	12	14	18	22
Thread engagement length; min - max	$h_s$	[mm]	8-20	10-25	12-30	16-40	20-50
Minimum spacing	$s_{min}$	[mm]	60	70	90	115	130
Minimum edge distance	$c_{min}$	[mm]	40	45	55	65	90
Critical spacing for splitting failure	$s_{cr,sp}$	[mm]	$2 c_{cr,sp}$				
Critical edge distance for splitting failure <sup>a)</sup>	$c_{cr,sp}$	[mm]	$1,0 \cdot h_{ef}$ for $h / h_{ef} \geq 2,0$				
			$4,6 h_{ef} - 1,8 h$ for $2,0 > h / h_{ef} > 1,3$				
			$2,26 h_{ef}$ for $h / h_{ef} \leq 1,3$				
Critical spacing for concrete cone failure	$s_{cr,N}$	[mm]	$2 c_{cr,N}$				
Critical edge distance for concrete cone failure	$c_{cr,N}$	[mm]	$1,5 h_{ef}$				
Maximum installation torque	$T_{max}$	[Nm]	10	20	40	80	150

For spacing (edge distance) smaller than critical spacing (critical edge distance) the design loads have to be reduced.

<sup>a)</sup>  $h$ : base material thickness ( $h \geq h_{min}$ )

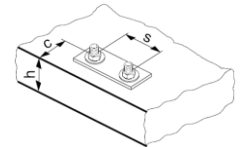
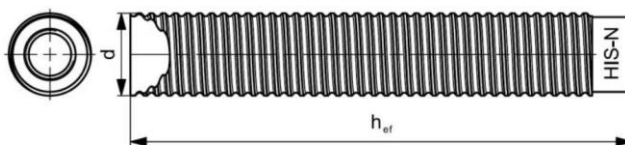
**Internally threaded sleeve HIS-(R)N...**

**Marking:**  
 Identifying mark - HILTI and  
 embossing "HIS-N" (for zinc coated steel)  
 embossing "HIS-RN" (for stainless steel)

**Installation equipment**

Anchor size		M8	M10	M12	M16	M20	M24	M27	M30	M36	M39
Rotary hammer	HAS-U	TE 2 – TE 16				TE 40 – TE 80					
	HIS-N	TE 2 – TE 16		TE 40 – TE 80			-				
Other tools		compressed air gun, set of cleaning brushes, dispenser									
Additional Hilti recommended tools (diamond coring tools)		roughening tools TE-YRT									-
		DD EC-1, DD 100 ... DD 160									-

**Parameters of cleaning and setting tools**

HAS-U	HIS-N	Drill bit diameters $d_0$ [mm]				Installation	
		Hammer drill (HD)	Hollow Drill Bit (HDB) <sup>a)</sup>	Diamond coring		Brush HIT-RB	Piston plug HIT-SZ
				Diamond coring (DD)	with roughening tool (RT)		
M8	-	10	-	10	-	10	-
M10	-	12	12	12	-	12	12
M12	M8	14	14	14	-	14	14
M16	M10	18	18	18	18	18	18
M20	M12	22	22	22	22	22	22
M24	M16	28	28	28	28	28	28
M27	-	30	-	30	30	30	30
-	M20	32	32	32	32	32	32
M30	-	35	35	35	35	35	35
M33 <sup>b)</sup>	-	37 <sup>b)</sup>	-	-	-	37 <sup>b)</sup>	37 <sup>b)</sup>
M36 <sup>b)</sup>	-	40 <sup>b)</sup>	-	-	-	40 <sup>b)</sup>	40 <sup>b)</sup>
M39 <sup>b)</sup>	-	42 <sup>b)</sup>	-	-	-	42 <sup>b)</sup>	42 <sup>b)</sup>

a) No cleaning required.

b) Additional Hilti technical data

**Associated components for the use of Hilti Roughening tool TE-YRT**

Diamond coring		Roughening tool TE-YRT		Wear gauge RTG...
$d_0$ [mm]		$d_0$ [mm]		size
nominal	measured			
18	17,9 to 18,2	18		18
20	19,9 to 20,2	20		20
22	21,9 to 22,2	22		22
25	24,9 to 25,2	25		25
28	27,9 to 28,2	28		28
30	29,9 to 30,2	30		30
32	31,9 to 32,2	32		32
35	34,9 to 35,2	35		35

**Minimum roughening time  $t_{\text{roughen}}$  ( $t_{\text{roughen}} [\text{sec}] = h_{\text{ef}} [\text{mm}] / 10$ )**

$h_{\text{ef}}$ [mm]	$t_{\text{roughen}}$ [sec]
0 to 100	10
101 to 200	20
201 to 300	30
301 to 400	40
401 to 500	50
501 to 600	60

## Setting instructions

\*For detailed information on installation see instruction for use given with the package of the product.



### Safety regulations

Review the Material Safety Data Sheet (MSDS) before use for proper and safe handling! Wear well-fitting protective goggles and protective gloves when working with Hilti HIT-RE 500 V4.

## Drilling

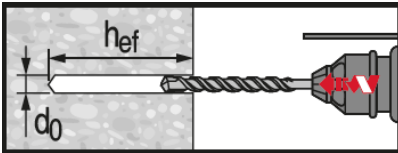

### Hammer drilled hole

For dry and wet concrete and installation in flooded holes (no sea water).

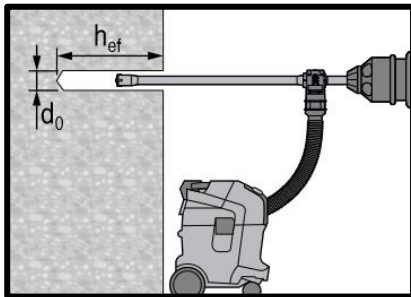

### Hammer drilled hole with Hollow Drilled Bit (HDB)

No cleaning required.  
For dry and wet concrete, only.

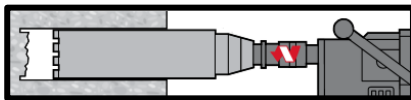

### Diamond Coring

For dry and wet concrete, only.

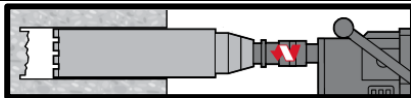

### Diamond Coring + Roughening Tool

For dry and wet concrete only.  
Before roughening, the borehole needs to be dry.

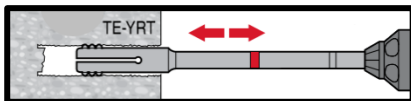

## Cleaning (Inadequate hole cleaning = poor load values.)

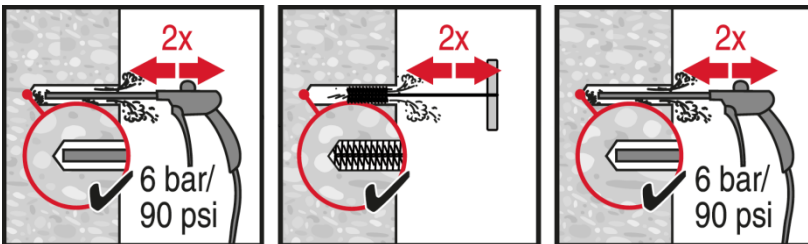

### Hammer Drilling:

#### Compressed air cleaning (CAC)

For all drill hole diameters  $d_0$  and all drill hole depths  $h_0$ .

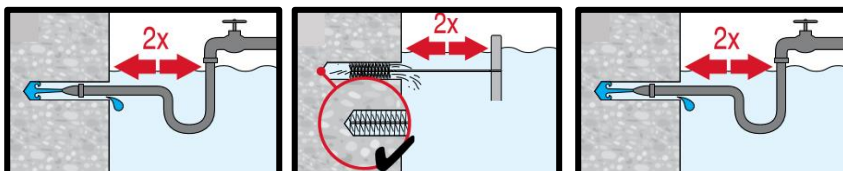

### Hammer drilling:

#### Cleaning for under water:

For all bore hole diameters  $d_0$  and all bore hole depth  $h_0$ .

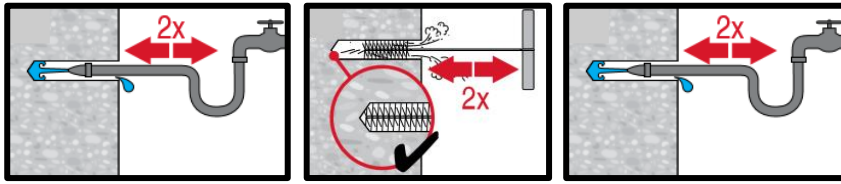

**Hammer drilled flooded holes and diamond cored holes:**

For all drill hole diameters  $d_0$  and drill hole depths  $h_0$ .

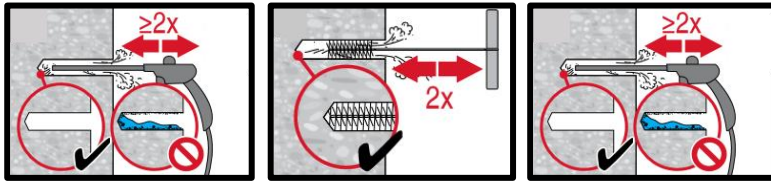

**Diamond cored holes with Hilti roughening tool:**

For all drill hole diameters  $d_0$  and drill hole depths  $h_0$ .

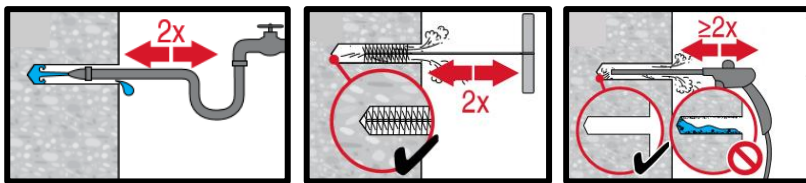

**Injection preparation**

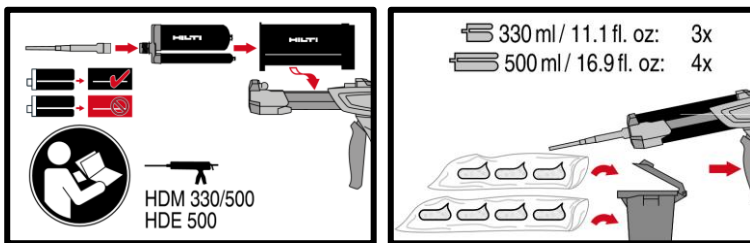

**Injection system preparation.**

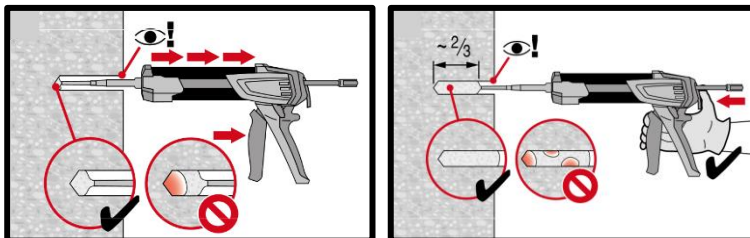

**Injection method for drill hole depth  $h_{ef} \leq 250$  mm.**

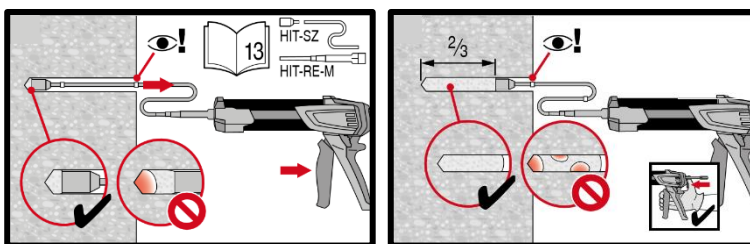

**Injection method for drill hole depth  $h_{ef} > 250$ mm.**

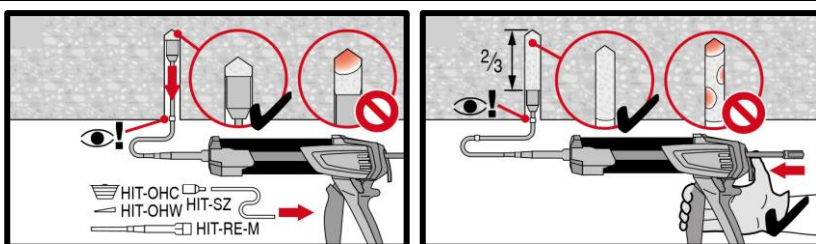

**Injection method for overhead application.**

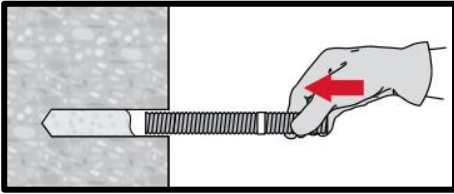
**Setting the element**

**Setting element**, observe working time " $t_{work}$ ".

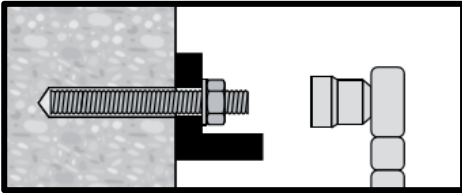

**Loading the anchor** after required curing time  $t_{cure}$  the anchor can be loaded. The applied installation torque shall not exceed max.  $T_{inst}$ .

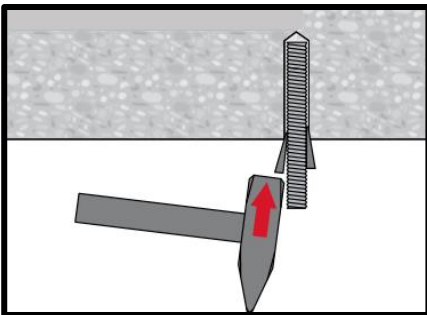

**Setting element** for overhead applications, observe working time " $t_{work}$ ".

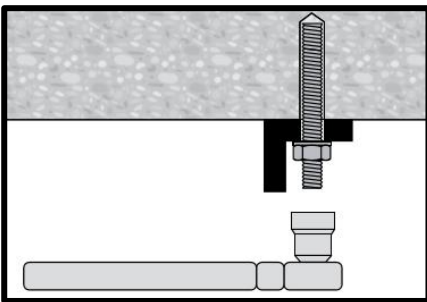

**Loading the anchor** after required curing time  $t_{cure}$  the anchor can be loaded. The applied installation torque shall not exceed max.  $T_{inst}$ .

# HIT-RE 500 V4 injection mortar

Anchor design (EN 1992-4) / Rebar elements / Concrete

## Injection mortar system



Foil pack: HIT-RE 500 V4  
(Available in 330, 500 and 1400 ml cartridges)



Rebar B500  
( $\phi 8$  -  $\phi 40$ )

## Benefits

- **SafeSet** technology: Simplified method of borehole preparation using either Hilti hollow drill bit for hammer drilling or Roughening tool for diamond cored applications
- Suitable for non-cracked and cracked concrete C 20/25 to C 50/60
- ETA approval for seismic performance category C1
- ETA Data for 100y working life
- High loading capacity
- Suitable for dry and water saturated concrete
- Hilti Technical Data for under water application
- Long working time to allow installation of big diameters and/or deep embedment depths even at higher temperature
- Cures down to -5 °C

## Base material



Concrete (non-cracked)



Concrete (cracked)



Dry concrete

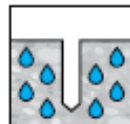

Wet concrete



Static/quasi-static



Seismic, ETA-C1

**100**  
YEARS

Working life 100y, ETA

## Load conditions

## Installation conditions

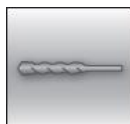

Hammer drilling



Diamond coring



Hilti **SafeSet** technology

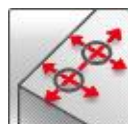

Small edge distance and spacing



European Technical Assessment



CE conformity



PROFIS Engineering design Software

## Other informations

## Approvals / certificates

Description	Authority / Laboratory	No. / date of issue
European technical Assessment <sup>a)</sup>	CSTB, Marne la Vallée	ETA-20/0541 / 2021-09-04

<sup>a)</sup> All data given in this section according to ETA-20/0541 issue 2021-09-04 (if not stated otherwise).



**Static and quasi-static loading (for a single anchor) – Working life 50 years**
**All data in this section applies to**

- Correct setting (see setting instruction)
- No edge distance and spacing influence
- Steel failure
- Rebar B500
- Base material thickness and embedment depth, as specified in the table
- Concrete C 20/25
- In-service temperature range I: -40 °C to +40 °C  
(min. base material temperature -40°C, max. long/short term base material temperature: +24°C/40°C)
- Short term loading. For long term loading apply  $\psi_{\text{sus}}$  acc. to EN 1992-4  
Hammer drilled holes, hammer drilled holes with hollow drill bit and diamond cored holes with Hilti roughening tool:  $\psi_{\text{sus}}^0 = 0,88$ ; diamond cored holes:  $\psi_{\text{sus}}^0 = 0,89$

**Embedment depth and base material thickness for static and quasi-static loading data**

Rebar size		ETA-20/0541, issued 2021-09-04											Hilti tech. data		
		φ8	φ10	φ12	φ14	φ16	φ18	φ20	φ24	φ25	φ28	φ30	φ32	φ36	φ40
Embedment depth	$h_{\text{ef}}$ [mm]	80	90	110	125	125	150	170	190	210	270	270	300	330	360
Base material thickness	$h$ [mm]	110	120	142	161	165	194	220	250	274	340	344	380	420	470

**For hammer drilled holes, hammer drilled holes with hollow drill bit<sup>1)</sup> and diamond cored with Hilti roughening tool TE-YRT<sup>2)</sup>:**
**Characteristic resistance**

Rebar size			ETA-20/0541, issued 2021-09-04											Hilti tech. data		
			φ8	φ10	φ12	φ14	φ16	φ18	φ20	φ24	φ25	φ28	φ30	φ32	φ36	φ40
<b>Non-cracked concrete</b>																
Tension	Rebar B500B	$N_{\text{Rk}}$ [kN]	20,1	42,0	56,8	68,8	68,8	90,4	109,0	128,8	149,7	218,2	218,2	255,6	294,9	336,0
Shear	Rebar B500B	$V_{\text{Rk}}$ [kN]	14,0	22,0	31,0	42,0	55,0	70,0	86,0	124,0	135,0	169,0	194,0	221,0	280,0	346,0
<b>Cracked concrete</b>																
Tension	Rebar B500B	$N_{\text{Rk}}$ [kN]	11,1	28,3	39,7	48,1	48,1	63,3	76,3	90,2	104,8	152,8	152,8	178,9	-	-
Shear	Rebar B500B	$V_{\text{Rk}}$ [kN]	14,0	22,0	31,0	42,0	55,0	70,0	86,0	124,0	135,0	169,0	194,0	221,0	-	-

<sup>1)</sup> Hilti hollow drill bit available for element size φ10-φ28.

<sup>2)</sup> Hilti Roughening tools are available for element size φ14-φ28.

**Design resistance**

Rebar size			ETA-20/0541, issued 2021-09-04											Hilti tech. data		
			φ8	φ10	φ12	φ14	φ16	φ18	φ20	φ24	φ25	φ28	φ30	φ32	φ36	φ40
<b>Non-cracked concrete</b>																
Tension	Rebar B500B	$N_{\text{Rd}}$ [kN]	13,4	28,0	37,8	45,8	45,8	60,2	72,7	85,9	99,8	145,5	145,5	170,4	163,8	186,7
Shear	Rebar B500B	$V_{\text{Rd}}$ [kN]	9,3	14,7	20,7	28,0	36,7	46,7	57,3	82,7	90,0	112,7	129,3	147,3	186,7	230,7
<b>Cracked concrete</b>																
Tension	Rebar B500B	$N_{\text{Rd}}$ [kN]	7,4	18,8	26,5	32,1	32,1	42,2	50,9	60,1	69,9	101,8	101,8	119,3	-	-
Shear	Rebar B500B	$V_{\text{Rd}}$ [kN]	9,3	14,7	20,7	28,0	36,7	46,7	57,3	82,7	90,0	112,7	129,3	147,3	-	-

**Recommended loads<sup>a)</sup>**

Rebar size			ETA-20/0541, issued 2021-09-04											Hilti tech. data		
			φ8	φ10	φ12	φ14	φ16	φ18	φ20	φ24	φ25	φ28	φ30	φ32	φ36	φ40
<b>Non-cracked concrete</b>																
Tension	Rebar B500B	$N_{\text{rec}}$ [kN]	9,6	20,0	27,0	32,7	32,7	43,0	51,9	61,4	71,3	103,9	103,9	121,7	117,0	133,3
Shear	Rebar B500B	$V_{\text{rec}}$ [kN]	6,7	10,5	14,8	20,0	26,2	33,3	41,0	59,0	64,3	80,5	92,4	105,2	133,3	164,8
<b>Cracked concrete</b>																
Tension	Rebar B500B	$N_{\text{rec}}$ [kN]	5,3	13,5	18,9	22,9	22,9	30,1	36,3	42,9	49,9	72,7	72,7	85,2	-	-
Shear	Rebar B500B	$V_{\text{rec}}$ [kN]	6,7	10,5	14,8	20,0	26,2	33,3	41,0	59,0	64,3	80,5	92,4	105,2	-	-

<sup>a)</sup> With overall partial safety factor for action  $\gamma=1,4$ . The partial safety factors for action depend on the type of loading and shall be taken from national regulations.

**For diamond cored holes:  
Characteristic resistance**

Rebar size			ETA-20/0541, issued 2021-09-04											
			φ8	φ10	φ12	φ14	φ16	φ18	φ20	φ24	φ25	φ28	φ30	φ32
<b>Non-cracked concrete</b>														
Tension	Rebar B500B	$N_{Rk}$ [kN]	19,1	26,9	39,4	52,2	59,7	80,5	101,4	128,8	149,7	218,2	218,2	255,6
Shear	Rebar B500B	$V_{Rk}$ [kN]	14,0	22,0	31,0	42,0	55,0	70,0	86,0	124,0	135,0	169,0	194,0	221,0

**Design resistance**

Rebar size			ETA-20/0541, issued 2021-09-04											
			φ8	φ10	φ12	φ14	φ16	φ18	φ20	φ24	φ25	φ28	φ30	φ32
<b>Non-cracked concrete</b>														
Tension	Rebar B500B	$N_{Rd}$ [kN]	10,6	14,9	21,9	29,0	28,4	38,4	48,3	61,4	71,3	103,9	103,9	121,7
Shear	Rebar B500B	$V_{Rd}$ [kN]	9,3	14,7	20,7	28,0	36,7	46,7	57,3	82,7	90,0	112,7	129,3	147,3

**Recommended loads<sup>a)</sup>**

Rebar size			ETA-20/0541, issued 2021-09-04											
			φ8	φ10	φ12	φ14	φ16	φ18	φ20	φ24	φ25	φ28	φ30	φ32
<b>Non-cracked concrete</b>														
Tension	Rebar B500B	$N_{rec}$ [kN]	7,6	10,7	15,6	20,7	20,3	27,4	34,5	43,8	50,9	74,2	74,2	86,9
Shear	Rebar B500B	$V_{rec}$ [kN]	6,7	10,5	14,8	20,0	26,2	33,3	41,0	59,0	64,3	80,5	92,4	105,2

<sup>a)</sup> With overall partial safety factor for action  $\gamma=1,4$ . The partial safety factors for action depend on the type of loading and shall be taken from national regulations.



**Static and quasi-static resistance (for a single anchor) - Working life 100 years**
**All data in this section applies to**

- Correct setting (see setting instruction)
- No edge distance and spacing influence
- Steel failure
- Base material thickness and one typical embedment depth, as specified in the table
- Concrete C 20/25
- In-service temperature range I: -40 °C to +40 °C  
(min. base material temperature -40 °C, max. long/short term base material temperature: +24 °C/40 °C)
- Short term loading. For long term loading apply  $\psi_{\text{sus}}$  acc. to EN 1992-4.

**Embedment depth and base material thickness for static and quasi-static loading data**

Rebar size			ETA-20/0541, issued 2021-09-04											
			φ8	φ10	φ12	φ14	φ16	φ18	φ20	φ24	φ25	φ28	φ30	φ32
Embedment depth	$h_{\text{ef}}$	[mm]	80	90	110	125	125	150	170	190	210	270	270	300
Base material thickness	$h$	[mm]	110	120	142	161	165	194	220	250	274	340	344	380

For hammer drilled holes, hammer drilled holes with hollow drill bit<sup>1)</sup> and diamond cored with Hilti roughening tool TE-YRT<sup>2)</sup>:

**Characteristic resistance**

Rebar size				ETA-20/0541, issued 2021-09-04											
				φ8	φ10	φ12	φ14	φ16	φ18	φ20	φ24	φ25	φ28	φ30	φ32
<b>Non-cracked concrete</b>															
Tension	Rebar B500B	$N_{\text{Rk}}$	[kN]	20,1	42,0	56,8	68,8	68,8	90,4	109,0	128,8	149,7	218,2	218,2	255,6
Shear	Rebar B500B	$V_{\text{Rk}}$	[kN]	14,0	22,0	31,0	42,0	55,0	70,0	86,0	124,0	135,0	169,0	194,0	221,0
<b>Cracked concrete</b>															
Tension	Rebar B500B	$N_{\text{Rk}}$	[kN]	10,1	25,4	39,7	48,1	48,1	63,3	76,3	90,2	104,8	152,8	152,8	178,9
Shear	Rebar B500B	$V_{\text{Rk}}$	[kN]	14,0	22,0	31,0	42,0	55,0	70,0	86,0	124,0	135,0	169,0	194,0	221,0

<sup>1)</sup> Hilti hollow drill bit available for element size φ10-φ28.

<sup>2)</sup> Hilti Roughening tools are available for element size φ14-φ28.

**Design resistance**

Rebar size				ETA-20/0541, issued 2021-09-04											
				φ8	φ10	φ12	φ14	φ16	φ18	φ20	φ24	φ25	φ28	φ30	φ32
<b>Non-cracked concrete</b>															
Tension	Rebar B500B	$N_{\text{Rd}}$	[kN]	13,4	28,0	37,8	45,8	45,8	60,2	72,7	85,9	99,8	145,5	145,5	170,4
Shear	Rebar B500B	$V_{\text{Rd}}$	[kN]	9,3	14,7	20,7	28,0	36,7	46,7	57,3	82,7	90,0	112,7	129,3	147,3
<b>Cracked concrete</b>															
Tension	Rebar B500B	$N_{\text{Rd}}$	[kN]	6,7	17,0	26,5	32,1	32,1	42,2	50,9	60,1	69,9	101,8	101,8	119,3
Shear	Rebar B500B	$V_{\text{Rd}}$	[kN]	9,3	14,7	20,7	28,0	36,7	46,7	57,3	82,7	90,0	112,7	129,3	147,3

**Recommended load<sup>a)</sup>**

Rebar size				ETA-20/0541, issued 2021-09-04											
				φ8	φ10	φ12	φ14	φ16	φ18	φ20	φ24	φ25	φ28	φ30	φ32
<b>Non-cracked concrete</b>															
Tension	Rebar B500B	$N_{\text{rec}}$	[kN]	9,6	20,0	27,0	32,7	32,7	43,0	51,9	61,4	71,3	103,9	103,9	121,7
Shear	Rebar B500B	$V_{\text{rec}}$	[kN]	6,7	10,5	14,8	20,0	26,2	33,3	41,0	59,0	64,3	80,5	92,4	105,2
<b>Cracked concrete</b>															
Tension	Rebar B500B	$N_{\text{rec}}$	[kN]	4,8	12,1	18,9	22,9	22,9	30,1	36,3	42,9	49,9	72,7	72,7	85,2
Shear	Rebar B500B	$V_{\text{rec}}$	[kN]	6,7	10,5	14,8	20,0	26,2	33,3	41,0	59,0	64,3	80,5	92,4	105,2

<sup>a)</sup> With overall partial safety factor for action  $\gamma=1,4$ . The partial safety factors for action depend on the type of loading and shall be taken from national regulations.

**For diamond cored holes:  
Characteristic resistance**

Rebar size			ETA-20/0541, issued 2021-09-04											
			φ8	φ10	φ12	φ14	φ16	φ18	φ20	φ24	φ25	φ28	φ30	φ32
<b>Non-cracked concrete</b>														
Tension	Rebar B500B	$N_{Rk}$ [kN]	19,1	26,9	39,4	52,2	59,7	80,5	101,4	128,8	149,7	218,2	218,2	255,6
Shear	Rebar B500B	$V_{Rk}$ [kN]	14,0	22,0	31,0	42,0	55,0	70,0	86,0	124,0	135,0	169,0	194,0	221,0

**Design resistance**

Rebar size			ETA-20/0541, issued 2021-09-04											
			φ8	φ10	φ12	φ14	φ16	φ18	φ20	φ24	φ25	φ28	φ30	φ32
<b>Non-cracked concrete</b>														
Tension	Rebar B500B	$N_{Rd}$ [kN]	10,6	14,9	21,9	29,0	28,4	38,4	48,3	61,4	71,3	103,9	103,9	121,7
Shear	Rebar B500B	$V_{Rd}$ [kN]	9,3	14,7	20,7	28,0	36,7	46,7	57,3	82,7	90,0	112,7	129,3	147,3

**Recommended load<sup>a)</sup>**

Rebar size			ETA-20/0541, issued 2021-09-04											
			φ8	φ10	φ12	φ14	φ16	φ18	φ20	φ24	φ25	φ28	φ30	φ32
<b>Non-cracked concrete</b>														
Tension	Rebar B500B	$N_{rec}$ [kN]	7,6	10,7	15,6	20,7	20,3	27,4	34,5	43,8	50,9	74,2	74,2	86,9
Shear	Rebar B500B	$V_{rec}$ [kN]	6,7	10,5	14,8	20,0	26,2	33,3	41,0	59,0	64,3	80,5	92,4	105,2

a) With overall partial safety factor for action  $\gamma=1,4$ . The partial safety factors for action depend on the type of loading and shall be taken from national regulations.

## Seismic loading (for a single anchor) - Working life 50 years

### All data in this section applies to:

- Correct setting (see setting)
- No edge distance and spacing influence
- Steel failure
- Base material thickness and embedment depth, as specified in the table
- Concrete C 20/25
- In-service temperate range I  
(min. base material temperature -40 °C, max. long term/short term base material temperature: +24 °C/40 °C)
- $\alpha_{\text{gap}} = 1,0$

### Embedment depth and base material thickness in case of seismic performance category C1

Rebar size			ETA-20/0541, issued 2021-09-04											
			$\phi 8$	$\phi 10$	$\phi 12$	$\phi 14$	$\phi 16$	$\phi 18$	$\phi 20$	$\phi 24$	$\phi 25$	$\phi 28$	$\phi 30$	$\phi 32$
Embedment depth	$h_{\text{ef}}$	[mm]	-	90	110	125	125	150	170	190	210	270	270	300
Base material thickness	$h$	[mm]	-	120	142	161	165	194	220	250	274	340	344	380

For hammer drilled holes, hammer drilled holes with hollow drill bit<sup>1)</sup> and diamond cored with Hilti roughening tool TE-YRT<sup>2)</sup>:

### Characteristic resistance in case of seismic performance category C1

Rebar size			ETA-20/0541, issued 2021-09-04											
			$\phi 8$	$\phi 10$	$\phi 12$	$\phi 14$	$\phi 16$	$\phi 18$	$\phi 20$	$\phi 24$	$\phi 25$	$\phi 28$	$\phi 30$	$\phi 32$
Tension	Rebar B500B	$N_{\text{Rk,seis}}$ [kN]	-	25,0	33,8	40,9	40,9	53,8	64,9	76,7	89,1	129,9	129,9	152,1
Shear	Rebar B500B	$V_{\text{Rk,seis}}$ [kN]	-	15,0	22,0	29,0	39,0	49,0	60,0	87,0	95,0	118,0	136,0	155,0

<sup>1)</sup> Hilti hollow drill bit available for element size  $\phi 10$ - $\phi 28$ .

<sup>2)</sup> Roughening tools are available for element size  $\phi 14$ - $\phi 28$ .

### Design resistance in case of seismic performance category C1

Rebar size			ETA-20/0541, issued 2021-09-04											
			$\phi 8$	$\phi 10$	$\phi 12$	$\phi 14$	$\phi 16$	$\phi 18$	$\phi 20$	$\phi 24$	$\phi 25$	$\phi 28$	$\phi 30$	$\phi 32$
Tension	Rebar B500B	$N_{\text{Rd,seis}}$ [kN]	-	16,7	22,5	27,3	27,3	35,8	43,3	51,1	59,4	86,6	86,6	101,4
Shear	Rebar B500B	$V_{\text{Rd,seis}}$ [kN]	-	10,0	14,7	20,0	26,0	32,7	40,0	58,0	63,3	78,7	90,7	103,3

## Materials

### Mechanical properties

Rebar size	φ8	φ10	φ12	φ14	φ16	φ18	φ20	φ24	φ25	φ28	φ30	φ32	φ36	φ40
Nominal tensile strength $f_{uk}$ [N/mm <sup>2</sup> ]	550	550	550	550	550	550	550	550	550	550	550	550	550	550
Yield strength $f_{yk}$ [N/mm <sup>2</sup> ]	500	500	500	500	500	500	500	500	500	500	500	500	500	500
Stressed cross-section $A_s$ [mm <sup>2</sup> ]	50,3	78,5	113	154	201	254	314	452	491	616	707	804	1018	1257
Moment of resistance $W$ [mm <sup>3</sup> ]	50,3	98,2	170	269	402	573	785	1357	1534	2155	2650	3217	4580	6283

### Material quality

Part	Material
Rebar EN 1992-1-1:2004 and AC:2010	Bars and de-coiled rods class B or C with $f_{yk}$ and $k$ according to NDP or NCL of EN 1992-1-1/ NA:2013 $f_{uk} = f_{tk} = k \cdot f_{yk}$

## Setting information

### Installation temperature range:

-5 °C to +40 °C

### Service temperature range

Hilti HIT-RE 500 V4 injection mortar may be applied in the temperature ranges given below. An elevated base material temperature may lead to a reduction of the design bond resistance.

Temperature range	Base material temperature	Maximum long term base material temperature	Maximum short term base material temperature
Temperature range I	-40 °C to +40 °C	+24 °C	+40 °C
Temperature range II	-40 °C to +55 °C	+43 °C	+55 °C
Temperature range III	-40 °C to +75 °C	+55 °C	+75 °C

### Maximum short term base material temperature

Short term elevated base material temperatures are those that occur over brief intervals, e.g. as a result of diurnal cycling.

### Maximum long term base material temperature

Long term elevated base material temperatures are roughly constant over significant periods of time.

### Working time and curing time

Temperature of the base material	Maximum working time	Minimum curing time
$T_{BM}^{2)}$	$t_{work}$	$t_{cure}^{1)}$
$-5\text{ °C} \leq T_{BM} < -1\text{ °C}$	2 h	168 h
$0\text{ °C} \leq T_{BM} < 4\text{ °C}$	2 h	48 h
$5\text{ °C} \leq T_{BM} < 9\text{ °C}$	2 h	24 h
$10\text{ °C} \leq T_{BM} < 14\text{ °C}$	1,5 h	16 h
$15\text{ °C} \leq T_{BM} < 19\text{ °C}$	1 h	12 h
$20\text{ °C} \leq T_{BM} < 24\text{ °C}$	30 min	7 h
$25\text{ °C} \leq T_{BM} < 29\text{ °C}$	20 min	6 h
$30\text{ °C} \leq T_{BM} < 34\text{ °C}$	15 min	5 h
$35\text{ °C} \leq T_{BM} < 39\text{ °C}$	12 min	4,5 h
$T_{BM} = 40\text{ °C}$	10 min	4 h

<sup>1)</sup> The curing time data are valid for dry base material only. In wet base material, the curing times must be doubled.

<sup>2)</sup> The minimum temperature of the foil pack is +5° C.

**Setting details**

Rebar size			ETA-20/0541, issued 2021-09-04											Hilti tech. data				
			φ8	φ10	φ12	φ14	φ16	φ18	φ20	φ24	φ25	φ28	φ30	φ32	φ36	φ40		
Nominal diameter of drill bit	$d_0$	[mm]	10 12 <sup>a)</sup>	12 14 <sup>a)</sup>	14 <sup>a)</sup>	16 <sup>a)</sup>	18	20	22	25	30 32 <sup>a)</sup>	30 32 <sup>a)</sup>	35	37	40	45	55	
Effective anchorage and drill hole depth range <sup>b)</sup>	$h_{ef,min} = h_0$	[mm]	60	60	70	70	75	80	85	90	100	100	112	120	128	144	160	
	$h_{ef,max} = h_0$	[mm]	160	200	240	240	280	320	360	400	480	500	560	600	640	720	800	
Minimum base material thickness	$h_{min}$	[mm]	$h_{ef} + 30\text{mm}$ $\geq 100\text{mm}$				$h_{ef} + 2 d_0$											
Minimum spacing	$s_{min}$	[mm]	40	50	60	60	70	80	90	100	125	125	140	150	160	180	200	
Minimum edge distance	$c_{min}$	[mm]	40	45	45	45	50	50	60	65	70	70	75	80	80	180	200	
Critical spacing for splitting failure	$s_{cr,sp}$	[mm]	$2 C_{cr,sp}$															
Critical edge distance for splitting failure <sup>c)</sup>	$c_{cr,sp}$	[mm]	$1,0 h_{ef}$			for $h / h_{ef} \geq 2,0$												
			$4,6 h_{ef} - 1,8 h$			for $2,0 > h / h_{ef} > 1,3$												
			$2,26 h_{ef}$			for $h / h_{ef} \leq 1,3$												
Critical spacing for concrete cone failure	$s_{cr,N}$	[mm]	$2 C_{cr,N}$															
Critical edge distance for concrete cone failure	$c_{cr,N}$	[mm]	$1,5 h_{ef}$															

For spacing (edge distance) smaller than critical spacing (critical edge distance) the design loads have to be reduced.

a) both given values for drill bit diameter can be used

b)  $h_{ef,min} \leq h_{ef} \leq h_{ef,max}$  ( $h_{ef}$ : embedment depth)

c)  $h$ : base material thickness ( $h \geq h_{min}$ )

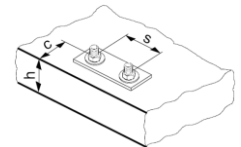
**Installation equipment**

Rebar size	φ8	φ10	φ12	φ14	φ16	φ18	φ20	φ24	φ25	φ28	φ30	φ32	φ36	φ40	
Rotary hammer	TE 2 (-A) – TE 40(-A)							TE40 – TE80							
Diamond coring tools	DD EC-1, DD 100 ... DD 160												-		
Other tools	Compressed air gun, set of cleaning brushes, hollow drill bit, roughening tool, dispenser, piston plug														

**Drilling and cleaning diameters**

Rebar size	Drilling		Diamond coring		Cleaning	Installation
	Hammer drill (HD)	Hollow Drill Bit (HDB) <sup>c)</sup>	Diamond coring (DD)	with roughening tool (RT)	Brush HIT-RB	Piston plug HIT-SZ
	d <sub>0</sub> [mm]				size [mm]	
φ8	12 (10 <sup>a)</sup> )	12	12 (10 <sup>a)</sup> )	-	12 (10 <sup>a)</sup> )	12
φ10	14 (12 <sup>a)</sup> )	14 (12 <sup>a)</sup> )	14 (12 <sup>a)</sup> )	-	14 (12 <sup>a)</sup> )	14 (12 <sup>a)</sup> )
φ12	16 (14 <sup>a)</sup> )	16 (14 <sup>a)</sup> )	16 (14 <sup>a)</sup> )	-	16 (14 <sup>a)</sup> )	16 (14 <sup>a)</sup> )
φ14	18	18	18	18	18	18
φ16	20	20	20	20	20	20
φ20	25	25	25	25	25	25
φ25	32	32	32	32	32	32
φ28	35	35	35	35	35	35
φ30	37	-	37	-	37	37
φ32	40	-	-	-	40	40
	-	-	42	-	42	42
φ36 <sup>b)</sup>	45 <sup>b)</sup>	-	-	-	45 <sup>b)</sup>	45 <sup>b)</sup>
φ40 <sup>b)</sup>	55 <sup>b)</sup>	-	-	-	55 <sup>b)</sup>	55 <sup>b)</sup>

a) Each of two given values can be used

b) Additional Hilti technical data.

c) No. cleaning required.

**Associated components for the use of Hilti Roughening tool TE-YRT**

Diamond coring		Roughening tool TE-YRT	Wear gauge RTG...
d <sub>0</sub> [mm]		d <sub>0</sub> [mm]	size
nominal	measured		
18	17,9 to 18,2	18	18
20	19,9 to 20,2	20	20
22	21,9 to 22,2	22	22
25	24,9 to 25,2	25	25
28	27,9 to 28,2	28	28
30	29,9 to 30,2	30	30
32	31,9 to 32,2	32	32
35	34,9 to 35,2	35	35

**Minimum roughening time t<sub>roughen</sub> (t<sub>roughen</sub> [sec] = h<sub>ef</sub> [mm] / 10)**

h <sub>ef</sub> [mm]	t <sub>roughen</sub> [sec]
0 to 100	10
101 to 200	20
201 to 300	30
301 to 400	40
401 to 500	50
501 to 600	60

## Setting instructions

\*For detailed information on installation see instruction for use given with the package of the product.



### Safety regulations.

Review the Material Safety Data Sheet (MSDS) before use for proper and safe handling! Wear well-fitting protective goggles and protective gloves when working with Hilti HIT-RE 500 V4.

## Drilling

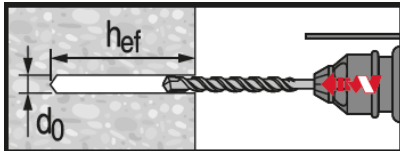

**Hammer drilled hole**

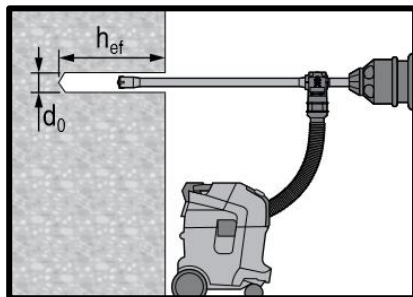

**Hammer drilled hole with Hollow Drilled Bit (HDB)**

No cleaning required

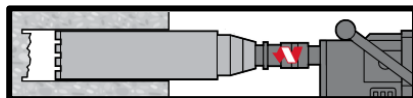

**Diamond Coring**

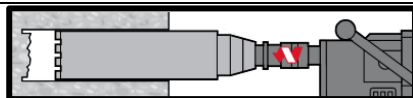

**Diamond Coring + Roughening Tool**

For dry and wet concrete only.  
Before roughening, the borehole needs to be dry.

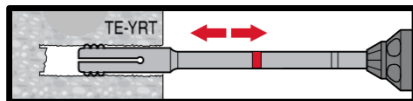

## Cleaning (Inadequate hole cleaning=poor load values.)

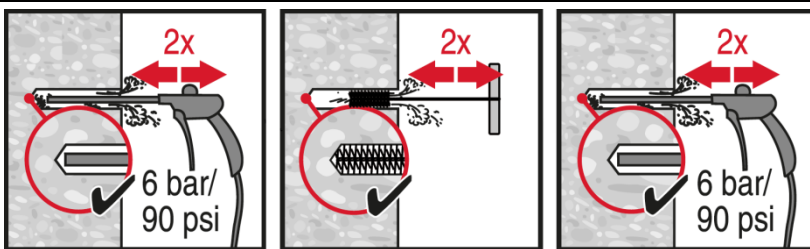

**Hammer Drilling:**

### Compressed air cleaning (CAC)

for all drill hole diameters  $d_0$  and drill hole depths  $h_0 \leq 20 \cdot d$ .

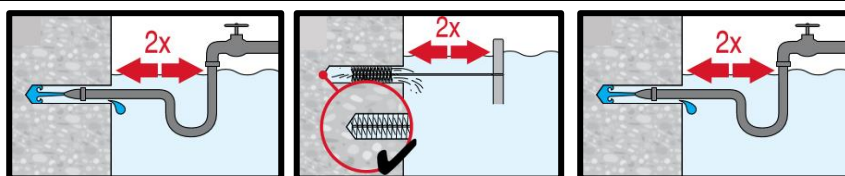

**Hammer drilling:**

### Cleaning for under water:

For all bore hole diameters  $d_0$  and all bore hole depth  $h_0$ .

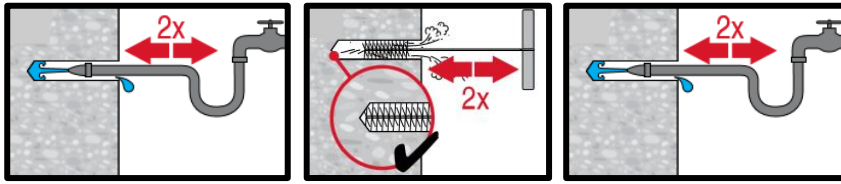
**Hammer drilled flooded holes and diamond cored holes:**

For all drill hole diameters  $d_0$  and drill hole depths  $h_0$ .

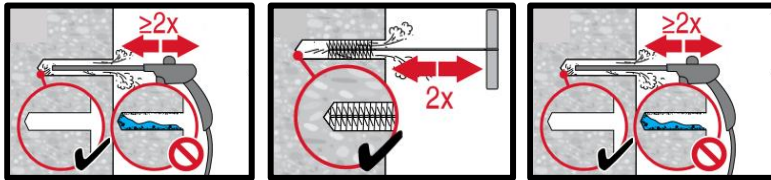
**Diamond cored holes with Hilti roughening tool:**

For all drill hole diameters  $d_0$  and drill hole depths  $h_0$ .

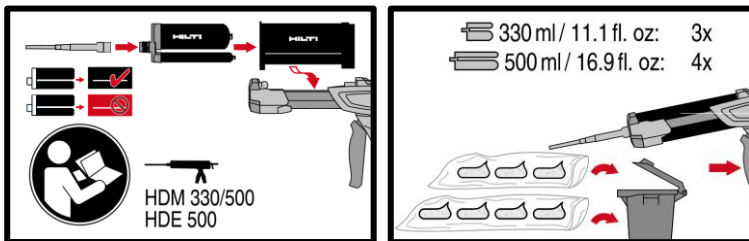
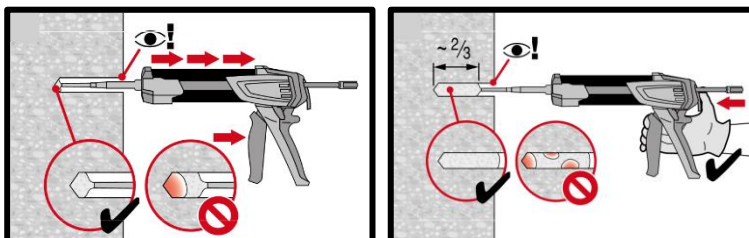
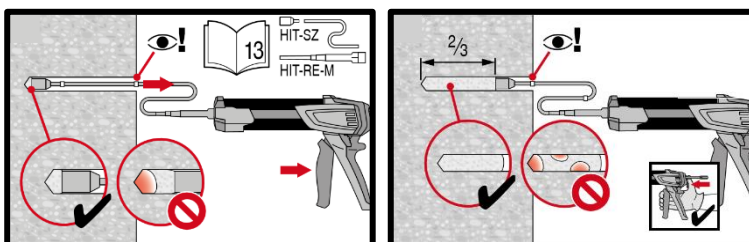
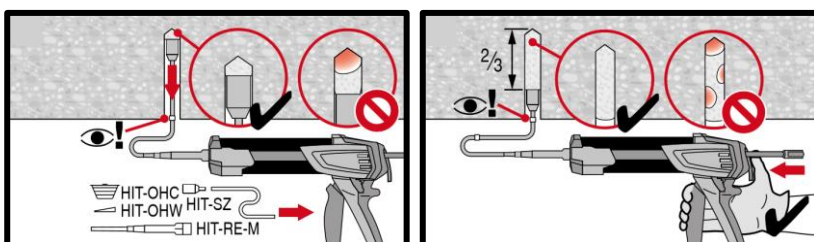
**Injection preparation**

**Injection system preparation.**

**Injection method for drill hole depth  $h_{ef} \leq 250$  mm.**

**Injection method for drill hole depth  $h_{ef} > 250$  mm.**

**Injection method for overhead application.**

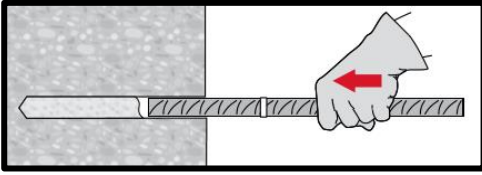

---

**Setting the element**

---



**Setting element**, observe working time " $t_{work}$ ".

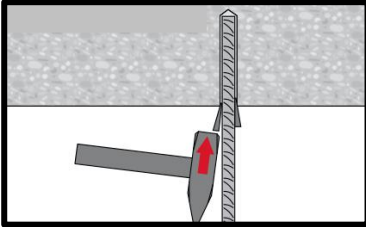

**Setting element** for overhead applications, observe working time " $t_{work}$ ".

---

**Loading the anchor:** After required curing time  $t_{cure}$  the anchor can be loaded.

---

# HIT-RE 500 V4 injection mortar

Rebar design (EN 1992-1-1, EOTA TR 069) / Rebar elements / Concrete

## Injection mortar system



Foil pack: HIT-RE 500 V4  
(available in 330, 500 and 1400 ml cartridges)



Rebar  
( $\phi 8$  -  $\phi 40$ )

## Benefits

- **SafeSet** technology: Simplified method of borehole preparation using either Hilti hollow drill bit for hammer drilling or Roughening tool for diamond cored applications
- Allows the design of post-installed, moment-resisting reinforced concrete connections under static loading conditions without using a splice configuration according to TR 069
- Suitable for concrete C 12/15 to C 50/60
- ETA Data for 100 years working life
- High loading capacity
- Suitable for dry and water saturated concrete
- Non-corrosive to rebar elements
- Long working time at elevated temperatures
- Cures down to  $-5\text{ }^{\circ}\text{C}$
- Odourless epoxy

## Base material



Concrete (non-cracked)



Concrete (cracked)



Dry concrete

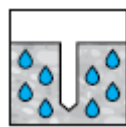

Wet concrete

## Load conditions



Static/  
quasi-static



Seismic



Fire  
resistance

**100**  
YEARS

Working life  
100 years,

## Installation conditions

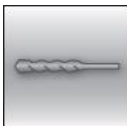

Hammer  
drilling



Diamond  
coring



Hilti **SafeSet**  
technology

## Other informations



European  
Technical  
Assessment



CE  
conformity



PROFIS  
Engineering  
design  
Software

## Approvals / certificates

Description	Authority / Laboratory	No. / date of issue
European technical assessment <sup>a)</sup>	CSTB, Marne la Vallée	ETA-20/0539 / 2022-07-05
European technical assessment <sup>b)</sup>	CSTB, Marne la Vallée	ETA-20/0540 / 2021-07-09
Allgemeine Bauartgenehmigung	DIBt, Berlin	Z-21.8-2123 / 2021-01-28
Engineering Judgement (120-y working life based on EAD 330087-01-0601)	BERMEIGSTER, Vienna	No.: 07/2021
Engineering Judgement (120-y working life based on EAD 332402-00-0601-v01)	BERMEIGSTER, Vienna	No.: 04/2022

<sup>a)</sup> All data given in this section according to ETA-20/0539 issue 2022-07-05 (if not stated otherwise).

<sup>b)</sup> All data given in this section according to ETA-20/0540 issue 2022-07-09 (if not stated otherwise).

**Static and quasi-static loading**
**Static design acc. to EN 1992-1-1**

 Design bond strength in N/mm<sup>2</sup> for good bond conditions for service life of 50 and 100 years<sup>1)</sup>

 For hammer drilled holes, hammer drilled holes with hollow drill bit<sup>2)</sup> and diamond cored with Hilti roughening tool TE-YRT<sup>3)</sup>:

Rebar size	ETA 20/0540, issued 2021-07-09								
	Concrete class								
	C12/15	C16/20	C20/25	C25/30	C30/37	C35/45	C40/50	C45/55	C50/60
φ8 - φ32	1,6	2,0	2,3	2,7	3,0	3,4	3,7	4,0	4,3
φ34	1,6	2,0	2,3	2,6	2,9	3,3	3,6	3,9	4,2
φ36	1,6	1,9	2,2	2,6	2,9	3,2	3,5	3,8	4,1
φ40	1,5	1,8	2,1	2,5	2,8	3,1	3,4	3,7	3,9

- 1) For poor bond conditions multiply the values by 0,7.  
 2) Hilti hollow drill bit available for element size φ10-φ28.  
 3) Roughening tools are available for element size φ14-φ28.

**For diamond cored holes (wet):**

Rebar size	ETA 20/0540, issued 2021-07-09								
	Concrete class								
	C12/15	C16/20	C20/25	C25/30	C30/37	C35/45	C40/50	C45/55	C50/60
φ8 - φ12	1,6	2,0	2,3	2,7	3,0	3,4	3,7	4,0	4,0
φ14 - φ16	1,6	2,0	2,3	2,7	3,0	3,4	3,7	3,7	3,7
φ18 - φ32	1,6	2,0	2,3	2,7	3,0	3,4	3,4	3,4	3,4
φ34	1,6	2,0	2,3	2,6	2,9	3,3	3,3	3,3	3,3
φ36	1,6	1,9	2,2	2,6	2,9	3,2	3,2	3,2	3,2
φ40	1,5	1,8	2,1	2,5	2,8	2,8	2,8	2,8	2,8

- 1) For poor bond conditions multiply the values by 0,7.

**Increasing factors in concrete**

Drilling method	Concrete class	ETA 20/0540, issued 2021-07-09											
		Rebar size											
		φ8	φ10	φ12	φ14	φ16	φ20	φ25	φ28	φ30	φ32	φ36	φ40
Hammer drilled holes	C30/37	1,04											
Hammer drilled holes with hollow drill bit	C40/50	1,07											
Diamond cored holes	C50/60	1,09											
Diamond cored holes with roughening tool	C30/37 - C50/60	-				1,0				-			

**Minimum anchorage length and minimum lap length**

 The minimum anchorage length  $\ell_{b,min}$  and the minimum lap length  $\ell_{0,min}$  according to EN 1992-1-1 shall be multiplied by relevant **Amplification factor**  $\alpha_{lb}$  in the table below.

**Amplification factor  $\alpha_{lb}$  for the min. anchorage length and min. lap length:**

 Hammer drilled holes, hammer drilled holes with hollow drill bit<sup>1)</sup> and diamond cored with Hilti roughening tool TE-YRT<sup>2)</sup>

Rebar size	ETA 20/0540, issued 2021-07-09								
	Concrete class								
	C12/15	C16/20	C20/25	C25/30	C30/37	C35/45	C40/50	C45/55	C50/60
φ8 - φ40	1,0								

- 1) Hilti hollow drill bit available for element size φ10-φ28.  
 2) Roughening tools are available for element size φ14-φ28.

**Diamond cored holes (wet)**

Rebar size	ETA 20/0540, issued 2021-07-09								
	Concrete class								
	C12/15	C16/20	C20/25	C25/30	C30/37	C35/45	C40/50	C45/55	C50/60
φ8 - φ12	1,0								
φ14 - φ36	Linear interpolation between diameters								
φ40	1,0	1,0	1,0	1,0	1,2	1,3	1,4	1,4	1,4

**Anchorage length for characteristic steel strength  $f_{yk} = 500 \text{ N/mm}^2$  for good conditions**

Hammer drilling							
Rebar-size	Concrete class	$f_{bd}$	$l_{0,min}^{1)}$	$l_{b,min}^{2)}$	$l_{bd,y,\alpha_2=1}^{3)}$	$l_{bd,y,\alpha_2=0.7}^{4)}$	$l_{max}^{5)}$
		[N/mm <sup>2</sup> ]	[mm]	[mm]	[mm]	[mm]	[mm]
φ8	C20/25	2,3	200	113	378	265	1000
	C50/60	4,3	200	100	202	142	1000
φ10	C20/25	2,3	213	142	473	331	1000
	C50/60	4,3	200	100	253	177	1000
φ12	C20/25	2,3	255	170	567	397	1200
	C50/60	4,3	200	120	303	212	1200
φ14	C20/25	2,3	298	198	662	463	1400
	C50/60	4,3	210	140	354	248	1400
φ16	C20/25	2,3	340	227	756	529	1600
	C50/60	4,3	240	160	404	283	1600
φ20	C20/25	2,3	425	284	945	662	2000
	C50/60	4,3	300	200	506	354	2000
φ25	C20/25	2,3	532	354	1181	827	2500
	C50/60	4,3	375	250	632	442	2500
φ28	C20/25	2,3	595	397	1323	926	2800
	C50/60	4,3	420	280	708	495	2800
φ30	C20/25	2,3	638	425	1418	992	3000
	C50/60	4,3	450	300	758	531	3000
φ32	C20/25	2,3	681	454	1512	1059	3200
	C50/60	4,3	480	320	809	566	3200
φ36	C20/25	2,2	800	534	1779	1245	3200
	C50/60	4,1	540	360	954	668	3200
φ40	C20/25	2,1	932	621	2070	1449	3200
	C50/60	3,9	600	400	1115	780	3200

 1) Minimum anchorage length for overlap join in case of:  $\alpha_6 = 1,5$ 

2) Minimum anchorage length for simply supported connections

 3) Anchorage length for simply supported connections in case of:  $\alpha_1 = \alpha_2 = \alpha_3 = \alpha_4 = \alpha_5 = 1$ . - (design for yielding)

 4) Anchorage length for simply supported connections in case of:  $\alpha_1 = \alpha_3 = \alpha_4 = \alpha_5 = 1$ ;  $\alpha_2 = 0.7$  - (design for yielding)

5) Maximum feasible embedment depth due to mortar installation limitations.

## Static design acc. to EOTA TR 069

Design parameter for working life of 50 and 100 years<sup>1)</sup>

For hammer drilled holes, hammer drilled holes with hollow drill bit<sup>2)</sup> and diamond cored with Hilti roughening tool TE-YRT<sup>3)</sup>:

Rebar size		ETA 20/0539, issued 2022-07-05															
		φ8	φ10	φ12	φ13	φ14	φ16	φ18	φ20	φ22	φ24	φ25	φ28	φ30	φ32	φ36	φ40
<b>Combined pullout and concrete cone failure in non-cracked concrete C20/25</b>																	
Characteristic resistance $\tau_{Rk,ucr}$	[N/mm <sup>2</sup> ]	10	15	15	15	15	15	14	14	14	14	14	14	13	13	12	11
Characteristic resistance $\tau_{Rk,100,ucr}$	[N/mm <sup>2</sup> ]	10	15	15	15	15	15	14	14	14	14	14	14	13	13	12	11
<b>Bond-splitting failure</b>																	
Product basic factor $A_k$	[-]	4,4															
Exponent for influence of concrete compressive strength $sp_1$	[-]	0,29															
Exponent for influence of rebar diameter $\phi$ $sp_2$	[-]	0,27															
Exponent for influence of concrete cover $sp_3$	[-]	0,68															
Exponent for influence of side concrete cover $sp_4$	[-]	0,35															
Exponent for influence of anchorage length $l_{b1}$	[-]	0,60															
<b>Influence of cracked concrete on combined pullout and concrete cone failure</b>																	
Factor for influence of cracked concrete $\Omega_{cr}$	[-]	1,00	0,96	0,90	0,88	0,85	0,82	0,78	0,76	0,73	0,71	0,70	0,68	0,66	0,65	0,62	0,60

<sup>1)</sup> Temperate range I: (min. base material temperature -40°C, max. long term/short term base material temperature: +24°C/40°C).

<sup>2)</sup> Hilti hollow drill bit available for element size φ10-φ28.

<sup>3)</sup> Hilti Roughening tools are available for element size φ14-φ28.

### For diamond coring:

Rebar size		ETA 20/0539, issued 2022-07-05															
		φ8	φ10	φ12	φ13	φ14	φ16	φ18	φ20	φ22	φ24	φ25	φ28	φ30	φ32	φ36	φ40
<b>Combined pullout and concrete cone failure in non-cracked concrete C20/25</b>																	
Characteristic resistance $\tau_{Rk,ucr}$	[N/mm <sup>2</sup> ]	9,5	9,5	9,5	9,5	9,5	9,5	9,5	9,5	9,5	9,5	9,5	10	10	10	2)	
Characteristic resistance $\tau_{Rk,100,ucr}$	[N/mm <sup>2</sup> ]	9,5	9,5	9,5	9,5	9,5	9,5	9,5	9,5	9,5	9,5	9,5	10	10	10	2)	
<b>Bond-splitting failure</b>																	
Product basic factor $A_k$	[-]	4,4															2)
Exponent for influence of concrete compressive strength $sp_1$	[-]	0,26															2)
Exponent for influence of rebar diameter $\phi$ $sp_2$	[-]	0,25															2)
Exponent for influence of concrete cover $sp_3$	[-]	0,52															2)
Exponent for influence of side concrete cover $sp_4$	[-]	0,26															2)
Exponent for influence of anchorage length $l_{b1}$	[-]	0,65															2)
<b>Influence of cracked concrete on combined pullout and concrete cone failure</b>																	
Factor for influence of cracked concrete $\Omega_{cr}$	[-]	0,5															2)

<sup>1)</sup> Temperate range I: (min. base material temperature -40°C, max. long term/short term base material temperature: +24°C/40°C);

<sup>2)</sup> No performance assessed

**Seismic loading**
**Seismic design acc. to EN 1998-1**

 Design bond strength according to in N/mm<sup>2</sup> for good bond conditions for working life of 50 and 100 years<sup>1)</sup>

 For hammer drilled holes, hammer drilled holes with hollow drill bit<sup>2)</sup> and diamond cored with Hilti roughening tool TE-YRT<sup>3)</sup>:

Rebar size	ETA-20/0540, issued 2021-07-09							
	Concrete class							
	C16/20	C20/25	C25/30	C30/37	C35/45	C40/50	C45/55	C50/60
φ8 - φ32	2,0	2,3	2,7	3,0	3,4	3,7	4,0	4,3
φ34	2,0	2,3	2,6	2,9	3,3	3,6	3,9	4,2
φ36	1,9	2,2	2,6	2,9	3,2	3,5	3,8	4,1
φ40	1,8	2,1	2,5	2,8	3,1	3,4	3,7	3,9

<sup>1)</sup> For poor bond conditions multiply the values by 0,7.

<sup>2)</sup> Hilti hollow drill bit available for element size φ10-φ28.

<sup>3)</sup> Hilti Roughening tools are available for element size φ14-φ28.

**For diamond cored holes:**

Rebar size	ETA-20/0540, issued 2021-07-09							
	Concrete class							
	C16/20	C20/25	C25/30	C30/37	C35/45	C40/50	C45/55	C50/60
φ12	2,0	2,3	2,7	3,0	3,4	3,7	4,0	4,0
φ13 - φ32	2,0	2,3	2,7	3,0	3,3	3,4	3,4	3,4
φ34	1,9	2,3	2,3	2,3	2,3	2,3	2,3	2,3
φ36	1,9	2,2	2,2	2,2	2,2	2,2	2,2	2,2
φ40	1,8	2,1	2,1	2,1	2,1	2,1	2,1	2,1

<sup>1)</sup> For poor bond conditions multiply the values by 0,7.

**Seismic design acc. to EOTA TR 069**

 Design parameter under seismic action for working life of 50 and 100 years<sup>1)</sup>

 For hammer drilled holes, hammer drilled holes with hollow drill bit<sup>2)</sup>

Rebar size	ETA 20/0539, issued 2022-07-05																
	φ8	φ10	φ12	φ13	φ14	φ16	φ18	φ20	φ22	φ24	φ25	φ28	φ30	φ32	φ36	φ40	
<b>Pull-out failure</b>																	
Reduction factor for pull-out resistance under seismic action $\alpha_{eq,p}$	[-]	0,61														0,65	
<b>Influence of cracked concrete on bond resistance <math>\tau_{Rd}</math></b>																	
Factor for influence of cracked concrete $\Omega_{cr,03}$	[-]	1,00	0,96	0,90	0,88	0,85	0,82	0,78	0,76	0,73	0,71	0,70	0,68	0,66	0,65	0,62	0,60
Factor for influence of cracked concrete $\Omega_{cr,05}$	[-]	0,79	0,81	0,82	0,83	0,84	0,82	0,78	0,76	0,73	0,71	0,70	0,68	0,66	0,65	0,62	0,60
Factor for influence of cracked concrete $\Omega_{cr,08}$	[-]	0,59	0,61	0,63	0,64	0,65	0,67	0,69	0,71	0,72	0,71	0,70	0,68	0,66	0,65	0,62	0,60
<b>Bond-splitting failure</b>																	
Reduction factor for bond-splitting resistance under seismic action $\alpha_{eq,sp}$	[-]																0,95

<sup>1)</sup> For poor bond conditions multiply the values by 0,7.

<sup>2)</sup> Hilti hollow drill bit available for element size φ10-φ28.

**Fire resistance**

**Temperature reduction factor  $k_{fi}(\theta)$  for concrete class C20/25 for good bond conditions according to ETA-20/0540 for working life of 50 and 100 years<sup>1)</sup>**

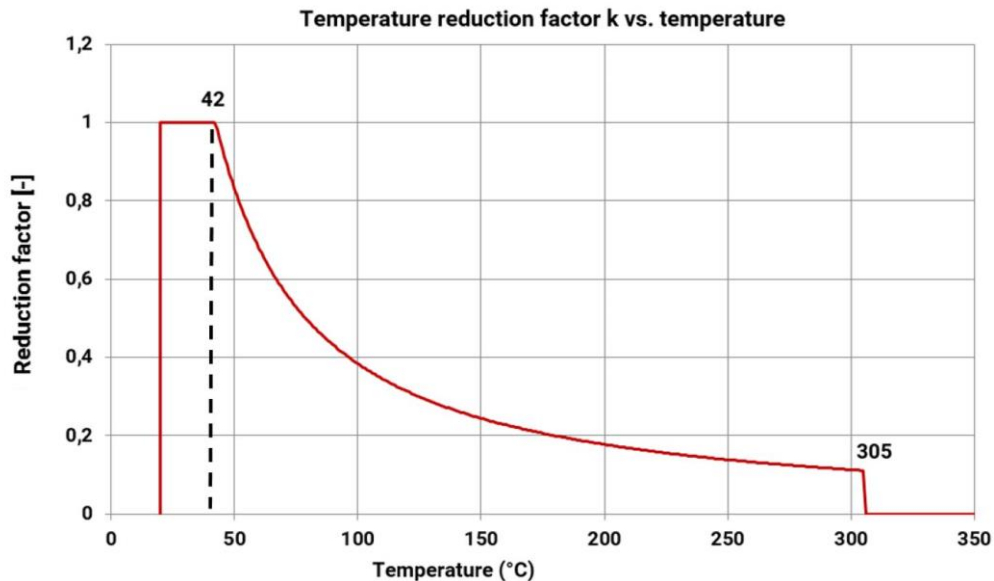

The design value of the bond resistance  $f_{bd,fi}$  under fire exposure has to be calculated by the following equation:

$$f_{bd,fi} = k_{b,fi}(\theta) \cdot f_{bd,PIR} \cdot \frac{\gamma_c}{\gamma_{M,fi}} \quad \text{for a working life of 50 years}$$

$$f_{bd,fi,100y} = k_{b,fi,100y}(\theta) \cdot f_{bd,PIR,100y} \cdot \frac{\gamma_c}{\gamma_{M,fi}} \quad \text{for a working life of 100 years}$$

with  $\theta \leq 305^\circ\text{C}$ :  $k_{b,fi}(\theta) = \frac{651,24 \cdot \theta^{-1,115}}{f_{bd,PIR} \cdot 4,3} \leq 1,0$  for a working life of 50 years

$$k_{b,fi,100y}(\theta) = \frac{651,24 \cdot \theta^{-1,115}}{f_{bd,PIR,100y} \cdot 4,3} \leq 1,0 \quad \text{for a working life of 100 years}$$

$$\theta > 305^\circ\text{C}: \quad k_{b,fi}(\theta) = k_{b,fi,100y}(\theta) = 0,0$$

$f_{bd,fi,50y}$  = Design value of the bond resistance in case of fire in N/mm<sup>2</sup> (service life 50 years).

$f_{bd,fi,100y}$  = Design value of the bond resistance in case of fire in N/mm<sup>2</sup> (service life 100 years).

$(\theta)$  = Temperature in °C in the mortar layer.

$k_{b,fi}(\theta)$  = Reduction factor under fire exposure.

$k_{b,fi,100y}(\theta)$  = Reduction factor under fire exposure for a working life of 100 years.

$f_{bd,PIR}$  = Design value of the bond resistance in N/mm<sup>2</sup> in cold condition according to Table C3 or C6 of ETA 20/0540 considering the concrete classes, the rebar diameter, the drilling method and the bond conditions according to EN 1992-1-1.

$f_{bd,PIR,100y}$  = Design value of the bond strength in N/mm<sup>2</sup> in cold condition according to Table C3 or Table C6 considering the concrete classes, the rebar diameter, the drilling method and the bond conditions according to EN 1992-1-1 for a working life of 100 years.

$\gamma_c$  = Partial safety factor according to EN 1992-1-1

$\gamma_{M,fi}$  = Partial safety factor according to EN 1992-1-2

For evidence under fire exposure the anchorage length shall be calculated according to EN 1992-1-1:2004+AC:2010 Equation 8.3 using the temperature-dependent bond resistance  $f_{bd,fi}$ .

## Materials

### Mechanical properties

Rebar size		φ8	φ10	φ12	φ13	φ14	φ16	φ18	φ20	φ24	φ25	φ28	φ30	φ32	φ36	φ40
Nominal tensile strength $f_{uk}$	$\sqrt{\text{mm}^2}$	550	550	550	550	550	550	550	550	550	550	550	550	550	550	550
Yield strength $f_{yk}$	$\sqrt{\text{mm}^2}$	500	500	500	500	500	500	500	500	500	500	500	500	500	500	500
Stressed cross-section $A_s$	$[\text{mm}^2]$	50,3	78,5	113	133	154	201	254	314	452	491	616	707	804	1018	1257
Moment of resistance $W$	$[\text{mm}^3]$	50,3	98,2	170	216	269	402	573	785	1357	1534	2155	2650	3217	4580	6283

### Material quality

Part	Material
Rebar EN 1992-1-1:2004 and AC:2010	Bars and de-coiled rods class B or C with $f_{yk}$ and $k$ according to NDP or NCL of EN 1992-1-1/ NA:2013 $f_{uk} = f_{tk} = k \cdot f_{yk}$

### Fitness for use

Some creep tests have been conducted in accordance with EAD 330087 in the following conditions: **in dry environment at 50 °C during 90 days.**

These tests show an excellent behaviour of the post-installed connection made with HIT-RE 500 V4: low displacements with long term stability, failure load after exposure above reference load.

### Resistance to chemical substances

Chemicals tested	Content (%)	Resistance	Chemical tested	Content (%)	Resistance
Toluene	47,5	+	Sodium hydroxide 20%	100	-
Iso-octane	30,4	+	Triethanolamine	50	-
Heptane	17,1	+	Butylamine	50	-
Methanol	3	+	Benzyl alcohol	100	-
Butanol	2	+	Ethanol	100	-
Toluene	60	+	Ethyl acetate	100	-
Xylene	30	+	Methyl ethyl ketone (MEK)	100	-
Methylnaphthalene	10	+	Trichlorethylene	100	-
Diesel	100	+	Lutensit TC KLC 50	3	+
Petrol	100	+	Marlophen NP 9,5	2	+
Methanol	100	-	Water	95	+
Dichloromethane	100	-	Tetrahydrofurane	100	-
Mono-chlorobenzene	100	o	Demineralized water	100	+
Ethylacetat	50	+	Salt water	saturated	+
Methylisobutylketone	50	+	Salt spray testing	-	+
Salicylic acid-	50	+	SO <sub>2</sub>	-	+
Acetophenon	50	+	Enviroment/wheather	-	+
Acetic acid	50	-	Oil for formwork (forming oil)	100	+
Propionic acid	50	-	Concentrate plasticizer	-	+
Sulfuric acid	100	-	Concrete potash solution	-	+
Nitric acid	100	-	Concrete potash solution	-	+
Hydrochloric acid	36	-	Saturated suspension of borehole cuttings	-	+
Potassium hydroxide	100	-			

- + Resistant
- Not resistant
- o Partially Resistant



## Setting information

### Installation temperature range

-5 °C to +40 °C

### Service temperature range

Hilti HIT-RE 500 V4 injection mortar may be applied in the temperature ranges given below. An elevated base material temperature may lead to a reduction of the design bond resistance.

#### ETA-20/0540

Temperature range	Base material temperature	Maximum long term base material temperature	Maximum short term base material temperature
Temperature range I	-40 °C to +80 °C	+50 °C	+80 °C

#### ETA-20/0539

Temperature range	Base material temperature	Maximum long term base material temperature	Maximum short term base material temperature
Temperature range I	-40 °C to +40 °C	+24 °C	+40 °C
Temperature range II	-40 °C to +55 °C	+43 °C	+55 °C
Temperature range III	-40 °C to +75 °C	+55 °C	+75 °C

### Maximum short term base material temperature

Short-term elevated base material temperatures are those that occur over brief intervals, e.g. as result of diurnal cycling.

### Maximum long term base material temperature

Long-term elevated base material temperatures are roughly constant over significant periods of time.

### Working time and curing time<sup>1)</sup>

Temperature of the base material	Maximum working time	Initial curing time	Minimum curing time
$T_{BM}^{2)}$	$t_{work}$	$t_{cure,ini}$	$t_{cure}$
$5\text{ °C} \leq T_{BM} < -1\text{ °C}$	2 h	48 h	168 h
$0\text{ °C} \leq T_{BM} < 4\text{ °C}$	2 h	24 h	48 h
$5\text{ °C} \leq T_{BM} < 9\text{ °C}$	2 h	16 h	24 h
$10\text{ °C} \leq T_{BM} < 14\text{ °C}$	1,5 h	12 h	16 h
$15\text{ °C} \leq T_{BM} < 19\text{ °C}$	1 h	8 h	16 h
$20\text{ °C} \leq T_{BM} < 24\text{ °C}$	30 min	4 h	7 h
$25\text{ °C} \leq T_{BM} < 29\text{ °C}$	20 min	3,5 h	6 h
$30\text{ °C} \leq T_{BM} < 34\text{ °C}$	15 min	3 h	5 h
$35\text{ °C} \leq T_{BM} < 39\text{ °C}$	12 min	2 h	4,5 h
$T_{BM} = 40\text{ °C}$	10 min	2 h	4 h

<sup>1)</sup> The curing time data are valid for dry base material only. In wet base material, the curing times must be doubled.

<sup>2)</sup> The minimum temperature of the foil pack is +5° C.

**Installation equipment**

Rebar size	φ8	φ10	φ12	φ13	φ14	φ16	φ18	φ20	φ24	φ25	φ28	φ32	φ34	φ36	φ40	
Rotary hammer	TE 2 (-A)– TE 40(-A)						TE40 – TE80									
Other tools	Blow out pump ( $h_{ef} \leq 10 \cdot d$ )						-									
	Compressed air gun <sup>a)</sup> Set of cleaning brushes <sup>b)</sup> , dispenser, piston plug Roughening tools															

a) Compressed air gun with extension hose for all drill holes deeper than 250 mm (for φ 8 to φ 12) or deeper than  $20 \cdot \phi$  (for φ > 12 mm).

b) Automatic brushing with round brush for all drill holes deeper than 250 mm (for φ 8 to φ 12) or deeper than  $20 \cdot \phi$  (for φ > 12 mm).

**Minimum concrete cover  $c_{min}$  of the post-installed rebar**

Drilling method	Rebar size	Minimum concrete cover $c_{min}$ [mm]	
		Without drilling aid	With drilling aid
Hammer drilling (HD) and (HDB)	$\phi < 25$	$30 + 0,06 \cdot l_v \geq 2 \cdot \phi$	$30 + 0,02 \cdot l_v \geq 2 \cdot \phi$
	$\phi \geq 25$	$40 + 0,06 \cdot l_v \geq 2 \cdot \phi$	$40 + 0,02 \cdot l_v \geq 2 \cdot \phi$
Compressed air drilling (CA)	$\phi < 25$	$50 + 0,08 \cdot l_v$	$50 + 0,02 \cdot l_v$
	$\phi \geq 25$	$60 + 0,08 \cdot l_v \geq 2 \cdot \phi$	$60 + 0,02 \cdot l_v \geq 2 \cdot \phi$
Diamond coring in wet (PCC) dry (DD)	$\phi < 25$	Drill stand works like a drilling aid	$30 + 0,02 \cdot l_v \geq 2 \cdot \phi$
	$\phi \geq 25$		$40 + 0,02 \cdot l_v \geq 2 \cdot \phi$
Diamond coring with Roughening tool TE-YRT (RT)	$\phi < 25$	$30 + 0,06 \cdot l_v \geq 2 \cdot \phi$	$30 + 0,02 \cdot l_v \geq 2 \cdot \phi$
	$\phi \geq 25$	$40 + 0,06 \cdot l_v \geq 2 \cdot \phi$	$40 + 0,02 \cdot l_v \geq 2 \cdot \phi$

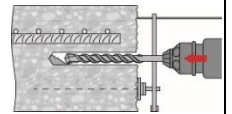
**Dispenser and corresponding maximum embedment depth  $l_{v,max}$** 

Rebar size	HDM 330, HDM 500	HDE 500	HIT-P8000D
	$l_{v,max}$ [mm]		
φ8	1000	1000	-
φ10		1000	-
φ12		1200	1200
φ13		1300	1300
φ14		1400	1400
φ16		1600	1600
φ18	700	1800	1800
φ20	600	2000	2000
φ22	500	1800	2200
φ24	300	1300	2400
φ25	300	1500	2500
φ26	300	1000	2600
φ28	300	1000	2800
φ30	-	1000	3000
φ32		700	3200
φ34		600	
φ36		600	
φ40		400	

**Drilling diameters**

Rebar size	Drilling			Diamond coring		
	Hammer drill (HD)	Hollow Drill Bit (HDB) <sup>b)</sup>	Compressed air drill (CA) <sup>c)</sup>	Dry (PCC) <sup>b)c)</sup>	Wet (DD) <sup>c)</sup>	With roughening tool (RT) <sup>b)</sup>
	d <sub>0</sub> [mm]					
φ8	12 (10 <sup>a)</sup> )	12	-	-	12 (10 <sup>a)</sup> )	-
φ10	14 (12 <sup>a)</sup> )	14 (12 <sup>a)</sup> )	-	-	14 (12 <sup>a)</sup> )	-
φ12	16 (14 <sup>a)</sup> )	16 (14 <sup>a)</sup> )	17	-	16 (14 <sup>a)</sup> )	-
φ12/ HZA(-R) M12	16	16	-	-	16	-
φ13	16	16	17	-	16	-
φ14	18	18	17	-	18	18
φ16	20	20	20	-	20	20
φ18	22	22	22	-	22	22
φ20	25	25	26	-	25	25
φ22	28	28	28	-	28	28
φ24	32 (30 <sup>a)</sup> )	32 (30 <sup>a)</sup> )	32	35	32	32
φ25	32 (30 <sup>a)</sup> )	32 (30 <sup>a)</sup> )	32	35	32	32
φ26	35	35	35	35	35	35
φ28	35	35	35	35	35	35
φ30	37	-	37	35	37	-
φ32	40	-	40	47	40	-
φ34 <sup>c)</sup>	45	-	42	47	45	-
φ36 <sup>c)</sup>	45	-	45	47	47	-
φ40 <sup>c)</sup>	55	-	57	52	52	-

a) Each of two given values can be used.

b) No cleaning required.

c) Only for EN 1992-1-1 design, not available for TR 069 design.

**Associated components for the use of Hilti Roughening tool TE-YRT**

Diamond coring		Roughening tool TE-YRT	Wear gauge RTG...
d <sub>0</sub> [mm]		d <sub>0</sub> [mm]	size
nominal	measured		
18	17,9 to 18,2	18	18
20	19,9 to 20,2	20	20
22	21,9 to 22,2	22	22
25	24,9 to 25,2	25	25
28	27,9 to 28,2	28	28
30	29,9 to 30,2	30	30
32	31,9 to 32,2	32	32
35	34,9 to 35,2	35	35

**Minimum roughening time t<sub>roughen</sub> (t<sub>roughen</sub> [sec] = h<sub>ef</sub> [mm] / 10)**

h <sub>ef</sub> [mm]	t <sub>roughen</sub> [sec]
0 to 100	10
101 to 200	20
201 to 300	30
301 to 400	40
401 to 500	50
501 to 600	60

## Setting instructions

**\*For detailed information on installation see instruction for use given with the package of the product.**

### Safety regulations.

Review the Material Safety Data Sheet (MSDS) before use for proper and safe handling! Wear well-fitting protective goggles and protective gloves when working with Hilti HIT-RE 500 V4.

### Drilling

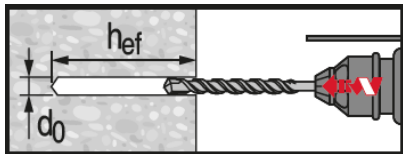

**Hammer drilled hole (HD)**

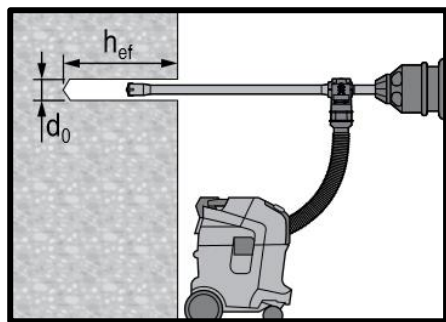

**Hammer drilled hole with Hollow Drilled Bit (HDB)**

No cleaning required.

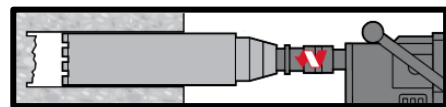

**Diamond Drilling (DD)**

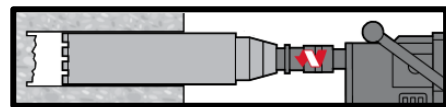

**Diamond Drilling + Roughening Tool (DD+RT)**

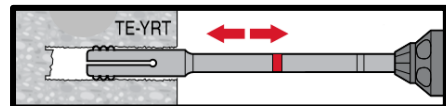

### Cleaning (Inadequate hole cleaning=poor load values.)

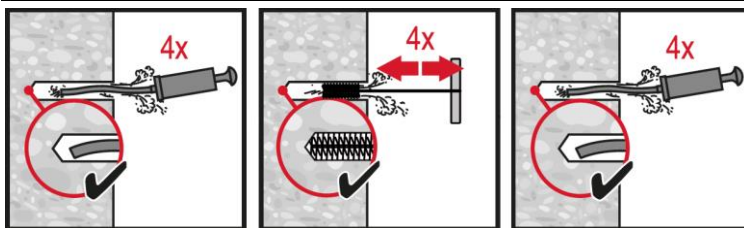

#### Hammer Drilling:

##### Manual cleaning (MC)

For drill diameters  $d_0 \leq 20$  mm and drill hole depth  $h_0 \leq 10 \cdot d$ .

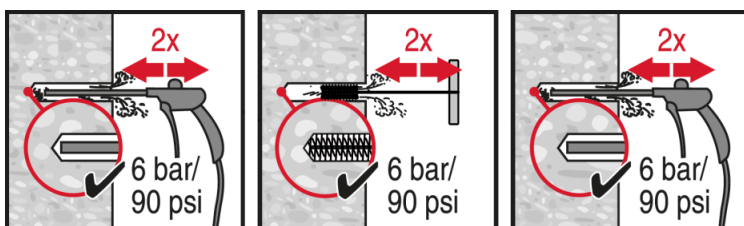

#### Hammer Drilling:

##### Compressed air cleaning (CAC)

For all drill hole diameters  $d_0$  and drill hole depths  $h_0 \leq 20 \cdot d$ .

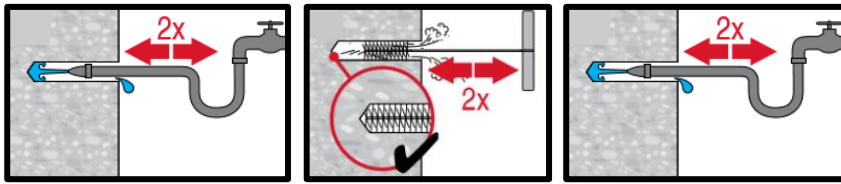

**Diamond cored holes:**

For all drill hole diameters  $d_0$  and drill hole depths  $h_0$ .

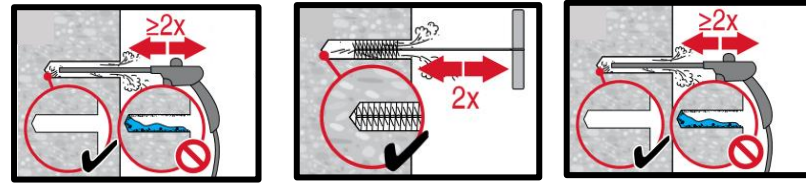

**Diamond cored holes with Hilti roughening tool:**

For all drill hole diameters  $d_0$  and drill hole depths  $h_0$ .

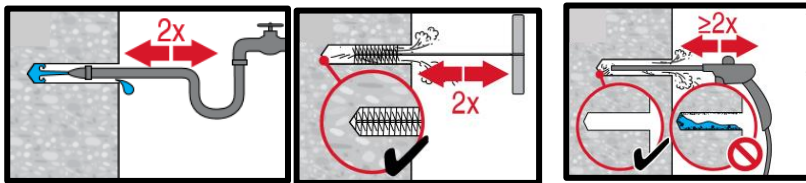

**Injection preparation**

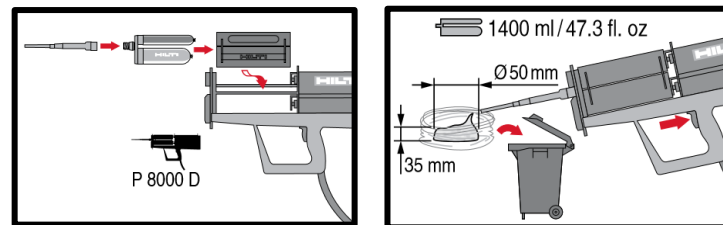

**Injection system preparation.**

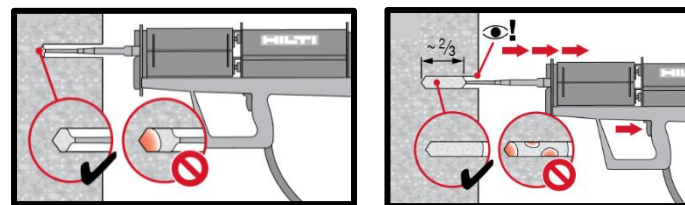

**Injection method for drill hole depth**  
 $h_{ef} \leq 250 \text{ mm}$ .

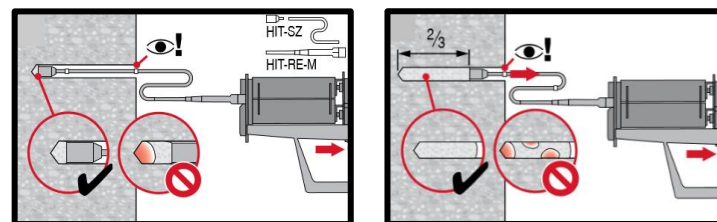

**Injection method for drill hole depth**  
 $h_{ef} > 250 \text{ mm}$ .

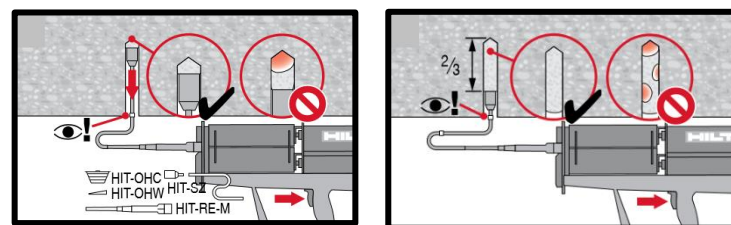

**Injection method for overhead application.**

**Setting the element**

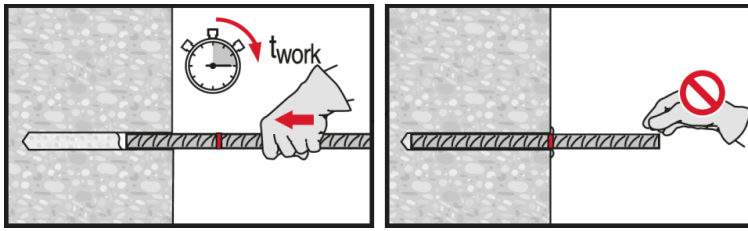

**Setting element**, observe working time " $t_{work}$ ".

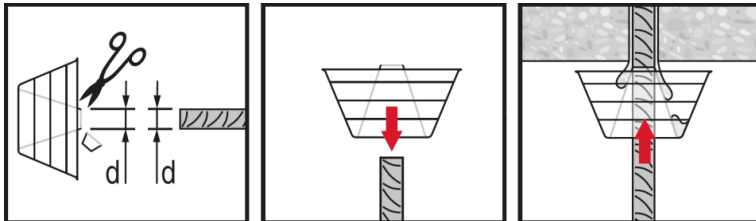

**Setting element** for overhead applications, observe working time " $t_{work}$ ".

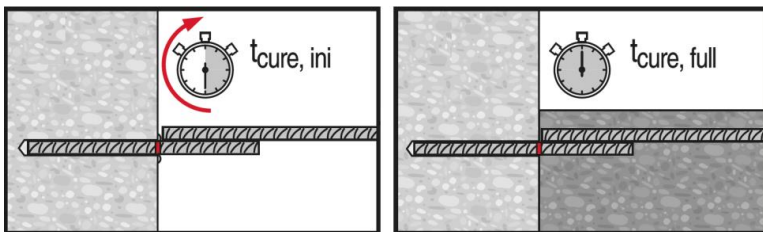
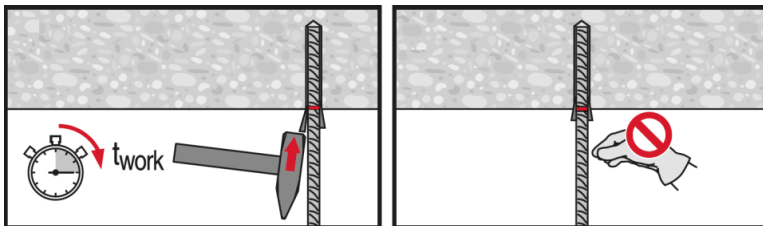

Apply full load only after curing time " $t_{cure}$ ".

## 2.1.4 HIT-RE 500 V3

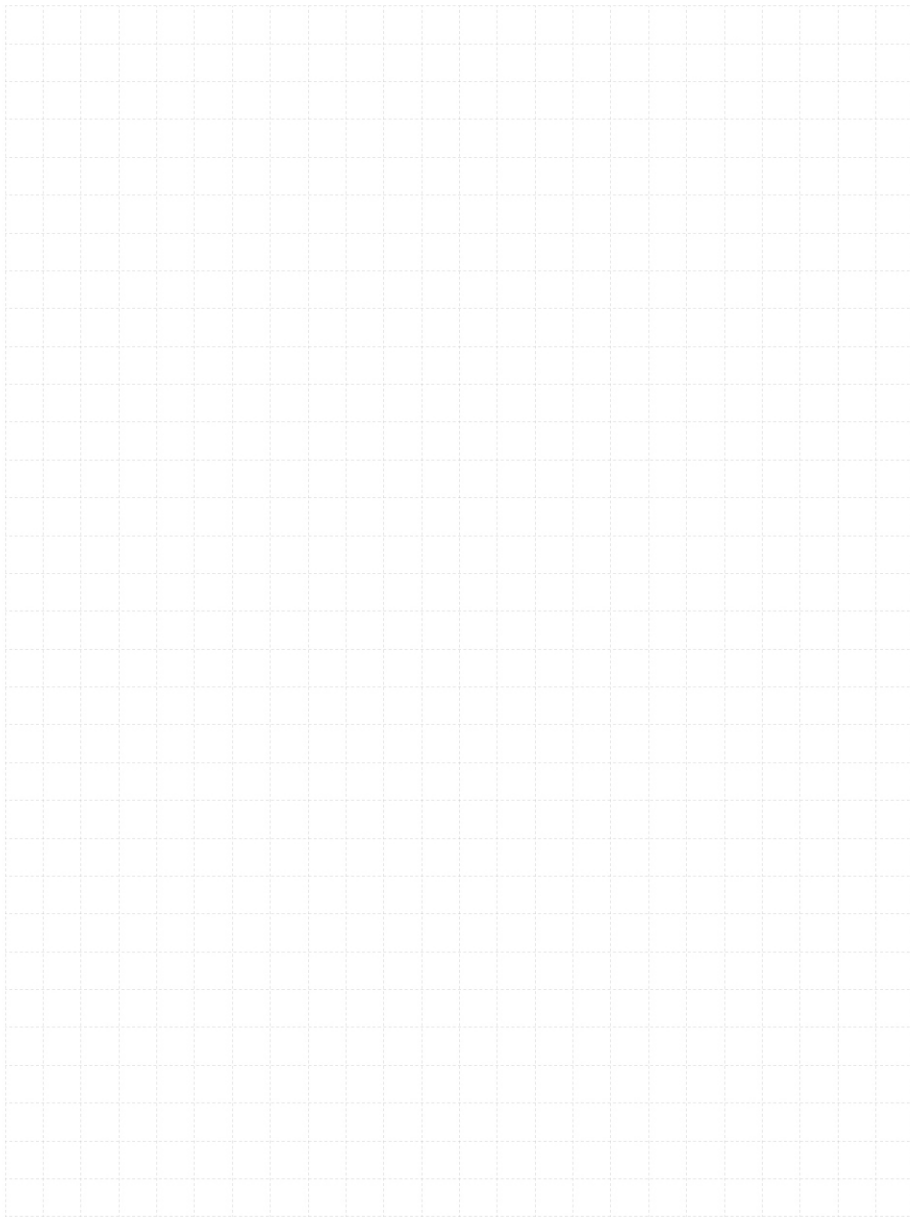



# HIT-RE 500 V3 injection mortar

## Anchor design (EN 1992-4) / Rods and Sleeves / Concrete

### Injection mortar system



Foil pack: HIT-RE 500 V3  
(available in 330, 500 and 1400 ml cartridges)



Anchor rod:  
HAS-U  
HAS-U HDG  
HAS-U A4  
HAS-U HCR  
AM 8.8 (HDG)  
(M8-M39)



Internally threaded sleeve:  
HIS-N  
HIS-RN  
(M8-M20)

### Benefits

- **SafeSet** technology: Simplified method of borehole preparation using either Hilti hollow drill bit for hammer drilling or Roughening tool for diamond cored applications
- Suitable for cracked/non-cracked concrete C 20/25 to C 50/60
- High loading capacity
- Suitable for dry and water saturated concrete
- Hilti Technical Data for under water application
- High corrosion resistance
- Long working time at elevated temperatures
- Cures down to -5°C
- Odourless epoxy

### Base material



Concrete (non-cracked)



Concrete (cracked)

### Installation conditions

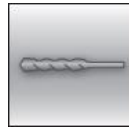

Hammer drilled holes



Diamond drilled holes

**SAFESET**

Hilti **SafeSet** technology

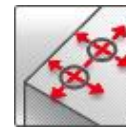

Small edge distance and spacing

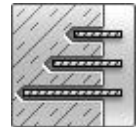

Variable embedment depth

### Load conditions

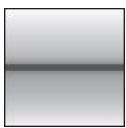

Static/  
quasi-static



Seismic,  
ETA-C1, C2



Fire  
resistance

### Other information



European  
Technical  
Assessment



CE conformity



PROFIS  
Engineering  
design  
Software

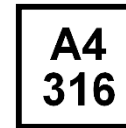

Corrosion  
resistance



High  
corrosion  
resistance <sup>a)</sup>

a) Applications only with HAS-U anchor rods

### Approvals / certificates

Description	Authority / Laboratory	No. / date of issue
European Technical Assessment <sup>a)</sup>	CSTB	ETA-16/0143 / 2019-05-14
Shockproof fastenings in civil defence installations	Federal Office for Civil Protection, Bern	BZS D 16-601/ 2016-08-31
Fire test report <sup>b)</sup>	MFPA Leipzig	GS 3.2/15-361-4 / 2016-08-04

a) All data given in this section according to ETA-16/0143, issue 2019-05-14.

b) Fire test report only available for HAS-U rods.



**Static and quasi-static resistance (for a single anchor)**
**All data in this section applies to:**

- Correct setting (See setting instruction)
- No edge distance and spacing influence
- Steel failure
- Base material thickness, as specified in the table
- Concrete C 20/25,  $f_{ck,cube} = 25 \text{ N/mm}^2$
- Temperature range I:  $-40 \text{ °C}$  to  $+40 \text{ °C}$   
(min. base material temperature  $-40 \text{ °C}$ , max. long/short term base material temperature:  $+24 \text{ °C}/40 \text{ °C}$ )
- Short term loading. For long term loading please apply  $\psi_{sus}$ .
  - Hammer drilled holes, hammer drilled holes with hollow drill bit and diamond cored holes with Hilti roughening tool:  $\psi_{sus} = 0.88$

**Embedment depth <sup>a)</sup> and base material thickness**

Anchor size	ETA-16/0143, issue 2019-05-14								Hilti technical data		
	M8	M10	M12	M16	M20	M24	M27	M30	M33	M36	M39
<b>HAS-U</b>											
Eff. anchorage depth [mm]	80	90	110	125	170	210	240	270	300	330	360
Base material thickness [mm]	110	120	140	161	214	266	300	340	374	410	444
<b>HIS-N</b>											
Eff. anchorage depth [mm]	90	110	125	170	205	-	-	-	-	-	-
Base material thickness [mm]	120	150	170	230	270	-	-	-	-	-	-

a) The allowed range of embedment depth is shown in the setting

**For hammer drilled holes, hollow drill bit<sup>1)</sup> and diamond cored with roughening tool<sup>2)</sup>:**
**Characteristic resistance**

Anchor size	ETA-16/0143, issue 2019-05-14								Hilti technical data			
	M8	M10	M12	M16	M20	M24	M27	M30	M33	M36	M39	
<b>Non-cracked concrete</b>												
Tension $N_{Rk}$ [kN]	HAS-U 5.8	18,0	29,0	42,0	76,9	122	168	205	244	286	330	376
	HAS-U 8.8, AM	29,0	46,0	63,5	76,9	122	168	205	244	286	330	376
	HAS-U A4	26,0	41,0	59,0	76,9	122	168	205	244	286	330	376
	HAS-U HCR	29,0	46,0	63,5	76,9	122	168	205	244	286	330	376
	HIS-N 8.8	25,0	46,0	67,0	121,9	116	-	-	-	-	-	-
Shear $V_{Rk}$ [kN]	HAS-U 5.8	9,0	15,0	21,0	39,0	61,0	88,0	115	140	174	204	244
	HAS-U 8.8, AM	15,0	23,0	34,0	63,0	98,0	141	184	224	278	327	390
	HAS-U A4	13,0	20,0	30,0	55,0	86,0	124	115	140	174	204	244
	HAS-U HCR	15,0	23,0	34,0	63,0	98,0	124	161	196	174	204	244
	HIS-N 8.8	13,0	23,0	34,0	63,0	58,0	-	-	-	-	-	-
<b>Cracked concrete</b>												
Tension $N_{Rk}$ [kN]	HAS-U 5.8	15,1	22,6	39,4	53,8	85,3	117	143	171	-	-	-
	HAS-U 8.8, AM	15,1	22,6	39,4	53,8	85,3	117	143	171	-	-	-
	HAS-U A4	15,1	22,6	39,4	53,8	85,3	117	143	171	-	-	-
	HAS-U HCR	15,1	22,6	39,4	53,8	85,3	117	143	171	-	-	-
	HIS-N 8.8	25,0	44,4	53,8	85,3	113	-	-	-	-	-	-
Shear $V_{Rk}$ [kN]	HAS-U 5.8	9,0	15,0	21,0	39,0	61,0	88,0	115	140	-	-	-
	HAS-U 8.8, AM	15,0	23,0	34,0	63,0	98,0	141	184	224	-	-	-
	HAS-U A4	13,0	20,0	30,0	55,0	86,0	124	115	140	-	-	-
	HAS-U HCR	15,0	23,0	34,0	63,0	98,0	124	161	196	-	-	-
	HIS-N 8.8	13,0	23,0	34,0	63,0	58,0	-	-	-	-	-	-

1) Hilti hollow drill bit available for element size M12-M30.

2) Roughening tools are available for element size M16-M30.

**Design resistance**

Anchor size		ETA-16/0143, issue 2019-05-14								Hilti tech. data		
		M8	M10	M12	M16	M20	M24	M27	M30	M33	M36	M39
<b>Non-cracked concrete</b>												
Tension $N_{Rd}$	HAS-U 5.8	12,0	19,3	28,0	45,8	72,7	99,8	122	146	142	164	187
	HAS-U 8.8, AM 8.8	19,3	28,0	37,8	45,8	72,7	99,8	122	146	142	164	187
	HAS-U A4 [kN]	13,9	21,9	31,6	45,8	72,7	99,8	80,4	98,3	121	143	171
	HAS-U HCR	19,3	28,0	37,8	45,8	72,7	99,8	122	146	142	164	187
	HIS-N 8.8	16,7	30,7	44,7	72,7	77,3	-	-	-	-	-	-
Shear $V_{Rd}$	HAS-U 5.8	7,2	12,0	16,8	31,2	48,8	70,4	92,0	112	139	163	195
	HAS-U 8.8, AM 8.8	12,0	18,4	27,2	50,4	78,4	113	147	179	222	262	312
	HAS-U A4 [kN]	8,3	12,8	19,2	35,3	55,1	79,5	48,3	58,8	73,1	85,7	103
	HAS-U HCR	12,0	18,4	27,2	50,4	78,4	70,9	92,0	112	87,0	102	122
	HIS-N 8.8	10,4	18,4	27,2	50,4	46,4	-	-	-	-	-	-
<b>Cracked concrete</b>												
Tension $N_{Rd}$	HAS-U 5.8	10,1	15,1	26,3	32,1	50,9	69,9	85,4	102	-	-	-
	HAS-U 8.8, AM 8.8	10,1	15,1	26,3	32,1	50,9	69,9	85,4	102	-	-	-
	HAS-U A4 [kN]	10,1	15,1	26,3	32,1	50,9	69,9	80,4	98,3	-	-	-
	HAS-U HCR	10,1	15,1	26,3	32,1	50,9	69,9	85,4	102	-	-	-
	HIS-N 8.8	16,7	26,5	32,1	50,9	67,4	-	-	-	-	-	-
Shear $V_{Rd}$	HAS-U 5.8	7,2	12,0	16,8	31,2	48,8	70,4	92,0	112	-	-	-
	HAS-U 8.8, AM 8.8	12,0	18,4	27,2	50,4	78,4	113	147	179	-	-	-
	HAS-U A4 [kN]	8,3	12,8	19,2	35,3	55,1	79,5	48,3	58,8	-	-	-
	HAS-U HCR	12,0	18,4	27,2	50,4	78,4	70,9	92,0	112	-	-	-
	HIS-N 8.8	10,4	18,4	27,2	50,4	46,4	-	-	-	-	-	-

1) Hilti hollow drill bit available for element size M12-M30.

2) Roughening tools are available for element size M16-M30.

**Recommended loads <sup>a)</sup>**

Anchor size		ETA-16/0143, issue 2019-05-14								Hilti technical data		
		M8	M10	M12	M16	M20	M24	M27	M30	M33	M36	M39
<b>Non-cracked concrete</b>												
Tension $N_{Rec}$	HAS-U 5.8	8,6	13,8	20,0	32,7	51,9	71,3	87,1	104	101	117	133
	HAS-U 8.8, AM	13,8	20,0	27,0	32,7	51,9	71,3	87,1	104	101	117	133
	HAS-U A4	9,9	15,7	22,5	32,7	51,9	71,3	57,4	70,2	86,7	102	122
	HAS-U HCR	13,8	20,0	27,0	32,7	51,9	71,3	87,1	104	101	117	133
	HIS-N 8.8	11,9	21,9	31,9	51,9	55,2	-	-	-	-	-	-
Shear $V_{Rec}$	HAS-U 5.8	5,1	8,6	12,0	22,3	34,9	50,3	65,7	80,0	99,4	117	139
	HAS-U 8.8, AM	8,6	13,1	19,4	36,0	56,0	80,6	105	128	159	187	223
	HAS-U A4	6,0	9,2	13,7	25,2	39,4	56,8	34,5	42,0	52,2	61,2	73,2
	HAS-U HCR	8,6	13,1	19,4	36,0	56,0	50,6	65,7	80,0	62,1	72,9	87,1
	HIS-N 8.8	7,4	13,1	19,4	36,0	33,1	-	-	-	-	-	-
<b>Cracked concrete</b>												
Tension $N_{Rec}$	HAS-U 5.8	7,2	10,8	18,8	22,9	36,3	49,9	61,0	72,7	-	-	-
	HAS-U 8.8, AM	7,2	10,8	18,8	22,9	36,3	49,9	61,0	72,7	-	-	-
	HAS-U A4	7,2	10,8	18,8	22,9	36,3	49,9	57,4	70,2	-	-	-
	HAS-U HCR	7,2	10,8	18,8	22,9	36,3	49,9	61,0	72,7	-	-	-
	HIS-N 8.8	11,9	18,9	22,9	36,3	48,1	-	-	-	-	-	-
Shear $V_{Rec}$	HAS-U 5.8	5,1	8,6	12,0	22,3	34,9	50,3	65,7	80,0	-	-	-
	HAS-U 8.8, AM	8,6	13,1	19,4	36,0	56,0	80,6	105	128	-	-	-
	HAS-U A4	6,0	9,2	13,7	25,2	39,4	56,8	34,5	42,0	-	-	-
	HAS-U HCR	8,6	13,1	19,4	36,0	56,0	50,6	65,7	80,0	-	-	-
	HIS-N 8.8	7,4	13,1	19,4	36,0	33,1	-	-	-	-	-	-

a) With overall partial safety factor for action  $\gamma=1,4$ . The partial safety factors for action depend on the type of loading and shall be taken from national regulations.

**For diamond drilling:**
**Characteristic resistance**

Anchor size		M8	M10	M12	M16	M20	M24	M27	M30
<b>Non-cracked concrete</b>									
Tension $N_{Rk}$	HAS-U 5.8	18,0	29,0	42,0	76,9	122	167	205	244
	HIS-N 8.8	25,0	46,0	67,0	122	116	-	-	-
Shear $V_{Rk}$	HAS-U 5.8	9,0	15,0	21,0	39,0	61,0	88,0	115	140
	HIS-N 8.8	13,0	23,0	34,0	63,0	58,0	-	-	-

**Design resistance**

Anchor size		M8	M10	M12	M16	M20	M24	M27	M30
<b>Non-cracked concrete</b>									
Tension $N_{Rd}$	HAS-U 5.8	12,0	19,3	28,0	32,7	51,9	71,3	87,1	104
	HIS-N 8.8	16,7	24,4	32,7	51,9	68,8	-	-	-
Shear $V_{Rd}$	HAS-U 5.8	7,2	12,0	16,8	31,2	48,8	70,4	92,0	112
	HIS-N 8.8	10,4	18,4	27,2	50,4	46,4	-	-	-

**Recommended loads <sup>b)</sup>**

Anchor size		M8	M10	M12	M16	M20	M24	M27	M30
<b>Non-cracked concrete</b>									
Tensile $N_{Rec}$	HAS-U 5.8	8,6	13,8	20,0	23,4	37,1	50,9	62,2	74,2
	HIS-N 8.8	11,9	17,5	23,4	37,1	49,1	-	-	-
Shear $V_{Rec}$	HAS-U 5.8	5,1	8,6	12,0	22,3	34,9	50,3	65,7	80,0
	HIS-N 8.8	7,4	13,1	19,4	36,0	33,1	-	-	-

a) With overall partial safety factor for action  $\gamma=1,4$ . The partial safety factors for action depend on the type of loading and shall be taken from national regulations.

**Seismic resistance**
**All data in this section applies to:**

- Correct setting (See setting instruction)
- No edge distance and spacing influence
- Steel failure
- Anchor HAS-U strength class 8.8, anchor AM 8.8
- Base material thickness, as specified in the table
- One typical embedment depth as specified in the table
- Concrete C 20/25,  $f_{ck,cube} = 25 \text{ N/mm}^2$
- Temperature range I  
(min. base material temperature  $-40^\circ\text{C}$ , max. long/short term base material temperature:  $+24^\circ\text{C}/40^\circ\text{C}$ )
- $\alpha_{gap}=1,0$  (using Hilti seismic filling set)

**Embedment depth and base material thickness for seismic C2 <sup>a)</sup> and C1**

Anchor size		M8	M10	M12	M16	M20	M24	M27	M30
<b>HAS-U</b>									
Eff. Anchorage depth	[mm]	80	90	110	125	170	210	240	270
Base material thickness	[mm]	110	120	140	161	214	266	300	340
<b>HIS-N</b>									
Eff. Anchorage depth	[mm]	90	110	125	170	205	-	-	-
Base material thickness	[mm]	120	146	169	226	269	-	-	-

a) C2 seismic approval only available for HAS-U rods.

**For hammer drilled holes, hollow drill bit and diamond cored with roughening tool:**
**Characteristic resistance in case of seismic performance category C2**

Anchor size		M8	M10	M12	M16	M20	M24	M27	M30
Tensile $N_{Rk}$	HAS-U 8.8, AM 8.8 [kN]	-	-	-	37,1	57,7	80,8	102	132
Shear $V_{Rk}$	HAS-U 8.8, AM 8.8 w/ filling set	-	-	-	46,0	77,0	103	-	-
	HAS-U 8.8, AM 8.8 w/o filling set	-	-	-	40,0	71,0	90,0	121	135

**Design resistance in case of seismic performance category C2**

Anchor size		M8	M10	M12	M16	M20	M24	M27	M30
Tensile $N_{Rd}$	HAS-U 8.8, AM 8.8 [kN]	-	-	-	24,7	38,5	53,8	67,9	88,2
Shear $V_{Rd}$	HAS-U 8.8, AM 8.8 w/ filling set	-	-	-	36,8	61,6	82,4	-	-
	HAS-U 8.8, AM 8.8 w/o filling set	-	-	-	32,0	56,8	72,0	96,8	108

**For hammer drilled holes and hammer drilled holes with Hilti hollow drill bit:**

**Characteristic resistance in case of seismic performance category C1**

Anchor size		M8	M10	M12	M16	M20	M24	M27	M30
Tensile $N_{Rk}$	HAS-U 8.8, AM 8.8	13,7	22,6	37,8	45,7	72,5	99,6	122	145
	HIS-N 8.8	25,0	37,8	45,7	72,5	96,1	-	-	-
Shear $V_{Rk}$	HAS-U 8.8, AM 8.8	15,0	23,0	34,0	63,0	98,0	141	184	224
	HIS-N 8.8	9,0	16,0	24,0	44,0	41,0	-	-	-

**Design resistance in case of seismic performance category C1**

Anchor size		M8	M10	M12	M16	M20	M24	M27	M30
Tensile $N_{Rd}$	HAS-U 8.8, AM 8.8	9,1	15,1	25,2	30,5	48,4	66,4	81,1	96,8
	HIS-N 8.8	16,7	25,2	30,5	48,4	64,0	-	-	-
Shear $V_{Rd}$	HAS-U 8.8, AM 8.8	12,0	18,4	27,2	50,4	78,4	113	147	179
	HIS-N 8.8	7,2	12,8	19,2	35,2	32,8	-	-	-

**Materials**
**Mechanical properties for HAS-U**

Anchor size		ETA-16/0143, issue 2019-05-14								Hilti Technical data		
		M8	M10	M12	M16	M20	M24	M27	M30	M33	M36	M39
Nominal tensile strength $f_{uk}$	HAS-U 5.8(F)	500	500	500	500	500	500	500	500	500	500	500
	HAS-U 8.8(F)	800	800	800	800	800	800	800	800	800	800	800
	AM 8.8(HDG)	800	800	800	800	800	800	800	800	800	800	800
	HAS-U A4	700	700	700	700	700	700	500	500	500	500	500
	HAS-U HCR	800	800	800	800	800	700	700	700	500	500	500
Yield strength $f_{yk}$	HAS-U 5.8(F)	400	400	400	400	400	400	400	400	400	400	400
	HAS-U 8.8(F)	640	640	640	640	640	640	640	640	640	640	640
	AM 8.8(HDG)	640	640	640	640	640	640	640	640	640	640	640
	HAS-U A4	450	450	450	450	450	450	210	210	210	210	210
	HAS-U HCR	640	640	640	640	640	400	400	400	250	250	250
Stressed cross-section $A_s$	HAS-U AM 8.8	36,6	58,0	84,3	157	245	353	459	561	694	817	976
Moment of resistance $W$	HAS-U AM 8.8	31,2	62,3	109	277	541	935	1387	1874	2579	3294	4301

**Mechanical properties for HIS-N**

Anchor size		ETA-16/0143, issue 2019-05-14				
		M8	M10	M12	M16	M20
Nominal tensile strength $f_{uk}$	HIS-N	490	490	460	460	460
	Screw 8.8	800	800	800	800	800
	HIS-RN	700	700	700	700	700
	Screw A4-70	700	700	700	700	700
Yield strength $f_{yk}$	HIS-N	410	410	375	375	375
	Screw 8.8	640	640	640	640	640
	HIS-RN	350	350	350	350	350
	Screw A4-70	450	450	450	450	450
Stressed cross-section $A_s$	HIS-(R)N	51,5	108	169	256	238
	Screw	36,6	58	84,3	157	245
Moment of resistance $W$	HIS-(R)N	145	430	840	1595	1543
	Screw	31,2	62,3	109	277	541

**Material quality for HAS-U**

Part	Material
<b>Zinc coated steel</b>	
Threaded rod, HAS-U 5.8 (HDG)	Strength class 5.8; Elongation at fracture A5 > 8% ductile Electroplated zinc coated $\geq 5\mu\text{m}$ ; (F) hot dip galvanized $\geq 45\mu\text{m}$
Threaded rod, HAS-U 8.8 (HDG)	Strength class 8.8; Elongation at fracture A5 > 12% ductile Electroplated zinc coated $\geq 5\mu\text{m}$ ; (F) hot dip galvanized $\geq 45\mu\text{m}$
Hilti Meter rod, AM 8.8 (HDG)	Strength class 8.8; Elongation at fracture A5 > 12% ductile Electroplated zinc coated $\geq 5\mu\text{m}$ (HDG) hot dip galvanized $\geq 45\mu\text{m}$
Washer	Electroplated zinc coated $\geq 5\mu\text{m}$ , hot dip galvanized $\geq 45\mu\text{m}$
Nut	Strength class of nut adapted to strength class of threaded rod. Electroplated zinc coated $\geq 5\mu\text{m}$ , hot dip galvanized $\geq 45\mu\text{m}$
<b>Stainless Steel</b>	
Threaded rod, HAS-U A4	Strength class 70 for $\leq M24$ and strength class 50 for $> M24$ ; Elongation at fracture A5 > 8% ductile Stainless steel 1.4401; 1.4404; 1.4578; 1.4571; 1.4439; 1.4362
Washer	Stainless steel 1.4401, 1.4404, 1.4578, 1.4571, 1.4439, 1.4362 EN 10088-1:2014
Nut	Stainless steel 1.4401, 1.4404, 1.4578, 1.4571, 1.4439, 1.4362 EN 10088-1:2014
<b>High corrosion resistant steel</b>	
Threaded rod, HAS-U HCR	Strength class 80 for $\leq M20$ and class 70 for $> M20$ , Elongation at fracture A5 > 8% ductile High corrosion resistance steel 1.4529; 1.4565;
Washer	High corrosion resistant steel 1.4529, 1.4565 EN 10088-1:2014
Nut	High corrosion resistant steel 1.4529, 1.4565 EN 10088-1:2014

**Material quality for HIS-N**

Part	Material	
HIS-N	Internal threaded sleeve	C-steel 1.0718; Steel galvanized $\geq 5\mu\text{m}$
	Screw 8.8	Strength class 8.8, A5 > 8 % Ductile; Steel galvanized $\geq 5\mu\text{m}$
HIS-RN	Internal threaded sleeve	Stainless steel 1.4401, 1.4571
	Screw 70	Strength class 70, A5 > 8 % Ductile Stainless steel 1.4401; 1.4404, 1.4578; 1.4571; 1.4439; 1.4362

**Setting information**
**Installation temperature**

-5°C to +40°C

**Service temperature range**

Hilti HIT-RE 500 V3 injection mortar may be applied in the temperature ranges given below. An elevated base material temperature may lead to a reduction of the design bond resistance.

Temperature range	Base material temperature	Max. long term base material temperature	Max. short term base material temperature
Temperature range I	-40 °C to +40 °C	+24 °C	+40 °C
Temperature range II	-40 °C to +70 °C	+43 °C	+70 °C

### Max short term base material temperature

Short-term elevated base material temperatures are those that occur over brief intervals, e.g. as a result of diurnal cycling.

### Max long term base material temperature

Long-term elevated base material temperatures are roughly constant over significant periods of time.

### Working time and curing time

Temperature of the base material T	Working time $t_{work}$	Minimum curing time $t_{cure}^{1)}$
-5 °C to -1 °C	2 h	168 h
0 °C to 4 °C	2 h	48 h
5 °C to 9 °C	2 h	24 h
10 °C to 14 °C	1,5 h	16 h
15 °C to 19 °C	1 h	12 h
20 °C to 24 °C	30 min	7 h
25 °C to 29 °C	20 min	6 h
30 °C to 34 °C	15 min	5 h
35 °C to 39 °C	12 min	4,5 h
40 °C	10 min	4 h

1) The curing time data are valid for dry base material only. In wet base material, the curing times must be doubled.

### Setting details for HAS-U

Anchor size	ETA-16/0143, issue 2019-05-14								Hilti Technical data			
	M8	M10	M12	M16	M20	M24	M27	M30	M33	M36	M39	
Nominal diameter of drill bit $d_0$ [mm]	10	12	14	18	22	28	30	35	37	40	42	
Effective anchorage and drill hole depth range <sup>a)</sup>	$h_{ef,min}$ [mm]	60	60	70	80	90	96	108	120	132	144	156
	$h_{ef,max}$ [mm]	160	200	240	320	400	480	540	600	660	720	780
Minimum base material thickness $h_{min}$ [mm]	$h_{ef} + 30 \text{ mm}$ $\geq 100 \text{ mm}$			$h_{ef} + 2 d_0$								
Max. torque moment $T_{max}$ [Nm]	10	20	40	80	150	200	270	300	330	360	390	
Minimum spacing $s_{min}$ [mm]	40	50	60	75	90	115	120	140	165	180	195	
Min. edge distance $c_{min}$ [mm]	40	45	45	50	55	60	75	80	165	180	195	
Critical spacing for splitting failure $s_{cr,sp}$ [mm]	$2 C_{cr,sp}$											
Critical edge distance for splitting failure <sup>b)</sup> $c_{cr,sp}$ [mm]	$1,0 \cdot h_{ef}$ for $h / h_{ef} \geq 2,0$											
	$4,6 h_{ef} - 1,8 h$ for $2,0 > h / h_{ef} > 1,3$											
	$2,26 h_{ef}$ for $h / h_{ef} \leq 1,3$											
Critical spacing for concrete cone failure $s_{cr,N}$ [mm]	$2 C_{cr,N}$											
Critical edge distance for concrete cone failure <sup>c)</sup> $c_{cr,N}$ [mm]	$1,5 h_{ef}$											

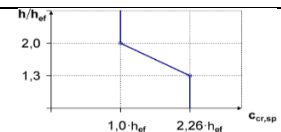

### HAS-U-...

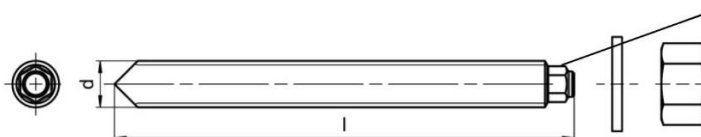

#### Marking:

Steel grade number and length identification letter: e.g. 8 L

**Setting details for HIS-N**

Anchor size		M8	M10	M12	M16	M20
Nominal diameter of drill	$d_0$ [mm]	14	18	22	28	32
Diameter of element	$d$ [mm]	12,5	16,5	20,5	25,4	27,6
Effective anchorage and drill hole depth	$h_{ef}$ [mm]	90	110	125	170	205
Minimum base material thickness	$h_{min}$ [mm]	120	150	170	230	270
Diameter of clearance hole in the fixture	$d_f$ [mm]	9	12	14	18	22
Thread engagement length; min - max	$h_s$ [mm]	8-20	10-25	12-30	16-40	20-50
Minimum spacing	$s_{min}$ [mm]	60	70	90	115	130
Minimum edge distance	$c_{min}$ [mm]	40	45	55	65	90
Critical spacing for splitting failure	$s_{cr,sp}$ [mm]	$2 C_{cr,sp}$				
Critical edge distance for splitting failure <sup>b)</sup>	$C_{cr,sp}$ [mm]	$1,0 \cdot h_{ef}$ for $h / h_{ef} \geq 2,0$				
		$4,6 h_{ef} - 1,8 h$ for $2,0 > h / h_{ef} > 1,3$				
		$2,26 h_{ef}$ for $h / h_{ef} \leq 1,3$				
Critical spacing for concrete cone failure	$s_{cr,N}$ [mm]	$2 C_{cr,N}$				
Critical edge distance for concrete cone failure <sup>c)</sup>	$C_{cr,N}$ [mm]	$1,5 h_{ef}$				
Max. torque moment <sup>a)</sup>	$T_{max}$ [Nm]	10	20	40	80	150

For spacing (edge distance) smaller than critical spacing (critical edge distance) the design loads have to be reduced.

a)  $h_{ef,min} \leq h_{ef} \leq h_{ef,max}$  ( $h_{ef}$ : embedment depth)

b)  $h$ : base material thickness ( $h \geq h_{min}$ )

c) The critical edge distance for concrete cone failure depends on the embedment depth  $h_{ef}$  and the design bond resistance. The simplified formula given in this table is on the save side.

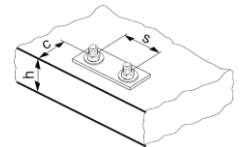
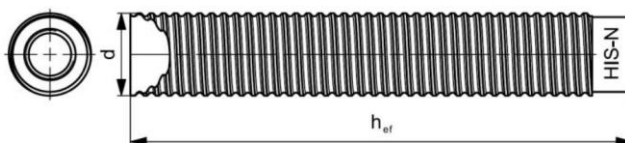
**Internally threaded sleeve HIS-(R)N...**

**Marking:**

Identifying mark - HILTI and embossing "HIS-N" (for zinc coated steel)  
embossing "HIS-RN" (for stainless steel)

**Installation equipment**

Anchor size		M8	M10	M12	M16	M20	M24	M27	M30	M36	M39	
Rotary hammer	HAS-U	TE 2 – TE 16				TE 40 – TE 80				Not available from Hilti		
	HIS-N	TE 2 – TE 16	TE 40 – TE 80			-						
Other tools	compressed air gun, set of cleaning brushes, dispenser											
	roughening tools TE-YRT										-	
Additional Hilti recommended tools		DD EC-1, DD 100 ... DD 160 <sup>a)</sup>									-	

a) For anchors in diamond drilled holes load values for combined pull-out and concrete cone resistance have to be reduced



**Minimum roughening time  $t_{\text{roughen}}$  ( $t_{\text{roughen}} [\text{sec}] = h_{\text{ef}} [\text{mm}] / 10$ )**

$h_{\text{ef}} [\text{mm}]$	$t_{\text{roughen}} [\text{sec}]$
0 to 100	10
101 to 200	20
201 to 300	30
301 to 400	40
401 to 500	50
501 to 600	60

**Parameters of cleaning and setting tools**

HAS-U	HIS-N	Drill bit diameters $d_0$ [mm]				Installation	
		Hammer drill (HD)	Hollow Drill Bit (HDB)	Diamond coring		Brush HIT-RB	Piston plug HIT-SZ
				Diamond coring (DD)	With roughening tool (RT)		
<b>M8</b>	-	10	-	10	-	10	-
<b>M10</b>	-	12	-	12	-	12	12
<b>M12</b>	<b>M8</b>	14	14	14	-	14	14
<b>M16</b>	<b>M10</b>	18	18	18	18	18	18
<b>M20</b>	<b>M12</b>	22	22	22	22	22	22
<b>M24</b>	<b>M16</b>	28	28	28	28	28	28
<b>M27</b>	-	30	-	30	30	30	30
-	<b>M20</b>	32	32	32	32	32	32
<b>M30</b>	-	35	35	35	35	35	35
<b>M33</b>	-	37	-	-	-	37	37
<b>M36</b>	-	40	-	-	-	40	40
<b>M39</b>	-	42	-	-	-	42	42

**Associated components for the use of Hilti Roughening tool TE-YRT**

Diamond coring		Roughening tool TE-YRT	Wear gauge RTG...
$d_0$ [mm]		$d_0$ [mm]	size
Nominal	measured		
18	17,9 to 18,2	18	18
20	19,9 to 20,2	20	20
22	21,9 to 22,2	22	22
25	24,9 to 25,2	25	25
28	27,9 to 28,2	28	28
30	29,9 to 30,2	30	30
32	31,9 to 32,2	32	32
35	34,9 to 35,2	35	35

## Setting instructions

\*For detailed information on installation see instruction for use given with the package of the product.



### Safety regulations.

Review the Material Safety Data Sheet (MSDS) before use for proper and safe handling! Wear well-fitting protective goggles and protective gloves when working with Hilti HIT-RE 500 V3.

## Drilling

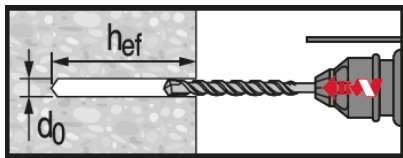

### Hammer drilled hole

For dry and wet concrete and installation in flooded holes (no sea water).

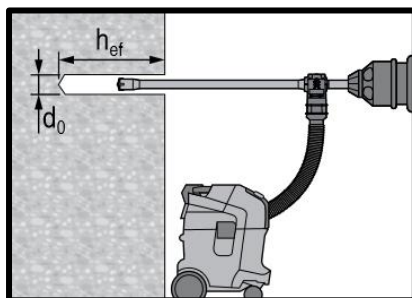

### Hammer drilled hole with Hollow Drilled Bit (HDB)

No cleaning required.  
For dry and wet concrete, only.

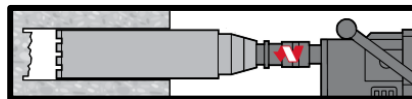

### Diamond Coring

For dry and wet concrete, only.

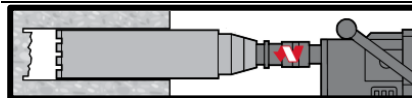

### Diamond Coring + Roughening Tool

For dry and wet concrete only.  
Before roughening, the borehole needs to be dry.

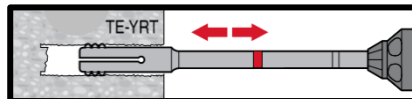

## Cleaning ( Inadequate hole cleaning=poor load values.)

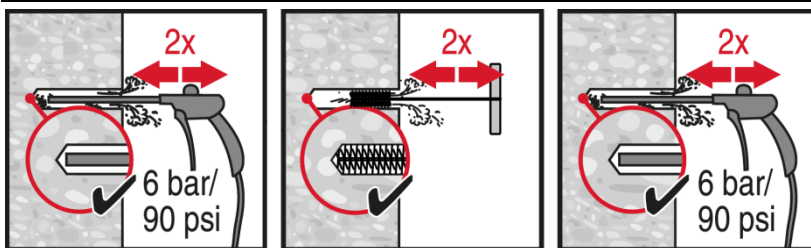

### Hammer Drilling:

#### Compressed air cleaning (CAC)

For all drill hole diameters  $d_0$  and all drill hole depths  $h_0$ .

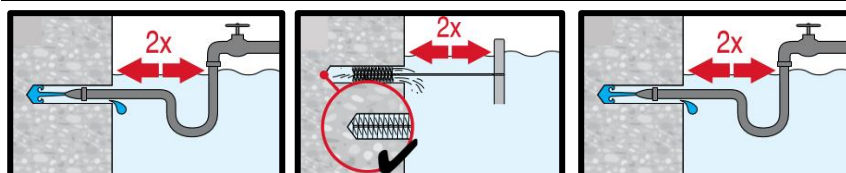

### Hammer drilling:

#### Cleaning for under water:

For all bore hole diameters  $d_0$  and all bore hole depth  $h_0$ .

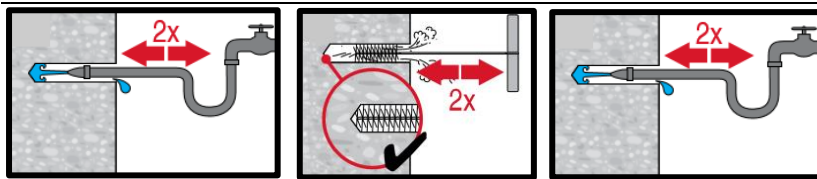

**Hammer drilled flooded holes and diamond cored holes:**

**Compressed air cleaning (CAC)** for all drill hole diameters  $d_0$  and drill hole depths  $h_0$ .

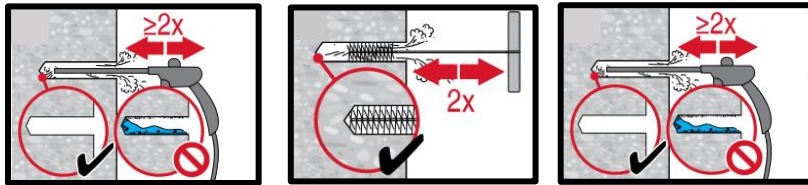

**Diamond cored holes with Hilti roughening tool:**

**Compressed air cleaning (CAC)** for all drill hole diameters  $d_0$  and drill hole depths  $h_0$ .

**Injection preparation**

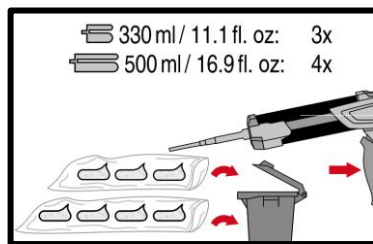
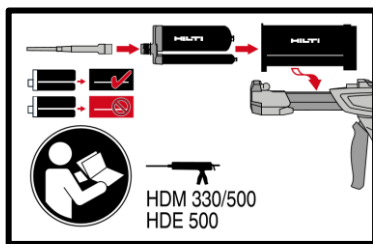

**Injection system preparation.**

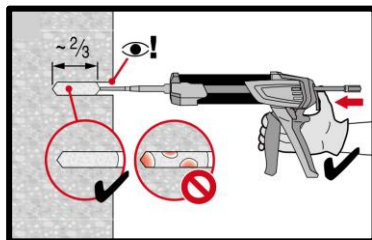
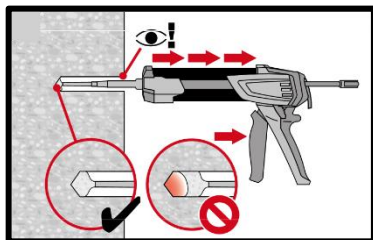

**Injection method for drill hole depth**  
 $h_{ef} \leq 250$  mm.

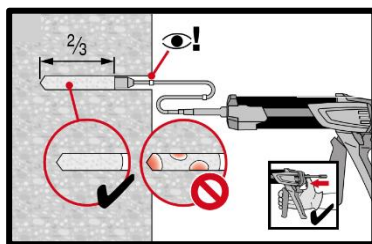
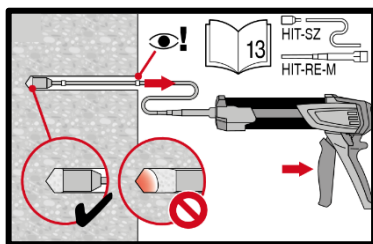

**Injection method for drill hole depth**  
 $h_{ef} > 250$  mm.

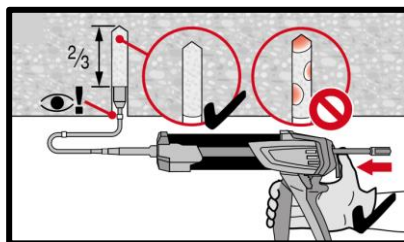
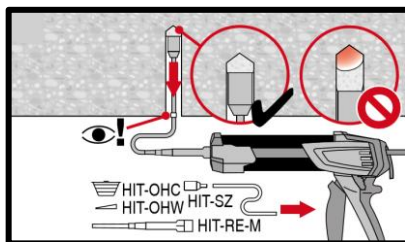

**Injection method for overhead application.**

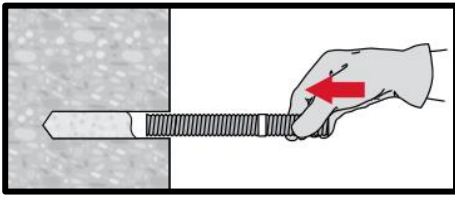
**Setting the element**

**Setting element**, observe working time " $t_{work}$ ",

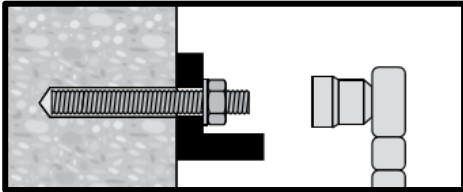

**Loading the anchor** after required curing time  $t_{cure}$  the anchor can be loaded. The applied installation torque shall not exceed  $T_{max}$ .

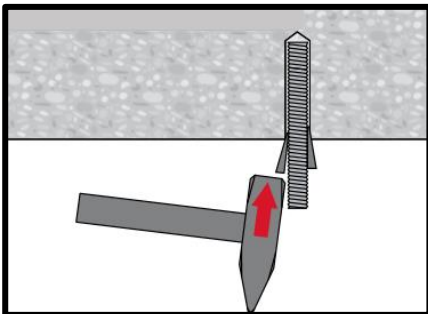

**Setting element** for overhead applications, observe working time " $t_{work}$ "

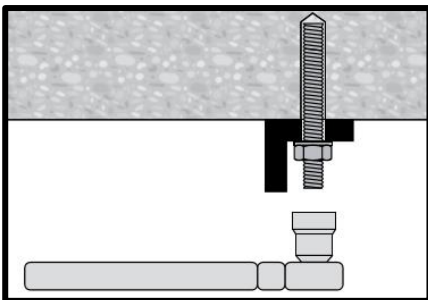

**Loading the anchor** after required curing time  $t_{cure}$  the anchor can be loaded. The applied installation torque shall not exceed  $T_{max}$ .

# HIT-RE 500 V3 injection mortar

Anchor design (EN 1992-4) / Rebar elements / Concrete

## Injection mortar system



Hilti  
HIT-RE 500 V3  
500 ml foil pack  
(also available as  
330 ml and 1400  
ml foil pack)



Rebar B500 B  
( $\phi 8$  -  $\phi 40$ )

## Benefits

- **SafeSet** technology: Simplified method of borehole preparation using either Hilti hollow drill bit for hammer drilling or Roughening tool for diamond cored applications
- Suitable for non-cracked and cracked concrete C 20/25 to C 50/60
- ETA approval for seismic performance category C1
- Hilti Technical Data for seismic performance category C2
- High loading capacity
- Suitable for dry and water saturated concrete
- Hilti Technical Data for under water application
- Fastest curing epoxy mortar to speed up construction process
- Long working time to allow installation of big diameters and/or deep embedment depths even at higher temperature
- Cures down to -5°C

## Base material



Concrete  
(non-  
cracked)



Concrete  
(cracked)



Dry concrete



Wet  
concrete

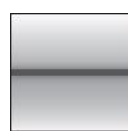

Static/  
quasi-static



Seismic,  
ETA-C1  
Hilti Technical Data-C2

## Installation conditions

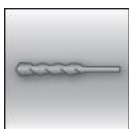

Hammer  
drilling



Diamond  
coring

**SAFE-SET**

Hilti **SafeSet**  
technology

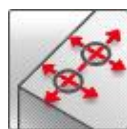

Small edge  
distance and  
spacing



European  
Technical  
Assessment



CE  
conformity



PROFIS  
Engineering  
design  
Software

## Load conditions

## Other informations

## Approvals / certificates

Description	Authority / Laboratory	No. / date of issue
European technical assessment <sup>a)</sup>	CSTB, Marne la Vallée	ETA-16/0143 / 2019-05-14

a) All data given in this section according to ETA-16/0143 issue 2019-05-14.

## Static and quasi-static loading (for a single anchor)

### All data in this section applies to

- Design according to TR029
- Correct setting (See setting instruction)
- No edge distance and spacing influence
- Steel failure
- Base material thickness, as specified in the table
- One typical embedment depth, as specified in the table
- Rebar B500B
- Concrete C 20/25,  $f_{ck,cube} = 25 \text{ N/mm}^2$
- Temperate range I (min. base material temp.  $-40^\circ\text{C}$ , max. long term/short term base material temp.:  $+24^\circ\text{C}/40^\circ\text{C}$ )
- Short term loading. For long term loading please apply  $\psi_{sus}$ .
  - Hammer drilled holes, hammer drilled holes with hollow drill bit and diamond cored holes with Hilti roughening tool:  $\psi_{sus} = 0.88$

### Embedment depth and base material thickness for static and quasi-static loading data

Anchor- size	ETA-16/0143, issue 2019-05-14										Hilti technical data	
	$\phi 8$	$\phi 10$	$\phi 12$	$\phi 14$	$\phi 16$	$\phi 20$	$\phi 25$	$\phi 28$	$\phi 30$	$\phi 32$	$\phi 36$	$\phi 40$
Typ. embedment depth [mm]	80	90	110	125	125	170	210	270	270	300	330	360
Base material thickness [mm]	110	120	142	161	165	220	274	340	344	380	420	470

### For hammer drilled holes, hollow drill bit<sup>1)</sup> and diamond cored with roughening tool<sup>2)</sup>:

- 1) Hilti hollow drill bit available for element size  $\phi 10$ - $\phi 28$ .
- 2) Roughening tools are available for element size  $\phi 14$ - $\phi 28$ .

### Characteristic resistance

Anchor- size	ETA-16/0143, issue 2019-05-14										Hilti technical data			
	$\phi 8$	$\phi 10$	$\phi 12$	$\phi 14$	$\phi 16$	$\phi 20$	$\phi 25$	$\phi 28$	$\phi 30$	$\phi 32$	$\phi 36$	$\phi 40$		
<b>Non-cracked concrete</b>														
Tensile $N_{Rk}$	B500B	[kN]	20,1	42,4	62,0	76,9	76,9	122	167	244	244	286	330	376
Shear $V_{Rk}$	B500B		14,0	22,0	31,0	42,0	55,0	86,0	135	169	194	221	280	346
<b>Cracked concrete</b>														
Tensile $N_{Rk}$	B500B	[kN]	-	24,0	39,4	52,2	53,8	85,3	117	171	171	200	-	-
Shear $V_{Rk}$	B500B		-	22,0	31,0	42,0	55,0	86,0	135	169	194	221	-	-

- 1) Hilti hollow drill bit available for element size  $\phi 10$ - $\phi 28$ .
- 2) Roughening tools are available for element size  $\phi 14$ - $\phi 28$ .

### Design resistance

Anchor- size	ETA-16/0143, issue 2019-05-14										Hilti technical data			
	$\phi 8$	$\phi 10$	$\phi 12$	$\phi 14$	$\phi 16$	$\phi 20$	$\phi 25$	$\phi 28$	$\phi 30$	$\phi 32$	$\phi 36$	$\phi 40$		
<b>Non-cracked concrete</b>														
Tensile $N_{Rd}$	B500B	[kN]	13,4	28,0	37,8	45,8	45,8	72,7	99,8	146	146	170	164	187
Shear $V_{Rd}$	B500B		9,3	14,7	20,7	28,0	36,7	57,3	90,0	113	129	147	187	231
<b>Cracked concrete</b>														
Tensile $N_{Rd}$	B500B	[kN]	-	16,0	26,3	32,1	32,1	50,9	69,9	102	102	119	-	-
Shear $V_{Rd}$	B500B		-	14,7	20,7	28,0	36,7	57,3	90,0	113	129	147	-	-

- 1) Hilti hollow drill bit available for element size  $\phi 10$ - $\phi 28$ .
- 2) Roughening tools are available for element size  $\phi 14$ - $\phi 28$ .

**Recommended loads<sup>3)</sup>**

Anchor- size		ETA-16/0143, issue 2019-05-14										Hilti technical data		
		φ8	φ10	φ12	φ14	φ16	φ20	φ25	φ28	φ30	φ32	φ36	φ40	
<b>Non-cracked concrete</b>														
Tensile N <sub>Rec</sub>	B500B	[kN]	9,6	20,0	27,0	32,7	32,7	51,9	71,3	104	104	122	117	133
Shear V <sub>Rec</sub>	B500B		6,7	10,5	14,8	20,0	26,2	41,0	64,3	80,5	92,4	105	133	165
<b>Cracked concrete</b>														
Tensile N <sub>Rec</sub>	B500B	[kN]	-	11,4	18,8	22,9	22,9	36,3	49,9	72,7	72,7	85,2	-	-
Shear V <sub>Rec</sub>	B500B		-	10,5	14,8	20,0	26,2	41,0	64,3	80,5	92,4	105	-	-

1) Hilti hollow drill bit available for element size φ10-φ28.

2) Roughening tools are available for element size φ14-φ28.

3) With overall partial safety factor for action  $\gamma=1,4$ . The partial safety factors for action depend on the type of loading and shall be taken from national regulations.

**For diamond cored holes:**
**Characteristic resistance**

Anchor- size		ETA-16/0143, issue 2019-05-14										
		φ8	φ10	φ12	φ14	φ16	φ20	φ25	φ28	φ30	φ32	
Tensile N <sub>Rk</sub>	B500B	[kN]	18,1	25,4	37,3	49,5	56,5	96,1	148	226	242	286
Shear V <sub>Rk</sub>	B500B		14,0	22,0	31,0	42,0	55,0	86,0	135	169	194	221

**Design resistance**

Anchor- size		ETA-16/0143, issue 2019-05-14										
		φ8	φ10	φ12	φ14	φ16	φ20	φ25	φ28	φ30	φ32	
Tensile N <sub>Rd</sub>	B500B	[kN]	10,1	14,1	20,7	27,5	26,9	45,8	70,7	104	104	122
Shear V <sub>Rd</sub>	B500B		9,3	14,7	20,7	28,0	36,7	57,3	90,0	113	129	147

**Recommended loads<sup>a)</sup>**

Anchor- size		ETA-16/0143, issue 2019-05-14										
		φ8	φ10	φ12	φ14	φ16	φ20	φ25	φ28	φ30	φ32	
Tensile N <sub>Rec</sub>	B500B	[kN]	7,2	10,1	14,8	19,6	19,2	32,7	50,5	74,2	74,2	86,9
Shear V <sub>Rec</sub>	B500B		6,7	10,5	14,8	20,0	26,2	41,0	64,3	80,5	92,4	105

a) With overall partial safety factor for action  $\gamma=1,4$ . The partial safety factors for action depend on the type of loading and shall be taken from national regulations.



## Seismic loading (for a single anchor)

### All data in this section applies to:

- Design according to TR 045
- Correct setting (See setting)
- No edge distance and spacing influence
- Steel failure
- Minimum base material thickness
- Concrete C 20/25,  $f_{ck,cube} = 25 \text{ N/mm}^2$
- Rebar B450C
- Temperature range I  
(min. base material temperature  $-40^\circ\text{C}$ , max. long term/short term base material temperature:  $+24^\circ\text{C}/40^\circ\text{C}$ )
- Installation temperature range  $-5^\circ\text{C}$  to  $+40^\circ\text{C}$
- $\alpha_{gap} = 1,0$

### For hammer drilled holes, hollow drill bit<sup>2)</sup> and diamond cored with roughening tool<sup>3)</sup>:

#### Embedment depth and base material thickness in case of seismic performance category C1

Anchor- size	$\phi 8$	$\phi 10$	$\phi 12$	$\phi 14$	$\phi 16$	$\phi 20$	$\phi 25$	$\phi 28$	$\phi 30$	$\phi 32$	$\phi 36$	$\phi 40$
Typical embedment depth [mm]	-	90	110	125	125	170	210	270	270	300	-	-
Base material thickness [mm]	-	120	142	161	165	220	274	340	344	380	-	-

#### Characteristic resistance in case of seismic performance category C1

Anchor- size	$\phi 8$	$\phi 10$	$\phi 12$	$\phi 14$	$\phi 16$	$\phi 20$	$\phi 25$	$\phi 28$	$\phi 30$	$\phi 32$	$\phi 36$	$\phi 40$
Tensile $N_{Rk, seis}$ B500B [kN]	-	23,2	36,1	45,7	45,7	72,5	99,6	145	145	170	-	-
Shear $V_{Rk, seis}$ B500B [kN]	-	15,0	22,0	29,0	39,0	60,0	95,0	118	136	155	-	-

- 1) Hilti hollow drill bit available for element size  $\phi 10$ - $\phi 28$ .
- 2) Roughening tools are available for element size  $\phi 14$ - $\phi 28$ .

#### Design resistance in case of seismic performance category C1

Anchor- size	$\phi 8$	$\phi 10$	$\phi 12$	$\phi 14$	$\phi 16$	$\phi 20$	$\phi 25$	$\phi 28$	$\phi 30$	$\phi 32$	$\phi 36$	$\phi 40$
Tensile $N_{Rd, seis}$ B500B [kN]	-	15,5	24,1	30,5	30,5	48,4	66,4	96,8	96,8	113	-	-
Shear $V_{Rd, seis}$ B500B [kN]	-	10,0	14,7	19,3	26,0	40,0	63,3	78,7	90,7	103	-	-

- 1) Hilti hollow drill bit available for element size  $\phi 10$ - $\phi 28$ .
- 2) Roughening tools are available for element size  $\phi 14$ - $\phi 28$ .

## Materials

### Mechanical properties

Anchor size		$\phi 8$	$\phi 10$	$\phi 12$	$\phi 14$	$\phi 16$	$\phi 20$	$\phi 25$	$\phi 28$	$\phi 30$	$\phi 32$	$\phi 36$	$\phi 40$
Nominal tensile strength $f_{uk}$	B500B [N/mm <sup>2</sup> ]	550	550	550	550	550	550	550	550	550	550	550	550
	B450C [N/mm <sup>2</sup> ]	-	-	-	-	518	518	518	-	-	-	-	-
Yield strength $f_{yk}$	B500B [N/mm <sup>2</sup> ]	500	500	500	500	500	500	500	500	500	500	500	500
	B450C [N/mm <sup>2</sup> ]	-	-	-	-	450	450	450	-	-	-	-	-
Stressed cross-section $A_s$	B500B [mm <sup>2</sup> ]	50,3	78,5	113	154	201	314	491	616	707	804	1018	1257
	B450C [mm <sup>2</sup> ]	-	-	-	-	201	314	491	-	-	-	-	-
Moment of resistance W	B500B [mm <sup>3</sup> ]	50,3	98,2	170	269	402	785	1534	2155	2650	3217	4580	6283
	B450C [mm <sup>3</sup> ]	-	-	-	-	402	785	1534	-	-	-	-	-

### Material quality

Part	Material
Rebar EN 1992-1-1:2004 and AC:2010	Bars and de-coiled rods class B or C with $f_{yk}$ and k according to NDP or NCL of EN 1992-1-1/ NA:2013 $f_{uk} = f_{tk} = k \cdot f_{yk}$



## Setting information

### Installation temperature range:

-5°C to +40°C

### Service temperature range

Hilti HIT-RE 500 V3 injection mortar may be applied in the temperature ranges given below. An elevated base material temperature may lead to a reduction of the design bond resistance.

Temperature range	Base material temperature	Max. long term base material temperature	Max. short term base material temperature
Temperature range I	-40 °C to + 40 °C	+ 24 °C	+ 40 °C
Temperature range II	-40 °C to + 70 °C	+ 43 °C	+ 70 °C

### Max. short term base material temperature

Short term elevated base material temperatures are those that occur over brief intervals, e.g. as a result of diurnal cycling.

### Max. long term base material temperature

Long term elevated base material temperatures are roughly constant over significant periods of time.

### Working time and curing time

Temperature of the base material	Max. working time in which rebar can be inserted and adjusted $t_{gel}$	Min. curing time before rebar can be fully loaded $t_{cure}^{1)}$
$-5\text{ °C} \leq T_{BM} < -1\text{ °C}$	2 h	168 h
$0\text{ °C} \leq T_{BM} < 4\text{ °C}$	2 h	48 h
$5\text{ °C} \leq T_{BM} < 9\text{ °C}$	2 h	24 h
$10\text{ °C} \leq T_{BM} < 14\text{ °C}$	1,5 h	16 h
$15\text{ °C} \leq T_{BM} < 19\text{ °C}$	1 h	12 h
$20\text{ °C} \leq T_{BM} < 24\text{ °C}$	30 min	7 h
$25\text{ °C} \leq T_{BM} < 29\text{ °C}$	20 min	6 h
$30\text{ °C} \leq T_{BM} < 34\text{ °C}$	15 min	5 h
$35\text{ °C} \leq T_{BM} < 39\text{ °C}$	12 min	4,5 h
$T_{BM} = 40\text{ °C}$	10 min	4 h

1) The curing time data are valid for dry base material only. In wet base material the curing times must be doubled.

### Installation equipment

Rebar – size	φ8	φ10	φ12	φ14	φ16	φ20	φ25	φ28	φ30	φ32	φ36	φ40
Rotary hammer	TE 2 (-A) – TE 40(-A)						TE40 – TE80					
Diamond coring tools	DD EC-1, DD 100 ... DD 160 <sup>a)</sup>											
Other tools	Compressed air gun, brush, hollow drill bit, roughening tool, dispenser, piston plug											

a) For anchors in diamond drilled holes, load values for combined pull-out and concrete cone resistance have to be reduced (see section "Setting instruction")

### Associated components for the use of Hilti Roughening tool TE-YRT

Diamond coring		Roughening tool TE-YRT	Wear gauge RTG...
$d_o$ [mm]		$d_o$ [mm]	size
Nominal	measured		
18	17,9 to 18,2	18	18
20	19,9 to 20,2	20	20
22	21,9 to 22,2	22	22
25	24,9 to 25,2	25	25
28	27,9 to 28,2	28	28
30	29,9 to 30,2	30	30
32	31,9 to 32,2	32	32
35	34,9 to 35,2	35	35

**Minimum roughening time  $t_{\text{roughen}}$  ( $t_{\text{roughen}} [\text{sec}] = h_{\text{ef}} [\text{mm}] / 10$ )**

$h_{\text{ef}} [\text{mm}]$	$t_{\text{roughen}} [\text{sec}]$
0 to 100	10
101 to 200	20
201 to 300	30
301 to 400	40
401 to 500	50
501 to 600	60

**Setting details**

Anchor size		Ø8	Ø10	Ø12		Ø14	Ø16	Ø20	Ø25	Ø28	Ø30	Ø32	Ø36	Ø40
Nominal diameter of drill bit	$d_0$ [mm]	10 12 <sup>a)</sup>	12 14 <sup>a)</sup>	14 <sup>a)</sup>	16 <sup>a)</sup>	18	20	25	30 32 <sup>a)</sup>	35	37	40	45 <sup>1)</sup>	55 <sup>1)</sup>
Effective anchorage and drill hole depth	$h_{\text{ef,min}}$ [mm]	60	60	70	70	75	80	90	100	112	120	128	144 <sup>1)</sup>	160 <sup>1)</sup>
	$h_{\text{ef,max}}$ [mm]	160	200	240	240	280	320	400	500	560	600	640	720 <sup>1)</sup>	800 <sup>1)</sup>
Minimum base material thickness	$h_{\text{min}}$ [mm]	$h_{\text{ef}} + 30 \text{ mm} \geq 100 \text{ mm}$				$h_{\text{ef}} + 2 d_0$								
Minimum spacing	$s_{\text{min}}$ [mm]	40	50	60	60	70	80	100	125	140	150	160	180 <sup>1)</sup>	200 <sup>1)</sup>
Minimum edge	$c_{\text{min}}$ [mm]	40	45	45	45	50	50	65	70	75	80	80	180 <sup>1)</sup>	200 <sup>1)</sup>
Critical spacing for splitting failure	$s_{\text{cr,sp}}$ [mm]	$2 c_{\text{cr,sp}}$												
Critical edge distance for splitting failure <sup>c)</sup>	$c_{\text{cr,sp}}$ [mm]	$1,0 \cdot h_{\text{ef}}$ for $h / h_{\text{ef}} \geq 2,0$												
		$4,6 h_{\text{ef}} - 1,8 h$ for $2,0 > h / h_{\text{ef}} > 1,3$												
		$2,26 h_{\text{ef}}$ for $h / h_{\text{ef}} \leq 1,3$												
Critical spacing for concrete cone failure	$s_{\text{cr,N}}$ [mm]	$2 c_{\text{cr,N}}$												
Critical edge distance for concrete cone failure <sup>d)</sup>	$c_{\text{cr,N}}$ [mm]	$1,5 h_{\text{ef}}$												





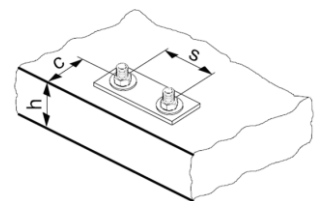

1) Additional Hilti Technical data

For spacing (edge distance) smaller than critical spacing (critical edge distance) the design loads have to be reduced.

- both given values for drill bit diameter can be used
- $h_{\text{ef,min}} \leq h_{\text{ef}} \leq h_{\text{ef,max}}$  ( $h_{\text{ef}}$ : embedment depth)
- $h$ : base material thickness ( $h \geq h_{\text{min}}$ )
- The critical edge distance for concrete cone failure depends on the embedment depth  $h_{\text{ef}}$  and the design bond resistance. The simplified formula given in this table is on the safe side



**Drilling and cleaning diameters**

Rebar - size	Hammer drill (HD)	Hollow Drill Bit (HDB)	Diamond coring		Brush HIT-RB	Piston plug HIT-SZ
			Diamond coring (DD)	With roughening tool (RT)		
	d <sub>0</sub> [mm]				size [mm]	
						
φ8	12 (10 <sup>a</sup> )	-	12 (10 <sup>a</sup> )	-	12 (10 <sup>a</sup> )	12
φ10	14 (12 <sup>a</sup> )	14	14 (12 <sup>a</sup> )	-	14 (12 <sup>a</sup> )	14 (12 <sup>a</sup> )
φ12	16 (14 <sup>a</sup> )	16 (14 <sup>a</sup> )	16 (14 <sup>a</sup> )	-	16 (14 <sup>a</sup> )	16 (14 <sup>a</sup> )
φ14	18	18	18	18	18	18
φ16	20	20	20	20	20	20
φ20	25	25	25	25	25	25
φ25	32	32	32	32	32	32
φ28	35	35	35	35	35	35
φ30	37	-	37	-	37	37
φ32	40	-	-	-	40	40
	-	-	42	-	42	42
φ36	45 <sup>b</sup> )	-	-	-	45 <sup>b</sup> )	45 <sup>b</sup> )
φ40	55 <sup>b</sup> )	-	-	-	55 <sup>b</sup> )	55 <sup>b</sup> )

a) Each of two given values can be used

b) Additional Hilti technical data

**Setting instructions**

**\*For detailed information on installation see instruction for use given with the package of the product.**

**Safety regulations.**

Review the Material Safety Data Sheet (MSDS) before use for proper and safe handling! Wear well-fitting protective goggles and protective gloves when working with Hilti HIT-RE 500 V3.

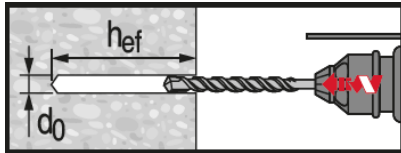
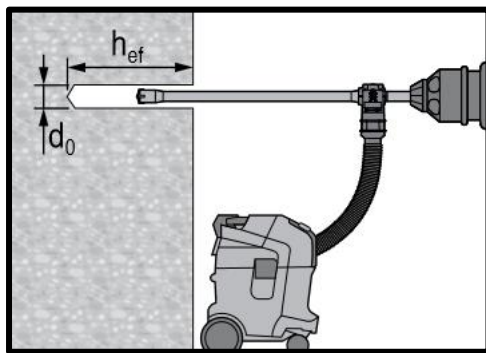
**Hammer drilled hole**

**Hammer drilled hole with Hollow Drilled Bit (HDB)**

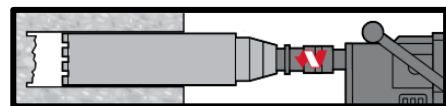
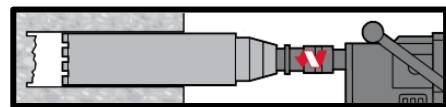
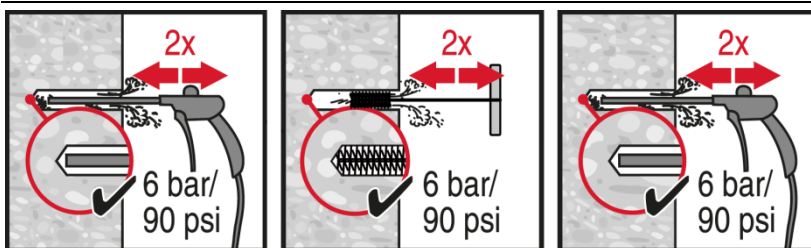
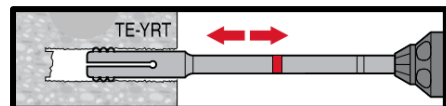
No cleaning required

**Diamond Coring**

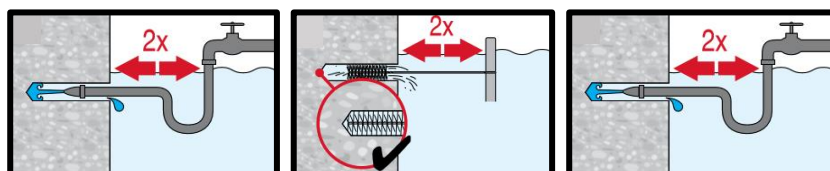
**Diamond Coring + Roughening Tool**

**Hammer Drilling:**
**Compressed air cleaning (CAC)**

for all drill hole diameters  $d_0$  and drill hole depths  $h_0 \leq 20 \cdot d$ .

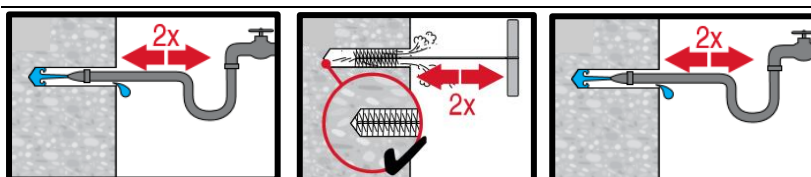
**Hammer drilling:**
**Cleaning for under water:**

For all bore hole diameters  $d_0$  and all bore hole depth  $h_0$ .

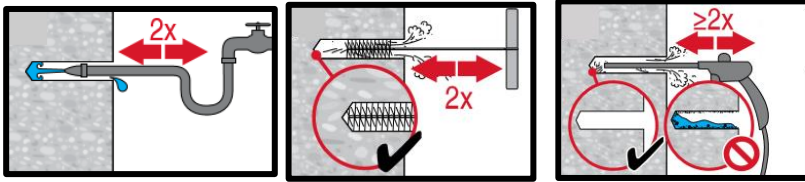
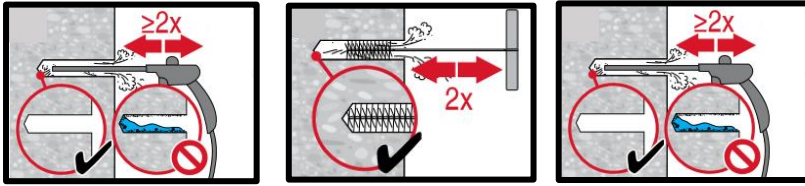

**Hammer drilled flooded holes and diamond cored holes:**
**Compressed air cleaning (CAC)**

for all drill hole diameters  $d_0$  and drill hole depths  $h_0$ .

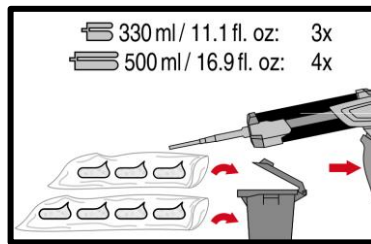
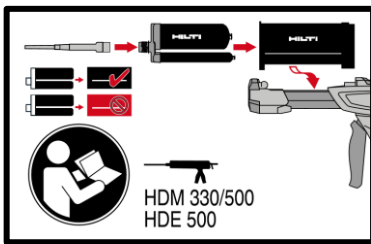

**Diamond cored holes with Hilti roughening tool:**

**Compressed air cleaning (CAC)** for all drill hole diameters  $d_0$  and drill hole depths  $h_0$ .



**Injection system preparation.**

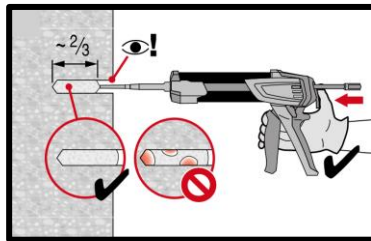
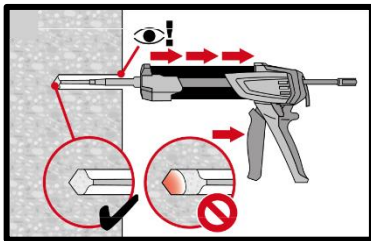

**Injection method for drill hole depth**  
 $h_{ef} \leq 250$  mm.

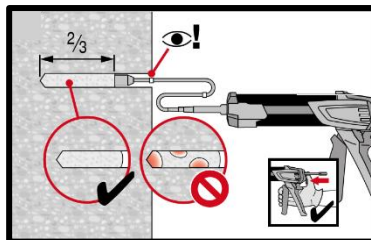
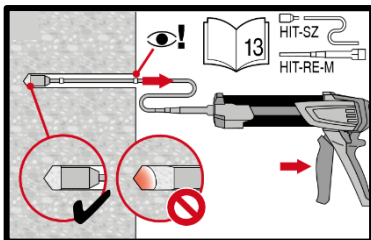

**Injection method for drill hole depth**  
 $h_{ef} > 250$  mm.

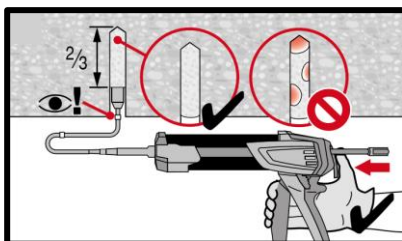
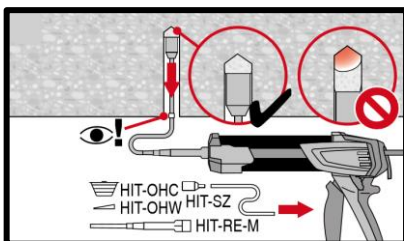

**Injection method for overhead application.**

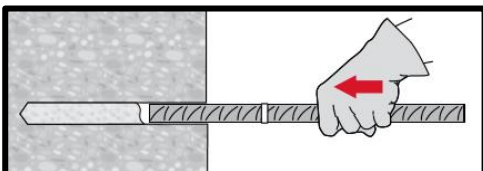

**Setting element**, observe working time " $t_{work}$ ",

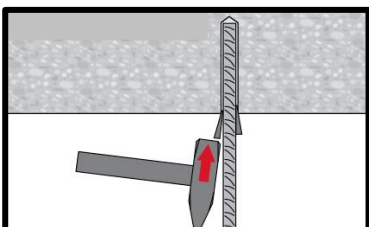

**Setting element** for overhead applications, observe working time " $t_{work}$ ",

**Loading the anchor:** After required curing time  $t_{cure}$  the anchor can be loaded.

# HIT-RE 500 V3 injection mortar

Rebar design (EN 1992-1-1) / Rebar elements / Concrete

## Injection mortar system



Foil pack: HIT-RE 500 V3  
(available in 330, 500  
and 1400 ml cartridges)



Rebar B500 B  
( $\phi 8 - \phi 40$ )

## Benefits

- **SafeSet** technology: Simplified method of borehole preparation using either Hilti hollow drill bit for hammer drilling or Roughening tool for diamond cored applications
- Suitable for concrete C 12/15 to C 50/60
- High loading capacity
- Suitable for dry and water saturated concrete
- Non-corrosive to rebar elements
- Long working time at elevated temperatures
- Cures down to  $-5^{\circ}\text{C}$
- Odourless epoxy
- Fire time exposure up to 4h

## Base material



Concrete  
(non-cracked)

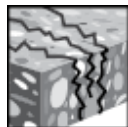

Concrete  
(cracked)



Dry concrete



Wet concrete



Static/  
quasi-static



Seismic



Fire  
resistance

## Load conditions

## Installation conditions

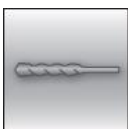

Hammer  
drilling



Diamond  
coring

**SAFESET**

Hilti **SafeSet**  
technology

## Other informations



European  
Technical  
Assessment



PROFIS  
Engineering  
design  
Software



PROFIS  
Rebar  
design  
Software

## Approvals / certificates

Description	Authority / Laboratory	No. / date of issue
European technical assessment <sup>a)</sup>	CSTB, Marne la Vallée	ETA-16/0142 / 2019-05-27
Fire evaluation	CSTB, Marne la Vallée	MRF 1526054277/B

a) All data given in this section according to ETA-16/0142 issue 2019-05-27.

**Static and quasi-static loading**
**Static design acc. to EN 1992-1-1**

 Design bond strength in N/mm<sup>2</sup> according to ETA 16/0142 for good bond conditions

All allowed hammer drilling methods and diamond coring with Hilti roughening tool TE-YRT									
Rebar - size	Concrete class								
	C12/15	C16/20	C20/25	C25/30	C30/37	C35/45	C40/50	C45/55	C50/60
φ8 - φ32	1,6	2,0	2,3	2,7	3,0	3,4	3,7	4,0	4,3
φ34	1,6	2,0	2,3	2,6	2,9	3,3	3,6	3,9	4,2
φ36	1,6	1,9	2,2	2,6	2,9	3,2	3,5	3,8	4,1
φ40	1,5	1,8	2,1	2,5	2,8	3,1	3,4	3,7	3,9
Diamond coring wet									
φ8 - φ12	1,6	2,0	2,3	2,7	3,0	3,4	3,7	4,0	4,0
φ14 - φ 16	1,6	2,0	2,3	2,7	3,0	3,4	3,7	3,7	3,7
φ18 - φ32	1,6	2,0	2,3	2,7	3,0	3,4	3,4	3,4	3,4
φ34	1,6	2,0	2,3	2,6	2,9	3,3	3,3	3,3	3,3
φ36	1,6	1,9	2,2	2,6	2,9	3,2	3,2	3,2	3,2
φ40	1,5	1,8	2,1	2,5	2,8	2,8	2,8	2,8	2,8

For poor bond conditions multiply the values by 0,7.

**Minimum anchorage length and minimum lap length**

 The minimum anchorage length  $\ell_{b,min}$  and the minimum lap length  $\ell_{0,min}$  according to EN 1992-1-1 shall be multiplied by relevant **Amplification factor  $\alpha_{lb}$**  in the table below.

**Amplification factor  $\alpha_{lb}$  for the min. anchorage length and min. lap length**

All allowed hammer drilling methods and diamond coring with Hilti roughening tool TE-YRT									
Rebar - size	Concrete class								
	C12/15	C16/20	C20/25	C25/30	C30/37	C35/45	C40/50	C45/55	C50/60
φ8 - φ40	1,0								
Diamond coring wet									
φ8 - φ12	1,0								
φ14 - φ36	Linear interpolation between diameters								
φ40	1,0	1,0	1,0	1,0	1,2	1,3	1,4	1,4	1,4



**Anchorage length for characteristic steel strength  $f_{yk}=500 \text{ N/mm}^2$  for good conditions**

Hammer drilling							
Rebar-size	Concrete class	$f_{bd}$	$l_{0,min}^{1)}$	$l_{b,min}^{2)}$	$l_{bd,y,\alpha_2=1}^{3)}$	$l_{bd,y,\alpha_2=0.7}^{4)}$	$l_{max}^{5)}$
		[N/mm <sup>2</sup> ]	[mm]	[mm]	[mm]	[mm]	[mm]
ϕ8	C20/25	2,3	200	113	378	265	1000
	C50/60	4,3	200	100	202	142	1000
ϕ10	C20/25	2,3	213	142	473	331	1000
	C50/60	4,3	200	100	253	177	1000
ϕ12	C20/25	2,3	255	170	567	397	1200
	C50/60	4,3	200	120	303	212	1200
ϕ14	C20/25	2,3	298	198	662	463	1400
	C50/60	4,3	210	140	354	248	1400
ϕ16	C20/25	2,3	340	227	756	529	1600
	C50/60	4,3	240	160	404	283	1600
ϕ20	C20/25	2,3	425	284	945	662	2000
	C50/60	4,3	300	200	506	354	2000
ϕ25	C20/25	2,3	532	354	1181	827	2500
	C50/60	4,3	375	250	632	442	2500
ϕ28	C20/25	2,3	595	397	1323	926	2800
	C50/60	4,3	420	280	708	495	2800
ϕ30	C20/25	2,3	638	425	1418	992	3000
	C50/60	4,3	450	300	758	531	3000
ϕ32	C20/25	2,3	681	454	1512	1059	3200
	C50/60	4,3	480	320	809	566	3200
ϕ36	C20/25	2,2	800	534	1779	1245	3200
	C50/60	4,1	540	360	954	668	3200
ϕ40	C20/25	2,1	932	621	2070	1449	3200
	C50/60	3,9	600	400	1115	780	3200

1) Minimum anchorage length for overlap joint in case of  $\alpha_6=1,5$

2) Minimum anchorage length for simply supported connections

3) Anchorage length for simply supported connections in case of:  $\alpha_1= \alpha_2= \alpha_3= \alpha_4= \alpha_5= 1$ . - (design for yielding)

4) Anchorage length for simply supported connections in case of:  $\alpha_1= \alpha_3= \alpha_4= \alpha_5= 1$ ;  $\alpha_2= 0.7$  - (design for yielding)

5) Maximum feasible embedment depth due to mortar installation limitations.



**Seismic loading**
**Seismic data according to ETA-16/0142**
**Design bond strength in N/mm<sup>2</sup> for good bond conditions**

All allowed hammer drilling methods, diamond coring dry and diamond coring with Hilti roughening tool TE-YRT								
Rebar - size	Concrete class							
	C16/20	C20/25	C25/30	C30/37	C35/45	C40/50	C45/55	C50/60
φ10 - φ32	2,0	2,3	2,7	3,0	3,4	3,7	4,0	4,3
φ34	2,0	2,3	2,6	2,9	3,3	3,6	3,9	4,2
φ36	1,9	2,2	2,6	2,9	3,2	3,5	3,8	4,1
φ40	1,8	2,1	2,5	2,8	3,1	3,4	3,7	3,9

For poor bond conditions multiply the values 0,7.

**Design bond strength in N/mm<sup>2</sup> for good bond conditions**

Diamond coring wet								
Rebar - size	Concrete class							
	C16/20	C20/25	C25/30	C30/37	C35/45	C40/50	C45/55	C50/60
φ12	2,0	2,3	2,7	3,0	3,4	3,7	4,0	4,0
φ14 - φ32	2,0	2,3	2,7	3,0	3,3	3,4	3,4	3,4
φ34	1,9	2,3	2,3	2,3	2,3	2,3	2,3	2,3
φ36	1,9	2,2	2,2	2,2	2,2	2,2	2,2	2,2
φ40	1,8	2,1	2,1	2,1	2,1	2,1	2,1	2,1

For poor bond conditions multiply the values 0,7.

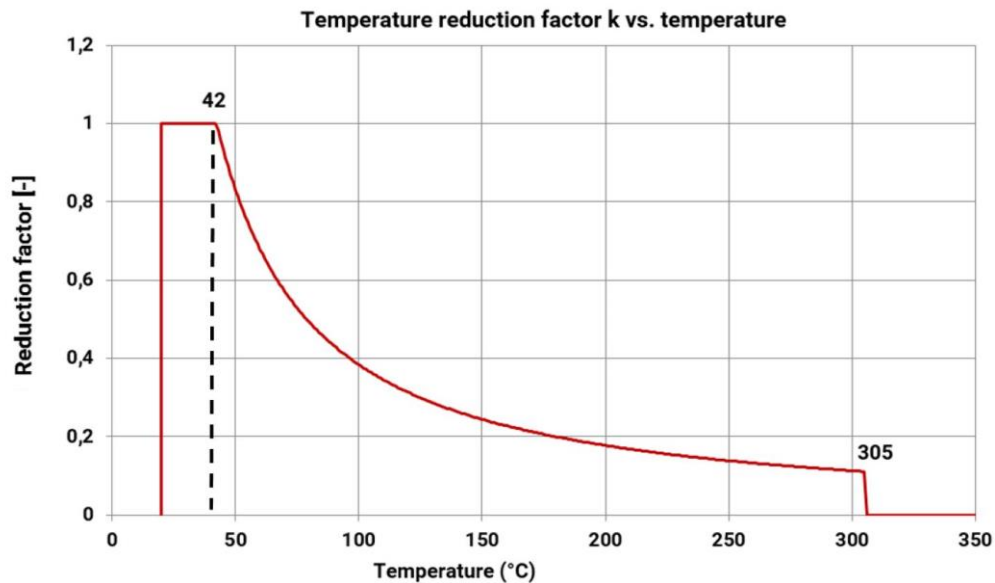
**Fire resistance**
**Temperature reduction factor  $k_{fi}(\theta)$** 

The design value of the bond resistance  $f_{bd,fi}$  under fire exposure has to be calculated by the following equation:

$$f_{bd,fi} = k_{b,fi}(\theta) \cdot f_{bd} \cdot \frac{\gamma_c}{\gamma_{M,fi}}$$

If  $\theta > 42^\circ\text{C}$ :

$$k_{b,fi}(\theta) = \frac{651.24 \cdot \theta^{-1.115}}{f_{bd} \cdot 4.3} \leq 1,0$$

If  $\theta > 305^\circ\text{C}$ :

$$k_{b,fi}(\theta) = 0.0$$

$f_{bd,fi}$  = Design value of the bond resistance in case of fire in N/mm<sup>2</sup>

$(\theta)$  = Temperature in °C in the mortar layer.

$k_{b,fi}(\theta)$  = Reduction factor under fire exposure.

$f_{bd,fi}(\theta)$  = Design value of the bond resistance in N/mm<sup>2</sup> in cold condition according to Table C2 or C3 considering the concrete classes, the rebar diameter, the drilling method and the bond conditions according to EN 1992-1-1.

$\gamma_c$  = Partial safety factor according to EN 1992-1-1

$\gamma_{M,fi}$  = Partial safety factor according to EN 1992-1-2

For evidence under fire exposure the anchorage length shall be calculated according to EN 1992-1-1:2004+AC:2010 Equation 8.3 using the temperature-dependent bond resistance  $f_{bd,fi}$ .

According to MRF 1526054277 / B

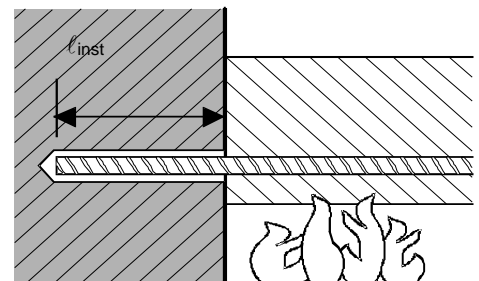
**a) Anchoring application**

**Anchoring application beam-wall connection with a concrete cover of 20 mm**
**Maximum force in rebar in conjunction with HIT-RE 500 V3 as a function of embedment depth for the fire resistance classes F30 to F240 (yield strength  $f_{yk} = 500 \text{ N/mm}^2$  and concrete class C20/25) according EC2**

Rebar-size	Max. $F_{s,T}$ [kN]	$l_{inst}$ [mm]	Fire resistance of bar in [kN]							
			R30	R60	R90	R120	R180	R240		
$\phi 8$	16,8	100	3,8	1,3	0,5	0,2	0,0	0,0		
		140	7,2	4,3	2,3	1,5	0,7	0,2		
		180	10,7	7,8	5,6	3,9	2,1	1,3		
		220	14,2	11,2	9,1	7,4	4,6	2,9		
		250	16,8	16,8	13,8	11,7	10,0	7,1	4,8	
		290			15,1	13,5	10,6	8,1		
		310			15,2	12,3	9,8			
		330			16,8	14,0	11,6			
		370				16,8	15,0			
		390			16,8	16,8				
$\phi 10$	26,2	110			5,8	2,4	1,1	0,6	0,0	0,0
		150			10,1	6,5	3,8	2,5	1,2	0,5
		190			14,5	10,8	8,1	6,0	3,3	2,0
		230			18,8	15,1	12,4	10,3	6,7	4,4
		300	26,2	26,2	22,7	20,0	17,9	14,3	11,2	
		340			24,3	22,2	18,6	15,6		
		360			24,4	20,8	17,7			
		380			26,2	23,0	19,9			
		410				26,2	23,1			
		440			26,2	26,2				
$\phi 12$	37,7	140			10,9	6,5	3,5	2,3	1,0	0,3
		200			18,7	14,3	11,0	8,5	4,8	3,0
		260			26,5	22,1	18,8	16,3	12,0	8,3
		320			34,3	29,9	26,6	24,1	19,8	16,1
		350	37,7	37,7	33,8	30,5	28,0	23,7	20,0	
		390			35,7	33,2	28,9	25,2		
		410			35,8	31,5	27,8			
		430			37,7	34,1	30,4			
		460				37,7	34,3			
		490			37,7	37,7				
$\phi 14$	51,3	160			15,7	10,6	6,7	4,4	2,3	1,1
		220			24,8	19,7	15,8	12,9	8,0	5,1
		280			33,9	28,8	24,9	22,0	17,0	12,7
		340			43,0	37,9	34,1	31,1	26,1	21,8
		400	51,3	51,3	47,0	43,2	40,2	35,2	30,9	
		430			47,7	44,8	39,7	35,4		
		460			49,3	44,3	40,0			
		480			51,3	47,3	43,0			
		510				51,3	47,6			
		540			51,3	51,3				
$\phi 16$	67	180			21,4	15,5	11,2	7,8	4,3	2,5
		240			31,8	25,9	21,6	18,2	12,5	8,2
		300			42,2	36,3	32,0	28,6	22,9	18,0
		360			52,6	46,8	42,4	39,0	33,3	28,4
		450	67,0	67,0	62,4	58,0	54,6	48,9	44,0	
		480			63,2	59,8	54,1	49,2		
		510			65,1	59,3	54,4			
		530			67,0	62,8	57,8			
		560				67,0	63,0			
		590			67,0	67,0				
$\phi 20$	104,7	220			35,5	28,1	22,6	18,5	11,4	7,3
		280			48,5	41,1	35,6	31,5	24,3	18,1
		340			61,5	54,1	48,6	44,5	37,3	31,1
		400			74,5	67,1	61,7	57,5	50,3	44,1
		460	87,5	80,1	74,7	70,5	63,3	57,1		
		540	104,7	97,5	92,0	87,8	80,6	74,5		

Maximum force in rebar in conjunction with HIT-RE 500 V3 as a function of embedment depth for the fire resistance classes F30 to F240 (yield strength  $f_{yk} = 500 \text{ N/mm}^2$  and concrete class C20/25) according EC2

Rebar-size	Max. $F_{s,T}$ [kN]	$l_{inst}$ [mm]	Fire resistance of bar in [kN]					
			R30	R60	R90	R120	R180	R240
		580			100,7	96,5	89,3	83,1
		600				100,8	93,6	87,5
		620		104,7			98,0	91,8
		660			104,7	104,7		100,5
		680					104,7	104,7

**Anchoring application beam-wall connection with a concrete cover of 40 mm**

Rebar-size	Max. F <sub>s,T</sub> [kN]	l <sub>inst</sub> [mm]	Fire resistance of bar in [kN]					
			R30	R60	R90	R120	R180	R240
ϕ8	16,8	100	4,9	1,8	0,8	0,4	0,0	0,0
		140	8,4	5,0	2,9	1,9	0,7	0,2
		180	11,9	8,5	6,2	4,5	2,3	1,3
		220	15,4	11,9	9,7	8,0	4,9	3,1
		240	16,8	13,7	11,4	9,7	6,6	4,3
		280		16,8	14,9	13,2	10,1	7,6
		310	16,8		16,8	16,8	15,8	12,7
		330		14,4			11,9	
		360	16,8	14,5				
		390	16,8	16,8				
ϕ10	26,2	110	7,3	3,1	1,5	0,9	0,0	0,0
		150	11,6	7,3	4,5	3,0	1,3	0,6
		190	15,9	11,7	8,9	6,7	3,5	2,1
		230	20,3	16,0	13,2	11,0	7,2	4,6
		290	26,2	22,5	19,7	17,5	13,7	10,5
		330		26,2	24,0	21,9	18,0	14,9
		350	26,2		26,2	26,2	24,0	20,2
		370		22,3			19,2	
		410	26,2	23,6				
		440	26,2	26,2				
ϕ12	37,7	140	12,6	7,5	4,3	2,8	1,1	0,3
		200	20,4	15,3	11,9	9,3	5,2	3,2
		260	28,2	23,1	19,7	17,1	12,5	8,8
		320	36,0	30,9	27,6	25,0	20,3	16,6
		340	37,7	33,5	30,2	27,6	22,9	19,2
		380		37,7	35,4	32,8	28,1	24,4
		400	37,7		37,7	37,7	35,4	30,7
		420		33,3			29,6	
		460	37,7	34,8				
		490	37,7	37,7				
ϕ14	51,3	160	17,8	11,8	7,9	5,2	2,5	1,2
		220	26,9	20,9	17,0	13,9	8,5	5,5
		280	36,0	30,0	26,1	23,0	17,6	13,2
		340	45,1	39,1	35,2	32,1	26,7	22,4
		390	51,3	46,7	42,8	39,7	34,3	29,9
		430		51,3	48,8	45,8	40,4	36,0
		450	51,3		51,3	51,3	48,8	43,4
		470		46,4			42,1	
		510	51,3	48,1				
		540	51,3	51,3				
ϕ16	67	180	23,8	16,9	12,5	9,0	4,6	2,7
		240	34,2	27,3	22,9	19,4	13,2	8,7
		300	44,6	37,7	33,3	29,8	23,6	18,6
		360	55,0	48,2	43,7	40,2	34,0	29,0
		430	67,0	60,3	55,8	52,3	46,1	41,2
		470		67,0	62,7	59,3	53,1	48,1
		500	67,0		67,0	67,0	64,5	58,3
		520		61,7			56,8	
		560	67,0	63,7				
		580	67,0	67,0				

Rebar-size	Max. F <sub>s,T</sub> [kN]	l <sub>inst</sub> [mm]	Fire resistance of bar in [kN]					
			R30	R60	R90	R120	R180	R240
φ20	104,7	220	38,4	29,8	24,2	19,9	12,2	7,8
		300	55,7	47,2	41,6	37,3	29,5	23,3
		380	73,1	64,5	58,9	54,6	46,8	40,6
		460	90,4	81,9	76,3	71,9	64,2	57,9
		530	104,7	97,0	91,4	87,1	79,3	73,1
		570		100,1	95,8	88,0	81,8	
		600	104,7	104,7	104,7	102,3	94,5	88,3
		620				98,9	92,6	
		650				104,7	104,7	
		680					104,7	104,7
φ25	163,6	280	64,2	53,6	46,6	41,1	31,4	23,7
		370	88,6	77,9	70,9	65,5	55,8	48,0
		460	113,0	102,3	95,3	89,9	80,2	72,4
		550	137,4	126,7	119,7	114,3	104,6	96,8
		650	163,6	153,8	146,8	141,4	131,7	123,9
		690		157,7	152,2	142,5	134,7	
		720	163,6	163,6	163,6	160,4	150,7	142,9
		740				156,1	148,3	
		770				163,6	156,4	
		800				163,6	163,6	
φ28	205,3	310	81,1	69,1	61,3	55,2	44,3	35,6
		370	99,3	87,3	79,5	73,4	62,5	53,8
		430	117,5	105,5	97,7	91,6	80,7	72,0
		490	135,7	123,7	115,9	109,8	98,9	90,2
		550	153,9	141,9	134,1	128,0	117,2	108,4
		610	172,1	160,1	152,3	146,2	135,4	126,6
		670	190,3	178,3	170,5	164,4	153,6	144,8
		720	205,3	193,5	185,7	179,6	168,7	160,0
		760		197,8	191,8	180,9	172,2	
		790		200,9	190,0	181,3		
		810	205,3	205,3	205,3	196,1	187,3	
		850				205,3	199,5	
		870				205,3	205,3	
φ32	268,1	350	106,5	92,8	83,9	76,9	64,5	54,6
		410	127,3	113,6	104,7	97,8	85,3	75,4
		470	148,1	134,5	125,5	118,6	106,1	96,2
		530	168,9	155,3	146,3	139,4	127,0	117,0
		590	189,7	176,1	167,1	160,2	147,8	137,8
		650	210,6	196,9	187,9	181,0	168,6	158,6
		710	231,4	217,7	208,7	201,8	189,4	179,4
		820	268,1	255,8	246,9	240,0	227,5	217,6
		860		260,8	253,8	241,4	231,4	
		890	268,1	268,1	268,1	264,2	251,8	241,8
		910				258,7	248,8	
		940				268,1	259,2	
		970				268,1	268,1	

## b) Overlap joint application

Max. bond stress,  $f_{bd,FIRE}$ , depending on actual clear concrete cover for classifying the fire resistance.

It must be verified that the actual force in the bar during a fire,  $F_{s,T}$ , can be taken up by the bar connection of the selected length,  $l_{inst}$ . Note: Cold design for ULS is mandatory.

$$F_{s,T} \leq (l_{inst} - c_f) \cdot \phi \cdot \pi \cdot f_{bd,FIRE} \quad \text{where: } (l_{inst} - c_f) \geq l_s;$$

$l_s$  = lap length

$\phi$  = nominal diameter of bar

$l_{inst} - c_f$  = selected overlap joint length; this must be at least  $l_s$ ,

but may not be assumed to be more than  $80 \phi$

$f_{bd,FIRE}$  = bond stress when exposed to fire

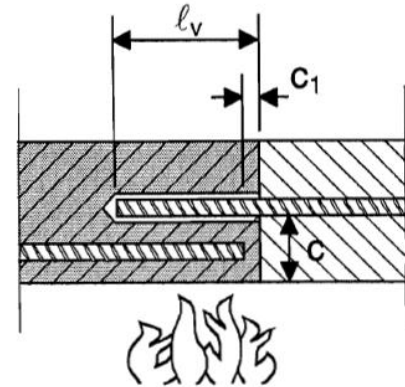

**Critical temperature-dependent bond stress,  $f_{bd,FIRE}$ , concerning “overlap joint” for Hilti HIT-RE 500 V3 injection adhesive in relation to fire resistance class and required minimum concrete coverage c.**

Clear concrete cover c [mm]	Max. bond stress, $\tau_c$ [N/mm <sup>2</sup> ]					
	R30	R60	R90	R120	R180	R240
30						
40	0,8					
50	1,1					
60	1,5					
70	2,1	0,9				
80	2,9	1,2				
90	3,5	1,5	0,9			
100		1,8	1,1	0,8		
110		2,3	1,4	1,0		
120		2,8	1,6	1,2		
130		3,4	2,0	1,4	0,9	
140		3,5	2,3	1,6	1,0	
150			2,8	1,9	1,1	0,8
160			3,3	2,2	1,3	0,9
170			3,5	2,5	1,5	1,1
180				2,9	1,7	1,2
190				3,4	1,9	1,4
200				3,5	2,2	1,5
210					2,5	1,7
220					2,8	1,9
230					3,1	2,1
240					3,5	2,3
250						2,6
260						2,9
270						3,2
280						3,5
290						

## Materials

### Properties of reinforcement

Designation	Material
Reinforcing bars (rebars)	
Rebar EN 1992-1-1	Bars and de-coiled rods class B or C with $f_{yk}$ and $k$ according to NDP or NCL of EN 1992-1-1 $f_{uk} = f_{tk} = k \cdot f_{yk}$

### Fitness for use

Some creep tests have been conducted in accordance with ETAG guideline 001 part 5 and TR 023 in the following conditions: **in dry environment at 50 °C during 90 days.**

These tests show an excellent behaviour of the post-installed connection made with HIT-RE 500 V3: low displacements with long term stability, failure load after exposure above reference load.

### Resistance to chemical substances

Chemicals tested	Content (%)	Resistance	Chemical tested	Content (%)	Resistance
Toluene	47,5	+	Sodium hydroxide 20%	100	-
Iso-octane	30,4	+	Triethanolamine	50	-
Heptane	17,1	+	Butylamine	50	-
Methanol	3	+	Benzyl alcohol	100	-
Butanol	2	+	Ethanol	100	-
Toluene	60	+	Ethyl acetate	100	-
Xylene	30	+	Methyl ethyl ketone (MEK)	100	-
Methylnaphthalene	10	+	Trichlorethylene	100	-
Diesel	100	+	Lutensit TC KLC 50	3	+
Petrol	100	+	Marlophen NP 9,5	2	+
Methanol	100	-	Water	95	+
Dichloromethane	100	-	Tetrahydrofurane	100	-
Mono-chlorobenzene	100	o	Demineralized water	100	+
Ethylacetat	50	-	Salt water	saturated	+
Methylisobutylketone	50	-	Salt spray testing	-	+
Salicylic acid-	50	+	SO <sub>2</sub>	-	+
Acetophenon	50	+	Enviroment/wheather	-	+
Acetic acid	50	-	Oil for formwork (forming oil)	100	+
Propionic acid	50	-	Concentrate plasticizer	-	+
Sulfuric acid	100	-	Concrete potash solution	-	+
Nitric acid	100	-	Concrete potash solution	-	+
Hydrochloric acid	36	-	Saturated suspension of borehole cuttings	-	+
Potassium hydroxide	100	-			

- + **Resistant**
- **Not resistant**
- o **Partially Resistant**

### Electrical Conductivity

HIT-RE 500 V3 in the hardened state **is not conductive electrically**. Its electric resistivity is  $66 \cdot 10^{12} \Omega \cdot m$  (DIN IEC 93 – 12.93). It is adapted well to realize electrically insulating anchorings (ex: railway applications, subway).

### Installation temperature range

-5°C to +40°C



### Service temperature range

Hilti HIT-RE 500 V3 injection mortar may be applied in the temperature ranges given below. An elevated base material temperature may lead to a reduction of the design bond resistance.

Temperature range	Base material temperature	Maximum long term base material temperature	Maximum short term base material temperature
Temperature range I	-40 °C to +80 °C	+50 °C	+80 °C

### Max short term base material temperature

Short-term elevated base material temperatures are those that occur over brief intervals, e.g. as result of diurnal cycling.

### Max long term base material temperature

Long-term elevated base material temperatures are roughly constant over significant periods of time.

### Working time and curing time <sup>1)</sup>

Temperature of the base material	Working time in which rebar can be inserted and adjusted $t_{gel}$	Initial curing time $t_{cure,ini}$	Curing time before rebar can be fully loaded $t_{cure}$
$5\text{ °C} \leq T_{BM} < -1\text{ °C}$	2 h	48 h	168 h
$0\text{ °C} \leq T_{BM} < 4\text{ °C}$	2 h	24 h	48 h
$5\text{ °C} \leq T_{BM} < 9\text{ °C}$	2 h	16 h	24 h
$10\text{ °C} \leq T_{BM} < 14\text{ °C}$	1,5 h	12 h	16 h
$15\text{ °C} \leq T_{BM} < 19\text{ °C}$	1 h	8 h	16 h
$20\text{ °C} \leq T_{BM} < 24\text{ °C}$	30 min	4 h	7 h
$25\text{ °C} \leq T_{BM} < 29\text{ °C}$	20 min	3,5 h	6 h
$30\text{ °C} \leq T_{BM} < 34\text{ °C}$	15 min	3 h	5 h
$35\text{ °C} \leq T_{BM} < 39\text{ °C}$	12 min	2 h	4,5 h
$T_{BM} = 40\text{ °C}$	10 min	2 h	4 h

1) The curing time data are valid for dry base material only. In wet base material the curing times must be doubled.

### Setting information

#### Installation equipment

Rebar – size	φ8	φ10	φ12	φ14	φ16	φ18	φ20	φ25	φ28	φ32	φ34	φ36	φ40
Rotary hammer	TE 2 (-A)– TE 40(-A)						TE40 – TE80						
	Blow out pump ( $h_{ef} \leq 10 \cdot d$ )						-						
Other tools	Compressed air gun <sup>a)</sup> Set of cleaning brushes <sup>b)</sup> , dispenser, piston plug Roughening tools												

a) Compressed air gun with extension hose for all drill holes deeper than 250 mm (for φ 8 to φ 12) or deeper than  $20 \cdot \phi$  (for φ > 12 mm)

b) Automatic brushing with round brush for all drill holes deeper than 250 mm (for φ 8 to φ 12) or deeper than  $20 \cdot \phi$  (for φ > 12 mm).

### Minimum concrete cover $c_{min}$ of the post-installed rebar



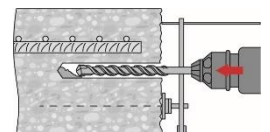

Drilling method	Bar diameter [mm]	Minimum concrete cover $c_{min}$ [mm]	
		Without drilling aid	With drilling aid
Hammer drilling (HD) and (HDB)	φ < 25	$30 + 0,06 \cdot l_v \geq 2 \cdot \phi$	$30 + 0,02 \cdot l_v \geq 2 \cdot \phi$
	φ ≥ 25	$40 + 0,06 \cdot l_v \geq 2 \cdot \phi$	$40 + 0,02 \cdot l_v \geq 2 \cdot \phi$
Compressed air drilling (CA)	φ < 25	$50 + 0,08 \cdot l_v$	$50 + 0,02 \cdot l_v$
	φ ≥ 25	$60 + 0,08 \cdot l_v \geq 2 \cdot \phi$	$60 + 0,02 \cdot l_v \geq 2 \cdot \phi$
Diamond coring in wet (PCC) dry (DD)	φ < 25	Drill stand works like a drilling aid	$30 + 0,02 \cdot l_v \geq 2 \cdot \phi$
	φ ≥ 25		$40 + 0,02 \cdot l_v \geq 2 \cdot \phi$
Diamond coring with Roughening too	φ < 25	$30 + 0,06 \cdot l_v \geq 2 \cdot \phi$	$30 + 0,02 \cdot l_v \geq 2 \cdot \phi$
	φ ≥ 25	$40 + 0,06 \cdot l_v \geq 2 \cdot \phi$	$40 + 0,02 \cdot l_v \geq 2 \cdot \phi$



**Dispenser and corresponding maximum embedment depth  $l_{v,max}$** 

Rebar – size [mm]	HDM 330, HDM 500	HDE 500
	$l_{v,max}$ [mm]	
φ8	1000	1000
φ10	1000	1000
φ12	1000	1200
φ14	1000	1400
φ16	1000	1600
φ18	700	1800
φ20	600	2000
φ22	500	1800
φ24	300	1300
φ25	300	1500
φ26	300	1000
φ28	300	1000
φ30	-	1000
φ32		700
φ34		600
φ36		600
φ40		400

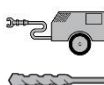
**Drilling diameters**

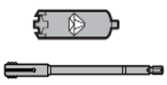
Rebar - size	Hammer drill (HD)	Hollow Drill Bit (HDB) <sup>b)</sup>	Compressed air drill (CA)	Diamond coring		
				Dry (PCC) <sup>b)</sup>	Wet (DD)	With roughening tool (RT) <sup>b)</sup>
$d_0$ [mm]						
						
φ8	12 (10 <sup>a)</sup> )	-	-	-	12 (10 <sup>a)</sup> )	-
φ10	14 (12 <sup>a)</sup> )	14 (12 <sup>a)</sup> )	-	-	14 (12 <sup>a)</sup> )	-
φ12	16 (14 <sup>a)</sup> )	16 (14 <sup>a)</sup> )	17	-	16 (14 <sup>a)</sup> )	-
φ14	18	18	17	-	18	18
φ16	20	20	20	-	20	20
φ18	22	22	22	-	22	22
φ20	25	25	26	-	25	25
φ22	28	28	28	-	28	28
φ24	32 (30 <sup>a)</sup> )	32 (30 <sup>a)</sup> )	32	-	32	32
φ25	32 (30 <sup>a)</sup> )	32 (30 <sup>a)</sup> )	32	-	32	32
φ26	35	35	35	35	35	35
φ28	35	35	35	35	35	35
φ30	37	-	37	35	37	-
φ32	40	-	40	47	40	-
φ34	45	-	42	47	45	-
φ36	45	-	45	47	47	-
φ40	55	-	57	52	52	-

a) Each of two given values can be used.

b) No cleaning required.

**Associated components for the use of Hilti Roughening tool TE-YRT**

Diamond coring		Roughening tool TE-YRT	Wear gauge RTG...
$d_0$ [mm]		$d_0$ [mm]	size
Nominal	measured		
18	17,9 to 18,2	18	18
20	19,9 to 20,2	20	20
22	21,9 to 22,2	22	22
25	24,9 to 25,2	25	25
28	27,9 to 28,2	28	28
30	29,9 to 30,2	30	30
32	31,9 to 32,2	32	32
35	34,9 to 35,2	35	35

**Minimum roughening time  $t_{\text{roughen}}$  ( $t_{\text{roughen}} [\text{sec}] = h_{\text{ef}} [\text{mm}] / 10$ )**

$h_{\text{ef}}$ [mm]	$t_{\text{roughen}}$ [sec]
0 to 100	10
101 to 200	20
201 to 300	30
301 to 400	40
401 to 500	50
501 to 600	60

**Setting instructions**

\*For detailed information on installation see instruction for use given with the package of the product.

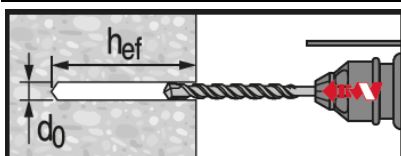
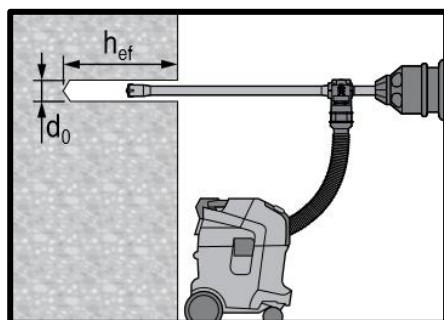

**Safety regulations.**

Review the Material Safety Data Sheet (MSDS) before use for proper and safe handling! Wear well-fitting protective goggles and protective gloves when working with Hilti HIT-RE 500 V3.

**Hammer drilled hole (HD)**

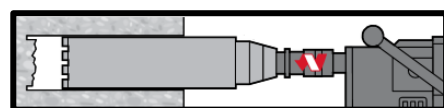
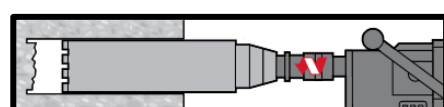
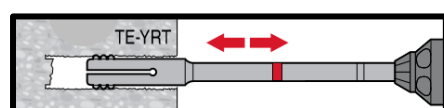
**Hammer drilled hole with Hollow Drilled Bit (HDB)**

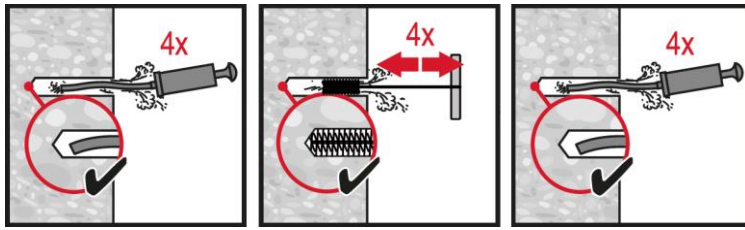
No cleaning required



**Diamond Drilling (DD)**

**Diamond Drilling + Roughening Tool (DD+RT)**

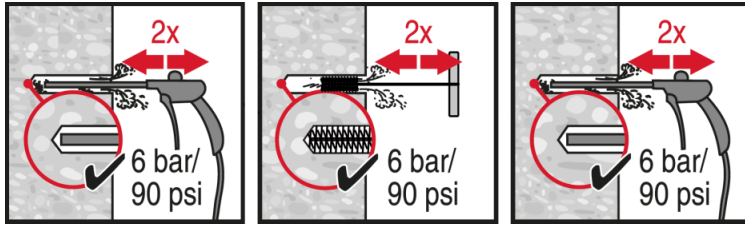

**Hammer Drilling:**

**Manual cleaning (MC)**

for drill diameters  $d_0 \leq 20$  mm and drill hole depth  $h_0 \leq 10 \cdot d$ .



**Hammer Drilling:**

**Compressed air cleaning (CAC)**

for all drill hole diameters  $d_0$  and drill hole depths  $h_0 \leq 20 \cdot d$ .

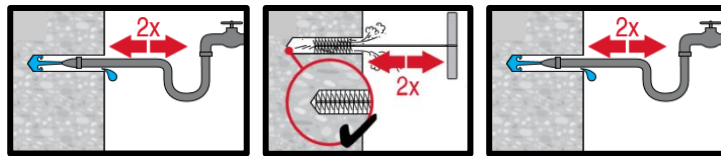

**Diamond cored holes:**

**Compressed air cleaning (CAC)**

for all drill hole diameters  $d_0$  and drill hole depths  $h_0$ .

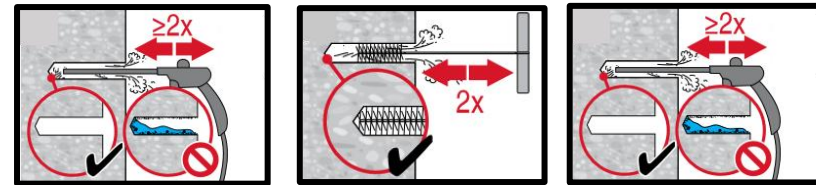

**Diamond cored holes with Hilti roughening tool:**

**Compressed air cleaning (CAC)**

for all drill hole diameters  $d_0$  and drill hole depths  $h_0$ .

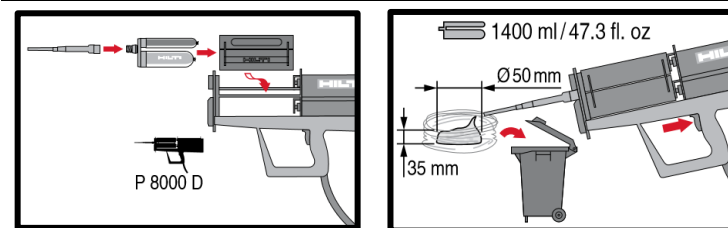
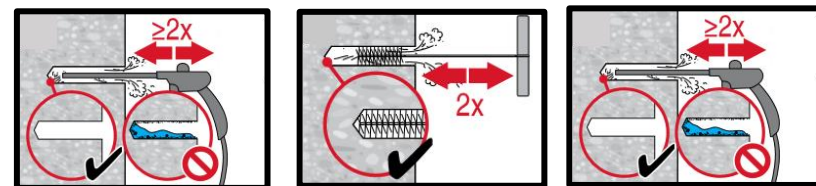

**Injection system preparation.**

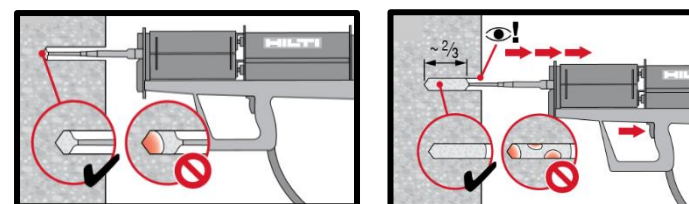

**Injection method for drill hole depth**

$h_{ef} \leq 250$  mm.

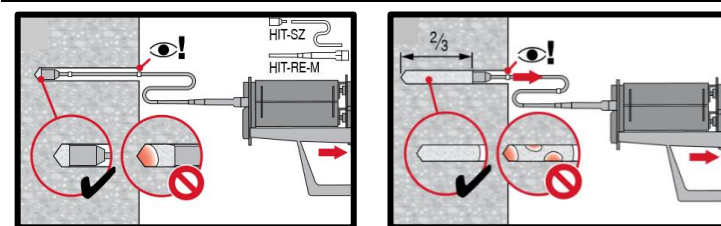

**Injection method for drill hole depth**

$h_{ef} > 250$  mm.

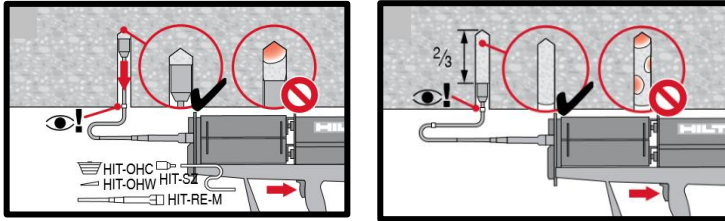

**Injection** method for overhead application.

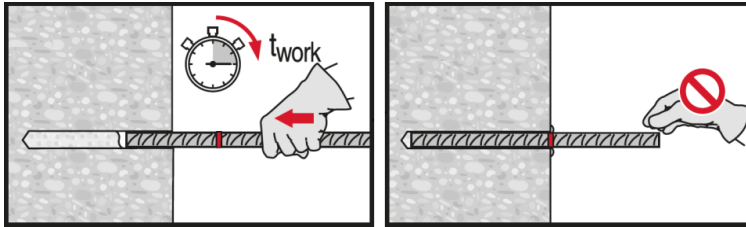

**Setting element**, observe working time "t<sub>work</sub>".

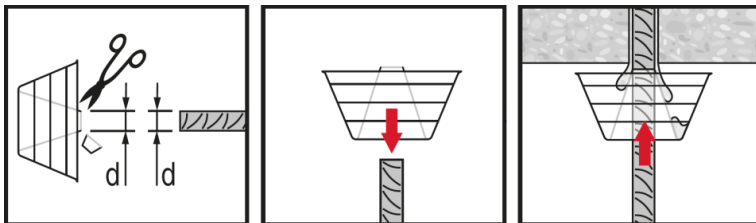

**Setting element** for overhead applications, observe working time "t<sub>work</sub>".

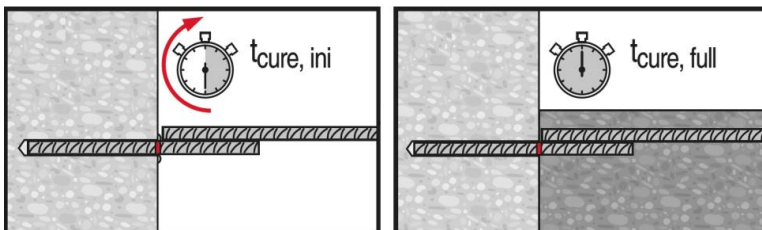
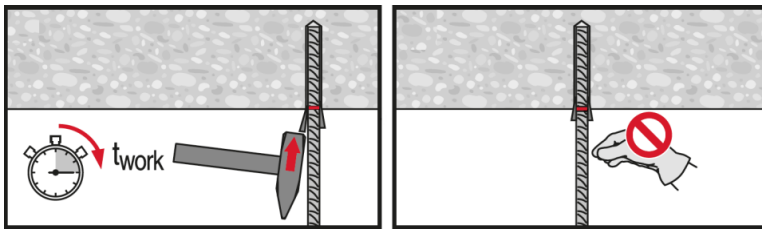

Apply full load only after curing time "t<sub>cure</sub>".

## 2.1.5 HIT-FP 700 R

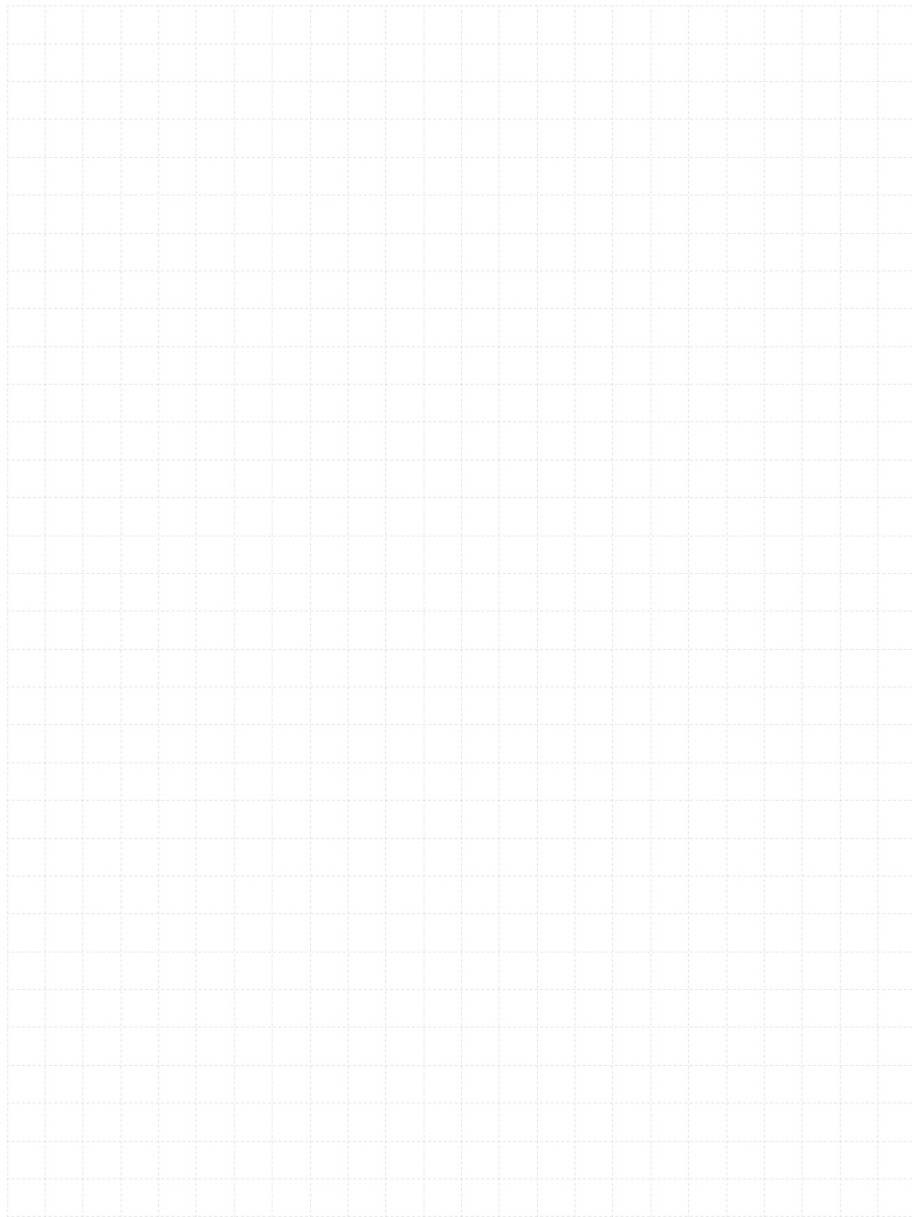

# HIT-FP 700 R injection mortar

Rebar design (EN 1992-1-1) / Rebar elements / Concrete

## Injection mortar system



Foil pack: HIT-FP 700 R  
(available in 490 ml cartridges)



Rebar  
( $\phi 8$  -  $\phi 40$ )

## Benefits

- **SafeSet** technology: Simplified method of borehole preparation using either Hilti hollow drill bit for hammer drilling or Roughening tool for diamond cored applications
- Suitable for concrete C12/15 to C50/60
- ETA Data for 100 years working life
- High resistance at elevated temperatures
- Suitable for dry and water saturated concrete
- Non-corrosive to rebar elements

## Base material



Concrete  
(non-cracked)



Concrete  
(cracked)

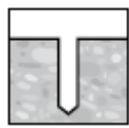

Dry concrete



Wet  
concrete

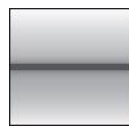

Static/  
quasi-static



Fire  
resistance

**100**  
YEARS

Working life  
100 years

## Load conditions

## Installation conditions

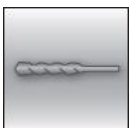

Hammer  
drilling



Diamond  
coring<sup>a)</sup>



Hilti **SafeSet**  
technology

## Other informations



European  
Technical  
Assessment



CE  
conformity



PROFIS  
Design  
Software

<sup>a)</sup> Diamond drilling only with Roughening Tool (RT)

## Approvals / certificates

Description	Authority / Laboratory	No. / date of issue
European technical assessment <sup>b)</sup>	CSTB, Marne la Vallée	ETA-21/0624 / 2022-06-17

<sup>b)</sup> All data given in this section according to ETA-21/0624 issue 2022-06-17 (if not stated otherwise).



**Static and quasi-static loading**
**Static design acc. to EN 1992-1-1**
**Design bond strength in N/mm<sup>2</sup> for good bond conditions for service life of 50 and 100 years<sup>1)</sup>**
**For hammer drilled holes, hammer drilled holes with hollow drill bit<sup>2)</sup> and diamond cored with Hilti roughening tool TE-YRT<sup>3)</sup>:**

Rebar size	ETA 21/0624, issued 2022-06-17								
	Concrete class								
	C12/15	C16/20	C20/25	C25/30	C30/37	C35/45	C40/50	C45/55	C50/60
φ 8	1,6	1,6	1,6	1,6	1,6	1,6	1,6	1,6	1,6
φ 10	1,6	2,0	2,0	2,0	2,0	2,0	2,0	2,0	2,0
φ 12	1,6	2,0	2,3	2,3	2,3	2,3	2,3	2,3	2,3
φ 14	1,6	2,0	2,3	2,3	2,3	2,3	2,3	2,3	2,3
φ 16	1,6	2,0	2,3	2,7	2,7	2,7	2,7	2,7	2,7
φ 18	1,6	2,0	2,3	2,7	2,7	2,7	2,7	2,7	2,7
φ 20	1,6	2,0	2,3	2,7	2,7	2,7	2,7	2,7	2,7
φ 22	1,6	2,0	2,3	2,7	2,7	2,7	2,7	2,7	2,7
φ 25	1,6	2,0	2,3	2,7	2,7	2,7	2,7	2,7	2,7
φ 26	1,6	2,0	2,3	2,3	2,3	2,3	2,3	2,3	2,3
φ 28	1,6	2,0	2,3	2,3	2,3	2,3	2,3	2,3	2,3
φ 30	1,6	2,0	2,3	2,3	2,3	2,3	2,3	2,3	2,3
φ 32	1,6	2,0	2,3	2,3	2,3	2,3	2,3	2,3	2,3
φ 34	1,6	2,0	2,0	2,0	2,0	2,0	2,0	2,0	2,0
φ 36	1,5	1,9	1,9	1,9	1,9	1,9	1,9	1,9	1,9
φ 40	1,5	1,8	2,1	2,1	2,1	2,1	2,1	2,1	2,1

- <sup>1)</sup> For poor bond conditions multiply the values by 0,7.  
<sup>2)</sup> Hilti hollow drill bit available for element size φ8-φ28.  
<sup>3)</sup> Roughening tools are available for element size φ14-φ28.

**Minimum anchorage length and minimum lap length**

 The minimum anchorage length  $\ell_{b,min}$  and the minimum lap length  $\ell_{0,min}$  according to EN 1992-1-1 shall be multiplied by relevant **Amplification factor  $\alpha_{lb}$**  in the table below.

**Amplification factor  $\alpha_{lb}$  for the min. anchorage length and min. lap length:**
**Hammer drilled holes, hammer drilled holes with hollow drill bit<sup>1)</sup> and diamond cored with Hilti roughening tool TE-YRT<sup>2)</sup>**

Rebar size	ETA 21/0624, issued 2022-06-17								
	Concrete class								
	C12/15	C16/20	C20/25	C25/30	C30/37	C35/45	C40/50	C45/55	C50/60
<b>φ8 - φ40</b>	1,5								

- <sup>1)</sup> Hilti hollow drill bit available for element size φ8-φ28.  
<sup>2)</sup> Roughening tools are available for element size φ14-φ28.



**Fire resistance**

**Example graph of temperature reduction factor  $k_{fi}(\theta)$  for concrete class C20/25 for good bond conditions according to ETA-21/0624 for working life of 50 and 100 years<sup>1)</sup>**

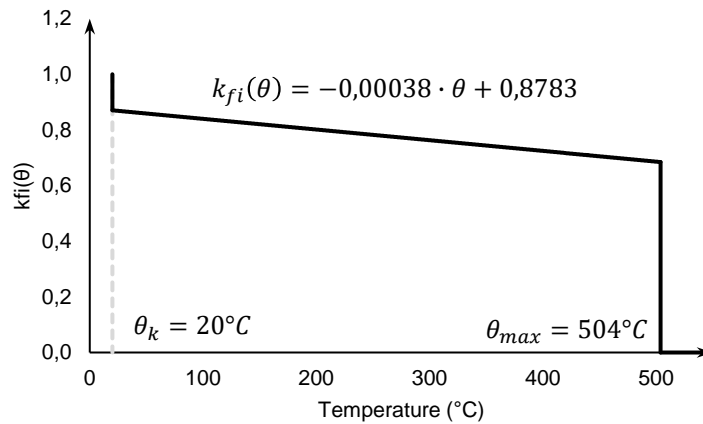

The design value of the bond resistance  $f_{bd,fi}$  under fire exposure has to be calculated by the following equation:

$$f_{bd,fi} = k_{b,fi}(\theta) \cdot f_{bd,PIR} \cdot \frac{\gamma_c}{\gamma_{M,fi}} \quad \text{for a working life of 50 years}$$

$$f_{bd,fi,100y} = k_{b,fi,100y}(\theta) \cdot f_{bd,PIR,100y} \cdot \frac{\gamma_c}{\gamma_{M,fi}} \quad \text{for a working life of 100 years}$$

with  $\theta \leq 504^\circ\text{C}$ :  $k_{b,fi}(\theta) = \frac{-0,0038 \cdot \theta + 8,6867}{f_{bd,PIR} \cdot 4,3} \leq 1,0$  for a working life of 50 years

$$k_{b,fi,100y}(\theta) = \frac{-0,0038 \cdot \theta + 8,6867}{f_{bd,PIR,100y} \cdot 4,3} \leq 1,0 \quad \text{for a working life of 100 years}$$

$$\theta > 504^\circ\text{C}: \quad k_{b,fi}(\theta) = k_{b,fi,100y}(\theta) = 0,0$$

$f_{bd,fi}$	Design value of the bond strength in case of fire in N/mm <sup>2</sup> for a working life of 50 years.
$f_{bd,fi,100y}$	Design value of the bond strength in case of fire in N/mm <sup>2</sup> for a working life of 100 years.
$(\theta)$	Temperature in °C in the mortar layer.
$\theta_{max}$	Temperature in °C at which the mortar can no longer transfer bond stresses
$k_{b,fi}(\theta)$	Reduction factor under fire exposure for a working life of 50 years.
$k_{b,fi,100y}(\theta)$	Reduction factor under fire exposure for a working life of 100 years.
$f_{bd,PIR}$	Design value of the bond strength in N/mm <sup>2</sup> in cold condition according to Table C3 or Table C6 considering the concrete classes, the rebar diameter, the drilling method and the bond conditions according to EN 1992-1-1 for a working life of 50 years.
$f_{bd,PIR,100y}$	Design value of the bond strength in N/mm <sup>2</sup> in cold condition according to Table C3 or Table C6 considering the concrete classes, the rebar diameter, the drilling method and the bond conditions according to EN 1992-1-1 for a working life of 100 years.
$\gamma_c$	Partial factor according to EN 1992-1-1.
$\gamma_{M,fi}$	Partial factor according to EN 1992-1-2.

For evidence under fire exposure the anchorage length shall be calculated according to EN 1992-1-1:2004+AC:2010 Equation 8.3 using the temperature-dependent bond resistance  $f_{bd,fi}$ .

## Materials

### Material quality

Part	Material
Rebar EN 1992-1-1	Bars and de-coiled rods class B or C with $f_{yk}$ and $k$ according to NDP or NCL of EN 1992-1-1 $f_{uk} = f_{tk} = k \cdot f_{yk}$

### Fitness for use

Some creep tests have been conducted in accordance with EAD 330087 in the following conditions: **in dry environment at 100 °C for 180 days.**

These tests show an excellent behaviour of the post-installed connection made with HIT-FP 700 R: low displacements with long term stability, failure load after exposure above reference load.

### Setting information

#### Installation temperature

+5 °C to +40 °C

#### Service temperature range

Hilti HIT-FP 700 R injection mortar may be applied in the temperature ranges given below. An elevated base material temperature may lead to a reduction of the design bond resistance.

Temperature range	Base material temperature	Maximum long term base material temperature	Maximum short term base material temperature
Temperature range I	-40 °C to +160 °C	+100 °C	+160 °C

#### Maximum short term base material temperature

Short-term elevated base material temperatures are those that occur over brief intervals, e.g. as result of diurnal cycling.

#### Maximum long term base material temperature

Long-term elevated base material temperatures are roughly constant over significant periods of time.

### Working time, assembly, pre-loading time and curing time<sup>1)</sup>

Temperature in the base material	Maximum working time	Assembly time	Pre-loading time	Minimum curing time
T [°C]	$t_{work}$	$t_{assembly}$	$t_{pre-loading}$	$t_{cure}$
$5 \leq T \leq 10$	50 min	36 hours	14 days	50 days
$10 < T \leq 15$	40 min	30 hours	7 days	28 days
$15 < T \leq 20$	35 min	24 hours	6 days	18 days
$20 < T \leq 30$	20 min	12 hours	5 days	10 days
$30 < T < 40$	15 min	6 hours	3 days	7 days
40	12 min	3 hours	2 days	4 days

<sup>1)</sup> The minimum temperature of the foil pack is +5° C.

**Working time, assembly, pre-loading time and curing time definition**

<p><b>t<sub>work</sub></b>: describes the working time, or the period in which the mortar has not yet solidified and in which the user can insert the rebar. The working time ranges from a maximum of 50 minutes at 5°C to a minimum of 12 minutes at 40°C. The long working time allows an easy setting for deep embedment. Once the rebar is inserted it must not be moved.</p>	
<p><b>t<sub>assembly</sub></b>: when t<sub>work</sub> has passed, t<sub>assembly</sub> indicates the minimum waiting time before tying new rebars to the installed/set ones or pouring new concrete is allowed.</p>	
<p><b>t<sub>pre-loading</sub></b>: It is the minimum waiting time needed before 75% of the final load can be applied to the set rebar. The t<sub>pre-loading</sub> is provided as additional guidance. However, the Engineer of Record must use their engineering judgment to decide whether or not pre-loading can be done prior to reaching the full curing time.</p>	
<p><b>t<sub>cure</sub></b>: the full curing time has passed and the full design load can be applied to the rebar.</p>	

**Installation equipment**

Rebar size	φ8	φ10	φ12	φ13	φ14	φ16	φ18	φ20	φ24	φ25	φ28	φ32	φ34	φ36	φ40	
Rotary hammer	TE 2(-A) – TE 30(-A)						TE30 – TE80									
	Blow out pump (h <sub>ef</sub> ≤ 10·d)						-									
Other tools	Compressed air gun <sup>a)</sup> Set of cleaning brushes <sup>b)</sup> , dispenser, piston plug Roughening tools															

<sup>a)</sup> Compressed air gun with extension hose for all drill holes deeper than 250 mm (for φ 8 to φ 12) or deeper than 20·φ (for φ > 12 mm).

<sup>b)</sup> Automatic brushing with round brush for all drill holes deeper than 250 mm (for φ 8 to φ 12) or deeper than 20·φ (for φ > 12 mm).

**Minimum concrete cover c<sub>min</sub> of the post-installed rebar**

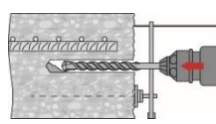
Drilling method	Rebar size	Minimum concrete cover c <sub>min</sub> [mm]		
		Without drilling aid	With drilling aid	
Hammer drilling (HD) and (HDB) <sup>c)</sup>	φ < 25	30 + 0,06 · l <sub>v</sub> ≥ 2 · φ	30 + 0,02 · l <sub>v</sub> ≥ 2 · φ	
	φ ≥ 25	40 + 0,06 · l <sub>v</sub> ≥ 2 · φ	40 + 0,02 · l <sub>v</sub> ≥ 2 · φ	
Diamond coring with Roughening tool TE-YRT (RT)	φ < 25	30 + 0,06 · l <sub>v</sub> ≥ 2 · φ	30 + 0,02 · l <sub>v</sub> ≥ 2 · φ	
	φ ≥ 25	40 + 0,06 · l <sub>v</sub> ≥ 2 · φ	40 + 0,02 · l <sub>v</sub> ≥ 2 · φ	



<sup>c)</sup> HDB = hollow drill bit Hilti TE-CD and TE-YD

Comments: The minimum concrete cover acc. EN 1992-1-1 must be observed.

**Dispenser and corresponding maximum embedment depth  $l_{v,max}$** 

Rebar Size	HDM 500	HDE 500
	$l_{v,max}$ [mm]	
$\phi$ 8 - 10	1000	1000
$\phi$ 12		1200
$\phi$ 14		1400
$\phi$ 16		1600
$\phi$ 18		1800
$\phi$ 20	1400	2000
$\phi$ 22		2200
$\phi$ 24		2400
$\phi$ 25	1500	2500
$\phi$ 26	1200	
$\phi$ 30		
$\phi$ 32		
$\phi$ 36	900	
$\phi$ 40	500	

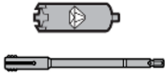

**Drilling diameters**

Rebar size	Hammer drill (HD)	Hollow Drill Bit (HDB) <sup>b)</sup>	Diamond coring with roughening tool (RT)
	$d_0$ [mm]		
			
$\phi$ 8	12 (10 <sup>a)</sup> )	12	-
$\phi$ 10	14 (12 <sup>a)</sup> )	14 (12 <sup>a)</sup> )	-
$\phi$ 12	16 (14 <sup>a)</sup> )	16 (14 <sup>a)</sup> )	-
$\phi$ 14	18	18	18
$\phi$ 16	20	20	20
$\phi$ 18	22	22	22
$\phi$ 20	25	25	25
$\phi$ 22	28	28	28
$\phi$ 24	32 (30 <sup>a)</sup> )	32	32
$\phi$ 25	32 (30 <sup>a)</sup> )	32	32
$\phi$ 26	35	35	35
$\phi$ 28	35	35	35
$\phi$ 30	37	-	-
$\phi$ 32	40	-	-
$\phi$ 34	45	-	-
$\phi$ 36	45	-	-
$\phi$ 40	55	-	-

<sup>a)</sup> Each of two given values can be used.

<sup>b)</sup> No cleaning required.

**Associated components for the use of Hilti Roughening tool TE-YRT**

Diamond coring		Roughening tool TE-YRT	Wear gauge RTG...
			
d <sub>0</sub> [mm]		d <sub>0</sub> [mm]	size
nominal	measured		
18	17,9 to 18,2	18	18
20	19,9 to 20,2	20	20
22	21,9 to 22,2	22	22
25	24,9 to 25,2	25	25
28	27,9 to 28,2	28	28
30	29,9 to 30,2	30	30
32	31,9 to 32,2	32	32
35	34,9 to 35,2	35	35

**Installation parameters for use of the Hilti Roughening tool TE-YRT**

l <sub>v</sub> [mm]	Roughening time	Minimum blowing time
	t <sub>roughen</sub>	t <sub>blowing</sub>
	t <sub>roughen</sub> [sec] = l <sub>v</sub> [mm] / 10	t <sub>blowing</sub> [sec] = t <sub>roughen</sub> [sec] + 20
0 to 100	10	30
101 to 200	20	40
201 to 300	30	50
301 to 400	40	60
401 to 500	50	70
501 to 600	60	80
> 600	t <sub>roughen</sub> [sec] = l <sub>v</sub> [mm] / 10	t <sub>blowing</sub> [sec] = t <sub>roughen</sub> [sec] + 20

## Setting instructions

\*For detailed information on installation see instruction for use given with the package of the product.

### Safety regulations.

Review the Material Safety Data Sheet (MSDS) before use for proper and safe handling! Wear well-fitting protective goggles and protective gloves when working with Hilti HIT-FP 700 R.

### Drilling

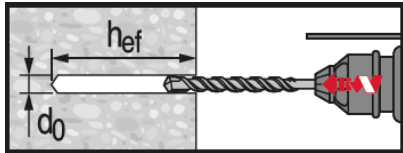

Hammer drilled hole (HD)

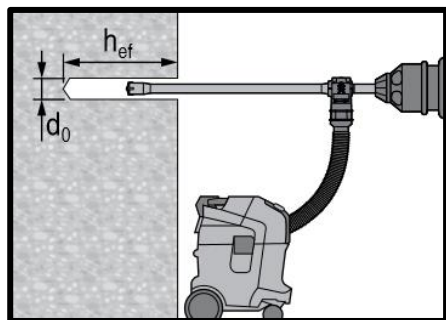

Hammer drilled hole with Hollow Drilled Bit (HDB)

No cleaning required.

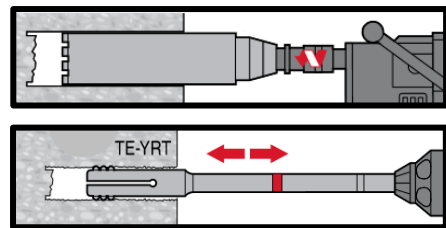

Diamond Drilling + Roughening Tool (DD+RT)

### Cleaning (Inadequate hole cleaning=poor load values.)

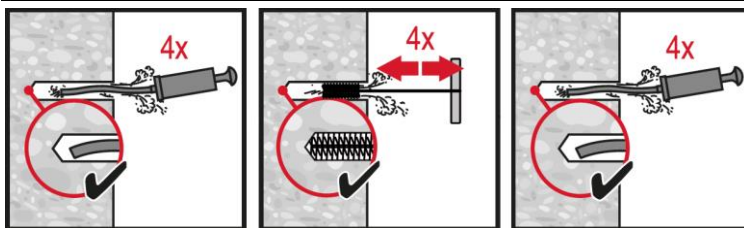

Hammer Drilling:

#### Manual cleaning (MC)

For drill diameters  $d_0 \leq 20$  mm and drill hole depth  $h_0 \leq 10 \cdot d$ .



Hammer Drilling:

#### Compressed air cleaning (CAC)

For  $\phi$  8 to  $\phi$  12 and drill hole depths  $\leq 250$  mm or  $\phi > 12$  mm and drill hole depths  $\leq 20 \cdot \phi$ .

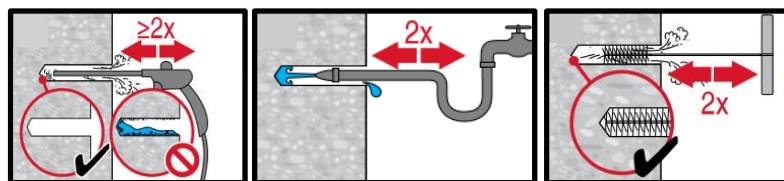

Diamond cored holes with Hilti roughening tool TE-YRT:

For all drill hole diameters  $d_0$  and drill hole depths.

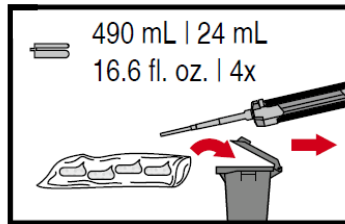
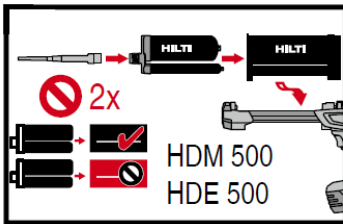
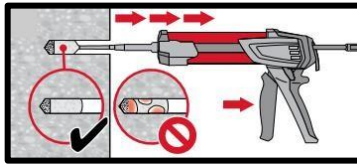
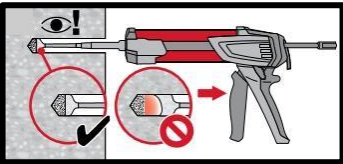
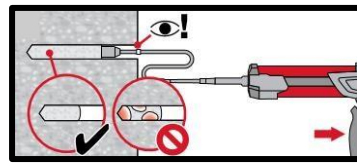
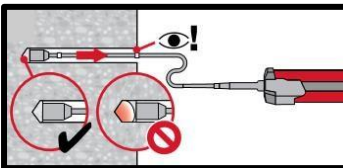
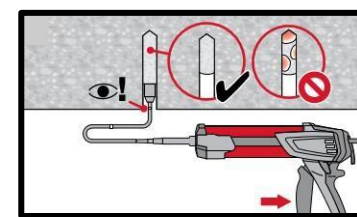
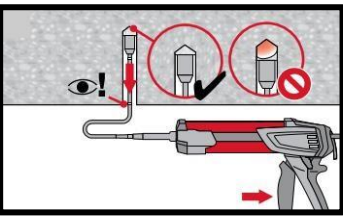
**Injection preparation**

**Injection system preparation.**

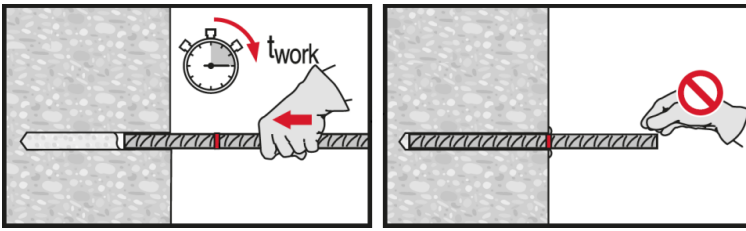
**Injection method for drill hole depth**  
 $h_{ef} \leq 250 \text{ mm.}$ 

**Injection method for drill hole depth**  
 $h_{ef} > 250 \text{ mm.}$ 

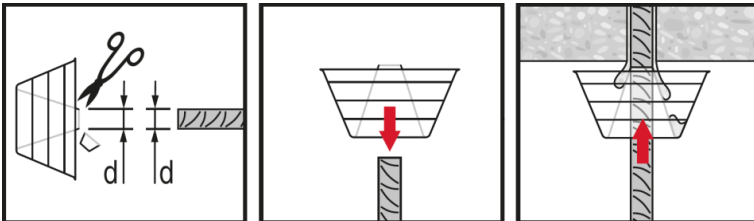
**Injection method for overhead**  
 application.

**Setting the element**



**Setting element**, observe working time “ $t_{work}$ ”.



**Setting element** for overhead applications, observe working time “ $t_{work}$ ”.

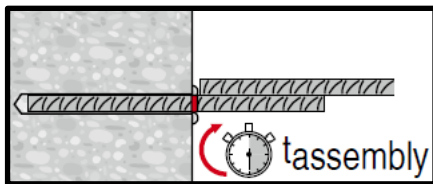
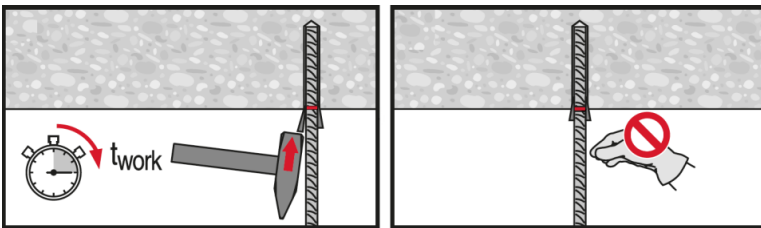

**Setting new rebars** or pouring new concrete only after assembly time “ $t_{assembly}$ ”

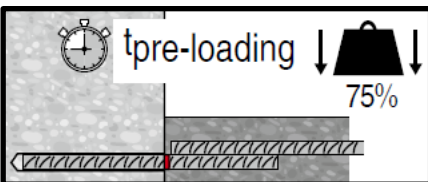

Apply 75% of full load only after curing time “ $t_{pre-loading}$ ”.

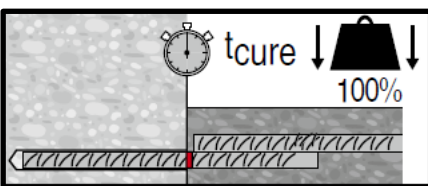

Apply full load only after curing time “ $t_{cure}$ ”.



## 2.1.6 HIT-RE 100

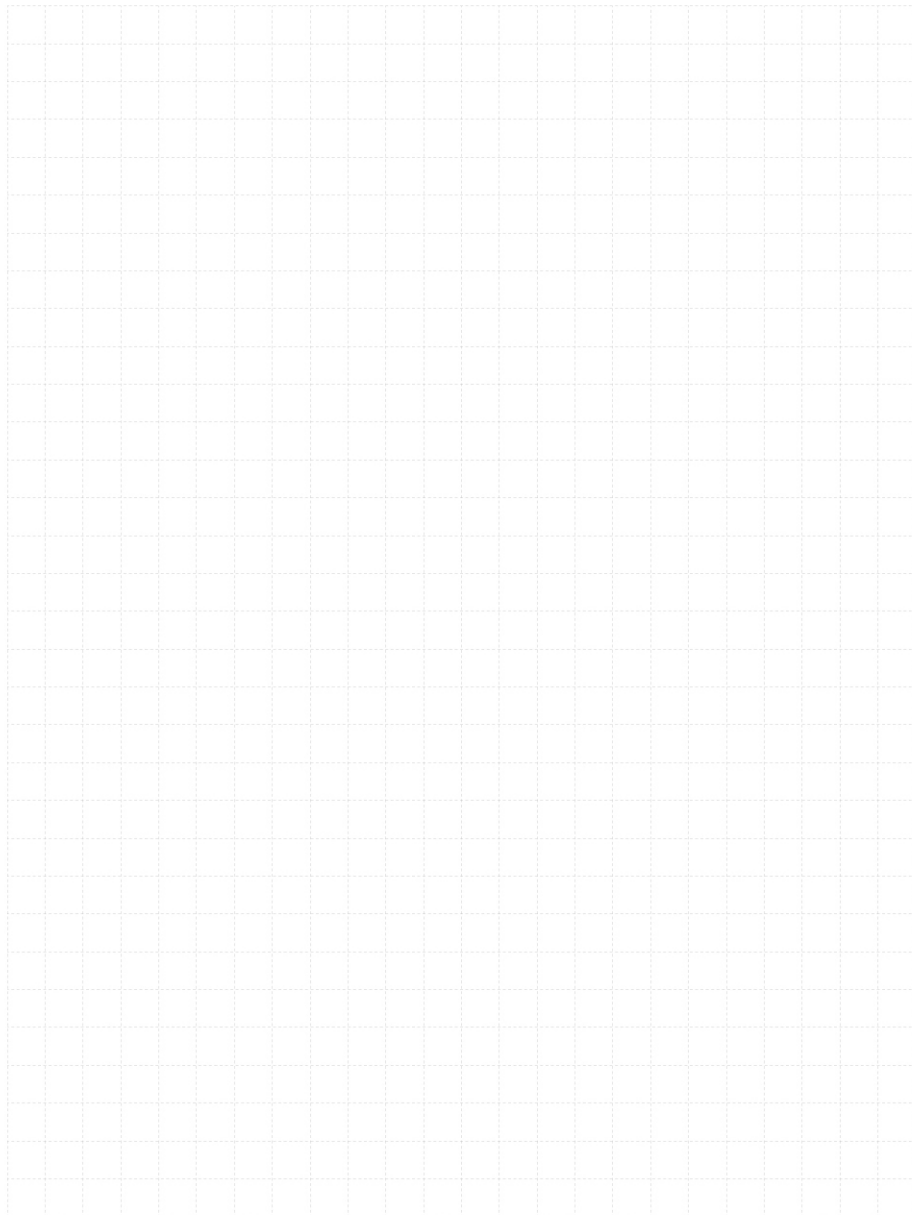

# HIT-RE 100 injection mortar

Anchor design (EN 1992-4) / Rods and Sleeves / Concrete

## Injection mortar system



Hilti HIT-RE 100  
500 ml foil pack  
(also available as  
330 ml foil pack)



Anchor rods:  
HAS-U  
HAS-U HDG  
HAS-U A4  
HAS-U HCR  
(M8-M30)

## Benefits

- Suitable for cracked and non-cracked concrete C 20/25 to C 50/60
- High loading capacity
- Suitable for dry and water saturated concrete
- Large diameter applications
- Long working time at elevated temperatures
- Odourless epoxy

## Base material



Concrete  
(non-cracked)



Concrete  
(cracked)

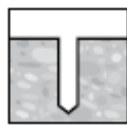

Dry concrete

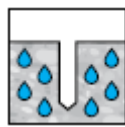

Wet  
concrete

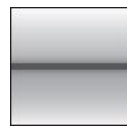

Static/  
quasi-static

## Load conditions

## Installation conditions



Hammer  
drilling



Variable  
embedment  
depth

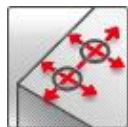

Small edge  
distance and  
spacing

## Other informations



European  
Technical  
Assessment



CE  
conformity

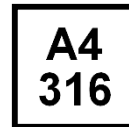

Corrosion  
resistance



High  
corrosion  
resistance

## Approvals / certificates

Description	Authority / Laboratory	No. / date of issue
European technical assessment <sup>a)</sup>	DIBt, Berlin	ETA-15/0882 / 2019-08-30

a) All data given in this section according to ETA-15/0882 issue 2017-12-11.

## Static and quasi-static loading (for a single anchor)

### All data in this section applies to

- Correct setting (See setting instruction)
- No edge distance and spacing influence
- Steel failure
- Base material thickness, as specified in the table
- Embedment depth, as specified in the table
- Anchor material, as specified in the tables
- Concrete C 20/25,  $f_{ck,cube} = 25 \text{ N/mm}^2$
- In-service temperature range I  
(min. base material temperature  $-40^\circ\text{C}$ , max. long term/short term base material temperature:  $+24^\circ\text{C}/40^\circ\text{C}$ )

### Embedment depth <sup>a)</sup> and base material thickness

Anchor size		M8	M10	M12	M16	M20	M24	M27	M30
Embedment depth	$h_{ef}$ [mm]	80	90	110	125	170	210	240	270
Base material thickness	$h$ [mm]	110	120	140	165	220	270	300	340

a) The allowed range of embedment depth is shown in the setting details

### Characteristic resistance

Anchor size		M8	M10	M12	M16	M20	M24	M27	M30	
<b>Non-cracked concrete</b>										
Tension	HAS-U 5.8	$N_{Rk}$ [kN]	18,3	29,0	42,2	68,8	109,0	149,7	182,9	218,2
	HAS-U 8.8		29,3	42,0	56,8	68,8	109,0	149,7	182,9	218,2
	HAS-U A4		25,6	40,6	56,8	68,8	109,0	149,7	182,9	218,2
	HAS-U HCR		29,3	42,0	56,8	68,8	109,0	149,7	182,9	218,2
Shear	HAS-U 5.8	$V_{Rk}$ [kN]	9,2	14,5	21,1	39,3	61,3	88,3	114,8	140,3
	HAS-U 8.8		14,6	23,2	33,7	62,8	98,0	141,2	183,6	224,4
	HAS-U A4		12,8	20,3	29,5	55,0	85,8	123,6	114,8	140,3
	HAS-U HCR		14,6	23,2	33,7	62,8	98,0	123,6	160,7	196,4
<b>Cracked concrete</b>										
Tension	HAS-U 5.8	$N_{Rk}$ [kN]	-	19,8	29,0	40,8	64,1	95,0	111,9	139,9
	HAS-U 8.8		-	19,8	29,0	40,8	64,1	95,0	111,9	139,9
	HAS-U A4		-	19,8	29,0	40,8	64,1	95,0	111,9	139,9
	HAS-U HCR		-	19,8	29,0	40,8	64,1	95,0	111,9	139,9
Shear	HAS-U 5.8	$V_{Rk}$ [kN]	-	14,5	21,1	39,3	61,3	88,3	114,8	140,3
	HAS-U 8.8		-	23,2	33,7	62,8	98,0	141,2	183,6	224,4
	HAS-U A4		-	20,3	29,5	55,0	85,8	123,6	114,8	140,3
	HAS-U HCR		-	23,2	33,7	62,8	98,0	123,6	160,7	196,4

**Design resistance**

Anchor size		M8	M10	M12	M16	M20	M24	M27	M30		
<b>Non-cracked concrete</b>											
Tension	HAS-U 5.8	N <sub>Rd</sub>	[kN]	12,2	19,3	27,0	32,7	51,9	71,3	87,1	103,9
	HAS-U 8.8			14,4	20,0	27,0	32,7	51,9	71,3	87,1	103,9
	HAS-U A4			13,7	20,0	27,0	32,7	51,9	71,3	80,2	98,1
	HAS-U HCR			14,4	20,0	27,0	32,7	51,9	71,3	87,1	103,9
Shear	HAS-U 5.8	V <sub>Rd</sub>	[kN]	7,3	11,6	16,9	31,4	49,0	70,6	91,8	112,2
	HAS-U 8.8			11,7	18,6	27,0	50,2	78,4	113,0	146,9	179,5
	HAS-U A4			8,2	13,0	18,9	35,2	55,0	79,2	48,2	58,9
	HAS-U HCR			11,7	18,6	27,0	50,2	78,4	70,6	91,8	112,2
<b>Cracked concrete</b>											
Tension	HAS-U 5.8	N <sub>Rd</sub>	[kN]	-	9,4	13,8	19,4	30,5	45,2	53,3	66,6
	HAS-U 8.8			-	9,4	13,8	19,4	30,5	45,2	53,3	66,6
	HAS-U A4			-	9,4	13,8	19,4	30,5	45,2	53,3	66,6
	HAS-U HCR			-	9,4	13,8	19,4	30,5	45,2	53,3	66,6
Shear	HAS-U 5.8	V <sub>Rd</sub>	[kN]	-	11,6	16,9	31,4	49,0	70,6	91,8	112,2
	HAS-U 8.8			-	18,6	27,0	50,2	78,4	113,0	146,9	179,5
	HAS-U A4			-	13,0	18,9	35,2	55,0	79,2	48,2	58,9
	HAS-U HCR			-	18,6	27,0	50,2	78,4	70,6	91,8	112,2

**Recommended loads <sup>a)</sup>**

Anchor size		M8	M10	M12	M16	M20	M24	M27	M30		
<b>Non-cracked concrete</b>											
Tension	HAS-U 5.8	N <sub>Rec</sub>	[kN]	8,7	13,8	19,3	23,4	37,1	50,9	62,2	74,2
	HAS-U 8.8			10,3	14,3	19,3	23,4	37,1	50,9	62,2	74,2
	HAS-U A4			9,8	14,3	19,3	23,4	37,1	50,9	57,3	70,1
	HAS-U HCR			10,3	14,3	19,3	23,4	37,1	50,9	62,2	74,2
Shear	HAS-U 5.8	V <sub>Rec</sub>	[kN]	5,2	8,3	12,0	22,4	35,0	50,4	65,6	80,1
	HAS-U 8.8			8,4	13,3	19,3	35,9	56,0	80,7	104,9	128,2
	HAS-U A4			5,9	9,3	13,5	25,2	39,3	56,6	34,4	42,1
	HAS-U HCR			8,4	13,3	19,3	35,9	56,0	50,4	65,6	80,1
<b>Cracked concrete</b>											
Tension	HAS-U 5.8	N <sub>Rec</sub>	[kN]	-	6,7	9,9	13,9	21,8	32,3	38,1	47,6
	HAS-U 8.8			-	6,7	9,9	13,9	21,8	32,3	38,1	47,6
	HAS-U A4			-	6,7	9,9	13,9	21,8	32,3	38,1	47,6
	HAS-U HCR			-	6,7	9,9	13,9	21,8	32,3	38,1	47,6
Shear	HAS-U 5.8	V <sub>Rec</sub>	[kN]	-	8,3	12,0	22,4	35,0	50,4	65,6	80,1
	HAS-U 8.8			-	13,3	19,3	35,9	56,0	80,7	104,9	128,2
	HAS-U A4			-	9,3	13,5	25,2	39,3	56,6	34,4	42,1
	HAS-U HCR			-	13,3	19,3	35,9	56,0	50,4	65,6	80,1

a) With overall partial safety factor for action  $\gamma=1,4$ . The partial safety factors for action depend on the type of loading and shall be taken from national regulations.

**Materials**
**Mechanical properties**

Anchor size				M8	M10	M12	M16	M20	M24	M27	M30
Nominal tensile strength	HAS-U 5.8	$f_{uk}$	[N/mm <sup>2</sup> ]	500	500	500	500	500	500	500	500
	HAS-U 8.8			800	800	800	800	800	800	800	800
	HAS-U A4			700	700	700	700	700	700	500	500
	HAS-U HCR			800	800	800	800	800	700	700	700
Yield strength	HAS-U 5.8	$f_{yk}$	[N/mm <sup>2</sup> ]	400	400	400	400	400	400	400	400
	HAS-U 8.8			640	640	640	640	640	640	640	640
	HAS-U A4			450	450	450	450	450	450	210	210
	HAS-U HCR			640	640	640	640	640	400	400	400
Stressed cross-section	HAS-U	$A_s$	[mm <sup>2</sup> ]	36,6	58,0	84,3	157	245	353	459	561
Moment of resistance	HAS-U	$W$	[mm <sup>3</sup> ]	31,2	62,3	109	277	541	935	1387	1874

**Material quality for HAS-U**

Part	Material
<b>Zinc coated steel</b>	
Threaded rod, HAS-U 5.8 (HDG)	Strength class 5.8; Elongation at fracture A5 > 8% ductile Electroplated zinc coated $\geq 5\mu\text{m}$ ; (HDG) hot dip galvanized $\geq 45\mu\text{m}$
Threaded rod, HAS-U 8.8 (HDG)	Strength class 8.8; Elongation at fracture A5 > 12% ductile Electroplated zinc coated $\geq 5\mu\text{m}$ ; (HDG) hot dip galvanized $\geq 45\mu\text{m}$
Washer	Electroplated zinc coated $\geq 5\mu\text{m}$ , hot dip galvanized $\geq 45\mu\text{m}$
Nut	Strength class of nut adapted to strength class of threaded rod. Electroplated zinc coated $\geq 5\mu\text{m}$ , hot dip galvanized $\geq 45\mu\text{m}$
<b>Stainless Steel</b>	
Threaded rod, HAS-U A4	Strength class 70 for $\leq M24$ and strength class 50 for $> M24$ ; Elongation at fracture A5 > 8% ductile Stainless steel 1.4401; 1.4404; 1.4578; 1.4571; 1.4439; 1.4362
Washer	Stainless steel 1.4401, 1.4404, 1.4578, 1.4571, 1.4439, 1.4362 EN 10088-1:2014
Nut	Stainless steel 1.4401, 1.4404, 1.4578, 1.4571, 1.4439, 1.4362 EN 10088-1:2014
<b>High corrosion resistant steel</b>	
Threaded rod, HAS-U HCR	Strength class 80 for $\leq M20$ and class 70 for $> M20$ , Elongation at fracture A5 > 8% ductile High corrosion resistance steel 1.4529; 1.4565;
Washer	High corrosion resistant steel 1.4529, 1.4565 EN 10088-1:2014
Nut	High corrosion resistant steel 1.4529, 1.4565 EN 10088-1:2014

## Setting information

### Installation temperature range:

+5°C to +40°C

### Service temperature range

Hilti HIT-RE 100 injection mortar may be applied in the temperature ranges given below. An elevated base material temperature may lead to a reduction of the design bond resistance.

Temperature range	Base material temperature	Maximum long term base material temperature	Maximum short term base material temperature
Temperature range I	-40 °C to + 40 °C	+ 24 °C	+ 40 °C
Temperature range II	-40 °C to + 58 °C	+ 35 °C	+ 58 °C
Temperature range III	-40 °C to + 70 °C	+ 43 °C	+ 70 °C

### Maximum short term base material temperature

Short term elevated base material temperatures are those that occur over brief intervals, e.g. as a result of diurnal cycling.

### Maximum long term base material temperature

Long term elevated base material temperatures are roughly constant over significant periods of time.

### Working time and curing time <sup>a)</sup>

Temperature of the base material	Maximum working time	Minimum curing time
$T_{BM}$	$t_{work}$	$t_{cure}^{a)}$
$5\text{ °C} \leq T_{BM} < 10\text{ °C}$	2 h	72 h
$10\text{ °C} \leq T_{BM} < 15\text{ °C}$	1,5 h	48 h
$15\text{ °C} \leq T_{BM} < 20\text{ °C}$	30 min	24 h
$20\text{ °C} \leq T_{BM} < 30\text{ °C}$	20 min	12 h
$30\text{ °C} \leq T_{BM} < 40\text{ °C}$	12 min	8 h
40 °C	12 min	4 h

a) The curing time data are valid for dry base material only. In wet base material the curing times must be doubled.

**Setting details**

Anchor size		M8	M10	M12	M16	M20	M24	M27	M30
Nominal diameter of drill bit	$d_0$ [mm]	10	12	14	18	22	28	30	35
Diameter of element	$d$ [mm]	8	10	12	16	20	24	27	30
Effective anchorage depth (=drill hole depth) <sup>a)</sup>	$h_{ef,min} = h_0$ [mm]	60	60	70	80	90	96	108	120
	$h_{ef,max} = h_0$ [mm]	160	200	240	320	400	480	540	600
Minimum base material thickness <sup>a)</sup>	$h_{min}$ [mm]	$h_{ef} + 30 \geq 100$ mm			$h_{ef} + 2 d_0$				
Maximum diameter of clearance hole in the fixture	$d_f$ [mm]	9	12	14	18	22	26	30	33
Minimum spacing	$s_{min}$ [mm]	40	50	60	80	100	120	135	150
Minimum edge distance	$c_{min}$ [mm]	40	50	60	80	100	120	135	150
Critical spacing for splitting failure	$s_{cr,sp}$ [mm]	$2 c_{cr,sp}$							
Critical edge distance for splitting failure	$c_{cr,sp}$ [mm]	$1,0 \cdot h_{ef}$		for $h / h_{ef} \geq 2,0$					
		$4,6 h_{ef} - 1,8 h$		for $2,0 > h / h_{ef} > 1,3$					
		$2,26 h_{ef}$		for $h / h_{ef} \leq 1,3$					
Critical spacing for concrete cone failure	$s_{cr,N}$ [mm]	$2 c_{cr,N}$							
Critical edge distance for concrete cone failure <sup>b)</sup>	$c_{cr,N}$ [mm]	$1,5 h_{ef}$							
Maximum torque moment <sup>c)</sup>	$T_{max}$ [Nm]	10	20	40	80	150	200	270	300

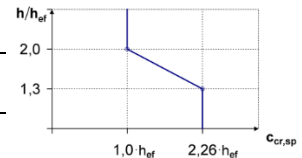

For spacing (edge distance) smaller than critical spacing (critical edge distance) the design loads have to be reduced.

- a)  $h_{ef,min} \leq h_{ef} \leq h_{ef,max}$  ( $h_{ef}$ : embedment depth)  $h$ : base material thickness ( $h \geq h_{min}$ )  
 b) The critical edge distance for concrete cone failure depends on the embedment depth  $h_{ef}$  and the design bond resistance. The simplified formula given in this table is on the safe side.  
 c) This is the maximum recommended torque moment to avoid splitting failure during installation for anchors with minimum spacing and/or edge distance.

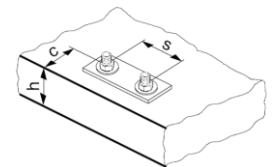
**Installation equipment**

Anchor size	M8	M10	M12	M16	M20	M24	M27	M30	
Rotary hammer	TE 2– TE 16				TE 40 – TE 80				
Other tools	Blow out pump ( $h_{ef} \leq 10 \cdot d$ , $d_0 \leq 20$ mm), compressed air gun, Set of cleaning brushes, dispenser, piston plug								

**Drilling and cleaning parameters**

HAS-U	Drilling and cleaning			Installation
	Hammer drill (HD)	Hollow Drill Bit (HDB)	Brush HIT-RB	Piston plug HIT-SZ
	$d_0$ [mm]		size [mm]	size [mm]
<b>M8</b>	10	-	10	-
<b>M10</b>	12	12	12	12
<b>M12</b>	14	14	14	14
<b>M16</b>	18	18	18	18
<b>M20</b>	22	22	22	22
<b>M24</b>	28	28	28	28
<b>M27</b>	30	-	30	30
<b>M30</b>	35	35	35	35

## Setting instructions

\*For detailed information on installation see instruction for use given with the package of the product.



### Safety regulations.

Review the Material Safety Data Sheet (MSDS) before use for proper and safe handling! Wear well-fitting protective goggles and protective gloves when working with Hilti HIT-RE 100.

### Drilling

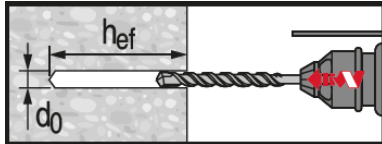

#### Hammer drilled hole

For dry and wet concrete.

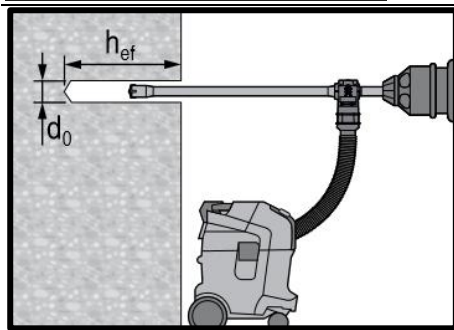

#### Hammer drilled hole with Hollow Drilled Bit (HDB)

No cleaning required.

### Cleaning

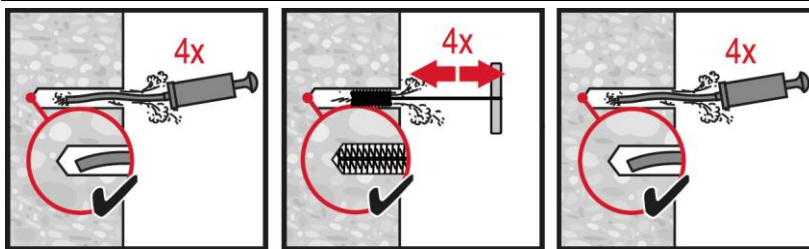

#### Manual cleaning (MC) Non-cracked concrete only

for drill diameters  $d_0 \leq 20$  mm and drill hole depth  $h_0 \leq 10 \cdot d$ .

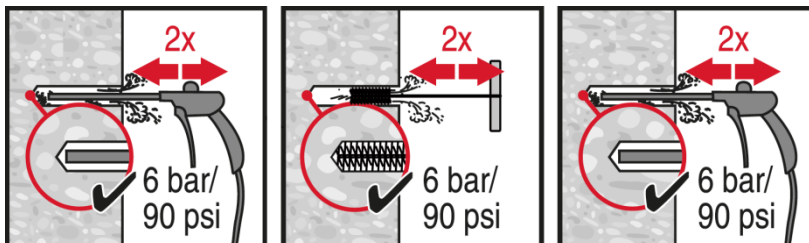

#### Compressed air cleaning (CAC)

for all drill hole diameters  $d_0$  and drill hole depths  $h_0 \leq 20 \cdot d$ .

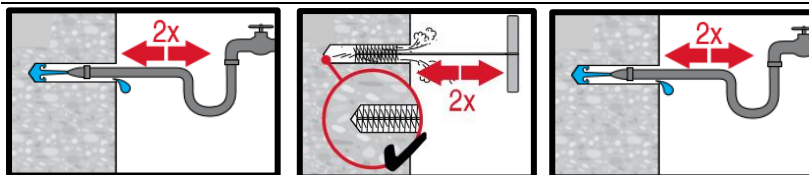

#### Compressed air cleaning (CAC) cleaning of flooded holes

for all drill hole diameters  $d_0$  and drill hole depths  $h_0$ .

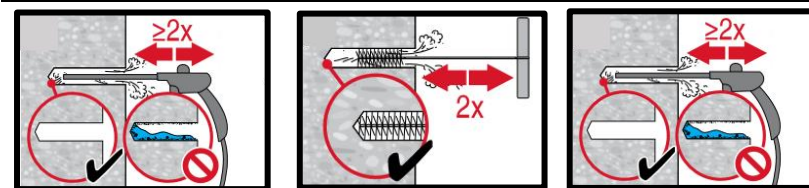



**Injection system**

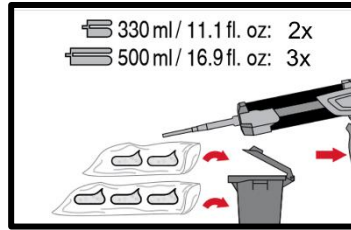
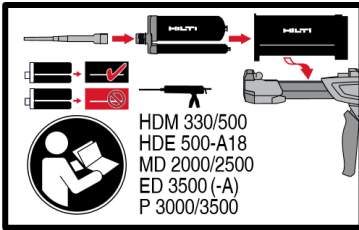

**Injection system preparation.**

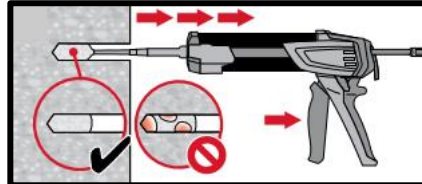
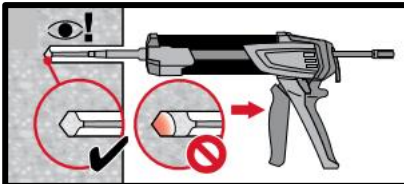

**Injection method for drill hole depth**  
 $h_{ef} \leq 250 \text{ mm.}$

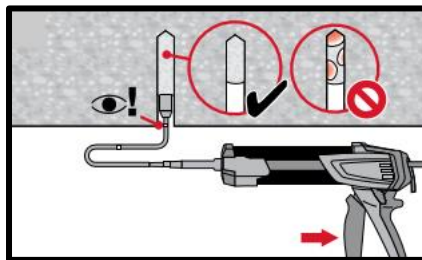
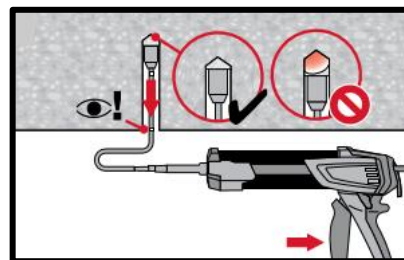

**Injection method for overhead**  
application and/or installation with  
embedment depth  $h_{ef} > 250 \text{ mm.}$

**Setting the element**

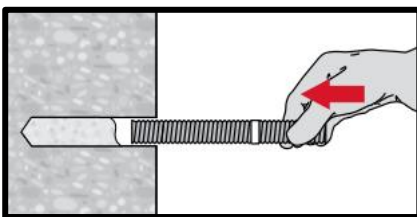

**Setting element**, observe working time  
“ $t_{work}$ ”,

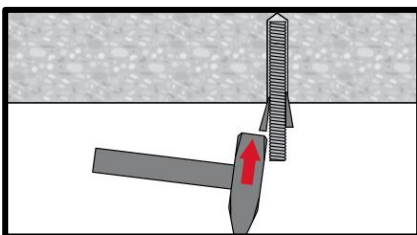

**Setting element** for overhead  
applications, observe working time “ $t_{work}$ ”,

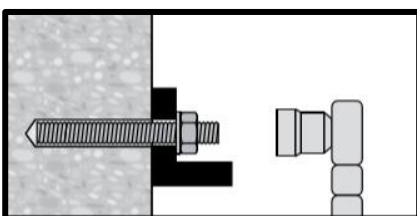

**Loading the anchor:** After required  
curing time  $t_{cure}$  the anchor can be  
loaded.

# HIT-RE 100 injection mortar

Anchor design (EN 1992-4) / Rebar elements / Concrete

## Injection mortar system



Hilti HIT-RE 100  
330 ml foil pack  
  
(also available as  
500 ml and 1400  
ml foil pack)

Rebar B500B  
( $\phi 8$ - $\phi 32$ )

## Benefits

- Suitable for cracked and non-cracked concrete C 20/25 to C 50/60
- High loading capacity
- Suitable for dry and water saturated concrete
- Large diameter applications
- Long working time at elevated temperatures
- Odourless epoxy

## Base material



Concrete  
(non-cracked)



Concrete  
(cracked)



Dry concrete

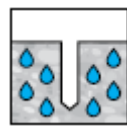

Wet  
concrete



Static/  
quasi-static

## Load conditions

## Installation conditions

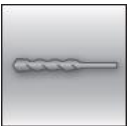

Hammer  
drilling

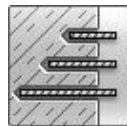

Variable  
embedment  
depth

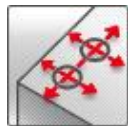

Small edge  
distance and  
spacing

## Other informations



European  
Technical  
Assessment



CE  
conformity

## Approvals / certificates

Description	Authority / Laboratory	No. / date of issue
European technical assessment <sup>a)</sup>	CSTB, Marne la Vallée	ETA-15/0882 / 2019-08-30

b) All data given in this section according to ETA-15/0882 issue 2019-08-30.

## Static and quasi-static loading (for a single anchor)

### All data in this section applies to

- Correct setting (See setting instruction)
- No edge distance and spacing influence
- Steel failure
- Base material thickness, as specified in the table
- Embedment depth, as specified in the table
- Anchor material, as specified in the tables
- Concrete C 20/25,  $f_{ck,cube} = 25 \text{ N/mm}^2$
- in-service temperate range I  
(min. base material temperature  $-40^\circ\text{C}$ , max. long term/short term base material temperature:  $+24^\circ\text{C}/40^\circ\text{C}$ )

### Embedment depth <sup>a)</sup> and base material thickness

Anchor size		φ8	φ10	φ12	φ14	φ16	φ20	φ25	φ26	φ28	φ30	φ32
Embedment depth	$h_{ef}$ [mm]	80	90	110	125	125	170	210	230	270	285	300
Base material thickness	$h$ [mm]	110	120	140	161	165	220	274	294	340	359	380

a) The allowed range of embedment depth is shown in setting details

### Characteristic resistance

Anchor size		φ8	φ10	φ12	φ14	φ16	φ20	φ25	φ26	φ28	φ30	φ32
<b>Non-cracked concrete</b>												
Tensile	Rebar B500B $N_{Rk}$ [kN]	28,0	39,6	56,8	65,9	68,8	109,0	149,7	171,6	218,2	236,7	255,6
Shear	Rebar B500B $V_{Rk}$ [kN]	14,0	22,0	31,0	42,0	55,0	86,0	135,0	146,0	169,0	194,0	221,0
<b>Cracked concrete</b>												
Tensile	Rebar B500B $N_{Rk}$ [kN]	-	19,8	29,0	35,7	40,8	64,1	98,9	103,3	130,6	147,7	165,8
Shear	Rebar B500B $V_{Rk}$ [kN]	-	22,0	31,0	42,0	55,0	86,0	135,0	146,0	169,0	194,0	221,0

### Design resistance

Anchor size		φ8	φ10	φ12	φ14	φ16	φ20	φ25	φ26	φ28	φ30	φ32
<b>Non-cracked concrete</b>												
Tensile	Rebar B500B $N_{Rd}$ [kN]	13,4	18,8	27,0	31,4	32,7	51,9	71,3	81,7	103,9	112,7	121,7
Shear	Rebar B500B $V_{Rd}$ [kN]	11,2	14,7	20,7	28,0	36,7	57,3	90,0	97,3	129,3	129,3	147,3
<b>Cracked concrete</b>												
Tensile	Rebar B500B $N_{Rd}$ [kN]	-	9,4	13,8	17,0	19,4	30,5	47,1	49,2	62,2	70,3	78,9
Shear	Rebar B500B $V_{Rd}$ [kN]	-	14,7	20,7	28,0	36,7	57,3	90,0	97,3	129,3	129,3	147,3

### Recommended loads <sup>a)</sup>

Anchor size		φ8	φ10	φ12	φ14	φ16	φ20	φ25	φ26	φ28	φ30	φ32
<b>Non-cracked concrete</b>												
Tensile	Rebar B500B $N_{Rec}$ [kN]	9,6	13,5	19,3	22,4	23,4	37,1	50,9	58,4	74,2	80,5	86,9
Shear	Rebar B500B $V_{Rec}$ [kN]	8,0	10,5	14,8	20,0	26,2	41,0	64,3	69,5	80,5	92,4	105,2
<b>Cracked concrete</b>												
Tensile	Rebar B500B $N_{Rec}$ [kN]	-	6,7	9,9	12,2	13,9	21,8	33,6	35,1	44,4	50,2	56,4
Shear	Rebar B500B $V_{Rec}$ [kN]	-	10,5	14,8	20,0	26,2	41,0	64,3	69,5	80,5	92,4	105,2

a) With overall partial safety factor for action  $\gamma=1,4$ . The partial safety factors for action depend on the type of loading and shall be taken from national regulations,

## Materials

### Mechanical properties

Anchor size		φ8	φ10	φ12	φ14	φ16	φ20	φ25	φ26	φ28	φ30	φ32
Nominal tensile strength	$f_{uk}$ [N/mm <sup>2</sup> ]	550	550	550	550	550	550	550	550	550	550	550
Yield strength	$f_{yk}$ [N/mm <sup>2</sup> ]	500	500	500	500	500	500	500	500	500	500	500
Stressed cross-section	$A_s$ [mm <sup>2</sup> ]	50,3	78,5	113,1	153,9	201,1	314,2	490,9	531	615,8	707	804,2
Moment of resistance	$W$ [mm <sup>3</sup> ]	50,3	98,2	169,6	269,4	402,1	785,4	1534	1726	2155	2651	3217

### Material quality

Part	Material
Rebar EN 1992-1-1:2004	Bars and de-coiled rods class B or C II according to NDP or NCL of EN 1992-1-1/NA:2013

## Setting information

### Installation temperature

+ 5°C to + 40°C

### Service temperature range

Hilti HIT-RE 100 injection mortar may be applied in the temperature ranges given below, An elevated base material temperature may lead to a reduction of the design bond resistance,

Temperature range	Base material temperature	Maximum long term base material temperature	Maximum short term base material temperature
Temperature range I	-40 °C to + 40 °C	+ 24 °C	+ 40 °C
Temperature range II	-40 °C to + 58 °C	+ 35 °C	+ 58 °C
Temperature range III	-40 °C to + 70 °C	+ 43 °C	+ 70 °C

### Maximum short term base material temperature

Short term elevated base material temperatures are those that occur over brief intervals, e.g, as a result of diurnal cycling,

### Maximum long term base material temperature

Long term elevated base material temperatures are roughly constant over significant periods of time,

### Working time and curing time <sup>a)</sup>

Temperature of the base material	Maximum working time	Minimum curing time
$T_{BM}$	$t_{work}$	$t_{cure}^a)$
$5\text{ °C} \leq T_{BM} < 10\text{ °C}$	2 h	72 h
$10\text{ °C} \leq T_{BM} < 15\text{ °C}$	1,5 h	48 h
$15\text{ °C} \leq T_{BM} < 20\text{ °C}$	30 min	24 h
$20\text{ °C} \leq T_{BM} < 30\text{ °C}$	20 min	12 h
$30\text{ °C} \leq T_{BM} < 40\text{ °C}$	12 min	8 h
40 °C	12 min	4 h

a) The curing time data are valid for dry base material only, In wet base material the curing times must be doubled,

**Setting details**

Anchor size		Ø8	Ø10	Ø12	Ø14	Ø16	Ø20	Ø25	Ø26	Ø28	Ø30	Ø32	
Nominal diameter of element	d [mm]	8	10	12	14	16	20	25	26	28	30	32	
Nominal diameter of drill bit	d <sub>0</sub> [mm]	10 / 12 <sup>a)</sup>	12 / 14 <sup>a)</sup>	14 <sup>a)</sup>	16 <sup>a)</sup>	18	20	24 / 25 <sup>a)</sup>	30 / 32 <sup>a)</sup>	32	35	37	40
Effective anchorage depth (= drill hole depth) <sup>b)</sup>	h <sub>ef,min</sub> = h <sub>0</sub> [mm]	60	60	70	70	75	80	90	100	104	112	120	128
	h <sub>ef,max</sub> = h <sub>0</sub> [mm]	160	200	240	240	280	320	400	500	520	560	600	640
Minimum base material thickness	h <sub>min</sub> [mm]	h <sub>ef</sub> + 30 mm ≥ 100 mm				h <sub>ef</sub> + 2 d <sub>0</sub>							
Minimum spacing	s <sub>min</sub> [mm]	40	50	60	60	70	80	100	125	130	140	150	160
Minimum edge distance	c <sub>min</sub> [mm]	40	50	60	60	70	80	100	125	130	140	150	160
Critical spacing for splitting failure	s <sub>cr,sp</sub> [mm]	2 C <sub>cr,sp</sub>											
Critical edge distance for splitting failure <sup>c)</sup>	c <sub>cr,sp</sub> [mm]	1,0 · h <sub>ef</sub>		for h / h <sub>ef</sub> ≥ 2,0									
		4,6 h <sub>ef</sub> - 1,8 h		for 2,0 > h / h <sub>ef</sub> > 1,3									
		2,26 h <sub>ef</sub>		for h / h <sub>ef</sub> ≤ 1,3									
Critical spacing for concrete cone failure	s <sub>cr,N</sub> [mm]	2 C <sub>cr,N</sub>											
Critical edge distance for concrete cone failure <sup>d)</sup>	c <sub>cr,N</sub> [mm]	1,5 h <sub>ef</sub>											

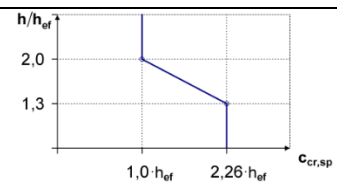

For spacing (edge distance) smaller than critical spacing (critical edge distance) the design loads have to be reduced,

- a) Both given values for drill bit diameter can be used  
 b)  $h_{ef,min} \leq h_{ef} \leq h_{ef,max}$  ( $h_{ef}$ : embedment depth)  
 c) h: base material thickness ( $h \geq h_{min}$ )  
 d) The critical edge distance for concrete cone failure depends on the embedment depth  $h_{ef}$  and the design bond resistance, The simplified formula given in this table is on the same side,

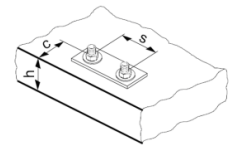
**Installation equipment**

Anchor size	φ8	φ10	φ12	φ14	φ16	φ20	φ25	φ26	φ28	φ30	φ32	
Rotary hammer	TE 2– TE 16						TE 40 – TE 80					
Other tools	Blow out pump ( $h_{ef} \leq 10 \cdot d$ , $d_0 \leq 20$ mm), compressed air gun, Set of cleaning brushes, dispenser, piston plug											

**Drilling and cleaning parameters**

Rebar [mm]	Drilling and cleaning			Installation
	Hammer drill (HD)	Hollow Drill Bit (HDB)	Brush HIT-RB	Piston plug HIT-SZ
	diameter d <sub>0</sub> [mm]			size [mm]
φ8	10 / 12 <sup>a)</sup>	12 <sup>a)</sup>	10 / 12 <sup>a)</sup>	- / 12 <sup>a)</sup>
φ10	12 / 14 <sup>a)</sup>	12 / 14 <sup>a)</sup>	12 / 14 <sup>a)</sup>	12 / 14 <sup>a)</sup>
φ12	14 / 16 <sup>a)</sup>	14 / 16 <sup>a)</sup>	14 / 16 <sup>a)</sup>	14 / 16 <sup>a)</sup>
φ14	18	18	18	18
φ16	20	20	20	20
φ20	24 / 25 <sup>a)</sup>	24 / 25 <sup>a)</sup>	24 / 25 <sup>a)</sup>	24 / 25 <sup>a)</sup>
φ25	30 / 32 <sup>a)</sup>	32 <sup>a)</sup>	30 / 32 <sup>a)</sup>	30 / 32 <sup>a)</sup>
φ26	32	32	32	32
φ28	35	-	35	35
φ30	37	-	37	37
φ32	40	-	40	40

- a) Both of the two given values can be used

## Setting instructions

\*For detailed information on installation see instruction for use given with the package of the product,



### Safety regulations,

Review the Material Safety Data Sheet (MSDS) before use for proper and safe handling! Wear well-fitting protective goggles and protective gloves when working with Hilti HIT-RE 100

## Drilling

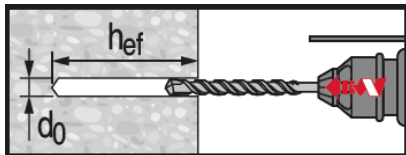

### Hammer drilled hole

For dry and wet concrete,

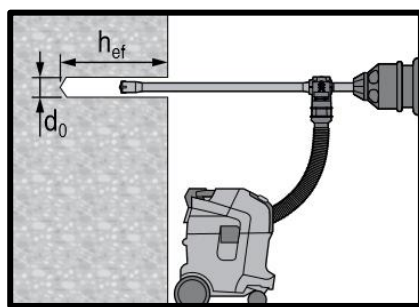

### Hammer drilled hole with Hollow Drilled Bit (HDB)

No cleaning required,

## Cleaning

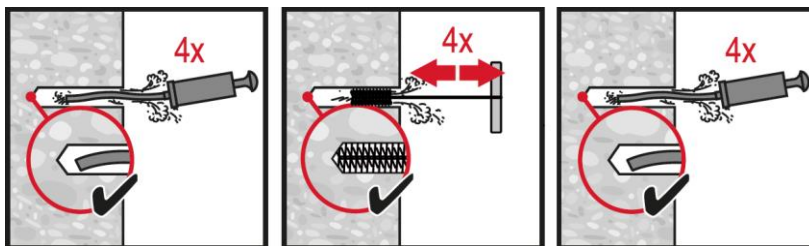

### Manual cleaning (MC) Non-cracked concrete only

for drill diameters  $d_0 \leq 20$  mm and drill hole depths  $h_0 \leq 10 \cdot d$ ,

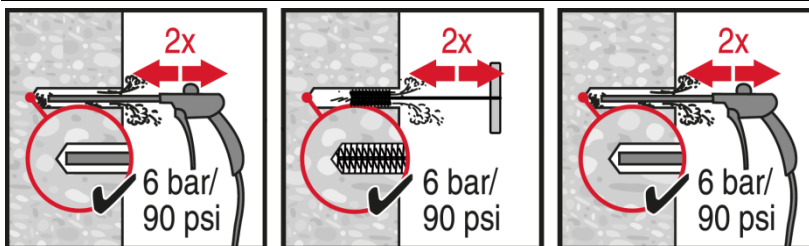

### Hammer Drilling:

### Compressed air cleaning (CAC)

for all drill hole diameters  $d_0$  and drill hole depths  $h_0 \leq 20 \cdot d$ ,

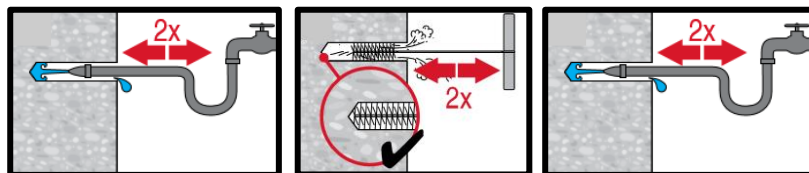

### Compressed air cleaning (CAC) cleaning of flooded holes

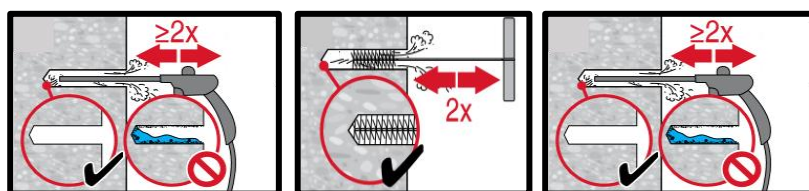

for all drill hole diameters  $d_0$  and drill hole depths  $h_0$ ,



**Injection system**

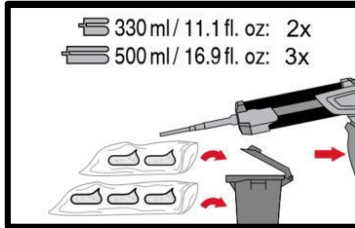
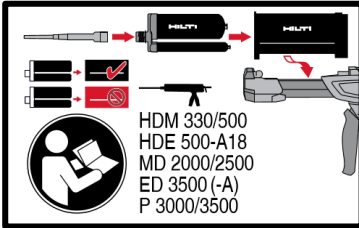

**Injection system preparation,**

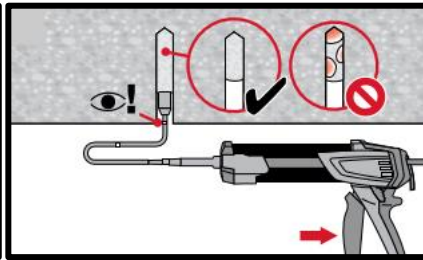
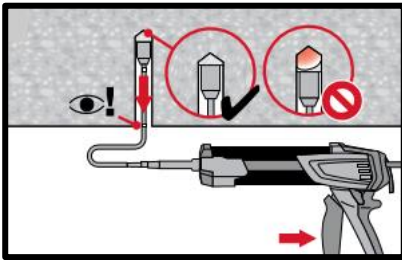

**Injection method for overhead application and/or installation with embedment depth  $h_{ef} \leq 250$  mm**

**Setting the element**

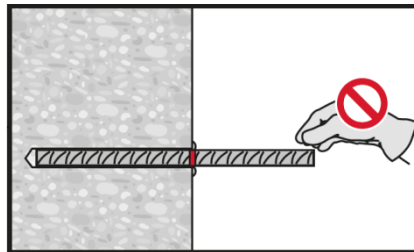
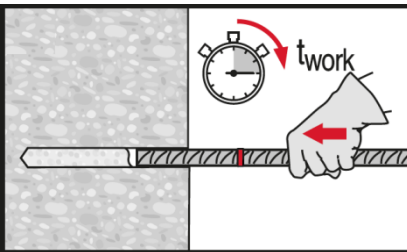

**Setting element, observe working time "t<sub>work</sub>",**

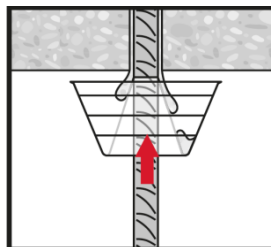
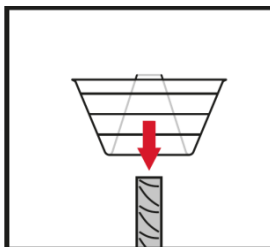
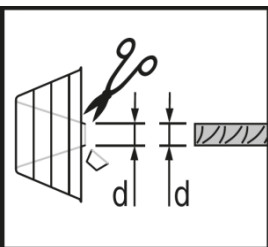



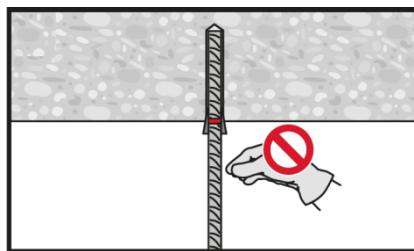
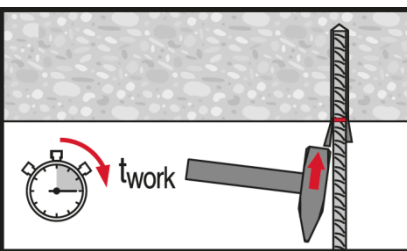







**Setting element for overhead applications, observe working time "t<sub>work</sub>",**

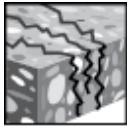

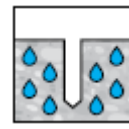
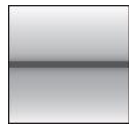
# HIT-RE 100 injection mortar

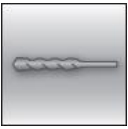
Rebar design (EN 1992-1) / Rebar elements / Concrete

Injection mortar system	Benefits
 <p>Hilti HIT-RE 100 330 ml foil pack (also available as 500 ml and 1400 ml foil pack)</p> <p>Rebar B500 B (<math>\phi 8 - \phi 40</math>)</p>	<ul style="list-style-type: none"> <li>- Suitable for concrete C 12/15 to C 50/60</li> <li>- High loading capacity</li> <li>- Suitable for dry and water saturated concrete</li> <li>- For rebar diameters up to 40 mm</li> <li>- Non corrosive to rebar elements</li> <li>- Long working time at elevated temperatures</li> <li>- Suitable for embedment length till 3200 mm</li> </ul>

Base material	Load conditions
 Concrete (non-cracked)  Concrete (cracked)  Dry concrete  Wet concrete	 Static/ quasi-static  Fire resistance
Installation conditions	Other information
 Hammer drilling  Diamond coring	 European Technical Assessment  CE conformity

## Approvals / certificates

Description	Authority / Laboratory	No, / date of issue
European technical assessment <sup>a)</sup>	DIBt, Berlin	ETA – 15/0883 / 2017-12-06
Fire report	MFPA, Leipzig	GS 3,2/15-431-4 / 2016-04-29

c) All data given in this section according to the approvals mentioned above ETA-15/0883 issue 2017-12-06,



**Basic design data**
**Static EC2 design**
**Design bond strength in N/mm<sup>2</sup> according to ETA 15/0883 for good bond conditions**

Rebar-size	Concrete class								
	C12/15	C16/20	C20/25	C25/30	C30/37	C35/45	C40/50	C45/55	C50/60
<b>All allowed hammer drilling methods</b>									
φ8 - φ32	1,6	2,0	2,3	2,7	3,0	3,4	3,7	4,0	4,3
φ34	1,6	2,0	2,3	2,6	2,9	3,3	3,6	3,9	4,2
φ36	1,5	1,9	2,2	2,6	2,9	3,3	3,6	3,8	4,1
φ40	1,5	1,8	2,1	2,5	2,8	3,1	3,4	3,7	4,0
<b>Diamond coring wet</b>									
φ8 - φ32	1,6	2,0	2,3	2,7					
φ34	1,6	2,0	2,3	2,6					
φ36	1,5	1,9	2,2	2,6					
φ40	1,5	1,8	2,1	2,5					

For poor bond conditions multiply the values by 0,7, Values valid for non-cracked and cracked concrete

**Minimum anchorage length and minimum lap length**

The minimum anchorage length  $\ell_{b,min}$  and the minimum overlap length  $\ell_{0,min}$  according to EN 1992-1-1 shall be multiplied by the relevant **Amplification factor** in the table below,

**Amplification factor  $\alpha_{lb}$  for the min, anchorage length and min, lap length according to EN 1992-1-1 for:**

Rebar - size	Concrete class								
	C12/15	C16/20	C20/25	C25/30	C30/37	C35/45	C40/50	C45/55	C50/60
<b>All allowed hammer drilling methods</b>									
φ8 - φ40	1,0								
<b>Diamond coring dry and wet</b>									
φ8 - φ40	1,5								

**Pre-calculated values<sup>1)</sup> – anchorage length**

Rebar yield strength  $f_{yk}=500$  N/mm<sup>2</sup>, concrete C25/30, good bond conditions

Rebar-size	Anchorage length	Design value	Mortar volume <sup>2)</sup>	Anchorage length	Design value	Mortar volume <sup>2)</sup>	
	$\ell_{bd}$ [mm]	$N_{Rd}$ [KN]	$V_M$ [ml]		$\ell_{bd}$ [mm]	$N_{Rd}$ [KN]	$V_M$ [ml]
$\alpha_1=\alpha_2=\alpha_3=\alpha_4=\alpha_5=1,0$							
φ8	100	6,8	8	100	9,7	8	
	170	11,5	13		140	13,6	11
	250	17,0	19		180	17,4	14
	<b>322,1</b>	21,9	24		<b>225,4</b>	21,9	17
φ10	121	10,3	11	121	14,7	11	
	220	18,7	20	170	20,6	15	
	310	26,3	28	230	27,9	21	
	<b>402,6</b>	34,1	36	<b>281,8</b>	34,1	25	
φ12	145	14,8	15	145	21,1	15	
	260	26,5	27	210	30,5	22	
	370	37,7	39	270	39,3	29	
	<b>483,1</b>	49,2	51	<b>338,2</b>	49,2	36	
φ14	169	20,1	20	169	28,7	20	
	300	35,6	36	240	40,7	29	
	430	51,1	52	320	54,3	39	
	<b>563,6</b>	66,9	68	<b>394,5</b>	66,9	48	

**Pre-calculated values<sup>1)</sup> – anchorage length**

 Rebar yield strength  $f_{yk}=500$  N/mm<sup>2</sup>, concrete C25/30, good bond conditions

Rebar-size	Anchorage length	Design value	Mortar volume <sup>2)</sup>	Anchorage length	Design value	Mortar volume <sup>2)</sup>
	$l_{bd}$ [mm]	$N_{Rd}$ [KN]	$V_M$ [ml]		$l_{bd}$ [mm]	$N_{Rd}$ [KN]
	$\alpha_1=\alpha_2=\alpha_3=\alpha_4=\alpha_5=1,0$				$\alpha_1=\alpha_3=\alpha_4=1,0 \quad \alpha_2 \text{ or } \alpha_5=0,7$	
φ16	193	26,2	26	193	37,4	26
	340	46,1	46	280	54,3	38
	490	66,5	67	370	71,7	50
	<b>644</b>	87,4	87	<b>450,9</b>	87,4	61
φ18	217	33,1	33	217	47,3	33
	380	58	57	310	67,6	47
	540	82,4	81	410	89,4	62
	<b>724,6</b>	110,6	109	<b>507,2</b>	110,6	76
φ20	242	41,1	51	242	58,6	51
	390	66,2	83	350	84,8	74
	550	93,3	117	460	111,5	98
	<b>805,2</b>	136,6	171	<b>563,6</b>	136,6	120
φ22	266	49,6	75	266	70,9	75
	410	76,5	116	380	101,3	107
	560	104,5	158	500	133,3	141
	<b>885,7</b>	165,3	250	<b>620</b>	165,3	175
φ24	290	59	122	290	84,3	122
	430	87,5	182	420	122,1	177
	560	114	236	550	160	232
	<b>966,2</b>	196,7	408	<b>676,3</b>	196,7	286
φ25	302	64	114	302	91,5	114
	430	91,2	162	430	130,3	162
	570	120,9	214	570	172,7	214
	<b>1006,4</b>	213,4	378	<b>704,5</b>	213,4	265
φ28	350	83,1	145	338	114,7	140
	595	141,3	247	480	162,9	200
	875	207,8	364	635	215,5	264
	<b>1127,2</b>	267,7	469	<b>789</b>	267,7	328
φ30	374	95,2	165	374	136	165
	635	161,6	281	528	191,9	233
	935	237,9	413	700	254,5	309
	<b>1207,7</b>	307,3	534	<b>845,4</b>	307,3	374
φ32	400	108,6	217	400	155,1	217
	680	184,6	369	580	224,9	315
	1000	271,4	543	800	310,2	434
	<b>1288,2</b>	349,7	699	<b>901,8</b>	349,7	490
φ36	450	132,3	387	440	184,8	379
	765	225	658	640	268,8	551
	1125	330,8	968	900	378,1	774
	<b>1505,0</b>	442,6	1295	<b>1053,5</b>	442,6	907
φ40	500	157,1	520	485	217,7	505
	850	267	884	700	314,2	728
	1000	314,2	1040	990	444,3	1030
	<b>1739,1</b>	546,4	1810	<b>1217,4</b>	546,4	1267

1) Values corresponding to the minimum anchorage length. The maximum permissible load is valid for "good bond conditions" as described in EN 1992-1-1. For all other conditions multiply by the value by 0,7,

 2) The volume of mortar corresponds to the formula " $1,2 \cdot (d_o^2 - d_s^2) \cdot \pi \cdot l_{bd} / 4$ " for hammer drilling

**Pre-calculated values – overlap length**

 Rebar yield strength  $f_{yk}=500 \text{ N/mm}^2$ , concrete c25/30, good bond conditions

Rebar-size	Overlap length	Design value	Mortar volume <sup>2)</sup>	Overlap length	Design value	Mortar volume <sup>2)</sup>
	$l_0$ [mm]	$N_{Rd}$ [KN]	$V_M$ [ml]		$l_0$ [mm]	$N_{Rd}$ [KN]
$\alpha_1=\alpha_2=\alpha_3=\alpha_4=\alpha_5=1,0$				$\alpha_1=\alpha_3=\alpha_4=1,0 \quad \alpha_2 \text{ or } \alpha_5=0,7$		
$\phi 8$	200	13,6	15	200	19,4	15
	240	16,3	18	210	20,4	16
	280	19	21	220	21,3	17
	<b>322,1</b>	21,9	24	<b>225,4</b>	21,9	17
$\phi 10$	200	17	18	200	24,2	18
	270	22,9	24	230	27,9	21
	340	28,8	31	250	30,3	23
	<b>402,6</b>	34,1	36	<b>281,8</b>	34,1	25
$\phi 12$	200	20,4	21	200	29,1	21
	290	29,5	31	250	36,4	26
	390	39,7	41	290	42,2	31
	<b>483,1</b>	49,2	51	<b>338,2</b>	49,2	36
$\phi 14$	210	24,9	25	210	35,6	25
	330	39,2	40	270	45,8	33
	450	53,4	54	330	56	40
	<b>563,6</b>	66,9	68	<b>394,5</b>	66,9	48
$\phi 16$	240	32,6	33	240	46,5	33
	370	50,2	50	310	60,1	42
	510	69,2	69	380	73,7	52
	<b>644</b>	87,4	87	<b>450,9</b>	87,4	61
$\phi 18$	270	41,2	41	270	58,9	41
	410	62,6	62	350	76,3	53
	560	85,5	84	430	93,8	65
	<b>724,6</b>	110,6	109	<b>507,2</b>	110,6	76
$\phi 20$	300	50,9	64	300	72,7	64
	430	72,9	91	390	94,5	83
	570	96,7	121	480	116,3	102
	<b>805,2</b>	136,6	171	<b>563,6</b>	136,6	120
$\phi 22$	330	61,6	93	330	88	93
	450	84	127	430	114,6	122
	580	108,2	164	520	138,6	147
	<b>885,7</b>	165,3	250	<b>620</b>	165,3	175
$\phi 24$	360	73,3	152	360	104,7	152
	470	95,7	198	470	136,7	198
	590	120,1	249	570	165,8	241
	<b>966,2</b>	196,7	408	<b>676,3</b>	196,7	286
$\phi 25$	375	79,5	141	375	113,6	141
	430	91,2	162	480	145,4	181
	570	120,9	214	590	178,7	222
	<b>1006,4</b>	213,4	378	<b>704,5</b>	213,4	265
$\phi 28$	420	99,8	175	420	142,5	175
	595	141,3	247	530	179,8	220
	875	207,8	364	635	215,5	264
	<b>1127,2</b>	267,7	469	<b>789</b>	267,7	328

### Pre-calculated values – overlap length

Rebar yield strength  $f_{yk}=500 \text{ N/mm}^2$ , concrete c25/30, good bond conditions

Rebar-size	Overlap length	Design value	Mortar volume <sup>2)</sup>	Overlap length	Design value	Mortar volume <sup>2)</sup>
	$l_0$ [mm]	$N_{Rd}$ [KN]	$V_M$ [ml]		$l_0$ [mm]	$N_{Rd}$ [KN]
	$\alpha_1=\alpha_2=\alpha_3=\alpha_4=\alpha_5=1,0$			$\alpha_1=\alpha_3=\alpha_4=1,0 \quad \alpha_2 \text{ or } \alpha_5=0,7$		
$\phi 30$	450	114,5	199	450	163,6	199
	635	161,6	281	528	191,9	233
	935	237,9	413	700	254,5	309
	<b>1207,7</b>	<b>307,3</b>	<b>534</b>	<b>845,4</b>	<b>307,3</b>	<b>374</b>
$\phi 32$	480	130,3	261	480	186,1	261
	680	184,6	369	650	252	353
	1000	271,4	543	800	310,2	434
	<b>1288,2</b>	<b>349,7</b>	<b>699</b>	<b>901,8</b>	<b>349,7</b>	<b>490</b>
$\phi 36$	540	158,8	465	540	218,1	465
	765	225,0	658	720	290,0	620
	1125	330,8	968	900	363,5	774
	<b>1505,0</b>	<b>442,6</b>	<b>1295</b>	<b>1053,5</b>	<b>442,6</b>	<b>907</b>
$\phi 40$	600	188,5	624	600	269,3	624
	850	267,0	884	750	336,6	780
	1000	314,2	1040	990	444,3	1030
	<b>1739,1</b>	<b>505,9</b>	<b>1676</b>	<b>1217,4</b>	<b>546,4</b>	<b>1267</b>

- 1) Values corresponding to the minimum anchorage length, The maximum permissible load is valid for "good bond conditions" as described in EN 1992-1-1, For all other conditions multiply by the value by 0,7,
- 2) The volume of mortar corresponds to the formula " $1,2 \cdot (d_0^2 - d_s^2) \cdot \pi \cdot l_b / 4$ " for hammer drilling

### Fire resistance

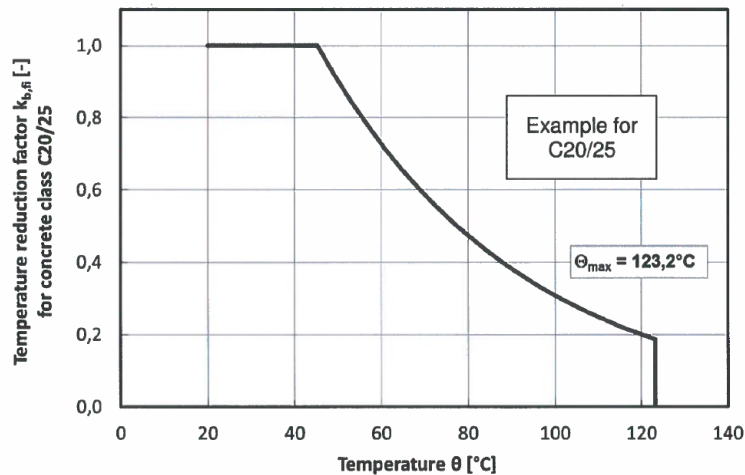

The design value of the bond strength  $f_{bd,fi}$  under fire exposure has to be calculated by the following equation:

$$f_{bd,fi} = k_{b,fi}(\theta) \cdot f_{bd} \cdot \gamma_c / \gamma_{M,fi}$$

With:  $\theta \leq 123,2^\circ\text{C}$ :  $k_{b,fi}(\theta) = 26,424 \cdot e^{-0,0215 \cdot \theta} / f_{bd} \cdot 4,3 \leq 1,0$   
 $\theta > 123,2^\circ\text{C}$ :  $k_{b,fi}(\theta) = 0,0$

$f_{bd,fi}$  design value of the ultimate bond stress in case of fire in  $\text{N/mm}^2$   
 $\theta$  temperature in  $^\circ\text{C}$  in the mortar layer  
 $k_{b,fi}(\theta)$  reduction factor under fire exposure  
 $f_{bd}$  design values of the ultimate bond stress in  $\text{N/mm}^2$  in cold condition  
 $\gamma_c$  partially safety factor according to EN 1992-1-1  
 $\gamma_{M,fi}$  partially safety factor according to EN 1992-1-2

## a) Anchoring application

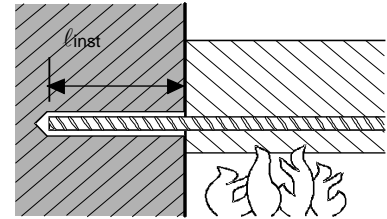

## Anchoring application beam-wall connections with a concrete cover of 20 mm

Maximum force ( $F_{s,T,max}$ ) in rebar in conjunction with HIT-RE 100 as a function of embedment depth ( $l_{inst}$ ) for the fire resistance classes R30 to R240 according to EC2,

Rebar-size	$F_{s,T,max}$ [kN]	$l_{inst}$ [mm]	Fire resistance of bar [kN]						
			R30	R60	R90	R120	R180	R240	
$\phi 8$	16,8	100	3,4	1,0	0,2	-	-	-	
		110	4,3	1,7	0,5	-	-	-	
		140	6,9	4,2	2,2	0,9	-	-	
		160	8,6	6,0	3,9	2,1	0,5	-	
		260	16,8	16,8	14,6	12,5	10,7	7,7	5,3
		290			15,1	13,3	10,3	7,9	
		310			15,1	12,1	9,6		
		330			16,8	13,8	11,4		
		370			16,8	14,8			
		400			16,8				
$\phi 10$	26,2	110	5,3	2,1	0,6	-	-	-	
		140	8,6	5,3	2,7	1,2	-	-	
		160	10,8	7,4	4,8	2,7	0,6	-	
		260	21,6	18,3	15,7	13,4	9,7	6,6	
		290	24,8	21,5	18,9	16,7	12,9	9,9	
		310	26,2	26,2	23,7	21,1	18,8	15,1	12,0
		340			24,3	22,1	18,3	15,3	
		360			24,2	20,5	17,5		
		380			26,2	22,7	19,6		
		450			26,2	26,2			
$\phi 12$	37,7	130	9,0	5,0	2,2	0,8	-	-	
		140	10,3	6,3	3,2	1,4	-	-	
		160	12,9	8,9	5,8	3,2	0,8	-	
		260	25,9	21,9	18,8	16,1	11,6	7,9	
		360	37,7	37,7	35,0	31,8	29,1	24,6	20,9
		390			35,7	33,0	28,5	24,8	
		450			37,7	37,7	36,3	32,6	
		500			37,7	37,7	37,7	37,7	
$\phi 14$	51,3	160	15,1	10,4	6,8	3,7	0,9	-	
		260	30,2	25,6	21,9	18,8	13,5	9,3	
		360	45,4	40,8	37,1	33,9	28,7	24,4	
		400	51,3	51,3	46,8	43,2	40,0	34,8	30,5
		450			50,8	47,6	42,4	38,1	
		500			51,3	51,3	50,0	45,7	
		550			51,3	51,3	51,3	51,3	

Maximum force ( $F_{s,T,max}$ ) in rebar in conjunction with HIT-RE 100 as a function of embedment depth ( $l_{inst}$ ) for the fire resistance classes R30 to R240 according to EC2,

Rebar-size	$F_{s,T,max}$ [kN]	$l_{inst}$ [mm]	Fire resistance of bar [kN]						
			R30	R60	R90	R120	R180	R240	
φ16	67,0	180	20,7	15,4	11,2	7,6	2,7	0,9	
		260	34,5	29,3	25,1	21,5	15,5	10,6	
		360	51,9	46,6	42,4	38,8	32,8	27,9	
		450	67,0	67,0	62,2	58,0	54,4	48,4	43,5
		500			66,7	63,1	57,1	52,2	
		550			67,0	67,0	65,8	60,9	
		600			67,0	67,0	67,0	67,0	
67,0	67,0				67,0	67,0			
φ18	84,8	200	27,2	21,2	16,5	12,4	5,9	2,6	
		260	38,9	32,9	28,2	24,1	17,4	11,9	
		360	58,4	52,4	47,7	43,6	36,9	31,4	
		500	84,8	84,8	79,7	75,0	71,0	64,2	58,7
		550			80,7	74,0	68,5		
		600			84,8	84,8	84,8	83,8	78,2
					84,8	84,8	84,8	84,8	84,8
650	84,8	84,8			84,8	84,8	84,8		
φ20	104,7	220	34,5	27,9	22,7	18,2	10,7	5,5	
		260	43,2	36,6	31,3	26,8	19,4	13,2	
		360	64,9	58,3	53,0	48,5	41,0	34,9	
		550	104,7	104,7	99,4	94,2	89,7	82,2	76,1
		600			104,7	100,5	93,1	86,9	
		650			104,7	104,7	104,7	103,9	97,8
					104,7	104,7	104,7	104,7	104,7
700	104,7	104,7			104,7	104,7	104,7		
φ22	126,7	240	42,7	35,5	29,7	24,7	16,5	9,9	
		360	71,3	64,1	58,3	53,3	45,1	38,4	
		500	104,7	97,5	91,7	86,7	78,5	71,8	
		600	126,7	126,7	121,3	115,5	110,6	102,4	95,6
		650			122,5	114,3	107,5		
		700			126,7	126,7	126,7	126,2	119,5
					126,7	126,7	126,7	126,7	126,7
750	126,7	126,7			126,7	126,7	126,7		
φ24	150,8	270	54,4	46,5	40,2	34,8	25,8	18,5	
		360	77,8	69,9	63,6	58,2	49,2	41,9	
		650	150,8	150,8	145,3	139,1	133,6	124,7	117,3
		700			146,6	137,7	130,3		
		750			150,8	150,8	150,8	150,7	143,3
		800			150,8	150,8	150,8	150,8	150,8
φ25	163,6	280	59,4	51,1	44,6	38,9	29,6	22,0	
		360	81,1	72,8	66,3	60,6	51,3	43,6	
		700	163,6	163,6	158,4	152,8	143,4	135,8	
		750			157,0	149,3			
		800			163,6	163,6	163,6	163,6	162,9
					163,6	163,6	163,6	163,6	163,6
850	163,6	163,6			163,6	163,6	163,6		
φ26	177,0	290	64,6	56,0	49,2	43,3	33,6	25,6	
		360	84,3	75,7	68,9	63,0	53,3	45,4	
		700	177,0	177,0	171,5	164,7	158,9	149,2	141,2
		750			173,0	163,2	155,3		
		800			177,0	177,0	177,0	177,0	177,0
					177,0	177,0	177,0	177,0	177,0
850	177,0	177,0			177,0	177,0	177,0		
φ27	190,9	300	70,0	61,1	54,0	47,9	37,8	29,6	
		500	128,5	119,6	112,5	106,4	96,4	88,1	
		750	190,9	190,9	185,7	179,6	169,5	161,2	
		800			184,2	175,9			
		850			190,9	190,9	190,9	190,9	190,9
					190,9	190,9	190,9	190,9	190,9
900	190,9	190,9			190,9	190,9	190,9		
φ28	205,3	300	75,6	66,4	59,0	52,7	42,3	33,7	
		500	133,3	124,0	116,7	110,4	99,9	91,3	
		750	205,3	205,3	199,9	192,6	186,3	175,8	167,2
		800			201,4	191,0	182,4		
					205,3	205,3	205,3	205,3	205,3
		850			205,3	205,3	205,3	205,3	205,3
205,3	205,3				205,3	205,3	205,3		
900	205,3	205,3	205,3	205,3	205,3				

**Maximum force ( $F_{s,T,max}$ ) in rebar in conjunction with HIT-RE 100 as a function of embedment depth ( $\ell_{inst}$ ) for the fire resistance classes R30 to R240 according to EC2,**

Rebar-size	$F_{s,T,max}$ [kN]	$\ell_{inst}$ [mm]	Fire resistance of bar [kN]					
			R30	R60	R90	R120	R180	R240
$\phi 30$	235,6	330	87,5	77,6	69,8	63,0	51,8	42,6
		500	142,8	132,9	125,0	118,3	107,1	97,9
		800	235,6	230,4	222,6	215,8	204,6	195,4
		850		235,6	235,6	232,1	220,9	211,7
		900	235,6			235,6	235,6	235,6
		950		235,6				
$\phi 32$	268,1	350	100,3	89,7	81,4	74,1	62,2	
		500	152,3	141,8	133,4	126,2	114,2	104,4
		850	268,1	263,2	254,8	247,5	235,6	225,8
		900		268,1	268,1	264,9	252,9	243,1
		950	268,1			268,1	268,1	268,1
$\phi 34$	302,6	370	113,9	102,7	93,8	86,1	73,4	63,0
		500	161,8	150,6	141,7	134,0	121,3	110,9
		900	302,6	298,0	289,1	281,4	268,8	258,3
		950		302,6	302,6	299,9	287,2	276,8
$\phi 36$	339,3	400	132,3	120,5	111,0	102,9	89,5	78,4
		600	210,4	198,5	189,1	180,9	167,5	156,5
		800	288,4	276,5	267,1	259,0	245,5	234,5
		950	339,3	335,1	325,6	317,5	304,1	293,0
$\phi 40$	385,5	450	168,7	155,5	145,1	136,0	121,1	108,8
		600	233,8	220,6	210,1	201,0	186,1	173,9
		800	320,5	307,3	296,8	287,8	272,8	260,6
		950	385,5	372,3	361,8	352,8	337,9	325,6

\*For additional values please check GS 3,2/15-431-4 fire report,  
Characteristic yield strength  $f_{yk} = 500 \text{ N/mm}^2$

Steel failure

## b) Overlap joint application

Max, bond stress,  $f_{bd, FIRE}$ , depending on actual clear concrete cover for classifying the fire resistance,

It must be verified that the actual force in the bar during a fire,  $F_{s,T}$ , can be taken up by the bar connection of the selected length,  $l_{inst}$ , Note: Cold design for ULS is mandatory,

$$F_{s,T} \leq (l_{inst} - c_f) \cdot \phi \cdot \pi \cdot f_{bd, FIRE} \quad \text{where: } (l_{inst} - c_f) \geq l_s;$$

$l_s$  = lap length

$\phi$  = nominal diameter of bar

$l_{inst} - c_f$  = selected overlap joint length; this must be at least  $l_s$ ,

but may not be assumed to be more than  $80 \phi$

$f_{bd, FIRE}$  = bond stress when exposed to fire

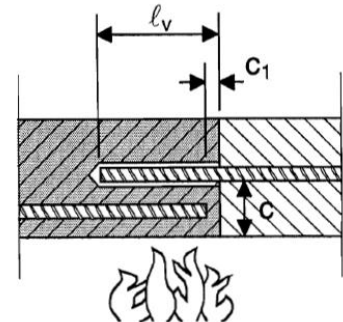

**Critical temperature-dependent bond stress,  $f_{bd, FIRE}$ , concerning “overlap joint” for Hilti HIT-RE 100 injection adhesive in relation to fire resistance class and required minimum concrete coverage c,**

Clear concrete cover c [mm]	Max, bond stress, $\tau_c$ [N/mm <sup>2</sup> ]					
	R30	R60	R90	R120	R180	R240
50	0,9					
60	1,7					
70	2,7					
80		1,0				
90		1,6				
100		2,3	1,0			
110		3,0	1,4	0,7		
120			1,9	1,0		
130			2,5	1,4		
140			3,1	1,9	0,7	
150				2,4	1,0	
160				2,9	1,3	
170	3,5			3,4	1,7	0,9
180					2,1	1,1
190		3,5			2,5	1,4
200					2,9	1,7
210			3,5		3,3	2,1
220				3,5		2,5
230						2,8
240					3,5	3,1
250						
260						3,5



## Materials

### Material quality

Part	Material
Rebar EN 1992-1-1:2004+AC:2010	Bars and de-coiled rods class B or C with $f_{yk}$ and $k$ according to NDP or NCL of EN 1992-1-1/NA:2013 $f_{uk} = f_{tk} = k \cdot f_{yk}$

### Fitness for use

Some creep tests have been conducted in accordance with ETAG guideline 001 part 5 and TR 023 in the following conditions: **in dry environment at 50 °C during 90 days**,

These tests show an excellent behaviour of the post-installed connection made with HIT-RE 100: low displacements with long term stability, failure load after exposure above reference load,

### Resistance to chemical substances

Chemical	Resistance	Chemical	Resistance
Acetic acid 100%	o	Methanol 100%	o
Acetic acid 10%	+	Peroxide of hydrogen 30%	o
Hydrochloric Acid 20%	+	Solution of phenol (sat.)	-
Nitric Acid 40%	-	Sodium hydroxide pH=14	+
Phosphoric Acid 40%	+	Solution of chlorine (sat.)	+
Sulphuric acid 40%	+	Solution of hydrocarbons (60 % vol Toluene, 30 % vol Xylene, 10 % vol Methyl naphthalene)	+
Ethyl acetate 100%	o	Salted solution 10%	+
Acetone 100%	-	sodium chloride	
Ammoniac 5%	o	Suspension of concrete (sat.)	+
Diesel 100%	+	Chloroform 100%	+
Gasoline 100%	+	Xylene 100%	+
Ethanol 96%	o		
Machine oils 100%	+		

- + resistant
- o resistant in short term (max, 48h) contact
- not resistant

### Electrical Conductivity

HIT-RE 100 in the hardened state **is not conductive electrically**, Its electric resistivity is  $1,4 \cdot 10^{10} \Omega \cdot m$  (DIN IEC 93 – 12,93), It is adapted well to realize electrically insulating anchorings (ex: railway applications, subway),

## Setting information

### Installation temperature range:

+5°C to +40°C

### Service temperature range

Hilti HIT-RE 100 injection mortar may be applied in the temperature ranges given below, An elevated base material temperature may lead to a reduction of the design bond resistance,

Temperature range	Base material temperature	Maximum long term base material temperature	Maximum short term base material temperature
Temperature range I	-40 °C to +80 °C	+50 °C	+80 °C

### Maximum short term base material temperature

Short-term elevated base material temperatures are those that occur over brief intervals, e.g, as a result of diurnal cycling,

### Maximum long term base material temperature

Long-term elevated base material temperatures are roughly constant over significant periods of time,

### Working time and curing time<sup>a)</sup>

Temperature of the base material	Maximum working time	Initial curing time	Minimum curing time
$T_{BM}$	$t_{work}$	$t_{cure,ini}^{b)}$	$t_{cure}$
$5\text{ °C} \leq T_{BM} < 9\text{ °C}$	2 hours	18 hours	72 hours
$10\text{ °C} \leq T_{BM} < 14\text{ °C}$	1,5 hours	12 hours	48 hours
$15\text{ °C} \leq T_{BM} < 19\text{ °C}$	30 min	8 hours	24 hours
$20\text{ °C} \leq T_{BM} < 24\text{ °C}$	25 min	6 hours	12 hours
$25\text{ °C} \leq T_{BM} < 29\text{ °C}$	20 min	5 hours	10 hours
$30\text{ °C} \leq T_{BM} \leq 39\text{ °C}$	12 min	4 hours	8 hours
40 °C	12 min	2 hours	4 hours

a) The curing time data are valid for dry base material only, In wet base material the curing times must be doubled,

b) After  $t_{cure,ini}$  has elapsed preparation work may continue

### Installation equipment

Rebar – size	$\phi 8\text{-}\phi 16$	$\phi 18\text{-}\phi 40$
Rotary hammer	TE2(-A) – TE30(-A)	TE40 – TE80
Other tools	Blow out pump ( $h_{ef} \leq 10 \cdot d$ )	-
	Compressed air gun <sup>a)</sup> Set of cleaning brushes <sup>b)</sup> , dispenser, piston plug	

a) Compressed air gun with extension hose for all drill holes deeper than 250 mm (for  $\phi 8$  to  $\phi 12$ ) or deeper than  $20 \cdot \phi$  (for  $\phi > 12$  mm)

b) Automatic brushing with round brush for all drill holes deeper than 250 mm (for  $\phi 8$  to  $\phi 12$ ) or deeper than  $20 \cdot \phi$  (for  $\phi > 12$  mm)

### Minimum concrete cover $c_{min}$ of the post-installed rebar

Drilling method	Rebar – size [mm]	Minimum concrete cover $c_{min}$ [mm]	
		Without drilling aid	With drilling aid
Hammer drilling (HD)	$\phi < 25$	$30 + 0,06 \cdot l_v \geq 2 \cdot \phi$	$30 + 0,02 \cdot l_v \geq 2 \cdot \phi$
	$\phi \geq 25$	$40 + 0,06 \cdot l_v \geq 2 \cdot \phi$	$40 + 0,02 \cdot l_v \geq 2 \cdot \phi$
Compressed air drilling (CA)	$\phi < 25$	$50 + 0,08 \cdot l_v$	$50 + 0,02 \cdot l_v$
	$\phi \geq 25$	$60 + 0,08 \cdot l_v \geq 2 \cdot \phi$	$60 + 0,02 \cdot l_v \geq 2 \cdot \phi$
Diamond coring dry (PCC) or wet (DD)	$\phi < 25$	Drill stand is used as drilling aid	$30 + 0,02 \cdot l_v \geq 2 \cdot \phi$
	$\phi \geq 25$		$40 + 0,02 \cdot l_v \geq 2 \cdot \phi$

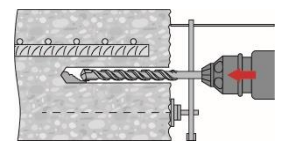

**Drilling and cleaning diameters**

Rebar [mm]	Drilling					Cleaning	
	Hammer drill (HD)	Compressed air drill (CA)	Hollow Drill Bit (HDB)	Wet (DD)	Dry (PCC) <sup>b)</sup>	Brush HIT-RB	Air nozzle HIT-RB
	d <sub>0</sub> [mm]					size [mm]	
φ8	12 (10 <sup>a)</sup> )	-	-	12 (10 <sup>a)</sup> )	-	12 (10 <sup>a)</sup> )	12 (10 <sup>a)</sup> )
φ10	14 (12 <sup>a)</sup> )	-	-	14 (12 <sup>a)</sup> )	-	14 (12 <sup>a)</sup> )	14 (12 <sup>a)</sup> )
φ12	16 (14 <sup>a)</sup> )	-	-	16 (14 <sup>a)</sup> )	-	16 (14 <sup>a)</sup> )	16 (14 <sup>a)</sup> )
	-	17	-	-	-	18	16
φ14	18	17	-	18	-	18	18
φ16	20	-	-	20	-	20	20
	-	20	-	-	-	22	20
φ18	22	22	-	22	-	22	22
φ20	25 (24 <sup>a)</sup> )	-	-	25	-	25 (24 <sup>a)</sup> )	25 (24 <sup>a)</sup> )
	-	26	-	-	-	28	25
φ22	28	28	-	28	-	28	28
φ24	32	32	-	32	-	32	32
	-	-	35	-	35	-	
φ25	32 (30 <sup>a)</sup> )	32 (30 <sup>a)</sup> )	-	32 (30 <sup>a)</sup> )	-	32 (30 <sup>a)</sup> )	
	-	-	35	-	35	-	
φ26	35	35	35	35	35	35	
φ28	35	35	35	35	35	35	
φ30	-	35	35	35	35	35	
	37	-	-	-		37	
φ32	40	40	47	40	47	40	
φ34	-	42	-	42	47	42	
	45	-	47	-		45	
φ36	45	45	-	-	47	45	
	-	-	47	47		47	
φ40	-	-	52	52	52	52	
	55	57	-	-		55	

a) Both of a given values can be used,

b) No cleaning required,

**Dispenser and corresponding maximum embedment depth  $l_{v,max}$** 

Rebar	Dispenser	
	HDM 330, HDM 500	HDE 500
	$l_{v,max}$ [mm]	
φ8 to φ10	1000	1000
φ12 to φ14		1200
φ16		1500
φ18 to φ20	700	1300
φ22 to φ25		1000
φ26 to φ28	500	700
φ30 to φ32		-
φ34 to φ40		500

## Setting instructions

\*For detailed information on installation see instruction for use given with the package of the product,



### Safety regulations,

Review the Material Safety Data Sheet (MSDS) before use for proper and safe handling! Wear well-fitting protective goggles and protective gloves when working with Hilti HIT-RE 100,

## Drilling

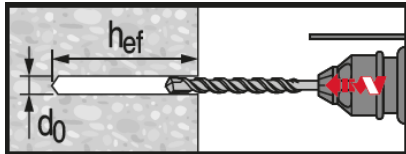

### Hammer drilled hole

For dry and wet concrete,

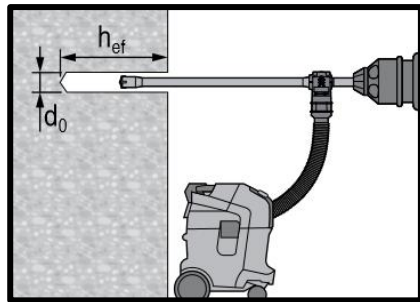

### Hammer drilled hole with Hollow Drilled Bit (HDB)

No cleaning required,

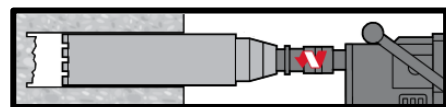

### Diamond Drilling (DD)

## Cleaning

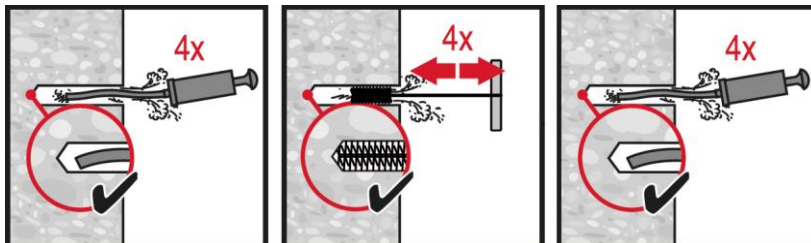

### Hammer Drilling:

#### Manual cleaning (MC)

for drill diameters  $d_0 \leq 20$  mm and drill hole depth  $h_0 \leq 10 \cdot d_0$ ,

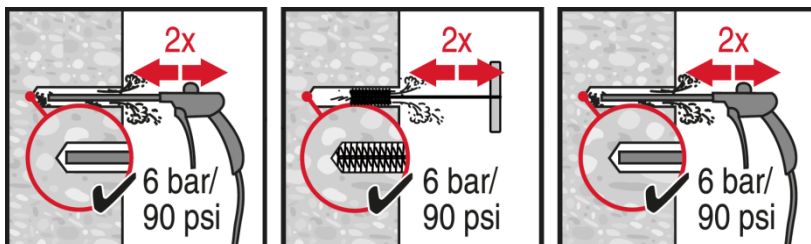

### Hammer Drilling:

#### Compressed air cleaning (CAC)

for all drill hole diameters  $d_0$  and drill hole depths  $h_0 \leq 20 \cdot d_0$ ,

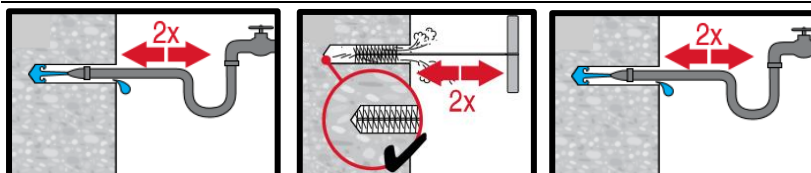

### Wet diamond coring:

#### Compressed air cleaning (CAC)

for all drill hole diameters  $d_0$  and drill hole depths  $h_0$ ,

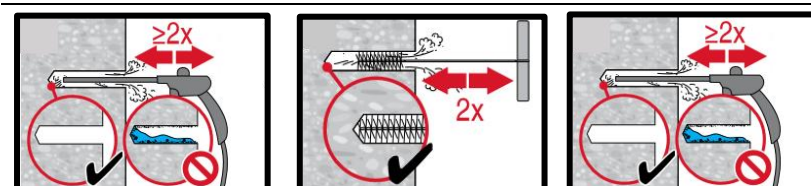

### Dry diamond coring:

#### Compressed air cleaning (CAC)

for all drill hole diameters  $d_0$  and drill hole depths  $h_0$ ,

**System preparation**

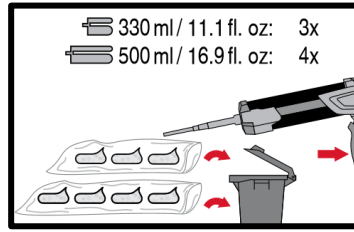
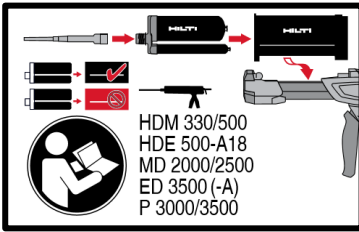

**Injection system preparation,**

**Inject adhesive**

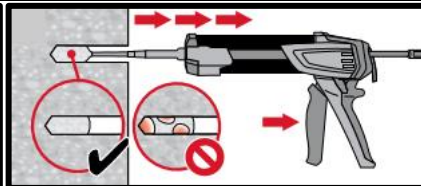
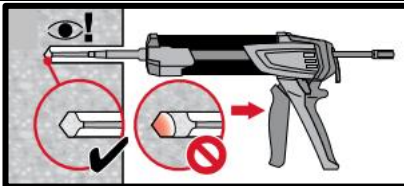

**Injection method for drill hole depth**  
 $h_{ef} \leq 250 \text{ mm},$

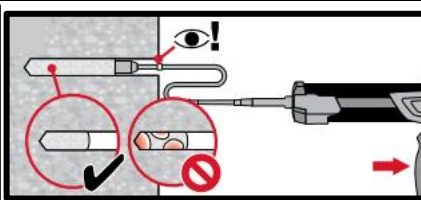
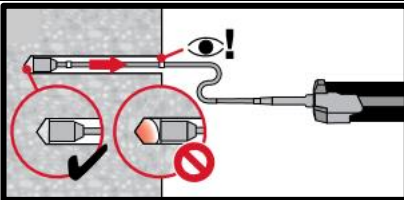

**Injection method for drill hole depth**  
 $h_{ef} > 250 \text{ mm},$

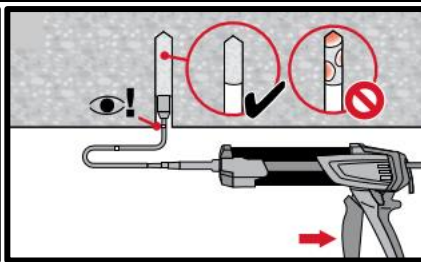
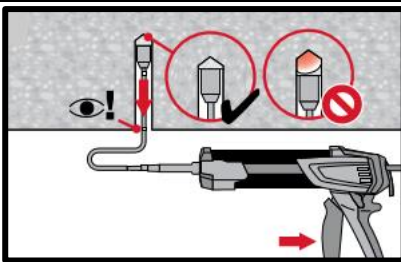

**Injection method for overhead**  
**application,**

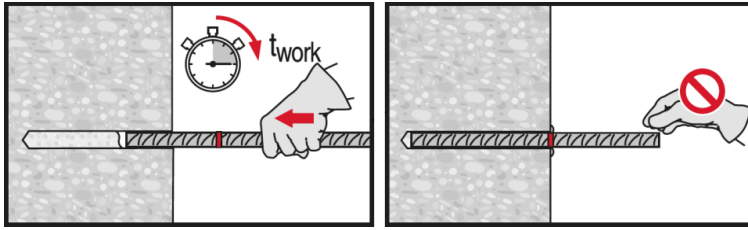
**Setting the element**

**Setting element**, observe working time “ $t_{work}$ ”,

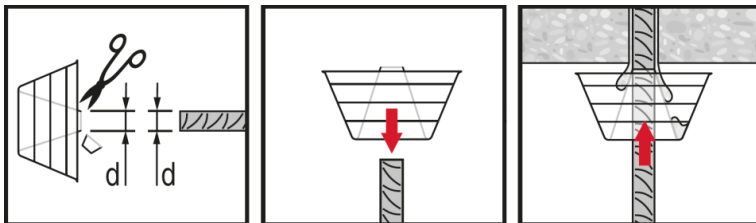

**Setting element for overhead applications**, observe working time “ $t_{work}$ ”,

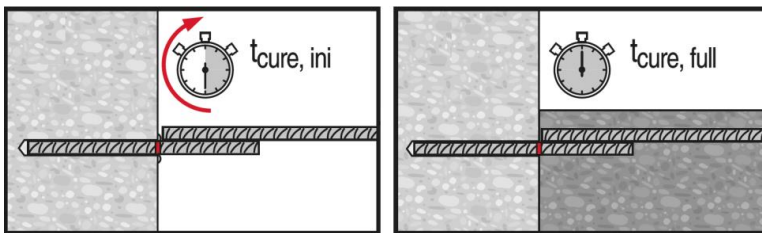
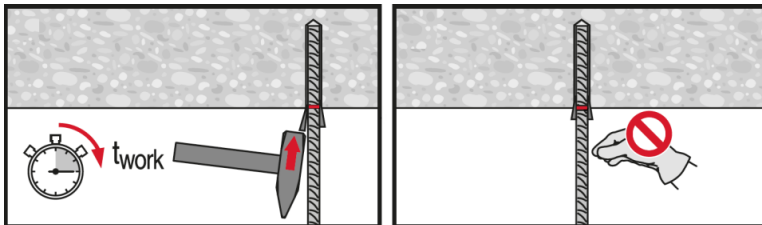

Apply full load only after curing time “ $t_{cure}$ ”

### 2.1.7 HIT-RE 100 hard cartridges

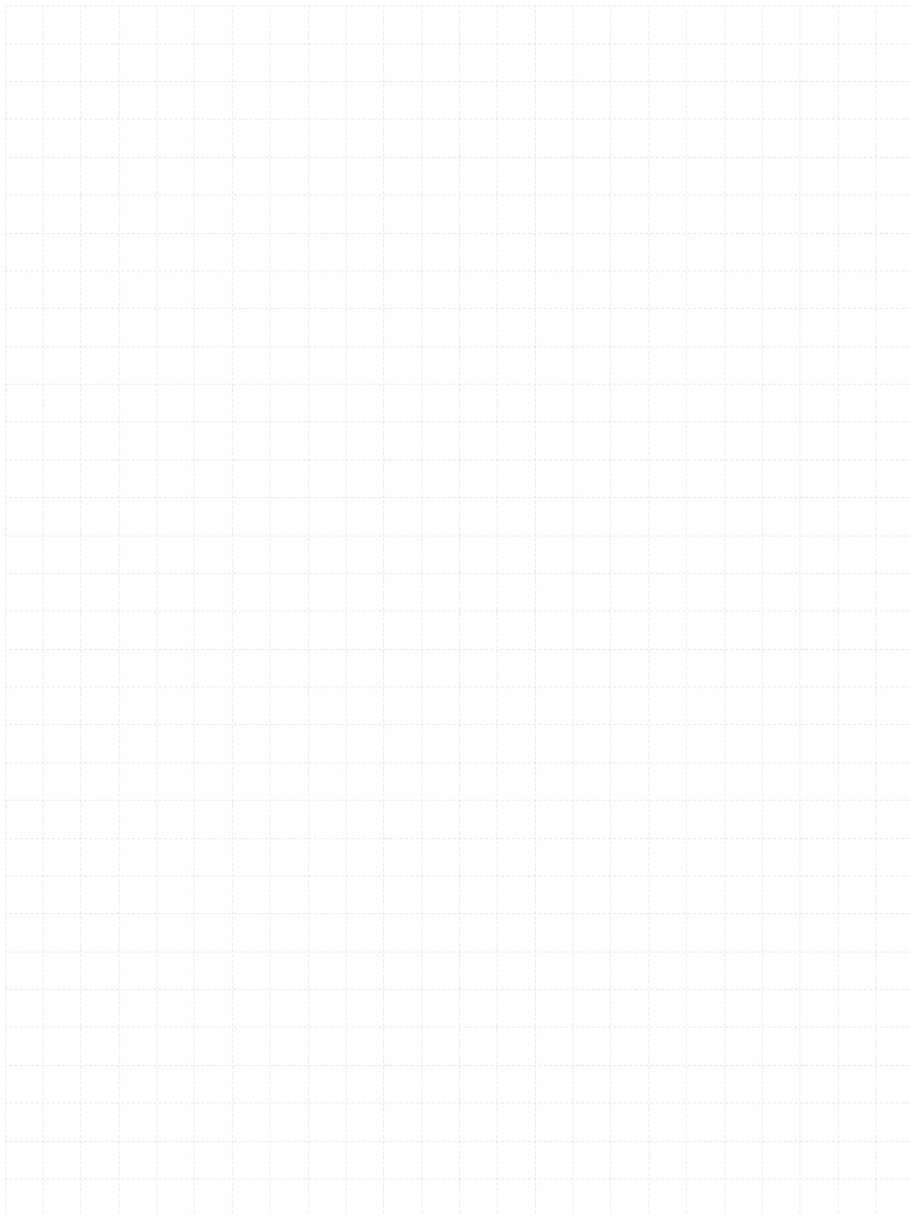



# HIT-RE 100-HC injection mortar

Anchor design (EN 1992-4) / Rods&Sleeves / Concrete

## Injection mortar system



Hilti HIT-RE 100-HC  
580 ml hard cartridge



Anchor rods:  
HAS-U  
HAS-U HDG  
HAS-U A4  
HAS-U HCR  
(M8-M30)

## Benefits

- Suitable for cracked and uncracked concrete C 20/25 to C 50/60
- High loading capacity
- Suitable for dry and water saturated concrete
- Large diameter applications
- Long working time at elevated temperatures
- Odourless epoxy

## Base material



Concrete (uncracked)

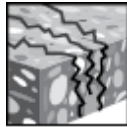

Concrete (cracked)



Dry concrete



Wet concrete

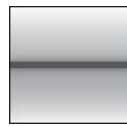

Static/  
quasi-static

## Load conditions

## Installation conditions

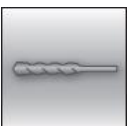

Hammer  
drilling

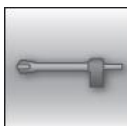

Hollow drill-  
bit drilling

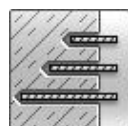

Variable  
embedment  
depth

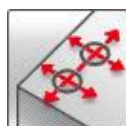

Small edge  
distance and  
spacing

## Other informations



European  
Technical  
Assessment



CE  
conformity

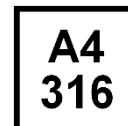

Corrosion  
resistance



High  
corrosion  
resistance

## Approvals / certificates

Description	Authority / Laboratory	No. / date of issue
European technical assessment <sup>a)</sup>	DIBt, Berlin	ETA-19/0148 / 2019-12-13

<sup>a)</sup> All data given in this section according to ETA-19/0148, issue 2019-12-13.



## Static and quasi-static loading (for a single anchor)

### All data in this section applies to

- Correct setting (See setting instruction)
- No edge distance and spacing influence
- Steel failure
- Anchor HAS-U with strength 5.8
- Base material thickness, as specified in the table
- One typical embedment depth, as specified in the table
- Concrete C 20/25,  $f_{ck,cube} = 25 \text{ N/mm}^2$
- Temperate range I  
(min. base material temperature  $-40^\circ\text{C}$ , max. long term/short term base material temperature:  $+24^\circ\text{C}/40^\circ\text{C}$ )

### Embedment depth and base material thickness

Anchor size	ETA-19/0148, issue 2019-12-13								Hilti technical data		
	M8	M10	M12	M16	M20	M24	M27	M30	M33	M36	M39
HAS-U											
Eff. anchorage depth [mm]	80	90	110	125	170	210	240	270	300	330	360
Base material thickness [mm]	110	120	140	160	220	270	300	340	380	410	450

### Characteristic resistance

Anchor size	ETA-19/0148, issue 2019-12-13								Hilti technical data			
	M8	M10	M12	M16	M20	M24	M27	M30	M33	M36	M39	
<b>Non-cracked concrete</b>												
Tension $N_{Rk}$	HAS-U 5.8	18,0	29,0	42,0	68,7	109	150	183	218	256	295	336
	HAS-U 8.8	29,0	42,0	56,8	68,7	109	150	183	218	256	295	336
	HAS-U A4	26,0	41,0	56,8	68,7	109	150	183	218	256	295	336
	HAS-U HCR	29,0	42,0	56,8	68,7	109	150	183	218	256	295	336
Shear $V_{Rk}$	HAS-U 5.8	9,0	15,0	21,0	39,0	61,0	88,0	115	140	174	204	244
	HAS-U 8.8	15,0	23,0	34,0	63,0	98,0	141	184	224	278	327	390
	HAS-U A4	13,0	20,0	30,0	55,0	86,0	124	115	140	174	204	244
	HAS-U HCR	15,0	23,0	34,0	63,0	98,0	124	161	196	174	204	244
<b>Cracked concrete</b>												
Tension $N_{Rk}$	HAS-U 5.8	-	19,8	29,0	40,8	64,1	95,0	112	140	156	187	221
	HAS-U 8.8	-	19,8	29,0	40,8	64,1	95,0	112	140	156	187	221
	HAS-U A4	-	19,8	29,0	40,8	64,1	95,0	112	140	156	187	221
	HAS-U HCR	-	19,8	29,0	40,8	64,1	95,0	112	140	156	187	221
Shear $V_{Rk}$	HAS-U 5.8	-	15,0	21,0	39,0	61,0	88,0	115	140	174	204	244
	HAS-U 8.8	-	23,0	34,0	63,0	98,0	141	184	224	278	327	390
	HAS-U A4	-	20,0	30,0	55,0	86,0	124	115	140	174	204	244
	HAS-U HCR	-	23,0	34,0	63,0	98,0	124	161	196	174	204	244

**Design resistance**

Anchor size		ETA-19/0148, issue 2019-12-13								Hilti technical data			
		M8	M10	M12	M16	M20	M24	M27	M30	M33	M36	M39	
<b>Non-cracked concrete</b>													
Tension $N_{Rd}$	HAS-U 5.8	[kN]	12,0	19,3	27,0	32,7	51,9	71,3	87,1	104	122	140	160
	HAS-U 8.8	[kN]	14,4	20,0	27,0	32,7	51,9	71,3	87,1	104	122	140	160
	HAS-U A4	[kN]	13,9	20,0	27,0	32,7	51,9	71,3	80,4	98,3	121	140	160
	HAS-U HCR	[kN]	14,4	20,0	27,0	32,7	51,9	71,3	87,1	104	122	140	160
Shear $V_{Rd}$	HAS-U 5.8	[kN]	7,2	12,0	16,8	31,2	48,8	70,4	92,0	112	139	163	195
	HAS-U 8.8	[kN]	12,0	18,4	27,2	50,4	78,4	113	147	179	222	262	312
	HAS-U A4	[kN]	8,3	12,8	19,2	35,3	55,1	79,5	48,3	58,8	73,1	85,7	103
	HAS-U HCR	[kN]	12,0	18,4	27,2	50,4	78,4	70,9	92,0	157	87,0	102	122
<b>Cracked concrete</b>													
Tension $N_{Rd}$	HAS-U 5.8	[kN]	-	9,4	13,8	19,4	30,5	45,2	53,3	66,6	74,1	88,9	105
	HAS-U 8.8	[kN]	-	9,4	13,8	19,4	30,5	45,2	53,3	66,6	74,1	88,9	105
	HAS-U A4	[kN]	-	9,4	13,8	19,4	30,5	45,2	53,3	66,6	74,1	88,9	105
	HAS-U HCR	[kN]	-	9,4	13,8	19,4	30,5	45,2	53,3	66,6	74,1	88,9	105
Shear $V_{Rd}$	HAS-U 5.8	[kN]	-	12,0	16,8	31,2	48,8	70,4	92,0	112	139	163	195
	HAS-U 8.8	[kN]	-	18,4	27,2	50,4	78,4	113	147	179	207	249	294
	HAS-U A4	[kN]	-	12,8	19,2	35,3	55,1	79,5	48,3	58,8	73,1	85,7	103
	HAS-U HCR	[kN]	-	18,4	27,2	50,4	78,4	70,9	92,0	112	87,0	102	122

**Recommended loads<sup>a)</sup>**

Anchor size		ETA-19/0148, issue 2019-12-13								Hilti technical data			
		M8	M10	M12	M16	M20	M24	M27	M30	M33	M36	M39	
<b>Non-cracked concrete</b>													
Tension $N_{rec}$	HAS-U 5.8	[kN]	8,6	13,8	19,3	23,4	37,1	50,9	62,2	74,2	86,9	100	114
	HAS-U 8.8	[kN]	10,3	14,3	19,3	23,4	37,1	50,9	62,2	74,2	86,9	100	114
	HAS-U A4	[kN]	9,9	14,3	19,3	23,4	37,1	50,9	57,4	70,2	86,7	100	114
	HAS-U HCR	[kN]	10,3	14,3	19,3	23,4	37,1	50,9	62,2	74,2	86,9	100	114
Shear $V_{rec}$	HAS-U 5.8	[kN]	5,1	8,6	12,0	22,3	34,9	50,3	65,7	80,0	99,4	117	139
	HAS-U 8.8	[kN]	8,6	13,1	19,4	36,0	56,0	80,6	105	128	159	187	223
	HAS-U A4	[kN]	6,0	9,2	13,7	25,2	39,4	56,8	34,5	42,0	52,2	61,2	73,2
	HAS-U HCR	[kN]	8,6	13,1	19,4	36,0	56,0	50,6	65,7	112	62,1	72,9	87,1
<b>Cracked concrete</b>													
Tension $N_{rec}$	HAS-U 5.8	[kN]	-	6,7	9,9	13,9	21,8	32,3	38,1	47,6	52,9	63,5	75,0
	HAS-U 8.8	[kN]	-	6,7	9,9	13,9	21,8	32,3	38,1	47,6	52,9	63,5	75,0
	HAS-U A4	[kN]	-	6,7	9,9	13,9	21,8	32,3	38,1	47,6	52,9	63,5	75,0
	HAS-U HCR	[kN]	-	6,7	9,9	13,9	21,8	32,3	38,1	47,6	52,9	63,5	75,0
Shear $V_{rec}$	HAS-U 5.8	[kN]	-	8,6	12,0	22,3	34,9	50,3	65,7	80,0	99,4	117	139
	HAS-U 8.8	[kN]	-	13,1	19,4	36,0	56,0	80,6	105	128	148	178	210
	HAS-U A4	[kN]	-	9,2	13,7	25,2	39,4	56,8	34,5	42,0	52,2	61,2	73,2
	HAS-U HCR	[kN]	-	13,1	19,4	36,0	56,0	50,6	65,7	80,0	62,1	72,9	87,1

a) With overall partial safety factor for action  $\gamma=1,4$ . The partial safety factors for action depend on the type of loading and shall be taken from national regulations.

**Materials**
**Mechanical properties**

Anchor size			M8	M10	M12	M16	M20	M24	M27	M30
Nominal tensile strength $f_{uk}$	HAS-U 5.8	[N/mm <sup>2</sup> ]	500	500	500	500	500	500	-	-
	HAS-U 8.8	[N/mm <sup>2</sup> ]	800	800	800	800	800	800	800	800
	HAS-U A4	[N/mm <sup>2</sup> ]	700	700	700	700	700	700	500	500
	HAS-U HCR	[N/mm <sup>2</sup> ]	800	800	800	800	800	700	-	-
Yield strength $f_{yk}$	HAS-U 5.8	[N/mm <sup>2</sup> ]	440	440	440	440	400	400	-	-
	HAS-U 8.8	[N/mm <sup>2</sup> ]	640	640	640	640	640	640	640	640
	HAS-U A4	[N/mm <sup>2</sup> ]	450	450	450	450	450	450	210	210
	HAS-U HCR	[N/mm <sup>2</sup> ]	640	640	640	640	640	400	-	-
Stressed cross-section $A_s$	HAS-U	[mm <sup>2</sup> ]	36,6	58,0	84,3	157	245	353	459	561
Moment of resistance W	HAS-U	[mm <sup>3</sup> ]	31,2	62,3	109	277	541	935	1387	1874

**Material quality for HAS-U**

Part	Material
<b>Zinc coated steel</b>	
Threaded rod, HAS-U 5.8 (HDG)	Strength class 5.8; Elongation at fracture A5 > 8% ductile Electroplated zinc coated $\geq 5\mu\text{m}$ ; (F) hot dip galvanized $\geq 45\mu\text{m}$
Threaded rod, HAS-U 8.8 (HDG)	Strength class 8.8; Elongation at fracture A5 > 12% ductile Electroplated zinc coated $\geq 5\mu\text{m}$ ; (F) hot dip galvanized $\geq 45\mu\text{m}$
Washer	Electroplated zinc coated $\geq 5\mu\text{m}$ , hot dip galvanized $\geq 45\mu\text{m}$
Nut	Strength class of nut adapted to strength class of threaded rod. Electroplated zinc coated $\geq 5\mu\text{m}$ , hot dip galvanized $\geq 45\mu\text{m}$
<b>Stainless Steel</b> corrosion resistance class III acc. to EN 1993-1-4:2006+A1:2015	
Threaded rod, HAS-U A4	Strength class 70 for $\leq M24$ and strength class 50 for $> M24$ ; Elongation at fracture A5 > 8% ductile
Washer	Stainless steel 1.4401, 1.4404, 1.4578, 1.4571, 1.4439, 1.4362 EN 10088-1:2014
Nut	Stainless steel 1.4401, 1.4404, 1.4578, 1.4571, 1.4439, 1.4362 EN 10088-1:2014
<b>High corrosion resistant steel</b> corrosion resistance class V acc. to EN 1993-1-4:2006+A1:2015	
Threaded rod, HAS-U HCR	Strength class 80 for $\leq M20$ and class 70 for $> M20$ , Elongation at fracture A5 > 8% ductile
Washer	High corrosion resistant steel 1.4529, 1.4565 EN 10088-1:2014
Nut	High corrosion resistant steel 1.4529, 1.4565 EN 10088-1:2014

## Setting information

### Installation temperature range:

+5°C to +40°C

### Service temperature range

Hilti HIT-RE 100-HC injection mortar may be applied in the temperature ranges given below. An elevated base material temperature may lead to a reduction of the design bond resistance.

Temperature range	Base material temperature	Max. long term base material temperature	Max. short term base material temperature
Temperature range I	-40 °C to + 40 °C	+ 24 °C	+ 40 °C
Temperature range II	-40 °C to + 58 °C	+ 35 °C	+ 58 °C
Temperature range III	-40 °C to + 70 °C	+ 43 °C	+ 70 °C

### Max. short term base material temperature

Short term elevated base material temperatures are those that occur over brief intervals, e.g. as a result of diurnal cycling.

### Max. long term base material temperature

Long term elevated base material temperatures are roughly constant over significant periods of time.

### Working time and curing time

Temperature of the base material	Max. working time in which rebar can be inserted and adjusted $t_{work}$	Min. curing time before rebar can be fully loaded $t_{cure}$
$5\text{ °C} \leq T_{BM} < 10\text{ °C}$	2,5 h	72 h
$10\text{ °C} \leq T_{BM} < 15\text{ °C}$	2 h	48 h
$15\text{ °C} \leq T_{BM} < 20\text{ °C}$	1 h	24 h
$20\text{ °C} \leq T_{BM} < 30\text{ °C}$	40 min	18 h
$30\text{ °C} \leq T_{BM} \leq 40\text{ °C}$	20 min	6 h

The curing time data are valid for dry base material only. In wet base material the curing times must be doubled.

**Setting details for HAS-U**

Anchor size		M8	M10	M12	M16	M20	M24	M27	M30	
Nominal diameter of drill bit	$d_0$ [mm]	10	12	14	18	22	28	30	35	
Diameter of element	$d$ [mm]	8	10	12	16	20	24	27	30	
Effective anchorage and drill hole depth	$h_{ef}$ [mm]	60 to 160	60 to 200	70 to 240	80 to 320	90 to 400	96 to 480	108 to 540	120 to 600	
Minimum base material thickness	$h_{min}$ [mm]	$h_{ef} + 30 \geq 100$ mm				$h_{ef} + 2 d_0$				
Diameter of clearance hole in the fixture	$d_f$ [mm]	9	12	14	18	22	26	30	33	
Minimum spacing	$s_{min}$ [mm]	40	50	60	75	90	115	120	140	
Minimum edge distance	$c_{min}$ [mm]	40	45	45	50	55	60	75	80	
Critical spacing for splitting failure	$s_{cr,sp}$ [mm]	$2 C_{cr,sp}$								
Critical edge distance for splitting failure <sup>a)</sup>	$c_{cr,sp}$ [mm]	$1,0 \cdot h_{ef}$ for $h / h_{ef} \geq 2,0$								
		$4,6 h_{ef} - 1,8 h$ for $2,0 > h / h_{ef} > 1,3$								
		$2,26 h_{ef}$ for $h / h_{ef} \leq 1,3$								
Critical spacing for concrete cone failure	$s_{cr,N}$ [mm]	$2 C_{cr,N}$								
Critical edge distance for concrete cone failure <sup>b)</sup>	$c_{cr,N}$ [mm]	$1,5 h_{ef}$								
Torque moment <sup>c)</sup>	$T_{max}$ [Nm]	10	20	40	80	150	200	270	300	

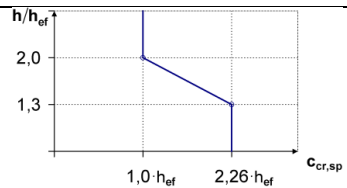

For spacing (edge distance) smaller than critical spacing (critical edge distance) the design loads have to be reduced.

- a)  $h_{ef,min} \leq h_{ef} \leq h_{ef,max}$  ( $h_{ef}$ : embedment depth)  $h$ : base material thickness ( $h \geq h_{min}$ )  
 b) The critical edge distance for concrete cone failure depends on the embedment depth  $h_{ef}$  and the design bond resistance. The simplified formula given in this table is on the safe side.  
 c) This is the maximum recommended torque moment to avoid splitting failure during installation for anchors with minimum spacing and/or edge distance.

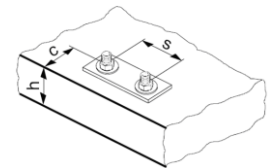
**Installation equipment**

Anchor size	M8	M10	M12	M16	M20	M24	M27	M30	
Rotary hammer	TE 2– TE 16				TE 40 – TE 80				
Other tools	Compressed air gun or blow out pump Set of cleaning brushes, dispenser, piston plug								

**Drilling and cleaning parameters**

HAS-U	Drill bit diameters $d_0$ [mm]		Installation size [mm]	
	Hammer drill (HD)	Hollow Drill Bit (HDB)	Brush HIT-RB	Piston plug HIT-SZ
<b>M8</b>	10	-	10	-
<b>M10</b>	12	12	12	<b>12</b>
<b>M12</b>	14	14	14	<b>14</b>
<b>M16</b>	18	18	18	<b>18</b>
<b>M20</b>	22	22	22	<b>22</b>
<b>M24</b>	28	28	28	<b>28</b>
<b>M27</b>	30	-	30	<b>30</b>
<b>M30</b>	35	35	35	<b>35</b>

## Setting instructions

\*For detailed information on installation see instruction for use given with the package of the product.



### Safety regulations.

Review the Material Safety Data Sheet (MSDS) before use for proper and safe handling! Wear well-fitting protective goggles and protective gloves when working with Hilti HIT-RE 100-HC.

### Drilling

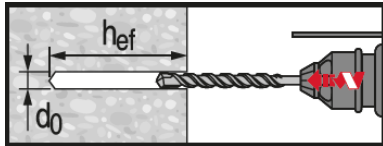

#### Hammer drilled hole

For dry and wet concrete.

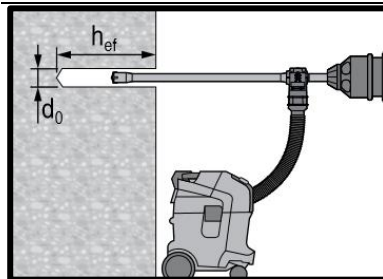

#### Hammer drilled hole with Hollow Drilled Bit (HDB)

No cleaning required.

### Cleaning

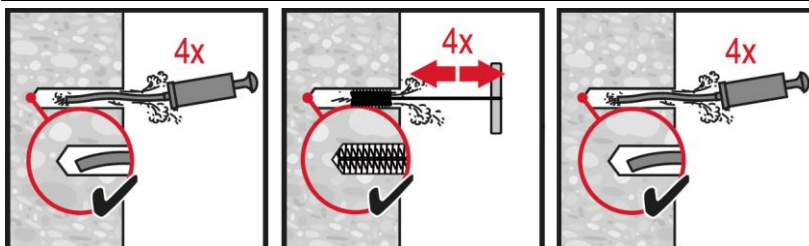

#### Manual cleaning (MC) Non-cracked concrete only

for drill diameters  $d_0 \leq 20$  mm and drill hole depths  $h_0 \leq 10 \cdot d$ .

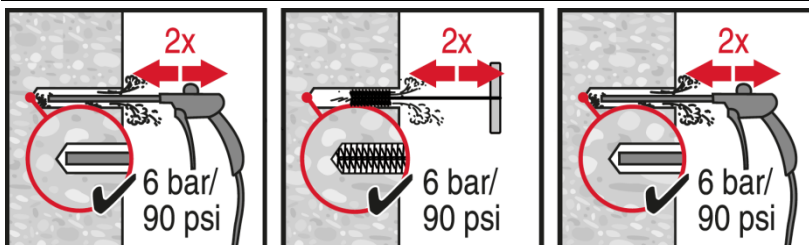

#### Compressed air cleaning (CAC)

for all drill hole diameters  $d_0$  and drill hole depths  $h_0 \leq 20 \cdot d$ .

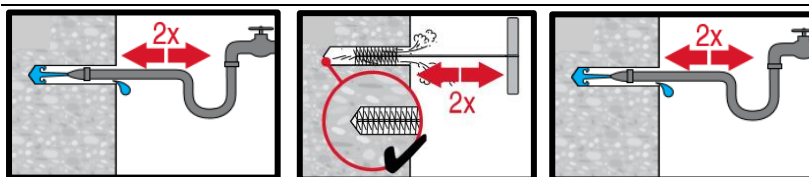

#### Compressed air cleaning (CAC) cleaning of water-filled holes

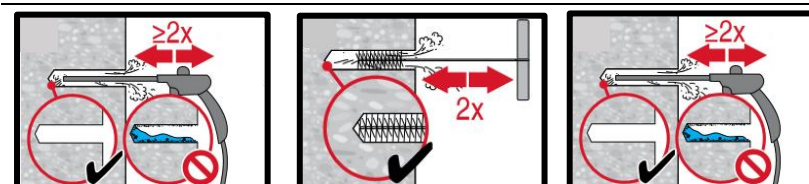

for all drill hole diameters  $d_0$  and drill hole depths  $h_0 \geq 20 \cdot d$ .

### Injection system

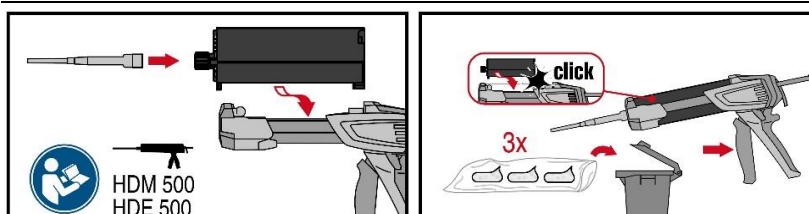

#### Injection system preparation.

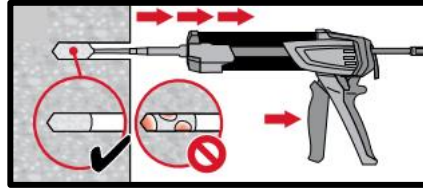

**Injection method** for drill hole depth  $h_{ef} \leq 250$  mm.

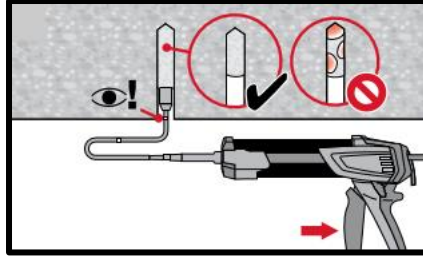
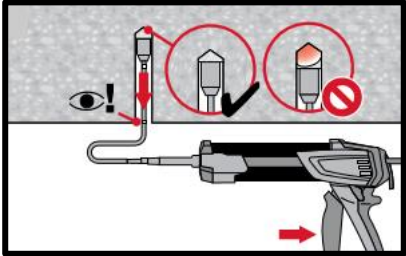

**Injection method** for overhead application and/or installation with embedment depth  $h_{ef} > 250$  mm.

**Setting the element**

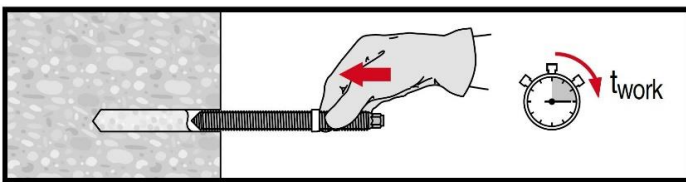

**Setting element**, observe working time " $t_{work}$ ",

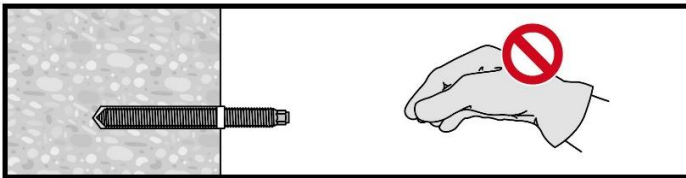

**Setting element** for overhead applications, observe working time " $t_{work}$ ",

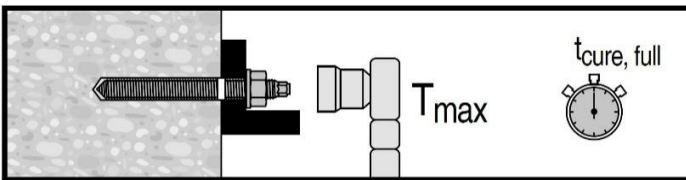





**Loading the anchor:** After required curing time  $t_{cure}$  the anchor can be loaded.

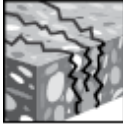
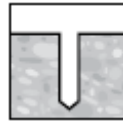
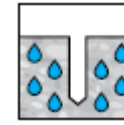
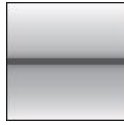

# HIT-RE 100-HC injection mortar

Anchor design (EN 1992-4) / Rebar elements / Concrete

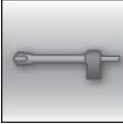
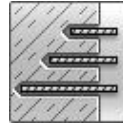
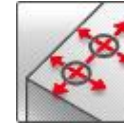
Injection mortar system	Benefits
 <p>Hilti HIT-RE 100-HC 580 ml hard cartridge</p>  <p>Rebar B500B (φ8-φ32)</p>	<ul style="list-style-type: none"> <li>- Suitable for cracked and uncracked concrete C 20/25 to C 50/60</li> <li>- High loading capacity</li> <li>- Suitable for dry and water saturated concrete</li> <li>- Large diameter applications</li> <li>- Long working time at elevated temperatures</li> <li>- Odourless epoxy</li> </ul>

Base material	Load conditions
 <p>Concrete (uncracked)</p>  <p>Concrete (cracked)</p>  <p>Dry concrete</p>  <p>Wet concrete</p>	 <p>Static/ quasi-static</p>
Installation conditions	Other informations
 <p>Hammer drilling</p>  <p>Hollow drill-bit drilling</p>  <p>Variable embedment depth</p>  <p>Small edge distance and spacing</p>	 <p>European Technical Assessment</p>  <p>CE conformity</p>

## Approvals / certificates

Description	Authority / Laboratory	No. / date of issue
European technical assessment <sup>a)</sup>	DIBt, Berlin	ETA-19/0148 / 2019-12-13

a) All data given in this section according to ETA-19/0148, issue 2019-12-13.



**Static and quasi-static loading (for a single anchor)**
**All data in this section applies to**

- Correct setting (See setting instruction)
- No edge distance and spacing influence
- Steel failure
- Base material thickness, as specified in the table
- One typical embedment depth, as specified in the table
- One anchor material, as specified in the tables
- Concrete C 20/25,  $f_{ck,cube} = 25 \text{ N/mm}^2$
- Temperate range I  
(min. base material temperature  $-40^\circ\text{C}$ , max. long term/short term base material temperature:  $+24^\circ\text{C}/40^\circ\text{C}$ )

**Embedment depth and base material thickness for static and quasi-static loading data**

Anchor- size	ETA-19/0148, issue 2019-12-13											Hilti technical data	
	$\phi 8$	$\phi 10$	$\phi 12$	$\phi 14$	$\phi 16$	$\phi 20$	$\phi 25$	$\phi 26$	$\phi 28$	$\phi 30$	$\phi 32$	$\phi 36$	$\phi 40$
Typical embedment [mm]	80	90	110	125	125	170	210	240	270	270	300	330	360
Base material thickness [mm]	110	120	140	160	170	220	280	310	340	350	380	420	470

**Characteristic resistance**

Anchor- size B500 B	ETA-19/0148, issue 2019-12-13											Hilti technical data	
	$\phi 8$	$\phi 10$	$\phi 12$	$\phi 14$	$\phi 16$	$\phi 20$	$\phi 25$	$\phi 26$	$\phi 28$	$\phi 30$	$\phi 32$	$\phi 36$	$\phi 40$
<b>Non-cracked concrete</b>													
Tensile $N_{Rk}$ [kN]	24,1	33,9	49,8	60,5	68,7	109	150	183	218	218	256	295	336
Shear $V_{Rk}$ [kN]	14,0	22,0	31,0	42,0	55,0	86,0	135	146	169	194	221	280	346
<b>Cracked concrete</b>													
Tensile $N_{Rk}$ [kN]	-	12,7	18,7	22,0	25,1	37,4	57,7	58,8	71,3	76,3	90,5	112	136
Shear $V_{Rk}$ [kN]	-	22,0	31,0	42,0	50,3	74,8	116	118	143	153	181	224	271

**Design resistance**

Anchor- size B500 B	ETA-19/0148, issue 2019-12-13											Hilti technical data	
	$\phi 8$	$\phi 10$	$\phi 12$	$\phi 14$	$\phi 16$	$\phi 20$	$\phi 25$	$\phi 26$	$\phi 28$	$\phi 30$	$\phi 32$	$\phi 36$	$\phi 40$
<b>Non-cracked concrete</b>													
Tensile $N_{Rd}$ [kN]	11,5	16,2	23,7	28,8	32,7	51,9	71,3	87,1	104	104	122	140	160
Shear $V_{Rd}$ [kN]	9,3	14,7	20,7	28,0	36,7	57,3	90,0	97,3	113	129	147	187	231
<b>Cracked concrete</b>													
Tensile $N_{Rd}$ [kN]	-	6,1	8,9	10,5	12,0	17,8	27,5	28,0	33,9	36,4	43,1	53,3	64,6
Shear $V_{Rd}$ [kN]	-	14,7	20,7	28,0	33,5	49,8	77,0	78,4	95,0	102	121	149	181

**Recommended loads <sup>a)</sup>**

Anchor- size B500 B	ETA-19/0148, issue 2019-12-13											Hilti technical data	
	φ8	φ10	φ12	φ14	φ16	φ20	φ25	φ26	φ28	φ30	φ32	φ36	φ40
<b>Non-cracked concrete</b>													
Tensile N <sub>rec</sub> [kN]	8,2	11,5	16,9	20,6	23,4	37,1	50,9	62,2	74,2	74,2	86,9	100	114
Shear V <sub>rec</sub> [kN]	6,7	10,5	14,8	20,0	26,2	41,0	64,3	69,5	80,5	92,4	105	133	165
<b>Cracked concrete</b>													
Tensile N <sub>rec</sub> [kN]	-	4,3	6,3	7,5	8,5	12,7	19,6	20,0	24,2	26,0	30,8	38,1	46,2
Shear V <sub>rec</sub> [kN]	-	10,5	14,8	20,0	23,9	35,6	55,0	56,0	67,9	72,7	86,2	107	129

a) With overall partial safety factor for action  $\gamma=1,4$ . The partial safety factors for action depend on the type of loading and shall be taken from national regulations.

**Materials**
**Mechanical properties**

Anchor size	φ8	φ10	φ12	φ14	φ16	φ20	φ25	φ26	φ28	φ30	φ32
Nominal tensile strength f <sub>uk</sub> [N/mm <sup>2</sup> ]	550	550	550	550	550	550	550	550	550	550	550
Yield strength f <sub>yk</sub> [N/mm <sup>2</sup> ]	500	500	500	500	500	500	500	500	500	500	500
Stressed cross- section A <sub>s</sub> [mm <sup>2</sup> ]	50,3	78,5	113,1	153,9	201,1	314,2	490,9	531	615,8	707	804,2
Moment of resistance W [mm <sup>3</sup> ]	50,3	98,2	169,6	269,4	402,1	785,4	1534	1726	2155	2651	3217

**Material quality**

Part	Material
Rebar EN 1992-1-1:2004	Bars and de-coiled rods class B or C With f <sub>yk</sub> and k according to NDP or NCL of EN 1992-1-1/NA f <sub>uk</sub> = f <sub>tk</sub> = k · f <sub>yk</sub>

**Setting information**
**Installation temperature**

+ 5°C to + 40°C

**Service temperature range**

Hilti HIT-RE 100-HC injection mortar may be applied in the temperature ranges given below, An elevated base material temperature may lead to a reduction of the design bond resistance,

Temperature range	Base material temperature	Max, long term base material temperature	Max, short term base material temperature
Temperature range I	-40 °C to + 40 °C	+ 24 °C	+ 40 °C
Temperature range II	-40 °C to + 58 °C	+ 35 °C	+ 58 °C
Temperature range III	-40 °C to + 70 °C	+ 43 °C	+ 70 °C

**Max, short term base material temperature**

Short term elevated base material temperatures are those that occur over brief intervals, e.g, as a result of diurnal cycling,

**Max, long term base material temperature**

Long term elevated base material temperatures are roughly constant over significant periods of time,

**Working time and curing time**

Temperature of the base material	Max, working time in which rebar can be inserted and adjusted $t_{work}$	Min, curing time before rebar can be fully loaded $t_{cure}$
$5\text{ °C} \leq T_{BM} < 10\text{ °C}$	2,5 h	72 h
$10\text{ °C} \leq T_{BM} < 15\text{ °C}$	2 h	48 h
$15\text{ °C} \leq T_{BM} < 20\text{ °C}$	1 h	24 h
$20\text{ °C} \leq T_{BM} < 30\text{ °C}$	40 min	18 h
$30\text{ °C} \leq T_{BM} \leq 40\text{ °C}$	20 min	6 h

The curing time data are valid for dry base material only, In wet base material the curing times must be doubled,

**Setting details**

Anchor size		Ø8	Ø10	Ø12	Ø14	Ø16	Ø20	Ø25	Ø26	Ø28	Ø30	Ø32	
Nominal diameter of drill bit	$d_0$ [mm]	10 / 12 <sup>a)</sup>	12 / 14 <sup>a)</sup>	14 <sup>a)</sup>	16 <sup>a)</sup>	18	20	25 / 24 <sup>a)</sup>	32 / 30 <sup>a)</sup>	32	35	37	40
Effective anchorage and drill hole depth range <sup>b)</sup>	$h_{ef,min}$ [mm]	60	60	70	70	75	80	90	100	104	112	120	128
	$h_{ef,max}$ [mm]	160	200	240	240	280	320	400	500	520	560	600	640
Minimum base material thickness	$h_{min}$ [mm]	$h_{ef} + 30\text{ mm} \geq 100\text{ mm}$				$h_{ef} + 2\text{ }d_0$							
Minimum spacing	$s_{min}$ [mm]	40	50	60	60	70	80	100	125	130	140	150	160
Minimum edge distance	$c_{min}$ [mm]	40	45	45	45	50	50	65	70	75	75	80	80
Critical spacing for splitting failure	$s_{cr,sp}$ [mm]	$2\text{ }C_{cr,sp}$											
Critical edge distance for splitting failure <sup>c)</sup>	$c_{cr,sp}$ [mm]	$1,0 \cdot h_{ef}$				for $h / h_{ef} \geq 2,0$							
		$4,6\text{ }h_{ef} - 1,8\text{ }h$				for $2,0 > h / h_{ef} > 1,3$							
		$2,26\text{ }h_{ef}$				for $h / h_{ef} \leq 1,3$							
Critical spacing for concrete cone failure	$s_{cr,N}$ [mm]	$2\text{ }C_{cr,N}$											
Critical edge distance for concrete cone failure <sup>d)</sup>	$c_{cr,N}$ [mm]	$1,5\text{ }h_{ef}$											

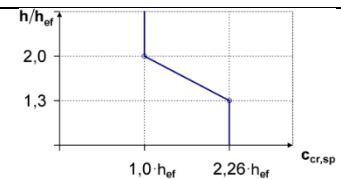

For spacing (edge distance) smaller than critical spacing (critical edge distance) the design loads have to be reduced,

a) Both given values for drill bit diameter can be used

b)  $h_{ef,min} \leq h_{ef} \leq h_{ef,max}$  ( $h_{ef}$ : embedment depth)

c)  $h$ : base material thickness ( $h \geq h_{min}$ )



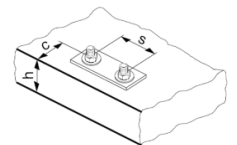

d) The critical edge distance for concrete cone failure depends on the embedment depth  $h_{ef}$  and the design bond resistance, The simplified formula given in this table is on the save side,



**Installation equipment**

Anchor size	φ8	φ10	φ12	φ14	φ16	φ20	φ25	φ26	φ28	φ30	φ32
Rotary hammer	TE 2– TE 16					TE 40 – TE 80					
Other tools	Compressed air gun or blow out pump Set of cleaning brushes, dispenser, piston plug										

**Drilling and cleaning parameters**

Rebar [mm]	Drill bit diameters $d_0$ [mm]		Installation size [mm]	
	Hammer drill (HD)	Hollow Drill Bit (HDB)	Brush HIT-RB	Piston plug HIT-SZ
				
φ8	10 / 12 <sup>a)</sup>	12	10 / 12 <sup>a)</sup>	12
φ10	12 / 14 <sup>a)</sup>	12 / 14 <sup>a)</sup>	12 / 14 <sup>a)</sup>	12 / 14 <sup>a)</sup>
φ12	14 / 16 <sup>a)</sup>	14 / 16 <sup>a)</sup>	14 / 16 <sup>a)</sup>	14 / 16 <sup>a)</sup>
φ14	18	18	18	18
φ16	20	20	20	20
φ20	24 / 25 <sup>a)</sup>	24 / 25 <sup>a)</sup>	24 / 25 <sup>a)</sup>	24 / 25 <sup>a)</sup>
φ25	30 / 32 <sup>a)</sup>	32	30 / 32 <sup>a)</sup>	30 / 32 <sup>a)</sup>
φ26	32	32	32	32
φ28	35	35	35	35
φ30	37	-	37	37
φ32	40	-	40	40

a) Both of the two given values can be used

**Setting instructions**

\*For detailed information on installation see instruction for use given with the package of the product,

**Safety regulations,**

Review the Material Safety Data Sheet (MSDS) before use for proper and safe handling! Wear well-fitting protective goggles and protective gloves when working with Hilti HIT-RE 100-HC.

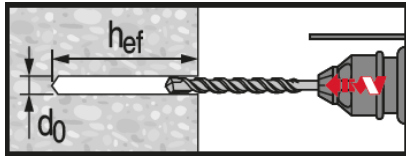
**Hammer drilled hole**

For dry and wet concrete,

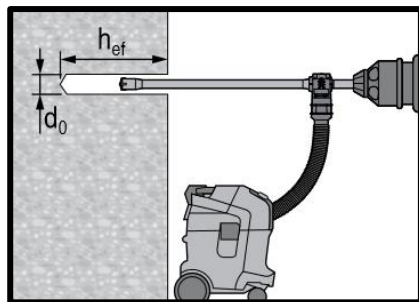
**Hammer drilled hole with Hollow Drilled Bit (HDB)**

No cleaning required,

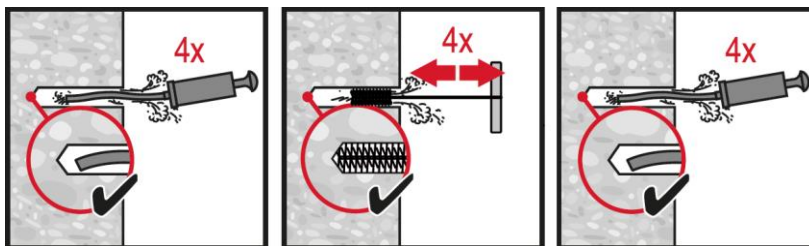
**Manual cleaning (MC)  
Non-cracked concrete only**

for drill diameters  $d_0 \leq 20$  mm and drill hole depth  $h_0 \leq 10 \cdot d$ ,

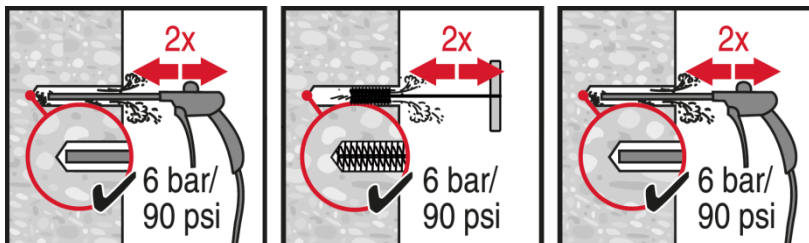

**Hammer Drilling:**
**Compressed air cleaning (CAC)**

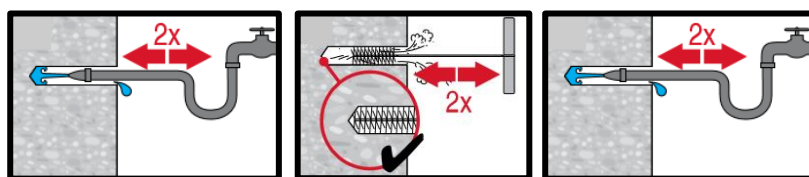
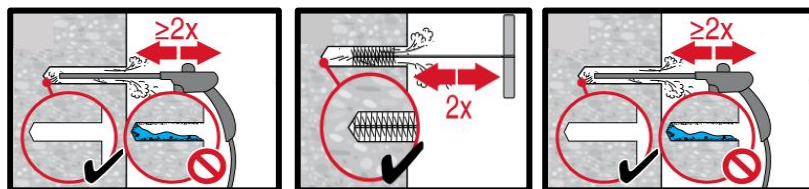
for all drill hole diameters  $d_0$  and drill hole depths  $h_0 \leq 20 \cdot d$ ,

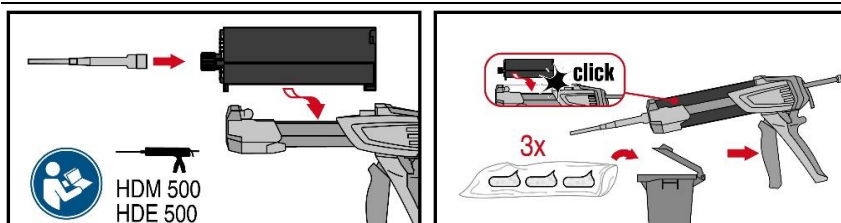

**Compressed air cleaning (CAC)  
cleaning of water-filled holes**

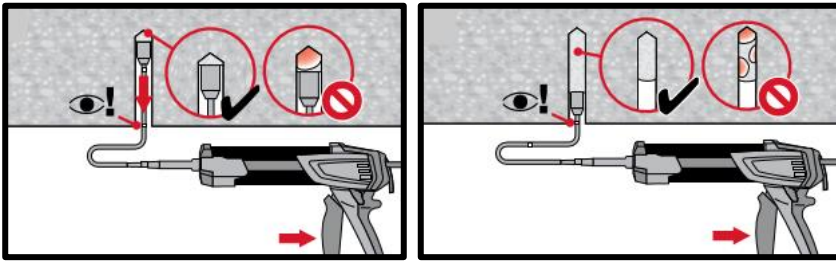
for all drill hole diameters  $d_0$  and drill hole depths  $h_0$ ,



**Injection system preparation,**

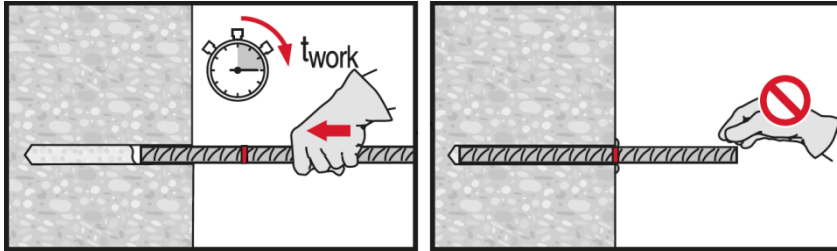

**Injection** method for overhead application and/or installation with embedment depth  $h_{ef} \leq 250$  mm

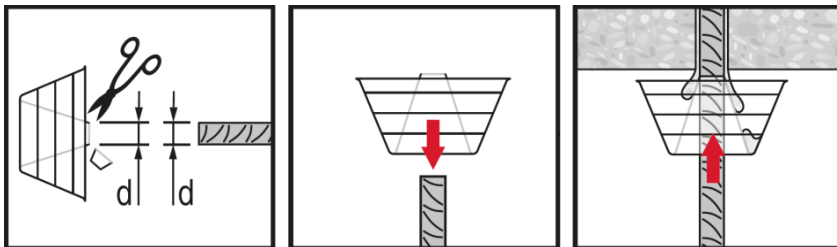

**Setting element**, observe working time "t<sub>work</sub>",



**Setting element** for overhead applications, observe working time "t<sub>work</sub>",

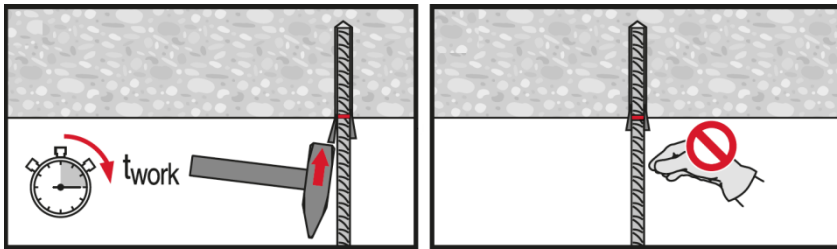

# HIT-RE 100-HC injection mortar

Rebar design (EOTA TR023) / Rebar elements / Concrete

## Injection mortar system



Hilti HIT-RE 100-HC  
580 ml hard cartridge



Rebar B500 B  
(φ8 - φ40)

## Benefits

- Suitable for concrete C 12/15 to C 50/60
- High loading capacity
- Suitable for dry and water saturated concrete
- For rebar diameters up to 40 mm
- Non corrosive to rebar elements
- Long working time at elevated temperatures
- Suitable for embedment length till 3200 mm

## Base material



Concrete  
(uncracked)

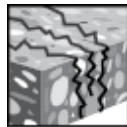

Concrete  
(cracked)



Dry concrete

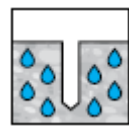

Wet concrete

## Load conditions

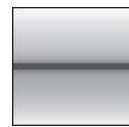

Static/  
quasi-static



Fire  
resistance

## Installation conditions

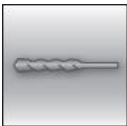

Hammer  
drilling

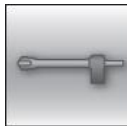

Hollow drill-  
bit drilling



Diamond  
coring

## Other information



European  
Technical  
Assessment



CE  
conformity

## Approvals / certificates

Description	Authority / Laboratory	No. / date of issue
European technical assessment <sup>a)</sup>	DIBt, Berlin	ETA-19/0149 / 2019-12-10

a) All data given in this section according to ETA-19/0149, issue 2019-12-10.

**Basic design data**
**Static EC2 design**
**Design bond strength in N/mm<sup>2</sup> according to ETA-19/0149 for good bond conditions**

Rebar-size	Concrete class								
	C12/15	C16/20	C20/25	C25/30	C30/37	C35/45	C40/50	C45/55	C50/60
<b>All allowed hammer drilling methods</b>									
φ8 - φ32	1,6	2,0	2,3	2,7	3,0	3,4	3,7	4,0	4,3
φ34	1,6	2,0	2,3	2,6	2,9	3,3	3,6	3,9	4,2
φ36	1,5	1,9	2,2	2,6	2,9	3,3	3,6	3,8	4,1
φ40	1,5	1,8	2,1	2,5	2,8	3,1	3,4	3,7	4,0
<b>Diamond coring wet</b>									
φ8 - φ32	1,6	2,0	2,3	2,7					
φ34	1,6	2,0	2,3	2,6					
φ36	1,5	1,9	2,2	2,6					
φ40	1,5	1,8	2,1	2,5					

For poor bond conditions multiply the values by 0,7, Values valid for non-cracked and cracked concrete

**Minimum anchorage length and minimum lap length**

 The minimum anchorage length  $l_{b,min}$  and the minimum overlap length  $l_{0,min}$  according to EN 1992-1-1 shall be multiplied by the relevant **Amplification factor** in the table below,

**Amplification factor  $\alpha_{lb}$  for the min, anchorage length and min, lap length according to EN 1992-1-1 for:**

Rebar - size	Concrete class								
	C12/15	C16/20	C20/25	C25/30	C30/37	C35/45	C40/50	C45/55	C50/60
<b>All allowed hammer drilling methods</b>									
φ8 - φ40	1,0								
<b>Diamond coring dry and wet</b>									
φ8 - φ40	1,5								

**Pre-calculated values<sup>1)</sup> – anchorage length**

 Rebar yield strength  $f_{yk}=500$  N/mm<sup>2</sup>, concrete C25/30, good bond conditions

Rebar-size	Anchorage length	Design value	Mortar volume <sup>2)</sup>	Anchorage length	Design value	Mortar volume <sup>2)</sup>	
	$l_{bd}$ [mm]	$N_{Rd}$ [KN]	$V_M$ [ml]		$l_{bd}$ [mm]	$N_{Rd}$ [KN]	$V_M$ [ml]
$\alpha_1=\alpha_2=\alpha_3=\alpha_4=\alpha_5=1,0$							
φ8	100	6,8	8	φ8	9,7	8	
	170	11,5	13		13,6	11	
	250	17,0	19		17,4	14	
	<b>322,1</b>	21,9	24		<b>225,4</b>	21,9	17
φ10	121	10,3	11	φ10	14,7	11	
	220	18,7	20		20,6	15	
	310	26,3	28		27,9	21	
	<b>402,6</b>	34,1	36		<b>281,8</b>	34,1	25
φ12	145	14,8	15	φ12	21,1	15	
	260	26,5	27		30,5	22	
	370	37,7	39		39,3	29	
	<b>483,1</b>	49,2	51		<b>338,2</b>	49,2	36
φ14	169	20,1	20	φ14	28,7	20	
	300	35,6	36		40,7	29	
	430	51,1	52		54,3	39	
	<b>563,6</b>	66,9	68		<b>394,5</b>	66,9	48



**Pre-calculated values<sup>1)</sup> – anchorage length**

 Rebar yield strength  $f_{yk}=500 \text{ N/mm}^2$ , concrete C25/30, good bond conditions

Rebar-size	Anchorage length	Design value	Mortar volume <sup>2)</sup>	Anchorage length	Design value	Mortar volume <sup>2)</sup>
	$l_{bd}$ [mm]	$N_{Rd}$ [KN]	$V_M$ [ml]		$l_{bd}$ [mm]	$N_{Rd}$ [KN]
	$\alpha_1=\alpha_2=\alpha_3=\alpha_4=\alpha_5=1,0$			$\alpha_1=\alpha_3=\alpha_4=1,0 \quad \alpha_2 \text{ or } \alpha_5=0,7$		
φ16	193	26,2	26	193	37,4	26
	340	46,1	46	280	54,3	38
	490	66,5	67	370	71,7	50
	<b>644</b>	87,4	87	<b>450,9</b>	87,4	61
φ18	217	33,1	33	217	47,3	33
	380	58	57	310	67,6	47
	540	82,4	81	410	89,4	62
	<b>724,6</b>	110,6	109	<b>507,2</b>	110,6	76
φ20	242	41,1	51	242	58,6	51
	390	66,2	83	350	84,8	74
	550	93,3	117	460	111,5	98
	<b>805,2</b>	136,6	171	<b>563,6</b>	136,6	120
φ22	266	49,6	75	266	70,9	75
	410	76,5	116	380	101,3	107
	560	104,5	158	500	133,3	141
	<b>885,7</b>	165,3	250	<b>620</b>	165,3	175
φ24	290	59	122	290	84,3	122
	430	87,5	182	420	122,1	177
	560	114	236	550	160	232
	<b>966,2</b>	196,7	408	<b>676,3</b>	196,7	286
φ25	302	64	114	302	91,5	114
	430	91,2	162	430	130,3	162
	570	120,9	214	570	172,7	214
	<b>1006,4</b>	213,4	378	<b>704,5</b>	213,4	265
φ28	350	83,1	145	338	114,7	140
	595	141,3	247	480	162,9	200
	875	207,8	364	635	215,5	264
	<b>1127,2</b>	267,7	469	<b>789</b>	267,7	328
φ30	374	95,2	165	374	136	165
	635	161,6	281	528	191,9	233
	935	237,9	413	700	254,5	309
	<b>1207,7</b>	307,3	534	<b>845,4</b>	307,3	374
φ32	400	108,6	217	400	155,1	217
	680	184,6	369	580	224,9	315
	1000	271,4	543	800	310,2	434
	<b>1288,2</b>	349,7	699	<b>901,8</b>	349,7	490
φ36	450	132,3	387	440	184,8	379
	765	225	658	640	268,8	551
	1125	330,8	968	900	378,1	774
	<b>1505,0</b>	442,6	1295	<b>1053,5</b>	442,6	907
φ40	500	157,1	520	485	217,7	505
	850	267	884	700	314,2	728
	1000	314,2	1040	990	444,3	1030
	<b>1739,1</b>	546,4	1810	<b>1217,4</b>	546,4	1267

1) Values corresponding to the minimum anchorage length, The maximum permissible load is valid for "good bond conditions" as described in EN 1992-1-1, For all other conditions multiply by the value by 0,7,

 2) The volume of mortar corresponds to the formula  $1,2 \cdot (d_o^2 - d_s^2) \cdot \pi \cdot l_b / 4$  for hammer drilling

**Pre-calculated values – overlap length**

 Rebar yield strength  $f_{yk}=500 \text{ N/mm}^2$ , concrete c25/30, good bond conditions

Rebar-size	Overlap length	Design value	Mortar volume <sup>2)</sup>	Overlap length	Design value	Mortar volume <sup>2)</sup>
	$l_0$ [mm]	$N_{Rd}$ [KN]	$V_M$ [ml]		$l_0$ [mm]	$N_{Rd}$ [KN]
	$\alpha_1=\alpha_2=\alpha_3=\alpha_4=\alpha_5=1,0$			$\alpha_1=\alpha_3=\alpha_4=1,0 \quad \alpha_2 \text{ or } \alpha_5=0,7$		
$\phi 8$	200	13,6	15	200	19,4	15
	240	16,3	18	210	20,4	16
	280	19	21	220	21,3	17
	<b>322,1</b>	21,9	24	<b>225,4</b>	21,9	17
$\phi 10$	200	17	18	200	24,2	18
	270	22,9	24	230	27,9	21
	340	28,8	31	250	30,3	23
	<b>402,6</b>	34,1	36	<b>281,8</b>	34,1	25
$\phi 12$	200	20,4	21	200	29,1	21
	290	29,5	31	250	36,4	26
	390	39,7	41	290	42,2	31
	<b>483,1</b>	49,2	51	<b>338,2</b>	49,2	36
$\phi 14$	210	24,9	25	210	35,6	25
	330	39,2	40	270	45,8	33
	450	53,4	54	330	56	40
	<b>563,6</b>	66,9	68	<b>394,5</b>	66,9	48
$\phi 16$	240	32,6	33	240	46,5	33
	370	50,2	50	310	60,1	42
	510	69,2	69	380	73,7	52
	<b>644</b>	87,4	87	<b>450,9</b>	87,4	61
$\phi 18$	270	41,2	41	270	58,9	41
	410	62,6	62	350	76,3	53
	560	85,5	84	430	93,8	65
	<b>724,6</b>	110,6	109	<b>507,2</b>	110,6	76
$\phi 20$	300	50,9	64	300	72,7	64
	430	72,9	91	390	94,5	83
	570	96,7	121	480	116,3	102
	<b>805,2</b>	136,6	171	<b>563,6</b>	136,6	120
$\phi 22$	330	61,6	93	330	88	93
	450	84	127	430	114,6	122
	580	108,2	164	520	138,6	147
	<b>885,7</b>	165,3	250	<b>620</b>	165,3	175
$\phi 24$	360	73,3	152	360	104,7	152
	470	95,7	198	470	136,7	198
	590	120,1	249	570	165,8	241
	<b>966,2</b>	196,7	408	<b>676,3</b>	196,7	286
$\phi 25$	375	79,5	141	375	113,6	141
	430	91,2	162	480	145,4	181
	570	120,9	214	590	178,7	222
	<b>1006,4</b>	213,4	378	<b>704,5</b>	213,4	265
$\phi 28$	420	99,8	175	420	142,5	175
	595	141,3	247	530	179,8	220
	875	207,8	364	635	215,5	264
	<b>1127,2</b>	267,7	469	<b>789</b>	267,7	328

### Pre-calculated values – overlap length

Rebar yield strength  $f_{yk}=500 \text{ N/mm}^2$ , concrete c25/30, good bond conditions

Rebar-size	Overlap length	Design value	Mortar volume <sup>2)</sup>		Overlap length	Design value	Mortar volume <sup>2)</sup>
	$l_0$ [mm]	$N_{Rd}$ [KN]	$V_M$ [ml]		$l_0$ [mm]	$N_{Rd}$ [KN]	$V_M$ [ml]
	$\alpha_1=\alpha_2=\alpha_3=\alpha_4=\alpha_5=1,0$				$\alpha_1=\alpha_3=\alpha_4=1,0 \quad \alpha_2 \text{ or } \alpha_5=0,7$		
$\phi 30$	450	114,5	199		450	163,6	199
	635	161,6	281		528	191,9	233
	935	237,9	413		700	254,5	309
	<b>1207,7</b>	<b>307,3</b>	<b>534</b>		<b>845,4</b>	<b>307,3</b>	<b>374</b>
$\phi 32$	480	130,3	261		480	186,1	261
	680	184,6	369		650	252	353
	1000	271,4	543		800	310,2	434
	<b>1288,2</b>	<b>349,7</b>	<b>699</b>		<b>901,8</b>	<b>349,7</b>	<b>490</b>
$\phi 36$	540	158,8	465		540	218,1	465
	765	225,0	658		720	290,0	620
	1125	330,8	968		900	363,5	774
	<b>1505,0</b>	<b>442,6</b>	<b>1295</b>		<b>1053,5</b>	<b>442,6</b>	<b>907</b>
$\phi 40$	600	188,5	624		600	269,3	624
	850	267,0	884		750	336,6	780
	1000	314,2	1040		990	444,3	1030
	<b>1739,1</b>	<b>505,9</b>	<b>1676</b>		<b>1217,4</b>	<b>546,4</b>	<b>1267</b>

- 1) Values corresponding to the minimum anchorage length. The maximum permissible load is valid for "good bond conditions" as described in EN 1992-1-1. For all other conditions multiply by the value by 0,7.  
 2) The volume of mortar corresponds to the formula " $1,2 \cdot (d_o^2 - d_s^2) \cdot \pi \cdot l_b / 4$ " for hammer drilling

### Fire resistance

The design method consists of four steps. First, determining a reduction factor  $KN(\theta)$ , which describes the proportion between bond resistance and temperature, based on pullout tests at various temperatures. Secondly, a thermal simulation using the Finite Elements method is carried out to determine the temperature figure along the rebar at certain time T during a fire. Thirdly, the bond resistances in case of fire are estimated using the first two steps. A fourth step, in case of the beam-wall connection, is the calculation of the characteristic maximal load by integration of the bond resistance. Thermal simulations, geometrics considerations and safety co-efficients are determined in accordance with Eurocode and standards.

#### Step 1

Reduction factor  $KN(\theta)$

#### Step 2

Finite Element simulation: Temperature profile for each rebar diameter and anchorage length along the bonding interface in relation to the fire exposure duration T.

#### Step 3

Slab-slab connection:  $TR_k$  along the bonding interface

#### Step 4

Characteristic maximal load

$$F_{bk} = \emptyset \cdot \pi \cdot \int_0^L \tau_{Rk} \cdot (T(x)) \cdot dx$$

Where:

- $\tau_{Rk}$ : the characteristic bonding resistance [N/mm<sup>2</sup>].
- T: the temperature [°].
- $F_{bk}$ : the characteristic maximum load applicable to the rebar at a given time [N].
- L: the embedment length [mm].
- $\emptyset$ : the rebar diameter [mm].

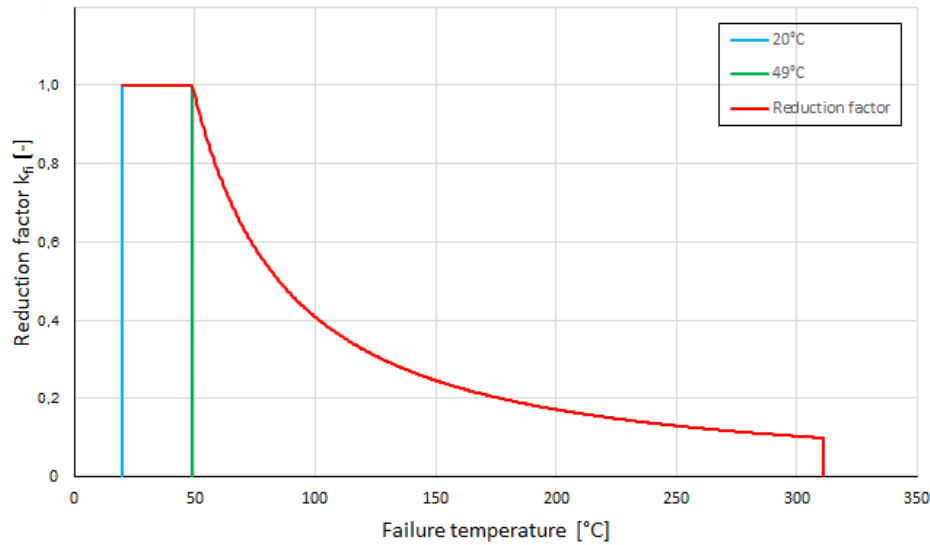

Relationship between temperature and the reduction factor

$$\begin{aligned}
 20^{\circ}\text{C} \leq \theta \leq 49^{\circ}\text{C} & \quad k_N = 1 \\
 50^{\circ}\text{C} \leq \theta \leq 311^{\circ}\text{C} & \quad k_N = \frac{1285,7 * \ominus^{-1,249}}{10} \\
 \theta > 311^{\circ}\text{C} & \quad k_N = 0
 \end{aligned}$$

This report uses the characteristic values of bond strength. Accordingly, the values of bond resistance and load resistance in case of fire are given as characteristic values

### a) Anchoring application

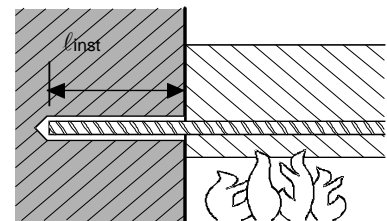

Anchoring application beam-wall connections with a concrete cover of 20 mm

Maximum force ( $F_{s,T,max}$ ) in rebar in conjunction with HIT-RE 100-HC as a function of embedment depth ( $l_{inst}$ ) for the fire resistance classes F30 to F240 according to EC2.

Rebar-size	$F_{s,T,max}$ [kN]	$l_{inst}$ [mm]	Fire resistance of bar [kN]					
			R30	R60	R90	R120	R180	R240
$\phi 8$	16,8	100	3,9	1,6	0,9	0,6	0,3	0,1
		110	4,6	1,9	1,1	0,7	0,4	0,1
		140	7,4	4,3	2,6	1,7	1,0	0,6
		160	9,1	6,1	4,0	2,7	1,6	1,0
		260	17,8	14,8	12,6	10,9	8,0	5,6
		290	20,4	17,4	15,2	13,5	10,6	8,0
		310	22,1	19,1	16,9	15,2	12,4	9,9
		330	23,8	20,8	18,7	16,9	14,1	11,6
		370	25,1	24,3	22,1	20,4	17,6	15,1
		400		25,1	24,7	23,0	20,2	17,7
$\phi 10$	26,2	110	5,6	2,3	1,3	0,8	0,5	0,1
		140	9,1	5,1	3,0	2,1	1,3	0,8
		160	11,3	7,3	4,6	3,2	1,9	1,2
		260	22,1	18,1	15,4	13,2	9,7	6,7
		290	25,4	21,4	18,6	16,4	13,0	9,6
		310	27,6	23,6	20,8	18,6	15,1	12,0
		340	30,8	26,8	24,0	21,9	18,4	15,2
		360	33,0	29,0	26,2	24,0	20,5	17,4
		380	35,1	31,1	28,4	26,2	22,7	19,6
		450	39,3	38,7	35,9	33,8	30,3	27,1

Maximum force ( $F_{s,T,max}$ ) in rebar in conjunction with HIT-RE 100-HC as a function of embedment depth ( $l_{inst}$ ) for the fire resistance classes F30 to F240 according to EC2.

Rebar-size	$F_{s,T,max}$ [kN]	$l_{inst}$ [mm]	Fire resistance of bar [kN]					
			R30	R60	R90	R120	R180	R240
$\phi 12$	37,7	110	6,5	2,6	1,5	0,9	0,6	0,1
		140	10,7	5,8	3,4	2,4	1,4	0,9
		160	13,3	8,4	5,2	3,6	2,2	1,4
		260	26,4	21,4	18,0	15,4	11,1	7,7
		360	39,4	34,4	31,0	28,4	24,1	20,4
		390	43,3	38,3	34,9	32,3	28,0	24,3
		450	51,1	46,1	42,7	40,1	35,8	32,1
		500	56,5	52,6	49,2	46,6	42,3	38,6
$\phi 14$	51,3	160	15,5	9,3	5,8	4,0	2,5	1,6
		260	30,6	24,5	20,6	17,3	12,3	8,5
		360	45,8	39,7	35,7	32,5	27,4	23,1
		400	51,9	45,7	41,8	38,6	33,5	29,2
		450	59,5	53,3	49,4	46,2	41,1	36,8
		500	67,1	60,9	57,0	53,8	48,7	44,4
		550	74,6	68,5	64,6	61,3	56,3	51,9
		600	82,1	76,0	72,1	68,8	64,5	60,2
$\phi 16$	67,0	180	21,0	13,6	9,0	6,4	4,0	2,7
		260	34,8	27,4	22,8	19,2	13,4	9,3
		360	52,2	44,8	40,1	36,5	30,7	25,7
		460	69,5	62,1	57,5	53,9	48,1	43,0
		500	76,4	69,1	64,4	60,8	55,0	49,9
		560	86,8	79,5	74,8	71,2	65,4	60,3
		600	93,8	86,4	81,7	78,1	72,3	67,3
		650	100,8	93,4	88,7	85,1	79,3	74,3
$\phi 20$	104,7	220	34,3	24,6	18,4	13,4	8,2	6,1
		260	43,0	33,2	27,0	21,9	14,7	10,6
		360	64,7	54,9	48,7	43,6	36,2	30,3
		550	108,0	98,3	92,1	86,9	79,5	73,6
		600	116,7	106,9	100,7	95,6	88,2	82,3
		650	129,7	119,9	113,8	108,6	101,2	95,3
		700	138,4	128,6	122,4	117,3	109,9	104,0

\*For additional values please check GS 3,2/15-431-4 fire report,  
Characteristic yield strength  $f_{yk} = 500 \text{ N/mm}^2$

### b) Overlap joint application

Max, bond stress,  $f_{bd,FIRE}$ , depending on actual clear concrete cover for classifying the fire resistance,

It must be verified that the actual force in the bar during a fire,  $F_{s,T}$ , can be taken up by the bar connection of the selected length,  $l_{inst}$ , Note: Cold design for ULS is mandatory,

$$F_{s,T} \leq (l_{inst} - c_f) \cdot \phi \cdot \pi \cdot f_{bd,FIRE} \quad \text{where: } (l_{inst} - c_f) \geq l_s;$$

$l_s$  = lap length

$\phi$  = nominal diameter of bar

$l_{inst} - c_f$  = selected overlap joint length; this must be at least  $l_s$ ,

but may not be assumed to be more than  $80 \phi$

$f_{bd,FIRE}$  = bond stress when exposed to fire

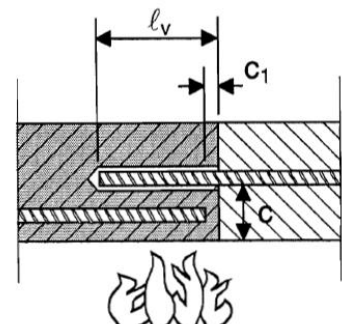

**Critical temperature-dependent bond resistance,  $f_{bk, FIRE}$ , concerning “overlap joint” for Hilti HIT-RE 100-HC injection adhesive in relation to fire resistance class and required minimum concrete coverage  $c$ .**

Concrete cover $c_{nom}$ [mm]	Characteristic bond resistance in case of fire, $f_{bk, fire}$ [N/mm <sup>2</sup> ]							
	R30	R60	R90	R120	R180	R240		
50	1,1	0,4	0,0	0,0	0,0	0,0		
60	1,6	0,6	0,4					
70	2,2	0,8	0,5					
80	3,0	1,1	0,6	0,5	0,4	0,3		
90	3,5	1,4	0,8	0,6				
100		1,8	1,1	0,7			0,5	
110		2,3	1,3	0,9			0,5	
120		2,9	1,6	1,1			0,6	
130		3,5	3,5	2,0			1,3	0,8
140				2,4			1,6	0,9
150				2,8			1,9	1,1
160				3,3			2,2	1,3
170				3,5			3,5	3,5
180					3,0	1,7		
190	1,9				1,3			
200	2,2				1,5			
210	2,5				1,7			
220	2,8				1,9			
230	3,2	2,1						
240	3,5	3,5	3,5		3,5	2,3		
250						2,6		
260						2,8		
270				3,1				
280				3,5				
290	3,5							

## Materials

### Material quality

Part	Material
Rebar EN 1992-1-1	Bars and de-coiled rods class B or C with $f_{yk}$ and $k$ according to NDP or NCL of EN 1992-1-1 $f_{uk} = f_{tk} = k \cdot f_{yk}$

### Fitness for use

Some creep tests have been conducted in accordance with ETAG guideline 001 part 5 and TR 023 in the following conditions: **in dry environment at 50 °C during 90 days**,

These tests show an excellent behaviour of the post-installed connection made with HIT-RE 100-HC: low displacements with long term stability, failure load after exposure above reference load,

### Resistance to chemical substances

Chemical	Resistance	Chemical	Resistance
Acetic acid 100%	o	Methanol 100%	o
Acetic acid 10%	+	Peroxide of hydrogen 30%	o
Hydrochloric Acid 20%	+	Solution of phenol (sat.)	-
Nitric Acid 40%	-	Sodium hydroxide pH=14	+
Phosphoric Acid 40%	+	Solution of chlorine (sat.)	+
Sulphuric acid 40%	+	Solution of hydrocarbons (60 % vol Toluene, 30 % vol Xylene, 10 % vol Methyl naphthalene)	+
Ethyl acetate 100%	o	Salted solution 10% sodium chloride	+
Acetone 100%	-	Suspension of concrete (sat.)	+
Ammoniac 5%	o	Chloroform 100%	+
Diesel 100%	+	Xylene 100%	+
Gasoline 100%	+		
Ethanol 96%	o		
Machine oils 100%	+		

- + resistant
- o resistant in short term (max, 48h) contact
- not resistant

### Electrical Conductivity

HIT-RE 100-HC in the hardened state **is not conductive electrically**, Its electric resistivity is  $1,4 \cdot 10^{10} \Omega \cdot m$  (DIN IEC 93 – 12,93), It is adapted well to realize electrically insulating anchorings (ex: railway applications, subway),

### Installation temperature range:

+5°C to +40°C

### Service temperature range

Hilti HIT-RE 100-HC injection mortar may be applied in the temperature ranges given below, An elevated base material temperature may lead to a reduction of the design bond resistance,

Temperature range	Base material temperature	Maximum long term base material temperature	Maximum short term base material temperature
Temperature range I	-40 °C to +80 °C	+50 °C	+80 °C

### Max short term base material temperature

Short-term elevated base material temperatures are those that occur over brief intervals, e.g, as a result of diurnal cycling,

### Max long term base material temperature

Long-term elevated base material temperatures are roughly constant over significant periods of time,

**Working time and curing time<sup>a)</sup>**

Temperature IN the base material $T_{BM}$	Maximum working time $t_{work}$	Initial curing time $t_{cure,ini}^{b)}$	Minimum curing time $t_{cure}$
$5\text{ °C} \leq T_{BM} < 9\text{ °C}$	2,5 h	18 hours	72 hours
$10\text{ °C} \leq T_{BM} < 14\text{ °C}$	2 h	12 hours	48 hours
$15\text{ °C} \leq T_{BM} < 19\text{ °C}$	1 h	8 hours	24 hours
$20\text{ °C} \leq T_{BM} < 29\text{ °C}$	40 min	6 hours	18 hours
$30\text{ °C} \leq T_{BM} \leq 40\text{ °C}$	20 min	2 hours	6 hours

- a) The curing time data are valid for dry base material only, In wet base material the curing times must be doubled,  
 b) After  $t_{cure,ini}$  has elapsed preparation work may continue

**Setting information**
**Installation equipment**

Rebar – size	$\phi 8\text{--}\phi 16$	$\phi 18\text{--}\phi 40$
Rotary hammer	TE2(-A) – TE30(-A)	TE40 – TE80
Other tools	Blow out pump ( $h_{ef} \leq 10 \cdot d$ )	-
	Compressed air gun <sup>a)</sup> Set of cleaning brushes <sup>b)</sup> , dispenser, piston plug	

- a) Compressed air gun with extension hose for all drill holes deeper than 250 mm (for  $\phi 8$  to  $\phi 12$ ) or deeper than  $20 \cdot \phi$  (for  $\phi > 12$  mm)  
 b) Automatic brushing with round brush for all drill holes deeper than 250 mm (for  $\phi 8$  to  $\phi 12$ ) or deeper than  $20 \cdot \phi$  (for  $\phi > 12$  mm)

**Minimum concrete cover  $c_{min}$  of the post-installed rebar**

Drilling method	Rebar – size [mm]	Minimum concrete cover $c_{min}$ [mm]	
		Without drilling aid	With drilling aid
Hammer drilling (HD) and (HDB) <sup>1)</sup>	$\phi < 25$	$30 + 0,06 \cdot l_v \geq 2 \cdot \phi$	$30 + 0,02 \cdot l_v \geq 2 \cdot \phi$
	$\phi \geq 25$	$40 + 0,06 \cdot l_v \geq 2 \cdot \phi$	$40 + 0,02 \cdot l_v \geq 2 \cdot \phi$
Compressed air drilling (CA)	$\phi < 25$	$50 + 0,08 \cdot l_v$	$50 + 0,02 \cdot l_v$
	$\phi \geq 25$	$60 + 0,08 \cdot l_v \geq 2 \cdot \phi$	$60 + 0,02 \cdot l_v \geq 2 \cdot \phi$
Diamond coring dry (PCC) or wet (DD)	$\phi < 25$	Drill stand is used as drilling aid	$30 + 0,02 \cdot l_v \geq 2 \cdot \phi$
	$\phi \geq 25$		$40 + 0,02 \cdot l_v \geq 2 \cdot \phi$

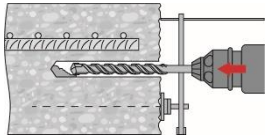









- 1) HDB = hollow drill bit Hilti TE-CD and TE-YD.

**Dispenser and corresponding maximum embedment depth  $l_{v,max}$** 

Dispenser	HDM 500			HDE 500		
Mortar temperature	10-19°C	20-25°C		10-19°C	20-25°C	
Base material temperature	5-20°C	5-20°C	>20°C	5-20°C	5-20°C	>20°C
$\phi$ [mm]	$l_{v,max}$ [mm]					
$\phi 8$ to $\phi 12$	500	1000	1000	500	1000	1000
$\phi 14$					1200	1200
$\phi 16$		1500			1500	
$\phi 18$ to $\phi 20$			1300			1500
$\phi 22$ to $\phi 25$		700	1000			
$\phi 26$ to $\phi 32$		500	700		700	1000
$\phi 34$ to $\phi 40$					500	



**Drilling and cleaning diameters**

Rebar [mm]	Drill bit diameters $d_0$ [mm]			Diamond core $d_0$ [mm]		Installation size [mm]	
	Hammer drill (HD)	Compressed air drill (CA)	Hollow Drill Bit (HDB)	Wet (DD)	Dry (PCC) <sup>b)</sup>	Brush HIT-RB	Air nozzle HIT-DL
							
$\phi 8$	12 (10 <sup>a)</sup> )	-	12	12 (10 <sup>a)</sup> )	-	12 (10 <sup>a)</sup> )	12 (10 <sup>a)</sup> )
$\phi 10$	14 (12 <sup>a)</sup> )	-	14 (12 <sup>a)</sup> )	14 (12 <sup>a)</sup> )	-	14 (12 <sup>a)</sup> )	14 (12 <sup>a)</sup> )
$\phi 12$	16 (14 <sup>a)</sup> )	-	16 (14 <sup>a)</sup> )	16 (14 <sup>a)</sup> )	-	16 (14 <sup>a)</sup> )	16 (14 <sup>a)</sup> )
	-	17	-	-	-	18	16
$\phi 14$	18	17	18	18	-	18	18
$\phi 16$	20	-	20	20	-	20	20
	-	20	-	-	-	22	20
$\phi 18$	22	22	22	22	-	22	22
$\phi 20$	25 (24 <sup>a)</sup> )	-	25	25	-	25 (24 <sup>a)</sup> )	25 (24 <sup>a)</sup> )
	-	26	-	-	-	28	25
$\phi 22$	28	28	28	28	-	28	28
$\phi 24$	32	32	32	32	-	32	32
	-	-	-	-	35	-	
$\phi 25$	32 (30 <sup>a)</sup> )	32 (30 <sup>a)</sup> )	32	32 (30 <sup>a)</sup> )	-	32 (30 <sup>a)</sup> )	
	-	-	-	-	35	-	
$\phi 26$	35	35	-	35	35	35	
$\phi 28$	35	35	-	35	35	35	
$\phi 30$	-	35	-	35	35	35	
	37	-	-	-	-	37	
$\phi 32$	40	40	-	40	47	40	
$\phi 34$	-	42	-	42	47	42	
	45	-	-	-	-	45	
$\phi 36$	45	45	-	-	47	45	
	-	-	-	47	-	47	
$\phi 40$	-	-	-	52	52	52	
	55	57	-	-	-	55	

- a) Both of a given values can be used,  
 b) No cleaning required,

**Setting instructions**

\*For detailed information on installation see instruction for use given with the package of the product,

**Safety regulations,**

Review the Material Safety Data Sheet (MSDS) before use for proper and safe handling! Wear well-fitting protective goggles and protective gloves when working with Hilti HIT-RE 100-HC.

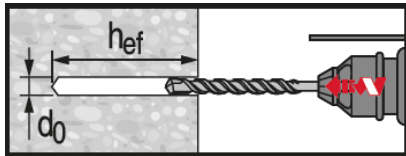
**Hammer drilled hole**

For dry and wet concrete,

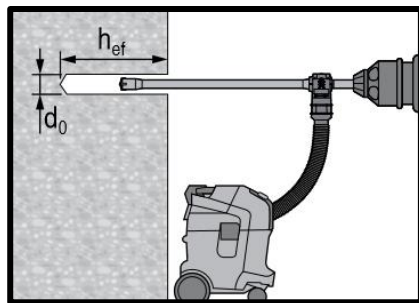
**Hammer drilled hole with Hollow Drilled Bit (HDB)**

No cleaning required,

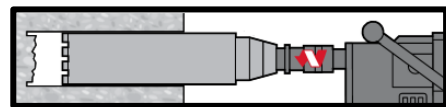
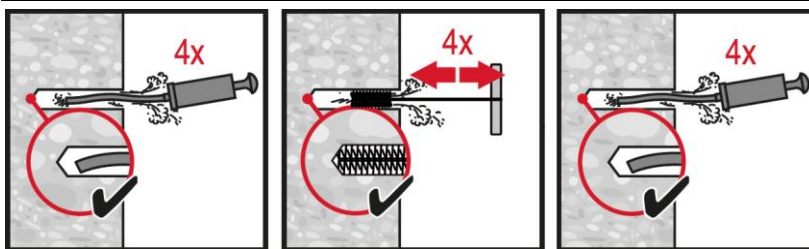
**Diamond Drilling (DD)**

**Hammer Drilling:**
**Manual cleaning (MC)**

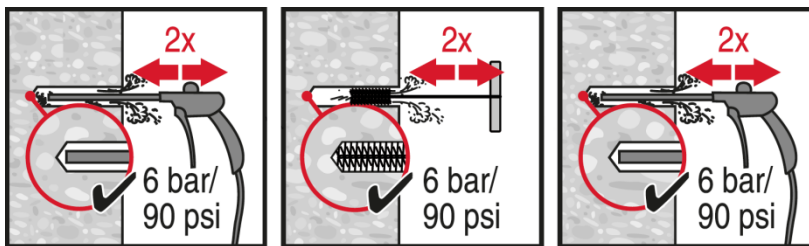
for drill diameters  $d_0 \leq 20$  mm and drill hole depth  $h_0 \leq 10 \cdot d$ ,

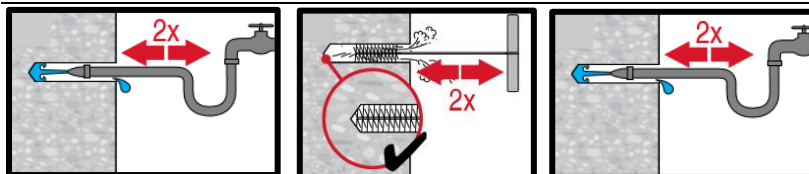

**Hammer Drilling:**
**Compressed air cleaning (CAC)**

for all drill hole diameters  $d_0$  and drill hole depths  $h_0 \leq 20 \cdot d$ ,

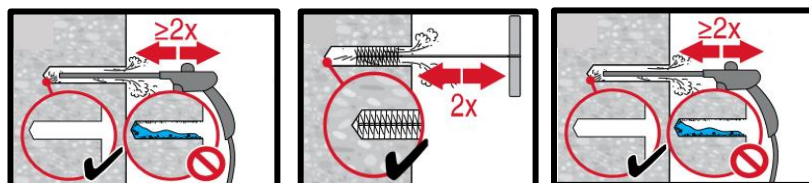

**Wet diamond coring:**
**Compressed air cleaning (CAC)**

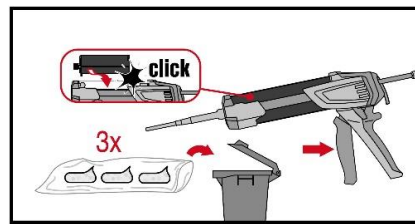
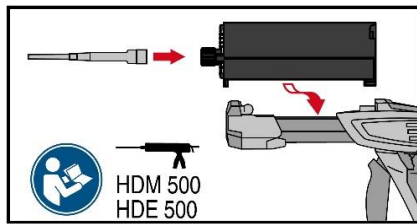
for all drill hole diameters  $d_0$  and drill hole depths  $h_0$ ,



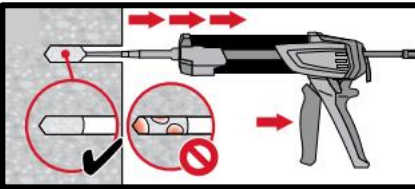
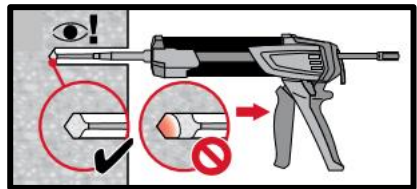

**Injection system preparation,**



**Injection method for drill hole depth**  
 $h_{ef} \leq 250 \text{ mm},$

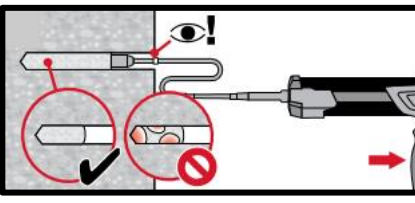
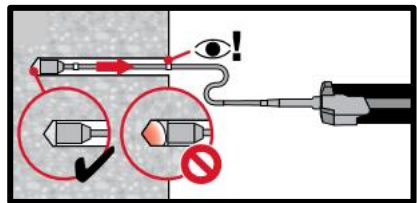

**Injection method for drill hole depth**  
 $h_{ef} > 250 \text{ mm},$

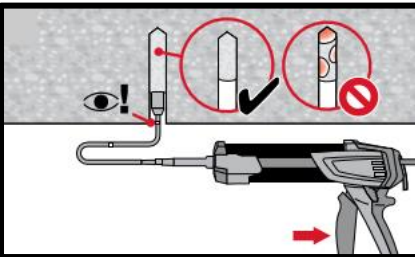
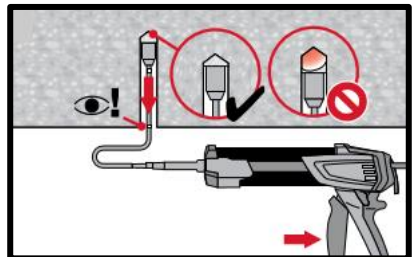

**Injection method for overhead**  
application,

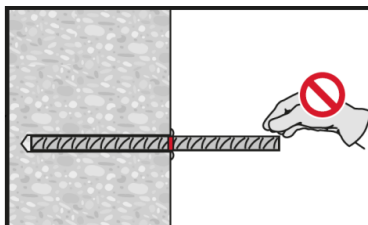
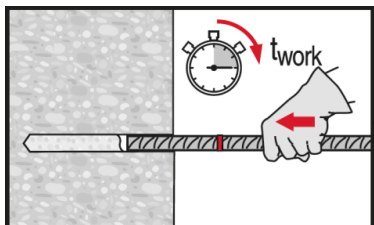

**Setting element, observe working time**  
“ $t_{work}$ ”,

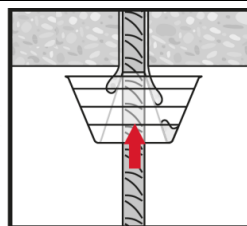
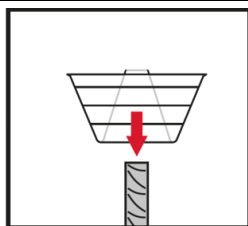
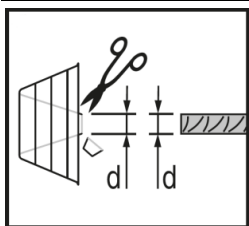

**Setting element for overhead**  
applications, observe working time “ $t_{work}$ ”,

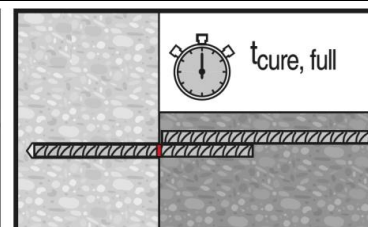
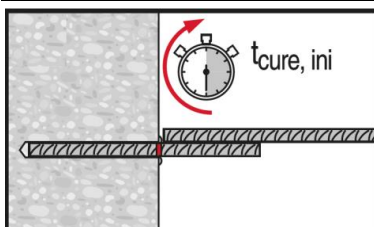
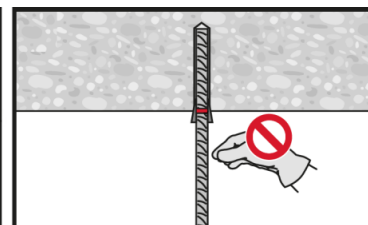
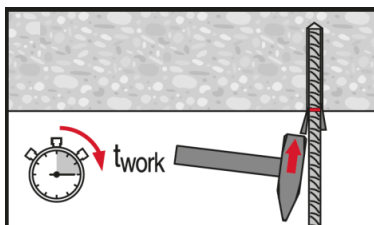

**Apply full load only after curing time**  
“ $t_{cure}$ ”,

## 2.1.8 HIT-CT 1

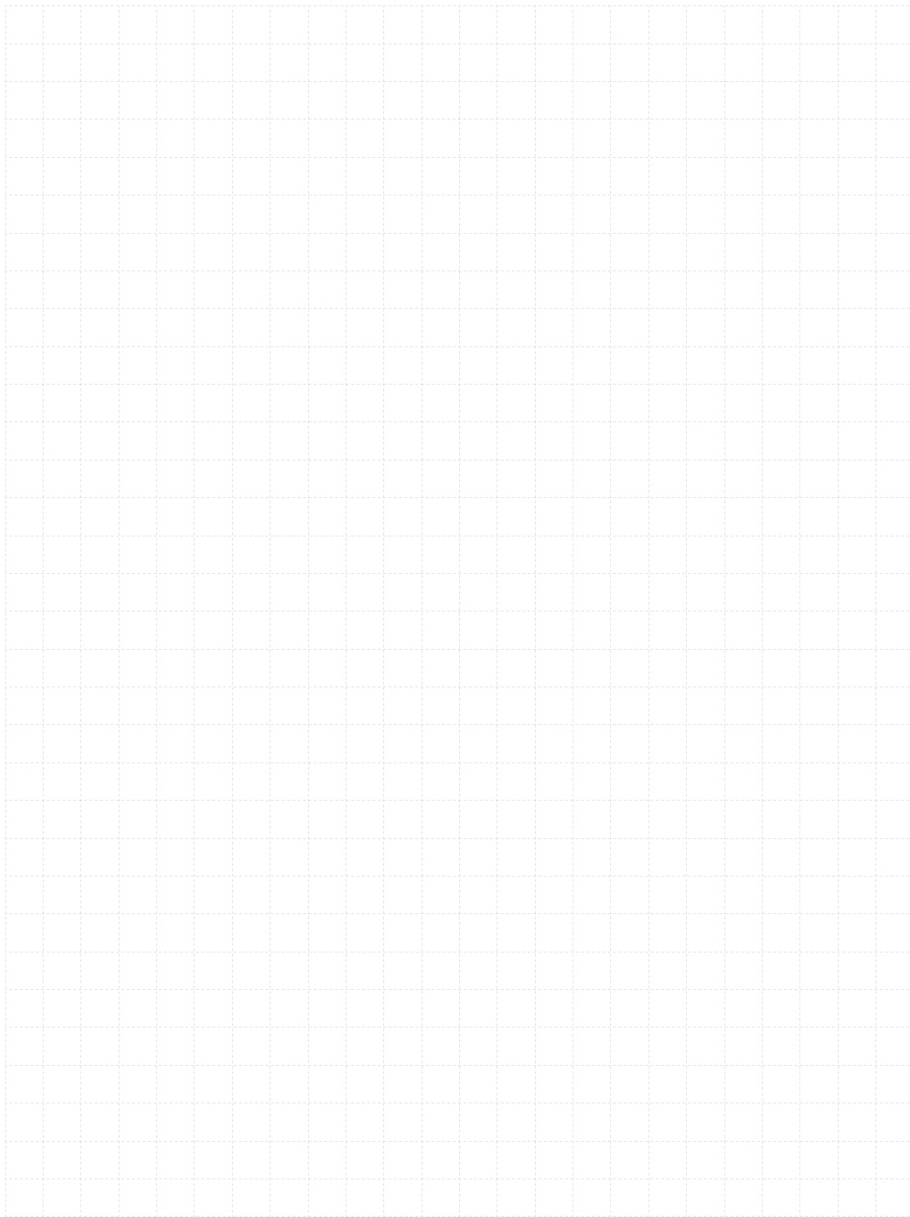

# HIT-CT 1 injection mortar

## Anchor design (EN 1992-4) / Rods / Concrete

### Injection mortar system



Hilti HIT-CT 1  
330 ml foil pack  
(also available as  
500 ml foil pack)

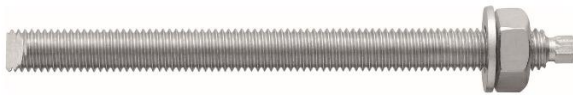

Anchor rods:  
HAS-U  
HAS-U HDG  
HAS-U A4  
HAS-U HCR  
(M8 - M24)

### Benefits

- Suitable for non-cracked and cracked <sup>a)</sup> concrete C 20/25 to C 50/60.
- **SafeSet** technology: Hilti hollow drill bit for hammer drilling
- Suitable for cracked and non-cracked concrete C20/25 to C50/60
- Suitable for dry and water saturated concrete
- High loading capacity and fast curing
- Hybrid chemistry
- Good load capacity at elevated temperatures, and suitable for applications down to -5°C

### Base material



Concrete  
(non-cracked)

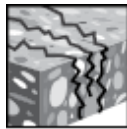

Concrete  
(cracked) <sup>a)</sup>

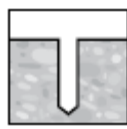

Dry concrete

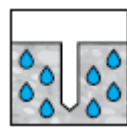

Wet  
concrete

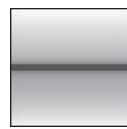

Static/  
quasi-static

### Load condition

### Installation conditions

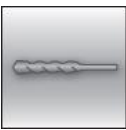

Hammer  
drilling

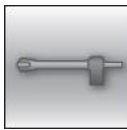

Hollow drill-  
bit drilling

**SAFESET**

Hilti **SafeSet**  
technology

### Other information



European  
Technical  
Assessment



CE  
conformity



PROFIS  
Engineering  
design  
Software

a) Applications with anchor rods HAS-U M10-M16

### Approvals / certificates

Description	Authority / Laboratory	No. / date of issue
European technical assessment <sup>a)</sup>	CSTB, Marne la Vallée	ETA-11/0354 / 2020-09-01

a) All data given in this section according to ETA-11/0354 issue 2020-09-01.

## Static and quasi-static loading (for a single anchor)

### All data in this section applies to

- Correct setting (see setting instruction)
- No edge distance and spacing influence
- Steel failure
- Base material thickness, as specified in the table
- Embedment depth, as specified in the table
- Anchor material, as specified in the tables
- Concrete C 20/25
- In-service temperate range I

(min. base material temperature -40°C, max. long term/short term base material temperature: +24°C/40°C)

### Embedment depth and base material thickness

Anchor- size			M8	M10	M12	M16	M20	M24
Embedment depth <sup>a)</sup>	$h_{ef}$	[mm]	80	90	110	130	170	210
Base material thickness	$h_{min}$	[mm]	110	120	140	160	220	270

a) The allowed range of embedment depth is shown in the setting details

### For hammer drilled holes and Hilti hollow drill bit <sup>a)</sup> :

#### Characteristic resistance

Anchor size				M8	M10	M12	M16	M20	M24
<b>Non-cracked concrete</b>									
Tension	HAS-U 5.8	$N_{Rk}$	[kN]	18,3	29,0	42,2	65,3	101,4	142,4
	HAS-U 8.8			24,1	31,1	45,6	65,3	101,4	142,4
	HAS-U A4			24,1	31,1	45,6	65,3	101,4	142,4
	HAS-U HCR			24,1	31,1	45,6	65,3	101,4	142,4
Shear	HAS-U 5.8	$V_{Rk}$	[kN]	9,2	14,5	21,1	39,3	61,3	88,3
	HAS-U 8.8			14,6	23,2	33,7	62,8	98,0	141,2
	HAS-U A4			12,8	20,3	29,5	55,0	85,8	123,6
	HAS-U HCR			14,6	23,2	33,7	62,8	98,0	123,6
<b>Cracked concrete</b>									
Tension	HAS-U 5.8	$N_{Rk}$	[kN]	-	7,1	10,4	16,3	-	-
	HAS-U 8.8			-	7,1	10,4	16,3	-	-
	HAS-U A4			-	7,1	10,4	16,3	-	-
	HAS-U HCR			-	7,1	10,4	16,3	-	-
Shear	HAS-U 5.8	$V_{Rk}$	[kN]	-	14,1	20,7	32,7	-	-
	HAS-U 8.8			-	14,1	20,7	32,7	-	-
	HAS-U A4			-	14,1	20,7	32,7	-	-
	HAS-U HCR			-	14,1	20,7	32,7	-	-

a) Hilti hollow drill bit available for element size M12-M24.

**Design resistance**

Anchor size		M8	M10	M12	M16	M20	M24		
<b>Non-cracked concrete</b>									
Tension	HAS-U 5.8	N <sub>Rd</sub>	[kN]	12,2	17,3	25,3	36,3	56,3	79,1
	HAS-U 8.8			13,4	17,3	25,3	36,3	56,3	79,1
	HAS-U A4			13,4	17,3	25,3	36,3	56,3	79,1
	HAS-U HCR			13,4	17,3	25,3	36,3	56,3	79,1
Shear	HAS-U 5.8	V <sub>Rd</sub>	[kN]	7,3	11,6	16,9	31,4	49,0	70,6
	HAS-U 8.8			11,7	18,6	27,0	50,2	78,4	113,0
	HAS-U A4			8,2	13,0	18,9	35,2	55,0	79,2
	HAS-U HCR			11,7	18,6	27,0	50,2	78,4	70,6
<b>Cracked concrete</b>									
Tension	HAS-U 5.8	N <sub>Rd</sub>	[kN]	-	3,9	5,8	9,1	-	-
	HAS-U 8.8			-	3,9	5,8	9,1	-	-
	HAS-U A4			-	3,9	5,8	9,1	-	-
	HAS-U HCR			-	3,9	5,8	9,1	-	-
Shear	HAS-U 5.8	V <sub>Rd</sub>	[kN]	-	9,4	13,8	21,8	-	-
	HAS-U 8.8			-	9,4	13,8	21,8	-	-
	HAS-U A4			-	9,4	13,8	21,8	-	-
	HAS-U HCR			-	9,4	13,8	21,8	-	-

a) Hilti hollow drill bit available for element size M12-M24.

**Recommended loads <sup>b)</sup>**

Anchor size		M8	M10	M12	M16	M20	M24		
<b>Non-cracked concrete</b>									
Tension	HAS-U 5.8	N <sub>Rec</sub>	[kN]	8,7	12,3	18,1	25,9	40,2	56,5
	HAS-U 8.8			9,6	12,3	18,1	25,9	40,2	56,5
	HAS-U A4			9,6	12,3	18,1	25,9	40,2	56,5
	HAS-U HCR			9,6	12,3	18,1	25,9	40,2	56,5
Shear	HAS-U 5.8	V <sub>Rec</sub>	[kN]	5,2	8,3	12,0	22,4	35,0	50,4
	HAS-U 8.8			8,4	13,3	19,3	35,9	56,0	80,7
	HAS-U A4			5,9	9,3	13,5	25,2	39,3	56,6
	HAS-U HCR			8,4	13,3	19,3	35,9	56,0	50,4
<b>Cracked concrete</b>									
Tension	HAS-U 5.8	N <sub>Rec</sub>	[kN]	-	2,8	4,1	6,5	-	-
	HAS-U 8.8			-	2,8	4,1	6,5	-	-
	HAS-U A4			-	2,8	4,1	6,5	-	-
	HAS-U HCR			-	2,8	4,1	6,5	-	-
Shear	HAS-U 5.8	V <sub>Rec</sub>	[kN]	-	6,7	9,9	15,6	-	-
	HAS-U 8.8			-	6,7	9,9	15,6	-	-
	HAS-U A4			-	6,7	9,9	15,6	-	-
	HAS-U HCR			-	6,7	9,9	15,6	-	-

a) Hilti hollow drill bit available for element size M12-M24.

 b) With overall partial safety factor for action  $\gamma=1,4$ . The partial safety factors for action depend on the type of loading and shall be taken from national regulations.



**Materials**
**Mechanical properties**

Anchor size				M8	M10	M12	M16	M20	M24
Nominal tensile strength	HAS-U 5.8	$f_{uk}$	[N/mm <sup>2</sup> ]	500	500	500	500	500	500
	HAS-U 8.8			800	800	800	800	800	800
	HAS-U A4			700	700	700	700	700	700
	HAS-U HCR			800	800	800	800	800	700
Yield strength	HAS-U 5.8	$f_{yk}$	[N/mm <sup>2</sup> ]	400	400	400	400	400	400
	HAS-U 8.8			640	640	640	640	640	640
	HAS-U A4			450	450	450	450	450	450
	HAS-U HCR			600	600	600	600	600	400
Stressed cross-section	HAS-U	$A_s$	[mm <sup>2</sup> ]	36,6	58,0	84,3	157	245	353
Moment of resistance	HAS-U	W	[mm <sup>3</sup> ]	31,2	62,3	109	277	541	935

**Material quality for HAS-U**

Part	Material
<b>Zinc coated steel</b>	
Threaded rod, HAS-U 5.8 (HDG)	Strength class 5.8; Elongation at fracture $A_5 > 8\%$ ductile Electroplated zinc coated $\geq 5\mu\text{m}$ ; (F) hot dip galvanized $\geq 45\mu\text{m}$
Threaded rod, HAS-U 8.8 (HDG)	Strength class 8.8; Elongation at fracture $A_5 > 12\%$ ductile Electroplated zinc coated $\geq 5\mu\text{m}$ ; (F) hot dip galvanized $\geq 45\mu\text{m}$
Hilti Meter rod, AM 8.8 (HDG)	Strength class 8.8; Elongation at fracture $A_5 > 12\%$ ductile Electroplated zinc coated $\geq 5\mu\text{m}$ (HDG) hot dip galvanized $\geq 45\mu\text{m}$
Washer	Electroplated zinc coated $\geq 5\mu\text{m}$ , hot dip galvanized $\geq 45\mu\text{m}$
Nut	Strength class of nut adapted to strength class of threaded rod. Electroplated zinc coated $\geq 5\mu\text{m}$ , hot dip galvanized $\geq 45\mu\text{m}$
<b>Stainless Steel</b>	
Threaded rod, HAS-U A4	Strength class 70 for $\leq M24$ and strength class 50 for $> M24$ ; Elongation at fracture $A_5 > 8\%$ ductile Stainless steel 1.4401; 1.4404; 1.4578; 1.4571; 1.4439; 1.4362
Washer	Stainless steel 1.4401, 1.4404, 1.4578, 1.4571, 1.4439, 1.4362 EN 10088-1:2014
Nut	Stainless steel 1.4401, 1.4404, 1.4578, 1.4571, 1.4439, 1.4362 EN 10088-1:2014
<b>High corrosion resistant steel</b>	
Threaded rod, HAS-U HCR	Strength class 80 for $\leq M20$ and class 70 for $> M20$ , Elongation at fracture $A_5 > 8\%$ ductile High corrosion resistance steel 1.4529; 1.4565;
Washer	High corrosion resistant steel 1.4529, 1.4565 EN 10088-1:2014
Nut	High corrosion resistant steel 1.4529, 1.4565 EN 10088-1:2014



## Setting information

### Installation temperature:

-5°C to +40°C

### Service temperature range:

Hilti HIT-CT 1 injection mortar may be applied in the temperature ranges given below. An elevated base material temperature may lead to a reduction of the design bond resistance.

Temperature range	Base material temperature	Maximum long term base material temperature	Maximum short term base material temperature
Temperature range I	-40 °C to + 40 °C	+ 24 °C	+ 40 °C
Temperature range II	-40 °C to + 80 °C	+ 50 °C	+ 80 °C

### Maximum short term base material temperature

Short term elevated base material temperatures are those that occur over brief intervals, e.g. as a result of diurnal cycling.

### Maximum long term base material temperature

Long term elevated base material temperatures are roughly constant over significant periods of time.

### Working time and curing time <sup>a)</sup>

Temperature of the base material	Maximum working time	Minimum curing time
$T_{BM}$	$t_{work}$	$t_{cure}^{a)}$
$-5\text{ °C} < t_{BM} < 0\text{ °C}$	1 hour	6 hours
$0\text{ °C} \leq t_{BM} < 5\text{ °C}$	40 min	3 hours
$5\text{ °C} \leq t_{BM} < 10\text{ °C}$	25 min	2 hours
$10\text{ °C} \leq t_{BM} < 20\text{ °C}$	10 min	90 min
$20\text{ °C} \leq t_{BM} < 30\text{ °C}$	4 min	75 min
$30\text{ °C} \leq t_{BM} < 40\text{ °C}$	2 min	60 min

a) The curing time data are valid for dry base material only. In wet material the curing times must be doubled.

**Setting details**

Anchor size			M8	M10	M12	M16	M20	M24
Nominal diameter of element	d	[mm]	8	10	12	16	20	24
Nominal diameter of drill bit	d <sub>0</sub>	[mm]	10	12	14	18	22	28
Effective anchorage and drill hole depth range <sup>a)</sup>	h <sub>ef,min</sub> = h <sub>0</sub>	[mm]	64	80	96	128	160	192
	h <sub>ef,max</sub> = h <sub>0</sub>	[mm]	96	120	144	192	240	288
Minimum base material thickness	h <sub>min</sub>	[mm]	h <sub>ef</sub> + 30 mm ≥ 100 mm			h <sub>ef</sub> + 2 d <sub>0</sub>		
Minimum spacing	s <sub>min</sub>	[mm]	40	50	60	80	100	120
Minimum edge distance	c <sub>min</sub>	[mm]	40	45	45	50	55	60
Maximum diameter of clearance hole in the fixture	d <sub>f</sub>	[mm]	9	12	14	18	22	26
Maximum torque moment <sup>b)</sup>	T <sub>max</sub>	[Nm]	10	20	40	80	150	200
Critical spacing for splitting failure	s <sub>cr,sp</sub>	[mm]	2 C <sub>cr,sp</sub>					
Critical edge distance for splitting failure <sup>c)</sup>	c <sub>cr,sp</sub>	[mm]	<b>1,0 · h<sub>ef</sub></b> for h / h <sub>ef</sub> ≥ 2,0					
			<b>4,6 h<sub>ef</sub> - 1,8 h</b> for 2,0 > h / h <sub>ef</sub> > 1,3					
			<b>2,26 h<sub>ef</sub></b> for h / h <sub>ef</sub> ≤ 1,3					
Critical spacing for concrete cone failure	s <sub>cr,N</sub>	[mm]	2 C <sub>cr,N</sub>					
Critical edge distance for concrete cone failure <sup>c)</sup>	c <sub>cr,N</sub>	[mm]	1,5 h <sub>ef</sub>					

For spacing (edge distance) smaller than critical spacing (critical edge distance) the design loads have to be reduced.

- a)  $h_{ef,min} \leq h_{ef} \leq h_{ef,max}$  (h<sub>ef</sub>: embedment depth)
- b) Maximum recommended torque moment to avoid splitting failure during installation with min. spacing and/or edge distance
- c) h: base material thickness (h ≥ h<sub>min</sub>)

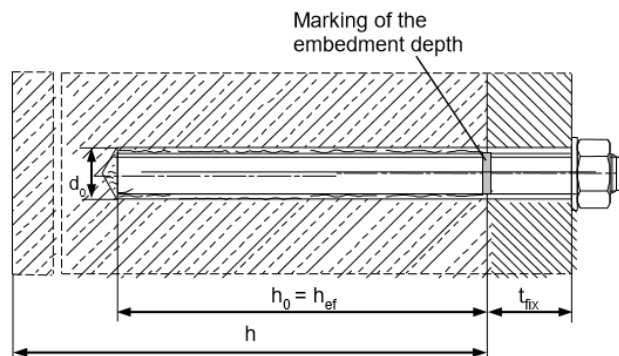
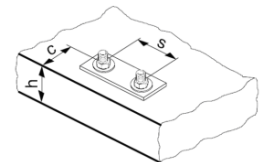

**Installation equipment**

Anchor size	M8	M10	M12	M16	M20	M24
Rotary hammer	TE 2 (-A) – TE 16 (-A)				TE 40 – TE 80	
Other tools	Blow out pump ( $h_{ef} < 10 \cdot d$ ), Compressed air gun, Set of cleaning brushes, dispenser					

**Parameters of cleaning and setting tools**

HAS-U	Drilling		Cleaning		Installation
	Hammer drill (HD)	Hollow Drill Bit (HDB)	Brush HIT-RB	Air nozzle HIT-RB	Piston plug HIT-SZ
	$d_0$ [mm]		size [mm]		
<b>M8</b>	10	-	10	-	-
<b>M10</b>	12	-	12	12	12
<b>M12</b>	14	14	14	14	14
<b>M16</b>	18	18	18	18	18
<b>M20</b>	22	22	22	22	22
<b>M24</b>	28	28	28	28	28

**Setting instructions**

**\*For detailed information on installation see instruction for use given with the package of the product.**

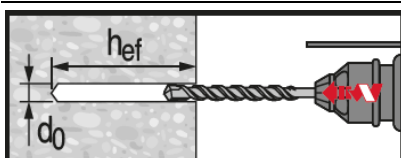
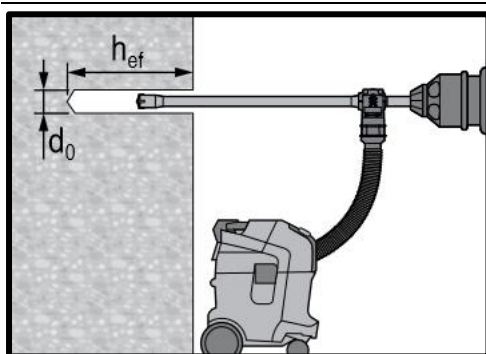

**Safety regulations,**

Review the Material Safety Data Sheet (MSDS) before use for proper and safe handling! Wear well-fitting protective goggles and protective gloves when working with Hilti HIT-CT 1.

**Drilling**

**Hammer drilled hole (HD)**

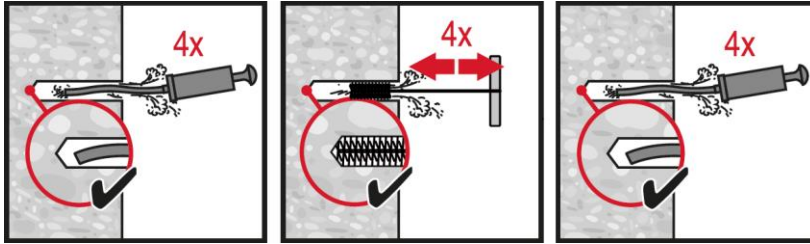
**Hammer drilled hole with Hollow drill bit (HDB)**

No cleaning required

**Cleaning**



**Manual cleaning (MC)**

for drill diameters  $d_0 \leq 20$  mm and drill hole depth  $h_0 \leq 10 \cdot d$  in uncracked concrete

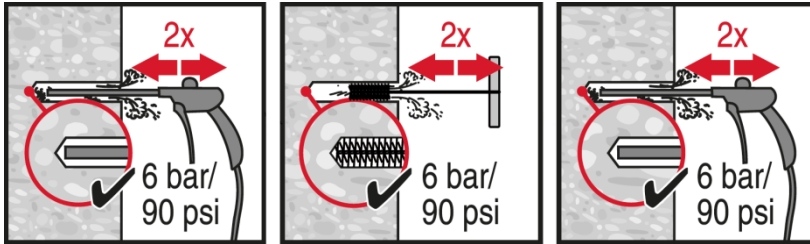

**Compressed air cleaning (CAC)**

for all drill hole diameters  $d_0$  and drill hole depths  $h_0 \leq 12 \cdot d$ .

**Injection**

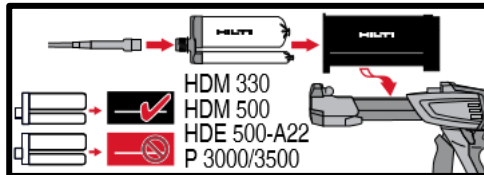

**Injection system preparation**

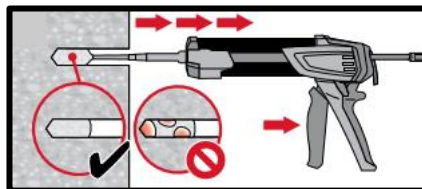
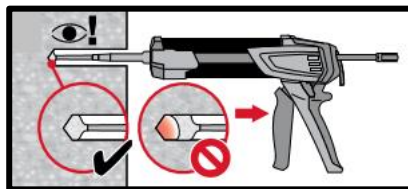
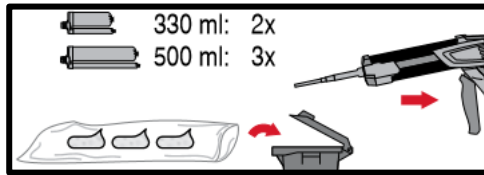

**Injection method for drill hole depth**

$h_{ef} \leq 250$  mm.

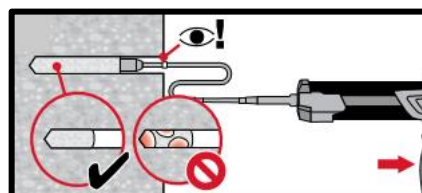
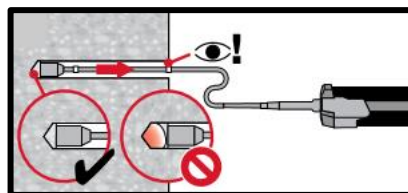

**Injection method for drill hole depth**

$h_{ef} > 250$ mm.

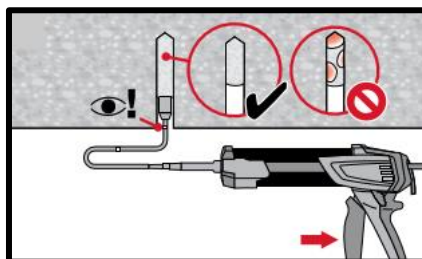
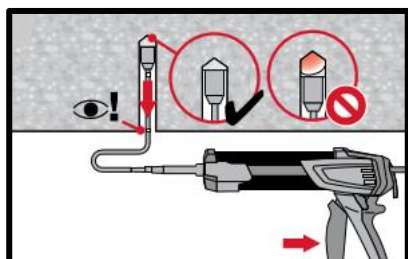

**Injection method for overhead application**

---

**Setting the element**

---

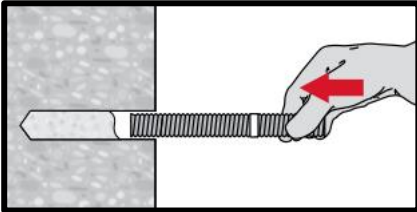

**Setting element**, observe working time " $t_{work}$ ".

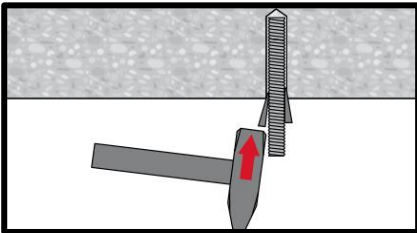

**Setting element** for overhead applications, observe working time " $t_{work}$ ".

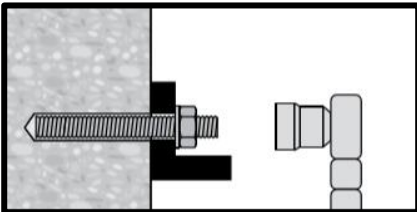

**Loading the anchor:** After required curing time  $t_{cure}$  the anchor can be loaded.

---

# HIT-CT 1 injection mortar

## Anchor design (EN 1992-4) / Rebar elements / Concrete

### Injection mortar system



Hilti HIT- CT 1

330 ml foil pack  
(also available as  
500 ml foil pack)



Rebar B500 B

( $\phi 8$ - $\phi 25$ )

### Benefits

- **SafeSet** technology: Hilti hollow drill bit for hammer drilling
- Suitable for non-cracked concrete C20/25 to C50/60
- Suitable for dry and water saturated concrete
- High loading capacity and fast curing
- Hybrid chemistry
- Good load capacity at elevated temperatures, and suitable for applications down to -5°C

### Base material



Concrete  
(non-cracked)



Dry concrete



Wet concrete

### Load condition

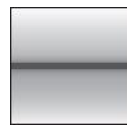

Static/  
quasi-static

### Installation conditions

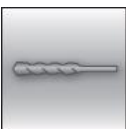

Hammer  
drilling

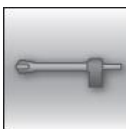

Hollow drill-  
bit drilling

**SAFESET**

Hilti **SafeSet**  
technology

### Other information



European  
Technical  
Assessment



CE  
conformity



PROFIS  
Engineering  
design  
Software

### Approvals / certificates

Description	Authority / Laboratory	No. / date of issue
European technical assessment <sup>a)</sup>	CSTB, Marne la Vallée	ETA-11/0354 / 2020-09-01

b) All data given in this section according to ETA-11/0354 issue 2020-09-01.

## Static and quasi-static loading (for a single anchor)

### All data in this section applies to

- Correct setting (see installation instruction)
- No edge distance and spacing influence
- Steel failure
- Base material thickness, as specified in the table
- Embedment depth, as specified in the table
- Concrete C 20/25,  $f_{ck,cube} = 25 \text{ N/mm}^2$
- In-service temperate range I  
(min. base material temperature  $-40^\circ\text{C}$ , max. long term/short term base material temperature:  $+24^\circ\text{C}/40^\circ\text{C}$ )

### Embedment depth <sup>a)</sup> and base material thickness

Anchor- size		$\phi 8$	$\phi 10$	$\phi 12$	$\phi 14$	$\phi 16$	$\phi 20$	$\phi 25$
Typical embedment depth	$h_{ef}$ [mm]	80	90	110	125	130	170	210
Base material thickness	$h$ [mm]	110	120	145	160	170	220	274

b) The allowed range of embedment depth is shown in the setting details

### For hammer drilled holes and Hilti hollow drill bit<sup>a)</sup>:

#### Characteristic resistance

Anchor- size		$\phi 8$	$\phi 10$	$\phi 12$	$\phi 14$	$\phi 16$	$\phi 20$	$\phi 25$
Tensile	Rebar B500B $N_{Rk}$ [kN]	14,1	21,2	31,1	41,2	49,0	85,5	132,0
Shear	Rebar B500B $V_{Rk}$ [kN]	14,0	22,0	31,0	42,0	55,0	86,0	135,0

a) Hilti hollow drill bit available for element size  $\phi 8 - \phi 25$ .

#### Design resistance

Anchor- size		$\phi 8$	$\phi 10$	$\phi 12$	$\phi 14$	$\phi 16$	$\phi 20$	$\phi 25$
Tensile	Rebar B500B $N_{Rd}$ [kN]	7,8	11,8	17,3	22,9	27,2	47,5	73,3
Shear	Rebar B500B $V_{Rd}$ [kN]	9,3	14,7	20,7	28,0	36,7	57,3	90,0

a) Hilti hollow drill bit available for element size  $\phi 8 - \phi 25$ .

#### Recommended loads<sup>b)</sup>

Anchor- size		$\phi 8$	$\phi 10$	$\phi 12$	$\phi 14$	$\phi 16$	$\phi 20$	$\phi 25$
Tensile	Rebar B500B $N_{Rd}$ [kN]	5,6	8,4	12,3	16,4	19,4	33,9	52,4
Shear	Rebar B500B $V_{Rd}$ [kN]	6,7	10,5	14,8	20,0	26,2	41,0	64,3

a) Hilti hollow drill bit available for element size  $\phi 8 - \phi 25$ .

b) With overall partial safety factor for action  $\gamma = 1,4$ . The partial safety factors for action depend on the type of loading and shall be taken from national regulations.

## Materials

### Mechanical properties

Anchor size			φ8	φ10	φ12	φ14	φ16	φ20	φ25
Nominal tensile strength	$f_{uk}$	[N/mm <sup>2</sup> ]	550	550	550	550	550	550	550
Yield strength	$f_{yk}$	[N/mm <sup>2</sup> ]	500	500	500	500	500	500	500
Stressed cross-section	$A_s$	[mm <sup>2</sup> ]	50,3	78,5	113	1534	201	314	491
Moment of resistance	$W$	[mm <sup>3</sup> ]	50,3	98,2	170	269	402	785	1534

### Material quality

Part	Material
Rebar B500 B	EN 1992-1-1:2004 and AC:2010, Annex C Bars and de-coiled rods Class B or C with $f_{yk}$ and $k$ according to NDP or NCL of EN 1992-1-1/NA:2013

## Setting information

### Installation temperature:

-5°C to +40°C

### Service temperature range:

Hilti HIT-CT 1 injection mortar may be applied in the temperature ranges given below. An elevated base material temperature may lead to a reduction of the design bond resistance.

Temperature range	Base material temperature	Maximum long term base material temperature	Maximum short term base material temperature
Temperature range I	-40 °C to + 40 °C	+ 24 °C	+ 40 °C
Temperature range II	-40 °C to + 80 °C	+ 50 °C	+ 80 °C

### Maximum short term base material temperature

Short term elevated base material temperatures are those that occur over brief intervals, e.g. as a result of diurnal cycling.

### Maximum long term base material temperature

Long term elevated base material temperatures are roughly constant over significant periods of time.

### Working time and curing time <sup>a)</sup>

Temperature of the base material	Maximum working time	Minimum curing time
$T_{BM}$	$t_{work}$	$t_{cure}$ <sup>a)</sup>
-5 °C < $t_{BM}$ < 0 °C	1 hour	6 hours
0 °C ≤ $t_{BM}$ < 5 °C	40 min	3 hours
5 °C ≤ $t_{BM}$ < 10 °C	25 min	2 hours
10 °C ≤ $t_{BM}$ < 20 °C	10 min	90 min
20 °C ≤ $t_{BM}$ < 30 °C	4 min	75 min
30 °C ≤ $t_{BM}$ < 40 °C	2 min	60 min

a) The curing time data are valid for dry base material only. In wet material the curing times must be doubled.



**Setting details**

Anchor size		$\phi 8$	$\phi 10$	$\phi 12$	$\phi 14$	$\phi 16$	$\phi 20$	$\phi 25$
Nominal diameter of element	d [mm]	8	10	12	14	16	20	25
Nominal diameter of drill bit	d <sub>0</sub> [mm]	10 / 12 <sup>a)</sup>	12 / 14 <sup>a)</sup>	14 <sup>a)</sup> / 16 <sup>a)</sup>	18	20	25	30 / 32 <sup>a)</sup>
Effective anchorage depth (=drill hole depth)	$\frac{h_{ef,min} = h_0}{h_{ef,max} = h_0}$ [mm]	64	80	96	112	128	160	200
		96	120	144	168	192	240	300
Minimum base material thickness	h <sub>min</sub> [mm]	$h_{ef} + 30 \text{ mm}$ $\geq 100 \text{ mm}$			$h_{ef} + 2 d_0$			
Minimum spacing	s <sub>min</sub> [mm]	40	50	60	70	80	100	125
Minimum edge distance	c <sub>min</sub> [mm]	40	45	45	50	50	65	70
Critical spacing for splitting failure	s <sub>cr,sp</sub> [mm]	2 c <sub>cr,sp</sub>						
Critical edge distance for splitting failure <sup>b)</sup>	c <sub>cr,sp</sub> [mm]	<b>1,0 · h<sub>ef</sub></b> for $h / h_{ef} \geq 2,0$						
		<b>4,6 h<sub>ef</sub> - 1,8 h</b> for $2,0 > h / h_{ef} > 1,3$						
		<b>2,26 h<sub>ef</sub></b> for $h / h_{ef} \leq 1,3$						
Critical spacing for concrete cone failure	s <sub>cr,N</sub> [mm]	3,0 h <sub>ef</sub>						
Critical edge distance for concrete cone failure	c <sub>cr,N</sub> [mm]	1,5 h <sub>ef</sub>						

For spacing (edge distance) smaller than critical spacing (critical edge distance) the design loads have to be reduced.

- a) Both given values for drill bit diameter can be used  
 b) h: base material thickness ( $h \geq h_{min}$ ), h<sub>ef</sub>: embedment depth

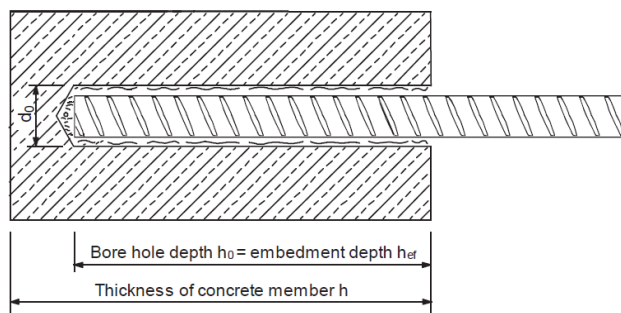
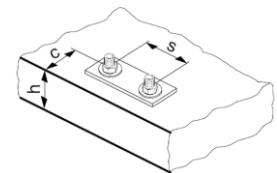
**Installation equipment**

Anchor size	$\phi 8$	$\phi 10$	$\phi 12$	$\phi 14$	$\phi 16$	$\phi 20$	$\phi 25$
Rotary hammer	TE 2 – TE 30					TE 40 – TE 80	
Other tools	blow out pump ( $h_{ef} \leq 10 \cdot d$ ), compressed air gun set of cleaning brushes, dispenser						

**Parameters of cleaning and setting tools**

Rebar	Drilling		Cleaning		Installation
	Hammer drilling (HD)	Hollow Drill Bit (HDB)	Brush HIT-RB	Piston plug HIT-SZ	Piston plug HIT-SZ
	d <sub>0</sub> [mm]		size [mm]		
φ8	10 / 12 <sup>a)</sup>	-	10 / 12 <sup>a)</sup>	- / 12	- / 12
φ10	12 / 14 <sup>a)</sup>	14	12 / 14 <sup>a)</sup>	12 / 14 <sup>a)</sup>	12 / 14 <sup>a)</sup>
φ12	14 / 16 <sup>a)</sup>	16 (14 <sup>a)</sup> )	14 / 16 <sup>a)</sup>	14 / 16 <sup>a)</sup>	14 / 16 <sup>a)</sup>
φ14	18	18	18	18	18
φ16	20	20	20	20	20
φ20	25	25	25	25	25
φ25	32	32	32	32	32

a) Each of the two given values can be used

**Setting instructions**

**\*For detailed information on installation see instruction for use given with the package of the product.**

**Safety regulations,**

Review the Material Safety Data Sheet (MSDS) before use for proper and safe handling! Wear well-fitting protective goggles and protective gloves when working with Hilti HIT-CT 1.

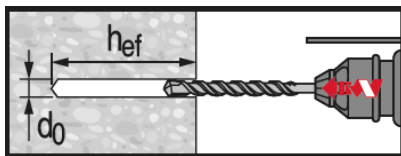
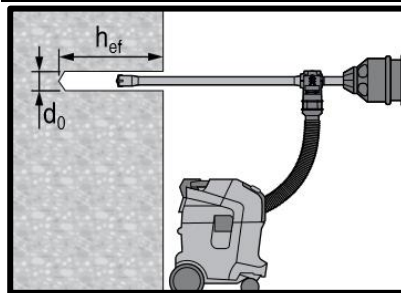
**Drilling**

**Hammer drilled hole (HD)**

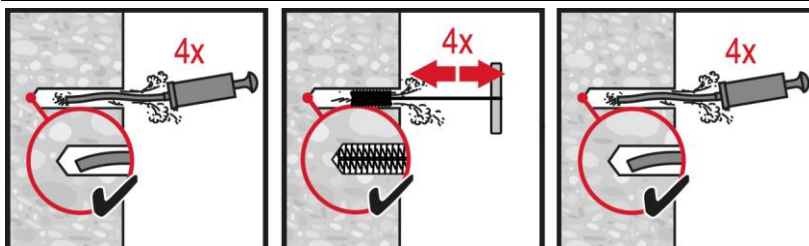
**Hammer drilled hole with Hollow drill bit (HDB)**

No cleaning required

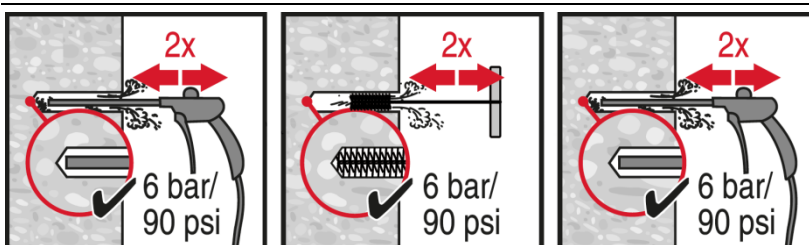
**Cleaning**

**Manual cleaning (MC)**

for drill diameters  $d_0 \leq 20$  mm and drill hole depth  $h_0 \leq 10 \cdot d$  in uncracked concrete.

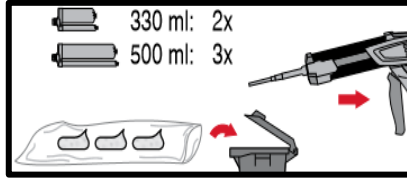
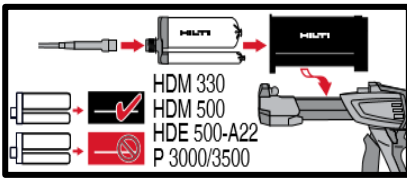

**Compressed air cleaning (CAC)**

for all drill hole diameters  $d_0$  and drill hole depths  $h_0 \leq 12 \cdot d$ .

**Injection**

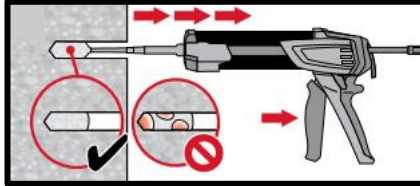
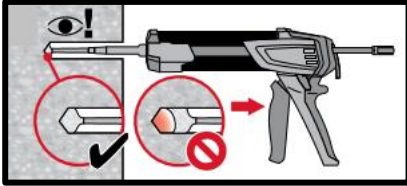

**Injection system preparation**



**Injection method for drill hole depth**  
 $h_{ef} \leq 250 \text{ mm}$ .

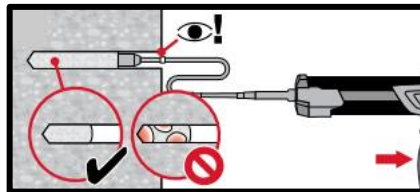
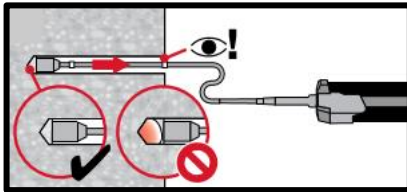

**Injection method for drill hole depth**  
 $h_{ef} > 250 \text{ mm}$ .

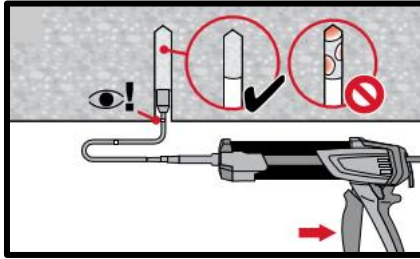
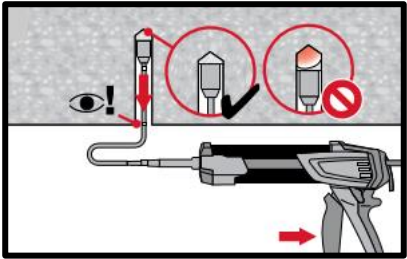

**Injection method for overhead application**

**Setting the element**

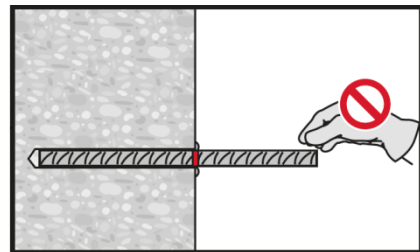
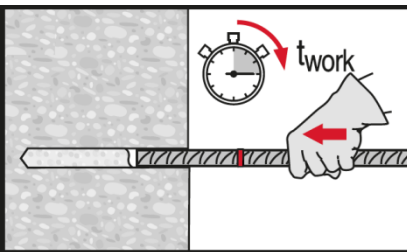

**Setting element**, observe working time " $t_{work}$ ".

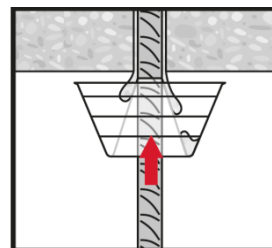
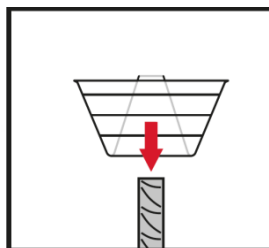
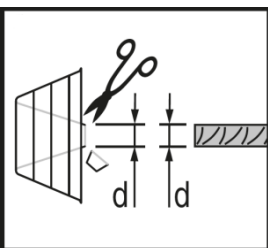

**Setting element for overhead applications**, observe working time " $t_{work}$ ".

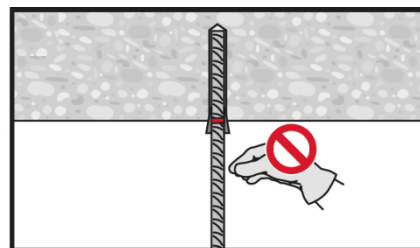
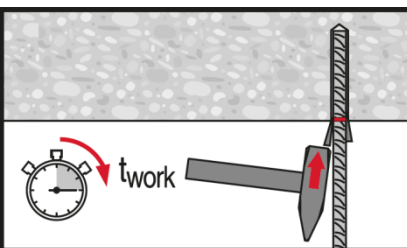

**Loading the anchor:** After required curing time  $t_{cure}$  the anchor can be loaded.

# HIT-CT 1 injection mortar

Rebar design (EOTA TR023) / Rebar elements / Concrete

## Injection mortar system



Hilti HIT- CT 1  
330 ml foil pack  
(also available as  
500 ml foil pack)

Rebar B500 B  
( $\phi 8 - \phi 25$ )

## Benefits

- **SafeSet** technology: Hilti hollow drill bit for hammer drilling
- Suitable for concrete C12/15 to C50/60
- Suitable for dry or wet concrete
- High loading capacity and fast curing
- Hybrid chemistry
- Suitable for dry and water saturated concrete
- For rebar diameters up to 25 mm
- Non-corrosive to rebar elements

## Base material

## Load conditions



Concrete  
(non-cracked)



Dry concrete



Wet  
concrete

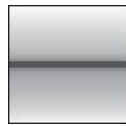

Static/  
quasi-static



Fire  
resistance

## Installation conditions

## Other information

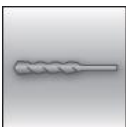

Hammer  
drilled holes

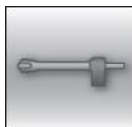

Hollow drill-  
bit drilling

**SAFESET**

Hilti SafeSet  
technology  
with hollow  
drill bit



European  
Technical  
Assessment



CE  
conformity



PROFIS  
Engineering  
design  
Software

## Approvals / certificates

Description	Authority / Laboratory	No. / date of issue
European Technical Assessment <sup>a)</sup>	CSTB, Marne la Vallée	ETA-11/0390 / 2019-10-16
Fire report	CSTB, Marne la Vallée	n° 26059386 / 2015-10-23

c) All data given in this section according to the approvals mentioned above ETA-11/0390 issue 2019-10-16

## Static and quasi-static loading

### Static EC2 design

#### Design bond strength in N/mm<sup>2</sup> accord. to ETA 11/0390 for good bond conditions

All allowed drilling methods									
Rebar - size	Concrete class								
	C12/15	C16/20	C20/25	C25/30	C30/37	C35/45	C40/50	C45/55	C50/60
φ8 - φ25	1,6	2,0	2,3	2,7	3,0	3,0	3,0	3,0	3,0

For poor bond conditions multiply the values by 0,7. Values valid for non-cracked and cracked concrete

### Minimum anchorage length and minimum lap length

The minimum anchorage length  $l_{b,min}$  and the minimum lap length  $l_{0,min}$  according to EN 1992-1-1 shall be multiplied by relevant **Amplification factor**  $\alpha_{lb}$  in the table below.

#### Amplification factor $\alpha_{lb}$ for the min. anchorage length and min. lap length according to EN 1992-1-1 for:

All allowed drilling methods									
Rebar - size	Concrete class								
	C12/15	C16/20	C20/25	C25/30	C30/37	C35/45	C40/50	C45/55	C50/60
φ8 - φ25	1,0			1,2	1,4				

#### Anchorage length for characteristic steel strength $f_{yk}=500$ N/mm<sup>2</sup> for good conditions

All allowed drilling methods								
Size	$f_{y,k}$ [N/mm <sup>2</sup> ]	$l_{b,min}^*$ [mm]			$l_{0,min}^*$ [mm]			$l_{max}$ [mm]
		C20/25	C25/30	C30/37- C50/60	C20/25	C25/30	C30/37- C50/60	
φ8	500	113	120	140	200	240	280	700
φ10	500	142	145	152	200	240	280	700
φ12	500	170	174	183	200	240	280	700
φ14	500	199	203	213	210	252	294	700
φ16	500	227	232	244	240	288	336	700
φ18	500	255	261	274	270	324	378	500
φ20	500	284	290	305	300	360	420	500
φ22	500	312	319	335	330	396	462	500
φ24	500	340	348	365	360	432	-	500
φ25	500	355	363	381	375	450	-	500

According to EN 1992-1-1  $l_{b,min}$  (8.6) are calculated for good bond conditions with maximum yield strength  $f_{yk}=1,15$  and  $\alpha_6 = 1,0$

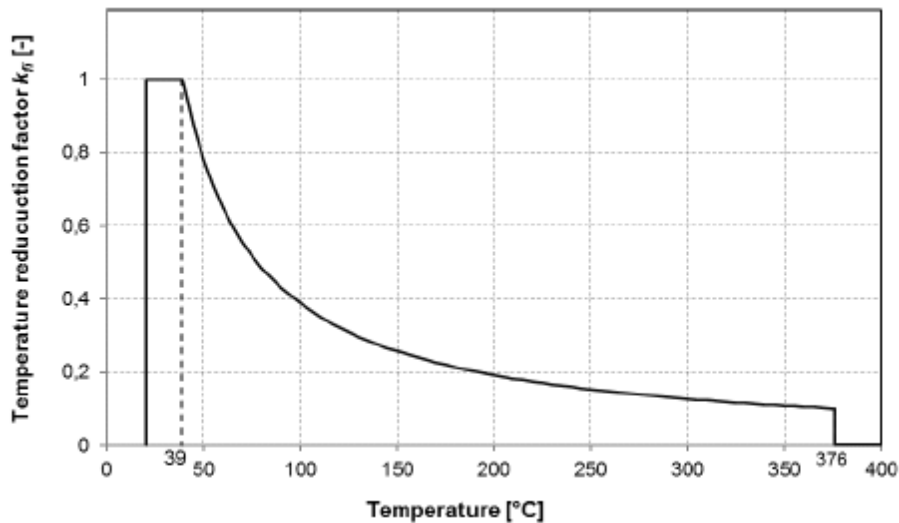
**Fire resistance**
**Temperature reduction factor  $k_{fi}(\theta)$** 

The analytic equation that describe the variation of  $k_{fi}(\theta)$  with temperature is given by the following function:

$$\begin{aligned} \text{If } 39^\circ\text{C} \leq \theta \leq 376^\circ\text{C:} & \quad k_{fi}(\theta) = 41,001 \times \theta^{-1,012} \leq 1,0 \text{ in } ^\circ\text{C} \\ \text{If } \theta < 39^\circ\text{C} & \quad k_{fi}(\theta) = 1,0 \\ \text{If } \theta > 376^\circ\text{C} & \quad k_{fi}(\theta) = 0,0 \end{aligned}$$

The design value of ultimate bond strength  $f_{bd,fi}$  under fire exposure is calculated according to following equation:

$$f_{bd,fi} = k_{fi}(\theta) \cdot f_{bd} \cdot \gamma_c / \gamma_{M,fi}$$

With:

- $k_{fi}(\theta)$  temperature reduction factor under fire exposure.
- $f_{bd}$  design values of the ultimate bond resistance according to amplification factor  $\alpha_{lb}$
- $\gamma_c = 1,5$  recommended safety factor according to EN 1992-1-1.
- $\gamma_{M,fi}$  safety factor according to EN 1992-1-2 under fire exposure.

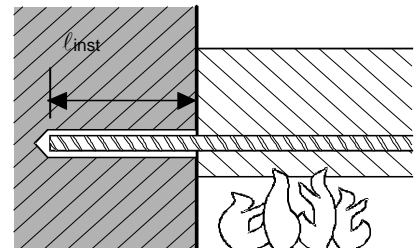
**a) Anchoring application**

**Anchoring application beam-wall connections with a concrete cover of 20 mm**

Maximum force ( $F_{s,T,max}$ ) in rebar in conjunction with HIT-CT 1 as a function of embedment depth ( $l_{inst}$ ) for the fire resistance classes R30 to R240 according to EC2.

Rebar-size	$F_{s,T,max}$ [kN]	$l_{inst}$ [mm]	Fire resistance of bar [kN]					
			R30	R60	R90	R120	R180	R240
$\phi 8$	16,8	100	4,0	2,0	1,2	0,9	0,5	0,3
		140	7,4	4,7	3,0	2,3	1,5	1,1
		180	10,9	8,2	6,1	4,6	3,0	2,2
		220	14,4	11,7	9,5	7,9	5,3	3,9
		250	16,8	14,3	12,1	10,5	7,6	5,6
		280		16,8	14,7	13,1	10,2	7,9
		310	16,8		16,8	16,8	15,7	12,8
		330		14,5			12,2	
		360	16,8	14,8				
		390		16,8				
		<b>f10</b>		110	6,0	3,1	2,0	1,5

Maximum force ( $F_{s,T,max}$ ) in rebar in conjunction with HIT-CT 1 as a function of embedment depth ( $\ell_{inst}$ ) for the fire resistance classes R30 to R240 according to EC2.

Rebar-size	$F_{s,T,max}$ [kN]	$\ell_{inst}$ [mm]	Fire resistance of bar [kN]							
			R30	R60	R90	R120	R180	R240		
	26,2	150	10,4	7,0	4,6	3,5	2,2	1,6		
		190	14,7	11,3	8,7	6,7	4,3	3,2		
		230	19,0	15,7	13,0	10,9	7,5	5,6		
		300	26,2	26,2	23,3	20,6	18,5	14,9	12,0	
		330			23,8	21,8	18,2	15,2		
		360			26,2	25,0	21,4	18,5		
		380				23,6	20,6			
		410				26,2	23,9			
		440			26,2	26,2				
$\phi 12$	37,7	140			11,1	7,1	4,5	3,5	2,2	1,6
		200			18,9	14,9	11,7	9,2	6,0	4,5
		260			26,7	22,7	19,5	17,0	12,7	9,5
		320	34,6	30,5	27,3	24,8	20,5	17,0		
		350	37,7	37,7	34,4	31,2	28,7	24,4	20,9	
		380			35,1	32,6	28,3	24,8		
		400			37,7	35,3	30,9	27,4		
		420				33,5	30,0			
		460				37,7	35,2			
		480			37,7	37,7				
$\phi 14$	51,3	160			16,0	11,3	7,7	5,8	3,7	2,8
		220			25,1	20,4	16,7	13,8	9,2	6,9
		280			34,2	29,5	25,8	22,9	17,9	13,8
		340			43,3	38,6	34,9	32,0	27,0	22,8
		400	51,3	51,3	47,7	44,0	41,1	36,1	31,9	
		430			48,5	45,7	40,6	36,5		
		450			51,3	48,7	43,7	39,5		
		470				46,7	42,6			
		510				51,3	48,6			
		530			51,3	51,3				
$\phi 16$	67,0	180			21,8	16,4	12,1	9,1	6,0	4,4
		240			32,2	26,8	22,5	19,3	13,5	10,0
		300			42,6	37,2	32,9	29,7	23,9	19,2
		360			53,0	47,6	43,3	40,1	34,3	29,6
		450	67,0	67,0	63,2	58,9	55,7	49,9	45,2	
		480			64,1	60,9	55,1	50,4		
		500			67,0	64,3	58,6	53,8		
		520				62,0	57,3			
		550				67,0	62,5			
		580			67,0	67,0				
$\phi 20$	104,7	220			35,9	29,2	23,8	19,7	13,1	9,8
		280			48,9	42,2	36,8	32,7	25,5	19,7
		340			61,9	55,2	49,8	45,7	38,5	32,6
		400			74,9	68,2	62,8	58,8	51,5	45,6
		460	87,9	81,2	75,8	71,8	64,5	58,6		
		540	104,7	104,7	98,5	93,2	89,1	81,9	76,0	
		570			99,7	95,6	88,4	82,5		
		600			104,7	102,1	94,9	89,0		
		620				99,2	93,3			
		650				104,7	99,8			
		680			104,7	104,7				

\*For additional values please check CSTB report n°26048096.

Characteristic yield strength  $f_{yk} = 500 \text{ N/mm}^2$

Steel failure

## b) Overlap joint application



Max. bond stress,  $f_{bd, FIRE}$ , depending on actual clear concrete cover for classifying the fire resistance. It must be verified that the actual force in the bar during a fire,  $F_{s, T}$ , can be taken up by the bar connection of the selected length,  $l_{inst}$ . Note: Cold design for ULS is mandatory.

$$F_{s, T} \leq (l_{inst} - c_f) \cdot \phi \cdot \pi \cdot f_{bd, FIRE} \quad \text{where: } (l_{inst} - c_f) \geq l_s;$$

$l_s$  = lap length

$\phi$  = nominal diameter of bar

$l_{inst} - c_f$  = selected overlap joint length; this must be at least  $l_s$ ,

but may not be assumed to be more than  $80 \phi$

$f_{bd, FIRE}$  = bond stress when exposed to fire

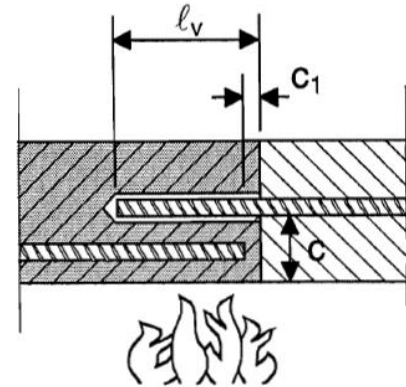

**Critical temperature-dependent bond stress,  $f_{bd, FIRE}$ , concerning “overlap joint” for Hilti HIT-CT 1 injection adhesive in relation to fire resistance class and required minimum concrete coverage  $c$ .**

Clear concrete cover $c$ [mm]	Max. bond stress, $\tau_c$ [N/mm <sup>2</sup> ]					
	R30	R60	R90	R120	R180	R240
20	0,4					
30	0,6					
40	0,9	0,5				
50	1,2	0,6	0,4			
60	1,6	0,8	0,5	0,4		
70	2,0	1,0	0,7	0,5	0,4	
80	2,6	1,3	0,9	0,6	0,4	0,4
90	3,2	1,5	1,0	0,8	0,5	0,4
100		1,8	1,2	0,9	0,6	0,5
110		2,2	1,4	1,1	0,7	0,5
120		2,6	1,7	1,3	0,9	0,6
130		3,0	1,9	1,4	1,0	0,7
140			2,2	1,6	1,1	0,9
150			2,5	1,8	1,2	1,0
160			2,9	2,1	1,4	1,1
170			3,3	2,4	1,5	1,2
180				2,7	1,7	1,3
190				3,0	1,9	1,4
200		3,5		3,3	2,1	1,6
210					2,3	1,7
220			3,5		2,6	1,9
230					2,8	2,0
240				3,5	3,1	2,2
250					3,3	2,4
260						2,6
270						2,8
280						3,1
290						3,3
300						3,5



## Materials

### Material quality

Part	Material
Rebar EN 1992-1-1	Bars and de-coiled rods class B or C with $f_{yk}$ and $k$ according to NDP or NCL of EN 1992-1-1 $f_{uk} = f_{tk} = k \cdot f_{yk}$

### Fitness for use

Some creep tests have been conducted in accordance with ETAG guideline 001 part 5 and TR 023 in the following conditions: **in dry environment at 50 °C during 90 days.**

These tests show an excellent behaviour of the post-installed connection made with HIT-CT 1: low displacements with long term stability, failure load after exposure above reference load.

### Resistance to chemical substances

Chemical	Resistance	Chemical	Resistance
Acetic acid 100%	o	Methanol 100%	o
Acetic acid 10%	+	Peroxide of hydrogen 30%	o
Hydrochloric Acid 20%	+	Solution of phenol (sat.)	-
Nitric Acid 40%	-	Sodium hydroxide pH=14	+
Phosphoric Acid 40%	+	Solution of chlorine (sat.)	+
Sulphuric acid 40%	+	Solution of hydrocarbons (60 % vol Toluene, 30 % vol Xylene, 10 % vol Methyl naphthalene)	+
Ethyl acetate 100%	o	Salted solution 10%	+
Acetone 100%	-	Sodium chloride	
Ammoniac 5%	o	Suspension of concrete (sat.)	+
Diesel 100%	+	Chloroform 100%	+
Gasoline 100%	+	Xylene 100%	+
Ethanol 96%	o		
Machine oils 100%	+		

- + resistant
- o resistant in short term (max. 48h) contact
- not resistant

### Electrical Conductivity

HIT-CT 1 in the hardened state **is not conductive electrically**. Its electric resistivity is  $1,4 \cdot 10^{10} \Omega \cdot m$  (DIN IEC 93 – 12.93). It is adapted well to realize electrically insulating anchoring (ex: railway applications, subway).

## Setting information

### Installation temperature range:

-5°C to +40°C

### Service temperature range

Hilti HIT-CT 1 injection mortar may be applied in the temperature ranges given below. An elevated base material temperature may lead to a reduction of the design bond resistance.

Temperature range	Base material temperature	Maximum long term base material temperature	Maximum short term base material temperature
Temperature range	-40 °C to +80 °C	+50°C	+80 °C

### Maximum short term base material temperature

Short-term elevated base material temperatures are those that occur over brief intervals, e.g. as result of diurnal cycling.

### Maximum long term base material temperature

Long-term elevated base material temperatures are roughly constant over significant periods of time.

### Working time and curing time <sup>a)</sup>

Temperature of the base material	Maximum working time	Minimum curing time
$T_{BM}$	$t_{work}$	$t_{cure}^{a)}$
-5 °C < $t_{BM}$ < 0 °C	60 min	6 h
0 °C ≤ $t_{BM}$ < 5 °C	40 min	3 h
5 °C ≤ $t_{BM}$ < 10 °C	25 min	2 h
10 °C ≤ $t_{BM}$ < 20 °C	10 min	90 min
20 °C ≤ $t_{BM}$ < 30 °C	4 min	75 min
30 °C ≤ $t_{BM}$ < 40 °C	2 min	60 min

a) The curing time data are valid for dry anchorage base only. For water saturated anchorage bases the curing times must be doubled.

### Installation equipment

Rebar size	φ8	φ10	φ12	φ14	φ16	φ18	φ20	φ22	φ24	φ25
Rotary hammer	TE2(-A) – TE30(-A)						TE40 – TE80			
Other tools	Blow out pump ( $h_{ef} \leq 10 \cdot d$ )						-			
	Compressed air gun <sup>a)</sup> Set of cleaning brushes <sup>b)</sup> , dispenser, piston plug									

a) Compressed air gun with extension hose for all drill holes deeper than 250 mm (for φ 8 to φ 12) or deeper than  $20 \cdot \phi$  (for φ > 12 mm)

b) Automatic brushing with round brush for all drill holes deeper than 250 mm (for φ 8 to φ 12) or deeper than  $20 \cdot \phi$  (for φ > 12 mm)

### Minimum concrete cover $c_{min}$ of the post-installed rebar



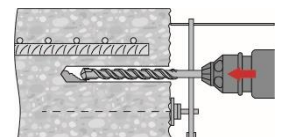



Drilling method	Rebar – size [mm]	Minimum concrete cover $c_{min}$ [mm]	
		Without drilling aid	With drilling aid
Hammer drilling (HD) and HD with Hilti hollow drill bit (HDB)	φ ≤ 24	$30 + 0,06 \cdot l_v \geq 2 \cdot \phi$	$30 + 0,02 \cdot l_v \geq 2 \cdot \phi$
	φ = 25	$40 + 0,06 \cdot l_v \geq 2 \cdot \phi$	$40 + 0,02 \cdot l_v \geq 2 \cdot \phi$
Compressed air drilling (CA)	φ ≤ 24	$50 + 0,08 \cdot l_v$	$50 + 0,02 \cdot l_v$
	φ = 25	$60 + 0,08 \cdot l_v \geq 2 \cdot \phi$	$60 + 0,02 \cdot l_v \geq 2 \cdot \phi$

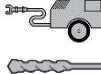

**Dispenser and corresponding maximum embedment depth  $l_{v,max}$** 

Rebar – size [mm]	Dispenser (HDM 330, HDM 500, HDE 500)	
	$l_{v,max}$ [mm]	
$\phi 8 - \phi 16$	700	
$\phi 18 - \phi 25$	500	

**Parameters of cleaning and setting tools**

Rebar	Drilling			Cleaning		Installation
	Hammer drilling (HD)	Hollow Drill Bit (HDB) <sup>a)</sup>	Compressed air drilling (CA)	Brush HIT-RB	Air nozzle HIT-RB	Piston plug HIT-SZ
	$d_0$ [mm]			size [mm]		
						
$\phi 8$	10 12	- 12	- -	10 12	- 12	- 12
$\phi 10$	12 14	12 14	- -	12 14	12 14	12 14
$\phi 12$	14 16 -	14 16 -	- - 17	14 16 18	14 16 16	14 16 16
$\phi 14$	18 -	18 -	- 17	18 18	18 16	18 16
$\phi 16$	20	20	20	20	20	20
$\phi 18$	22	22	22	22	22	22
$\phi 20$	25 -	25 -	- 26	25 28	25 25	25 25
$\phi 22$	28	28	28	28	28	28
$\phi 24$	32	32	32	32	32	32
$\phi 25$	32	32	32	32	32	32

a) No cleaning required

## Setting instructions

\*For detailed information on installation see instruction for use given with the package of the product.



### Safety regulations.

Review the Material Safety Data Sheet (MSDS) before use for proper and safe handling! Wear well-fitting protective goggles and protective gloves when working with Hilti HIT-CT1.

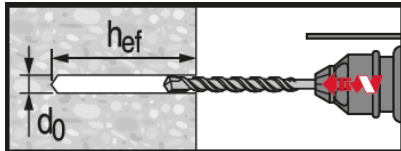

### Hammer drilled hole (HD)

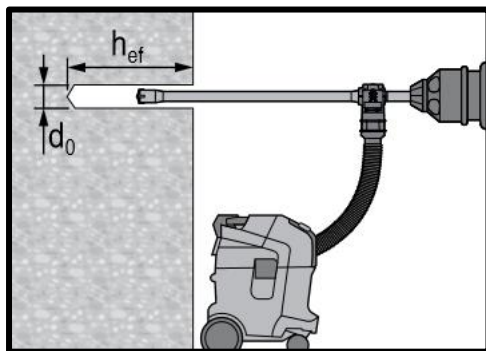

### Hammer drilled hole with Hollow drill bit (HDB)

No cleaning required

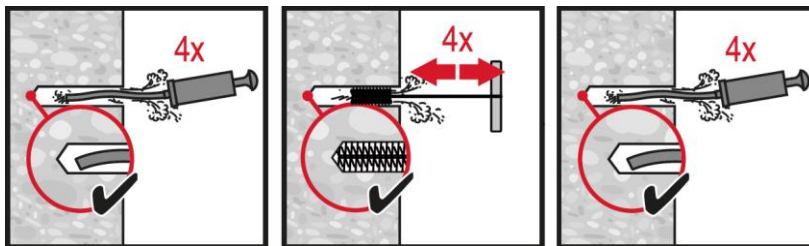

### Manual cleaning (MC)

for drill diameters  $d_0 \leq 20$  mm and drill hole depth  $h_0 \leq 10 \cdot d$  in uncracked concrete.

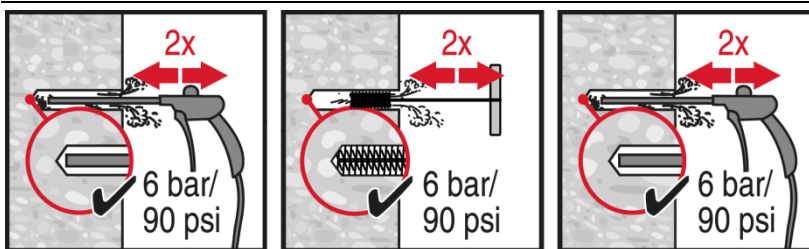

### Compressed air cleaning (CAC)

for all drill hole diameters  $d_0$  and drill hole depths  $h_0 \leq 12 \cdot d$ .

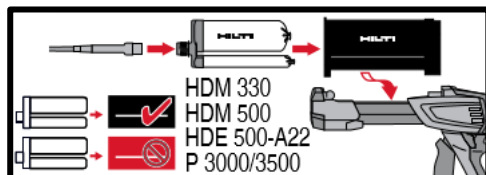

### Injection system preparation.

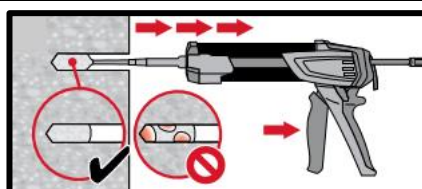
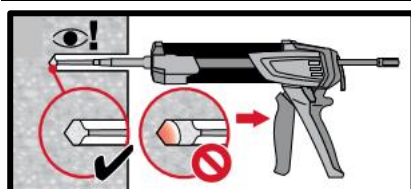
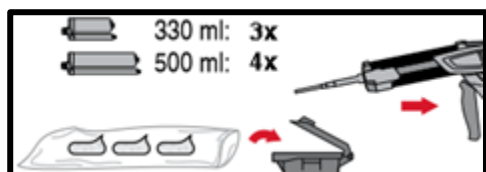

### Injection method for drill hole depth $h_{ef} \leq 250$ mm.

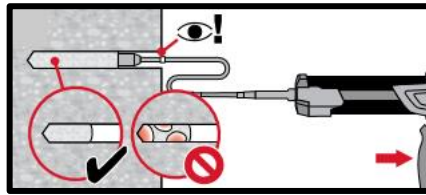
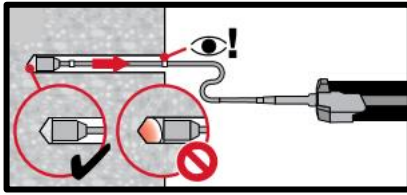

**Injection method** for drill hole depth  $h_{ef} > 250\text{mm}$ .

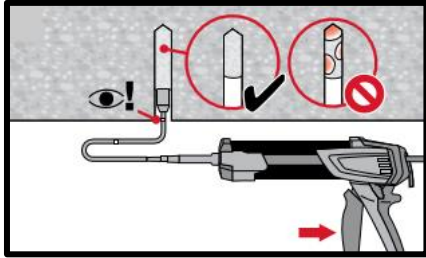
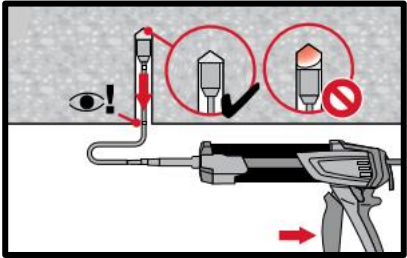

**Injection method** for overhead application.

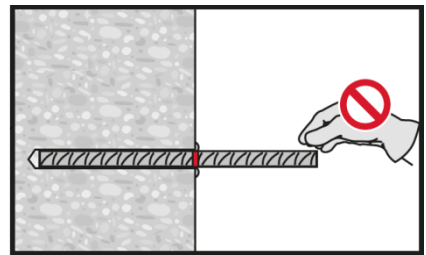
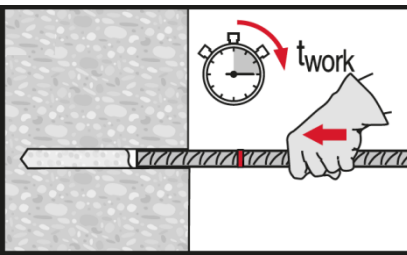

**Setting element**, observe working time "t<sub>work</sub>".

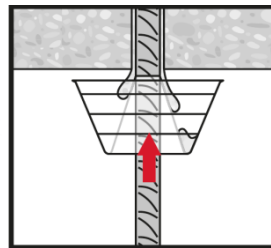
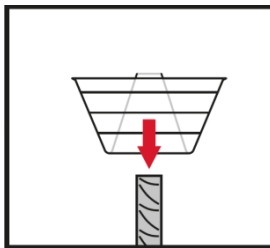
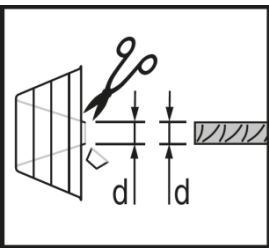

**Setting element** for overhead applications, observe working time "t<sub>work</sub>".

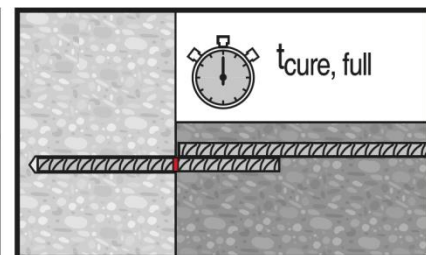
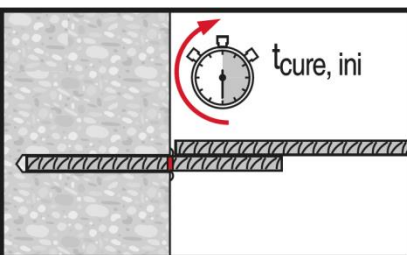
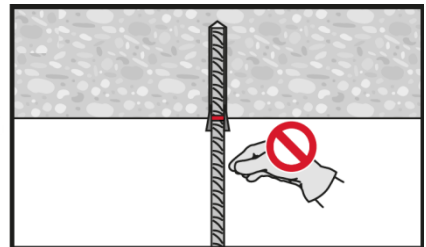
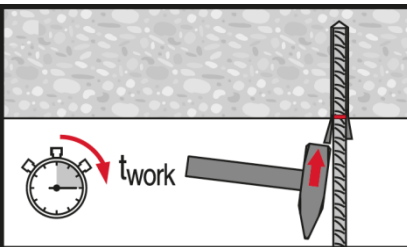

Apply full load only after curing time "t<sub>cure</sub>".

### 2.1.9 HIT-RE 10

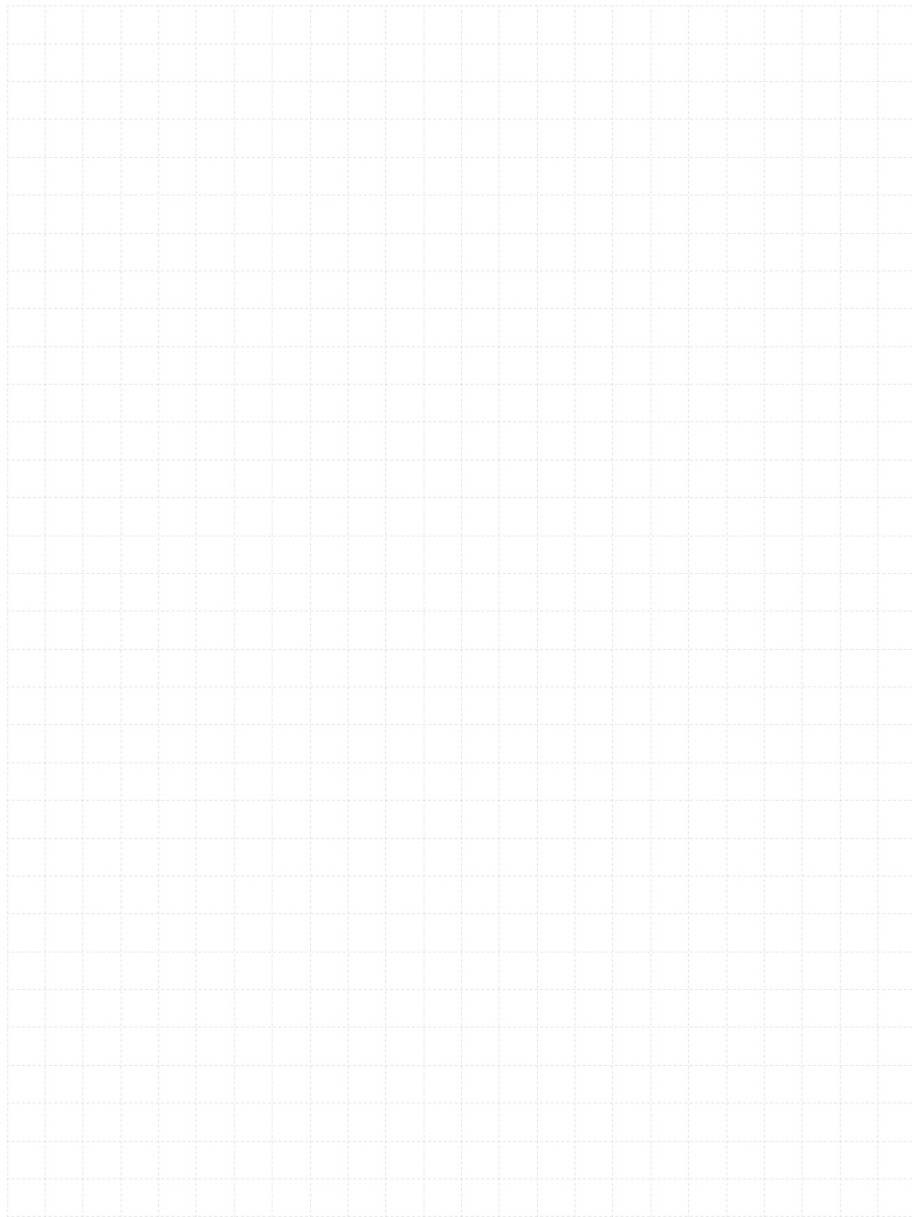

# Hilti HIT-RE 10 injection mortar

## Anchor design (EN 1992-4) / Rods and Sleeves / Concrete

### Injection mortar system



Hilti HIT-RE 10  
580 ml hard  
cartridge



HAS-U  
(M8-M30)

### Benefits

- Suitable for non-cracked concrete C20/25 to C50/60
- Suitable for dry and water saturated concrete
- Suitable for overhead fastenings

### Base material



Concrete  
(non-cracked)



Dry concrete



Wet concrete

### Load conditions

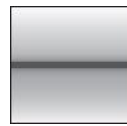

Static/  
quasi-static

### Installation conditions



Hammer  
drilling

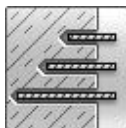

Variable  
embedment  
depth

### Approvals / certificates

Description	Authority / Laboratory	No. / date of issue
Hilti Technical Data <sup>a)</sup>	Hilti	2017-11-28

a) All data given in this section according to Hilti Technical Data

### Static and quasi-static loading (for a single anchor)

#### All data in this section applies to

- Correct setting (see setting instruction)
- No edge distance and spacing influence
- Steel failure
- Base material thickness, as specified in the tables
- Embedment depth, as specified in the tables
- One anchor material, as specified in the tables
- Concrete C20/25,  $f_{ck,cube} = 25 \text{ N/mm}^2$
- In-service temperature range I (min. base material temperature  $-40^\circ\text{C}$ , max. long/short term base material temperature:  $+20^\circ\text{C}/+43^\circ\text{C}$ )

#### Embedment depth <sup>a)</sup> and base material thickness for M8-M12

Anchor size			M8				M10				M12			
Embedment depth <sup>b)</sup>	$h_{ef}$	[mm]	60	80	120	160	60	100	150	200	70	120	180	240
Base material thickness	$h$	[mm]	100	110	150	190	100	130	180	230	100	150	210	270

#### Embedment depth <sup>a)</sup> and base material thickness for M16-M20

Anchor size			M16				M20			
Embedment depth <sup>b)</sup>	$h_{ef}$	[mm]	80	160	240	320	90	200	300	400
Base material thickness	$h$	[mm]	112	192	272	352	130	240	340	440

a) The allowed range of embedment depth is shown in the setting details

b) Recommended loads calculated for embedment depths  $h_{ef} = h_{ef,min}$ ;  $h_{ef} = 10d$ ;  $h_{ef} = 15d$ ;  $h_{ef} = h_{ef,max} = 20d$

#### Recommended loads for M8-M12

Anchor size				M8				M10				M12			
<b>Non-cracked concrete</b>															
Tension	HAS-U 5.8	$N_{rec}$	[kN]	5,1	6,8	8,7	8,7	6,4	10,7	13,8	13,8	9,0	15,4	20,1	20,1
Shear	HAS-U 5.8	$V_{rec}$	[kN]	5,2				8,3				12,0			

#### Recommended loads for M16-M20

Anchor size				M16				M20			
<b>Non-cracked concrete</b>											
Tension	HAS-U 5.8	$N_{rec}$	[kN]	12,0	27,3	37,4	37,4	14,3	42,7	58,3	58,3
Shear	HAS-U 5.8	$V_{rec}$	[kN]	22,4				35,0			



**Materials**
**Mechanical properties**

Anchor size				M8	M10	M12	M16
Nominal tensile strength	HAS-U 5.8	$f_{uk}$	[N/mm <sup>2</sup> ]	500	500	500	500
	HAS-U 8.8			800	800	800	800
	HAS-U-R			700	700	700	700
	HAS-U-HCR			800	800	800	800
Yield strength	HAS-U 5.8	$f_{yk}$	[N/mm <sup>2</sup> ]	400	400	400	400
	HAS-U 8.8			640	640	640	640
	HAS-U-R			450	450	450	450
	HAS-U-HCR			640	640	640	640
Stressed cross-section	HAS-U	$A_s$	[mm <sup>2</sup> ]	36,6	58,0	84,3	157
Moment of resistance	HAS-U	$W$	[mm <sup>3</sup> ]	31,2	62,3	109	277

**Material quality for HAS-U**

Part	Material
<b>Zinc coated steel</b>	
Threaded rod, HAS-U 5.8 (HDG)	Strength class 5.8; Elongation at fracture A5 > 8% ductile Electroplated zinc coated $\geq 5\mu\text{m}$ ; (HDG) hot dip galvanized $\geq 45\mu\text{m}$
Threaded rod, HAS-U 8.8 (HDG)	Strength class 8.8; Elongation at fracture A5 > 12% ductile Electroplated zinc coated $\geq 5\mu\text{m}$ ; (HDG) hot dip galvanized $\geq 45\mu\text{m}$
Washer	Electroplated zinc coated $\geq 5\mu\text{m}$ , hot dip galvanized $\geq 45\mu\text{m}$
Nut	Strength class of nut adapted to strength class of threaded rod. Electroplated zinc coated $\geq 5\mu\text{m}$ , hot dip galvanized $\geq 45\mu\text{m}$
<b>Stainless Steel</b>	
Threaded rod, HAS-U A4	Strength class 70 for M8-M20 Elongation at fracture A5 > 8% ductile Stainless steel 1.4401; 1.4404; 1.4578; 1.4571; 1.4439; 1.4362
Washer	Stainless steel 1.4401, 1.4404, 1.4578, 1.4571, 1.4439, 1.4362 EN 10088-1:2014
Nut	Stainless steel 1.4401, 1.4404, 1.4578, 1.4571, 1.4439, 1.4362 EN 10088-1:2014
<b>High corrosion resistant steel</b>	
Threaded rod, HAS-U HCR	Strength class 80 for M8-M20 Elongation at fracture A5 > 8% ductile High corrosion resistance steel 1.4529; 1.4565;
Washer	High corrosion resistant steel 1.4529, 1.4565 EN 10088-1:2014
Nut	High corrosion resistant steel 1.4529, 1.4565 EN 10088-1:2014

## Setting information

### Installation temperature range:

+5°C to +40°C

### Service temperature range

Hilti HIT-RE 10 injection mortar may be applied in the temperature ranges given below. An elevated base material temperature may lead to a reduction of the design bond resistance.

Temperature range	Base material temperature	Maximum long term base material temperature	Maximum short term base material temperature
Temperature range I	-40 °C to +43 °C	+20 °C	+43 °C
Temperature range II	-40 °C to +55 °C	+43 °C	+55 °C

### Maximum short term base material temperature

Short-term elevated base material temperatures are those that occur over brief intervals, e.g. as a result of diurnal cycling.

### Maximum long term base material temperature

Long-term elevated base material temperatures are roughly constant over significant periods of time.

### Working time and curing time <sup>a)</sup>:

Temperature of the base material	Maximum working time	Minimum curing time
$T_{BM}$	$t_{work}$	$t_{cure}^{a)}$
$5^{\circ}C \leq T_{BM} \leq 10^{\circ}C$	5 h	72 h
$10^{\circ}C < T_{BM} \leq 15^{\circ}C$	2,5 h	48 h
$15^{\circ}C < T_{BM} \leq 20^{\circ}C$	2 h	36 h
$20^{\circ}C < T_{BM} \leq 30^{\circ}C$	60 min	24 h
$30^{\circ}C < T_{BM} \leq 40^{\circ}C$	30 min	12 h

a) The curing time data are valid for dry base material only. In wet base material the curing times must be doubled.

**Setting details**

Anchor size			M8	M10	M12	M16	M20
Nominal diameter of element	d	[mm]	8	10	12	16	20
Nominal diameter of drill bit	d <sub>0</sub>	[mm]	10	12	14	18	24
Maximum diameter of clearance hole in the fixture	d <sub>f</sub>	[mm]	9	12	14	18	22
Minimum base material thickness	h <sub>min</sub>	[mm]	h <sub>ef</sub> + 30 mm ≥ 100 mm			h <sub>ef</sub> + 2d <sub>0</sub>	
Effective anchorage depth (= drill hole depth)	h <sub>ef,min</sub> = h <sub>0</sub>	[mm]	60	60	70	80	90
	h <sub>ef,max</sub> = h <sub>0</sub>	[mm]	160	200	240	320	400
Maximum torque moment	T <sub>max</sub>	[Nm]	10	20	40	80	150
Minimum spacing	s <sub>min</sub>	[mm]	40	50	60	75	90
Minimum edge distance	c <sub>min</sub>	[mm]	40	45	45	50	55





**Installation equipment**

Anchor size		M8	M10	M12	M16	M20
Rotary hammer		TE2(-A) – TE30(-A)				TE40 – TE80
Other tools		Blow out pump (h <sub>ef</sub> ≤ 10·d)				-
		Compressed air gun <sup>b)</sup> Set of cleaning brushes <sup>c)</sup> , dispenser, piston plug				

b) Compressed air gun with extension hose for all drill holes deeper than 250 mm (for M8 to M12) or deeper than 20·φ (for φ > 12 mm)

c) Automatic brushing with round brush for all drill holes deeper than 250 mm (for M8 to M12) or deeper than 20·φ (for φ > 12 mm)

**Parameters of cleaning and setting tools**

HAS-U	Drilling and cleaning		Installation
	Hammer drilling	Brush HIT-RB	Piston plug HIT-SZ
	d <sub>0</sub> [mm]	size [mm]	size [mm]
			
<b>M8</b>	10	10	10
<b>M10</b>	12	12	12
<b>M12</b>	14	14	14
<b>M16</b>	18	18	18
<b>M20</b>	24	24	24
<b>M24</b>	28	28	28
<b>M27</b>	30	30	30
<b>M30</b>	35	35	35

## Setting instructions

\*For detailed information on installation see instruction for use given with the package of the product.



### Safety regulations.

Review the Material Safety Data Sheet (MSDS) before use for proper and safe handling! Wear well-fitting protective goggles and protective gloves when working with Hilti HIT-RE 10.

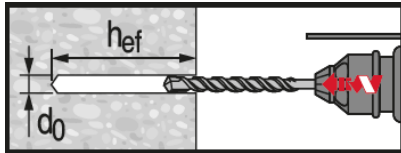

### Hammer drilled hole

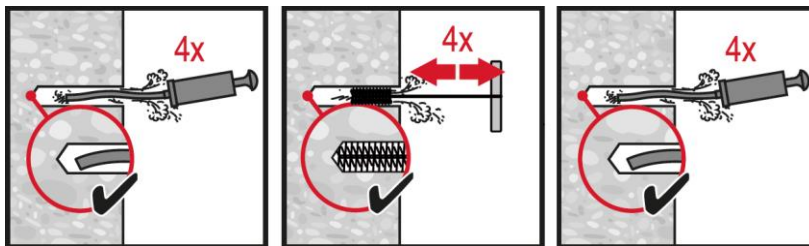

### Manual cleaning (MC)

for drill diameters  $d_0 \leq 20$  mm and drill hole depth  $h_0 \leq 10 \cdot d$ .

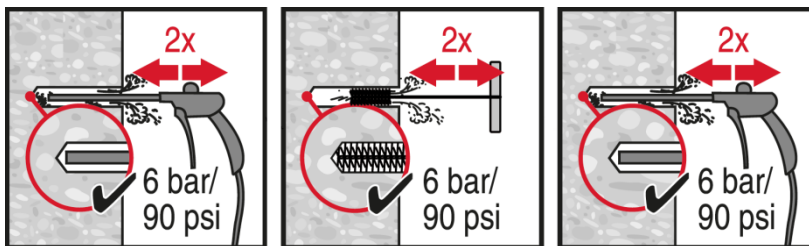

### Compressed air cleaning (CAC)

for all drill hole diameters  $d_0$  and drill hole depths  $h_0 \leq 20 \cdot d$ .

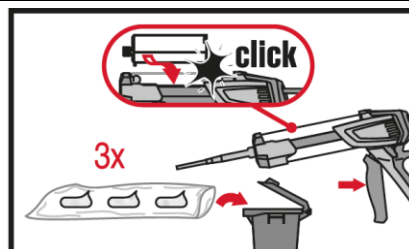
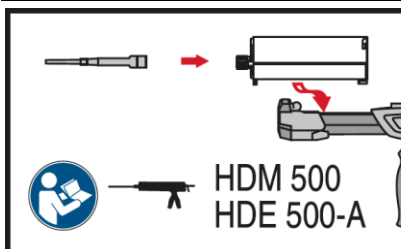

### Injection system preparation.

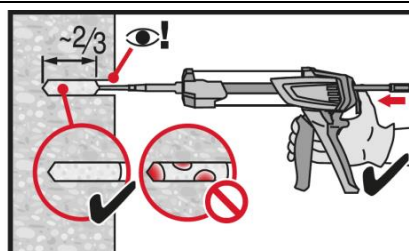
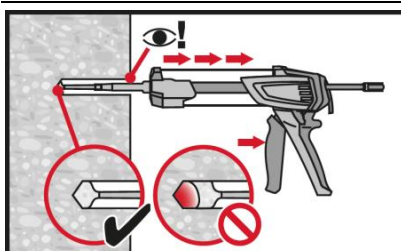

### Injection method for drill hole depth

$h_{ef} \leq 250$  mm.

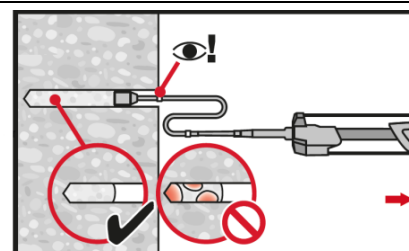
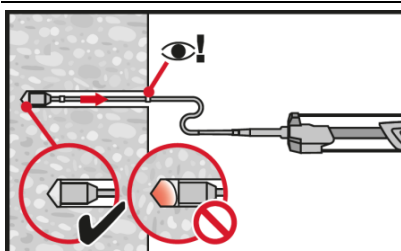

### Injection method for drill hole depth

$h_{ef} > 250$  mm.

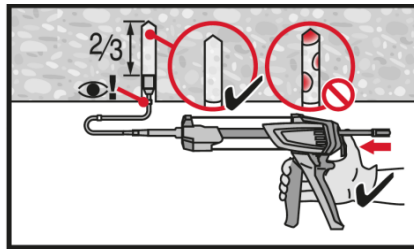
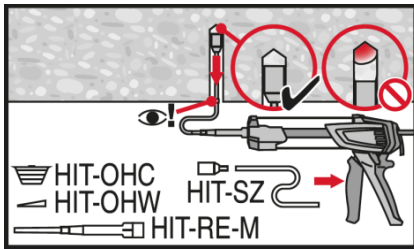

**Injection** method for overhead application.

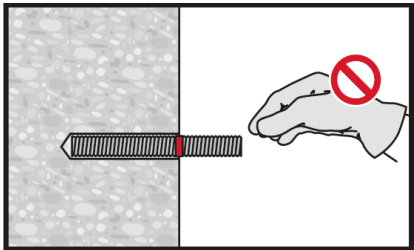
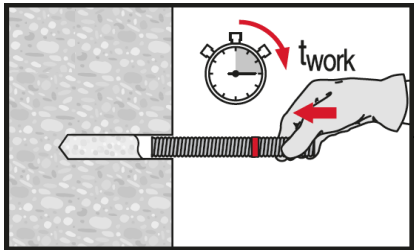

**Setting element**, observe working time " $t_{work}$ ".

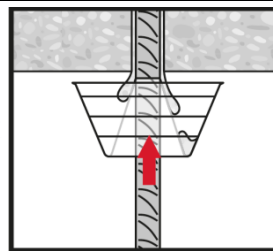
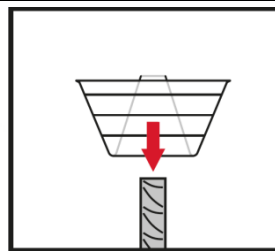
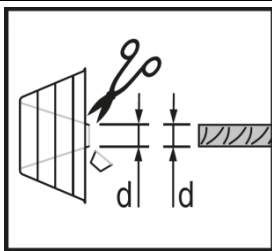

**Setting element** for overhead applications, observe working time " $t_{work}$ ".

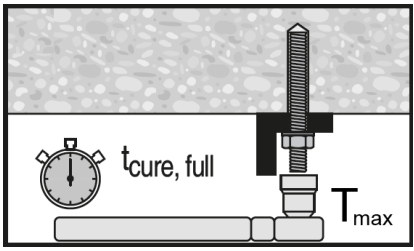
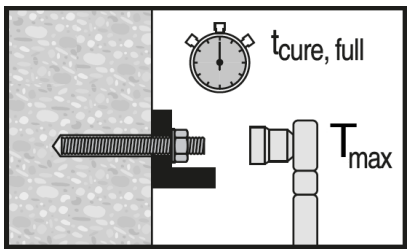
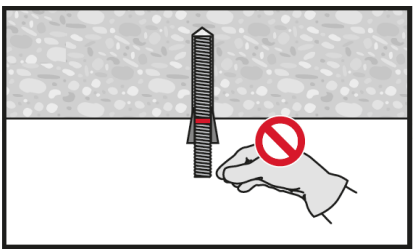
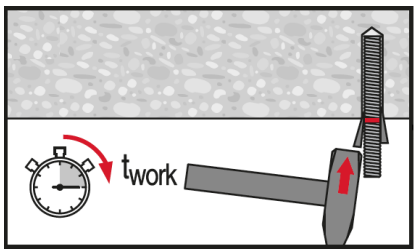

**Apply** full load only after curing time " $t_{cure}$ ", applied installation torque shall not exceed the values  $T_{max}$ .

# HIT-RE 10 injection mortar

Anchor design (EN 1992-4) / Rebar elements / Concrete

## Injection mortar system



Hilti HIT-RE 10  
580 ml hard  
cartridge



Rebar B500 B  
( $\phi 8$  -  $\phi 32$ )

## Benefits

- Suitable for non-cracked concrete C20/25 to C50/60
- Suitable for dry and water saturated concrete
- Suitable for overhead fastenings

## Base material



Concrete  
(non-cracked)



Dry concrete



Wet concrete

## Load condition

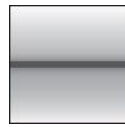

Static/  
quasi-static

## Installation conditions



Hammer  
drilling

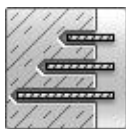

Variable  
embedment  
depth

## Other information



PROFIS  
Engineering  
design  
Software

## Approvals / certificates

Description	Authority / Laboratory	No. / date of issue
Hilti Technical Data <sup>a)</sup>	Hilti	2017-11-28

b) All data given in this section according to Hilti Technical Data

## Static and quasi-static loading (for a single anchor)

### All data in this section applies to

- Correct setting
- No edge distance and spacing influence
- Steel failure
- Base material thickness, as specified in the table
- Embedment depth as specified in the table
- Anchor material, as specified in the tables
- Concrete C20/25,  $f_{ck,cube} = 25 \text{ N/mm}^2$
- In-service temperature range I  
(min. base material temperature  $-40^\circ\text{C}$ , max. long/short term base material temperature:  $+20^\circ\text{C}/+43^\circ\text{C}$ )

### Embedment depth <sup>a)</sup> and base material thickness for d8-d12

Anchor size		$\phi 8$				$\phi 10$				$\phi 12$			
Embedment depth <sup>b)</sup>	$h_{ef}$ [mm]	60	80	120	160	60	100	150	200	70	120	180	240
Base material thickness	$h$ [mm]	100	110	150	190	100	130	180	230	100	150	210	270

### Embedment depth <sup>a)</sup> and base material thickness for d14-d20

Anchor size		$\phi 14$				$\phi 16$				$\phi 20$			
Embedment depth <sup>b)</sup>	$h_{ef}$ [mm]	75	140	210	280	80	160	240	320	90	200	300	400
Base material thickness	$h$ [mm]	103	168	238	308	112	192	272	352	130	240	340	440

a) The allowed range of embedment depth is shown in the setting details

b) Recommended loads calculated for embedment depths  $h_{ef} = h_{ef,min}$ ;  $h_{ef} = 10d$ ;  $h_{ef} = 15d$ ;  $h_{ef} = h_{ef,max} = 20d$

### Recommended loads for d8-d12

Anchor size		$\phi 8$				$\phi 10$				$\phi 12$				
<b>Non-cracked concrete</b>														
Tension	Rebar B500B	$N_{rec}$ [kN]	5,1	6,8	10,3	13,7	6,4	10,7	16,0	21,4	9,0	15,4	23,1	30,8
Shear	Rebar B500B	$V_{rec}$ [kN]	8,0				12,6				17,7			

### Recommended loads for d16-d20

Anchor size		$\phi 14$				$\phi 16$				$\phi 20$				
<b>Non-cracked concrete</b>														
Tension	Rebar B500B	$N_{rec}$ [kN]	10,9	20,9	31,4	41,9	12,0	27,3	41,0	54,7	14,3	42,7	64,1	85,4
Shear	Rebar B500B	$V_{rec}$ [kN]	24,0				31,4				40,0			

## Materials

### Mechanical properties for rebar B500 B

Anchor size			φ8	φ10	φ12	φ14	φ16	φ20
Nominal tensile strength	$f_{uk}$	[N/mm <sup>2</sup> ]	550	550	550	550	550	550
Yield strength	$f_{yk}$	[N/mm <sup>2</sup> ]	500	500	500	500	500	500
Stressed cross-section	$A_s$	[mm <sup>2</sup> ]	50,3	78,5	113,1	153,9	201,1	314,2
Moment of resistance	$W$	[mm <sup>3</sup> ]	50,3	98,2	169,6	269,4	402,1	785,4

### Material quality

Part	Material
Rebar B500 B	Geometry and mechanical properties according to DIN 488-2:1986 or DIN 488-2

## Setting information

### Installation temperature range:

+10°C to +40°C

### Service temperature range

Hilti HIT-RE 10 injection mortar may be applied in the temperature ranges given below. An elevated base material temperature may lead to a reduction of the design bond resistance.

Temperature range	Base material temperature	Maximum long term base material temperature	Maximum short term base material temperature
Temperature range I	-40 °C to + 43 °C	+ 20 °C	+ 43 °C
Temperature range II	- 40 °C to + 55 °C	+ 43 °C	+ 55 °C

### Maximum short term base material temperature

Short term elevated base material temperatures are those that occur over brief intervals, e.g. as a result of diurnal cycling

### Maximum long term base material temperature

Long term elevated base material temperatures are roughly constant over significant periods of time.

### Working time and curing time <sup>a)</sup>

Temperature of the base material	Maximum working time	Minimum curing time
$T_{BM}$	$t_{work}$	$t_{cure}^{a)}$
$5^{\circ}\text{C} \leq T_{BM} \leq 10^{\circ}\text{C}$	5 h	72 h
$10^{\circ}\text{C} < T_{BM} \leq 15^{\circ}\text{C}$	2,5 h	48 h
$15^{\circ}\text{C} < T_{BM} \leq 20^{\circ}\text{C}$	2 h	36 h
$20^{\circ}\text{C} < T_{BM} \leq 30^{\circ}\text{C}$	60 min	24 h
$30^{\circ}\text{C} < T_{BM} \leq 40^{\circ}\text{C}$	30 min	12 h

a) The curing time data are valid for dry base material only. In wet base material, the curing times must be doubled.



**Setting details**

Anchor size		Ø8	Ø10	Ø12	Ø14	Ø16	Ø20
Nominal diameter of element	d [mm]	8	10	12	14	16	20
Nominal diameter of drill bit	d <sub>0</sub> [mm]	10 / 12 <sup>a)</sup>	12 / 14 <sup>a)</sup>	14 / 16 <sup>a)</sup>	18	20	25
Effective anchorage depth (drill hole depth)	h <sub>ef,min</sub> = h <sub>0</sub> [mm]	60	60	70	75	80	90
	h <sub>ef,max</sub> = h <sub>0</sub> [mm]	160	200	240	280	320	400
Minimum base material thickness	h <sub>min</sub> [mm]	h <sub>ef</sub> + 30 mm ≥ 100 mm			h <sub>ef</sub> + 2 · d <sub>0</sub>		
Minimum spacing	s <sub>min</sub> [mm]	40	50	60	70	80	100
Minimum edge distance	c <sub>min</sub> [mm]	40	50	60	70	80	100

a) both given values for drill bit diameter can be used





**Installation equipment**

Anchor size	Ø8	Ø10	Ø12	Ø14	Ø16	Ø20
Rotary hammer	TE 2(-A) – TE 30(-A)					TE 40 – TE 80
Other tools	Blow out pump (h <sub>ef</sub> ≤ 10 · d)					-
	Compressed air gun <sup>a)</sup> Set of cleaning brushes <sup>b)</sup> , dispenser, piston plug					

a) Compressed air gun with extension hose for all drill holes deeper than 250 mm (for φ 8 to φ 12) or deeper than 20 · φ (for φ > 12 mm).

b) Automatic brushing with round brush for all drill holes deeper than 250 mm (for φ 8 to φ 12) or deeper than 20 · φ (for φ > 12 mm).

**Parameters of cleaning and setting tools**

Rebar size	Drilling and cleaning		Installation
	Hammer drilling	Brush HIT-RB	Piston plug HIT-SZ
	d <sub>0</sub> [mm]	size [mm]	size [mm]
			
Ø8	12 (10 <sup>a)</sup> )	12 (10 <sup>a)</sup> )	12 (10 <sup>a)</sup> )
Ø10	14 (12 <sup>a)</sup> )	14 (12 <sup>a)</sup> )	14 (12 <sup>a)</sup> )
Ø12	16 (14 <sup>a)</sup> )	16 (14 <sup>a)</sup> )	16 (14 <sup>a)</sup> )
Ø14	18	18	18
Ø16	20	20	20
Ø20	25	25	25

a) both given values for drill bit diameter can be used

## Setting instructions

\*For detailed information on installation see instruction for use given with the package of the product.



### Safety regulations.

Review the Material Safety Data Sheet (MSDS) before use for proper and safe handling! Wear well-fitting protective goggles and protective gloves when working with Hilti HIT-RE 10

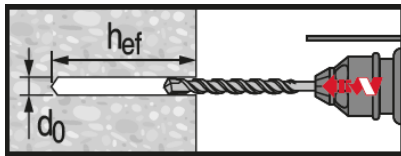

### Hammer drilled hole (HD)

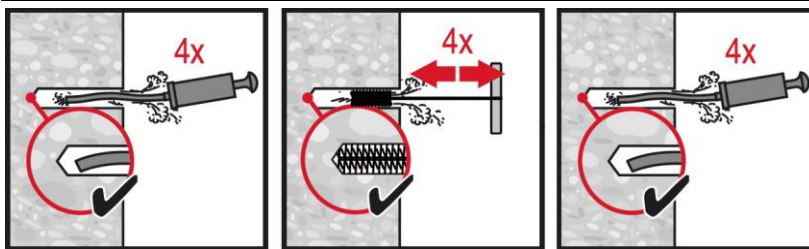

### Manual cleaning (MC)

For element sizes  $d \leq 16\text{mm}$  and embedment depth  $h_{ef} \leq 10d$  only.

Brush bore hole with required steel brush HIT-RB.

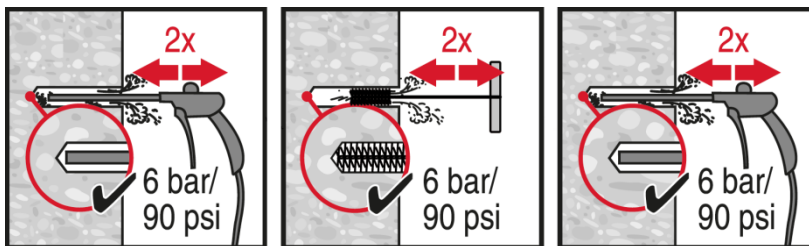

### Compressed air cleaning (CAC)

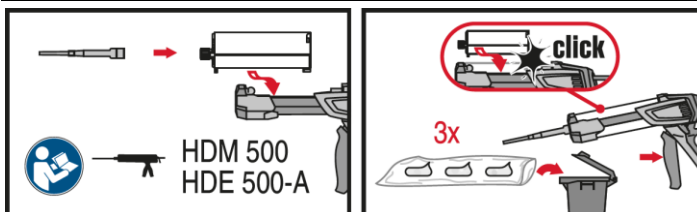

### Injection system preparation.

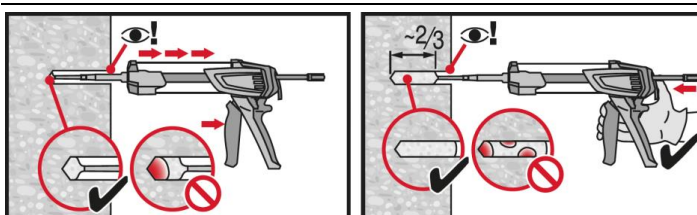

### Injection method for drill hole depth $h_{ef} \leq 250\text{ mm}$ .

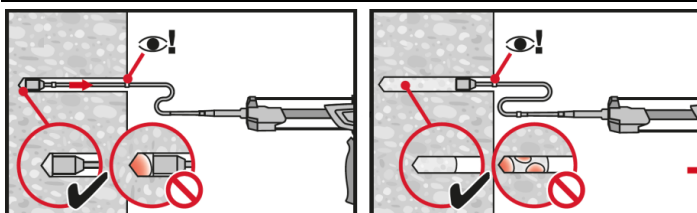

### Injection method for drill hole depth $h_{ef} > 250\text{mm}$ .

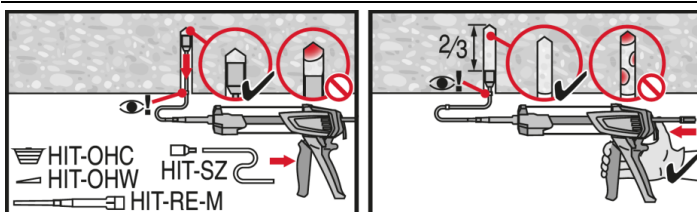

### Injection method for overhead application.

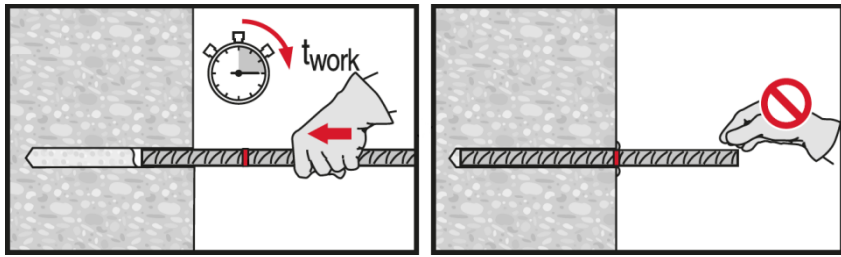

**Setting element**, observe working time " $t_{work}$ ".

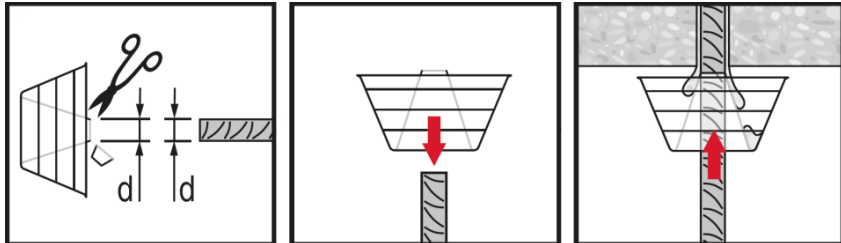

**Setting element** for overhead applications, observe working time " $t_{work}$ ".

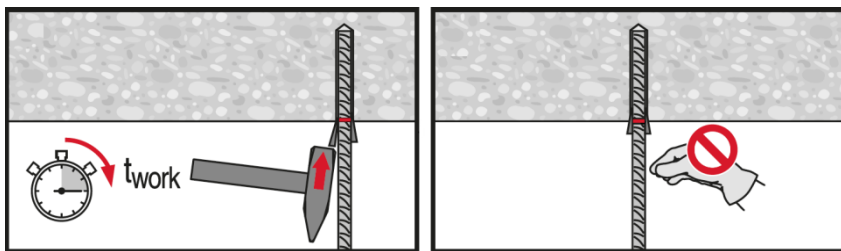

# HIT-RE 10 injection mortar

Rebar design (EN 1992-1) / Rebar elements / Concrete

## Injection mortar system



Hilti HIT-RE 10  
580 ml hard  
cartridges

Rebar B500 B  
( $\phi 8 - \phi 20$ )

## Benefits

- Suitable for non-cracked concrete C20/25 to C50/60
- Suitable for dry and water saturated concrete
- Suitable for overhead fastenings

## Base material



Concrete  
(non-cracked)



Dry concrete



Wet concrete

## Load conditions

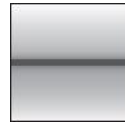

Static/  
quasi-static

## Installation conditions

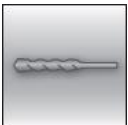

Hammer  
drilling

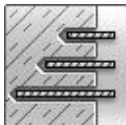

Variable  
embedment  
depth

## Other information



Corrosion  
resistance  
tested

## Approvals / certificates

Description	Authority / Laboratory	No. / date of issue
Hilti Technical Data <sup>a)</sup>	Hilti	2017-11-28

<sup>a)</sup> All data given in this section according to Hilti Technical Data

## Static and quasi-static loading

### Pre-calculated values<sup>1)</sup> – anchorage length

Rebar yield strength  $f_{yk} = 500 \text{ N/mm}^2$ , concrete C25/30, good bond conditions

Rebar-size	Anchorage length	Design value	Mortar volume <sup>2)</sup>		Overlap length	Design value	Mortar volume <sup>2)</sup>
	$l_{bd}$ [mm]	$N_{Rd}$ [kN]	$V_M$ [ml]		$l_o$ [mm]	$N_{Rd}$ [kN]	$V_M$ [ml]
ϕ8	150	10,2	(6) <sup>3)</sup> 12		300	20,4	(11) <sup>3)</sup> 23
	250	17,0	(9) <sup>3)</sup> 19		310	21,0	(11) <sup>3)</sup> 24
	<b>322</b>	<b>21,9</b>	(11) <sup>3)</sup> 24		<b>322</b>	<b>21,9</b>	(11) <sup>3)</sup> 25
ϕ10	181	15,4	(8) <sup>3)</sup> 17		300	25,4	(13) <sup>3)</sup> 28
	310	26,3	(13) <sup>3)</sup> 29		350	29,7	(15) <sup>3)</sup> 32
	<b>403</b>	<b>34,1</b>	(17) <sup>3)</sup> 37		<b>403</b>	<b>34,1</b>	(17) <sup>3)</sup> 37
ϕ12	217	22,1	(11) <sup>3)</sup> 23		300	30,5	(15) <sup>3)</sup> 32
	370	37,7	(19) <sup>3)</sup> 40		400	40,7	(20) <sup>3)</sup> 43
	<b>483</b>	<b>49,2</b>	(24) <sup>3)</sup> 51		<b>483</b>	<b>49,2</b>	(24) <sup>3)</sup> 51
ϕ14	254	30,1	31		315	37,4	39
	350	41,6	43		400	47,5	49
	500	59,4	61		500	59,4	61
ϕ16	290	39,3	40		360	48,9	49
	400	54,3	55		400	54,3	55
	500	67,9	68		500	67,9	68
ϕ20	362	61,5	77		450	76,3	96
	420	71,3	90		470	79,7	100
	500	84,8	107		500	84,8	107

- 1) Values italic letters correspond to the minimum anchorage length. The maximum permissible load (bold letters) is valid for "good bond conditions" as described in EN 1992-1-1. For all other conditions multiply by the value by 0,7.
- 2) Mortar volume according to the equation:  $1,2 \cdot (d_o^2 - d_s^2) \cdot \pi \cdot l_{bd} / 4$ .
- 3) Value of mortar volume corresponds with minimal nominal diameter of drill bit (see table "Installation equipment").

## Materials

### Material quality

Designation	Material
Reinforcing bars (rebars)	
Rebar EN 1992-1-1	Bars and de-coiled rods class B or C with $f_{yk}$ and $k$ according to NDP or NCL of EN 1992-1-1 $f_{uk} = f_{tk} = k \cdot f_{yk}$

### Fitness for use

Creep tests have been conducted in accordance with EAD 330087-00-0601 and TR 023 in the following conditions: **in dry environment at 43 °C during 90 days.**

These tests show an excellent behaviour of the post-installed connection made with HIT-RE 10: low displacements

### Durability of Hilti-RE 10 injection mortar:

Condition	Comment	Resistance
Sulphurous atmosphere	23°C	+
High alkalinity	pH = 13,2, 23°C	+

### Corrosion resistance of post-installed rebar:

Post-installed rebar connections made with Hilti-RE 10 injection mortar provide the same corrosion resistance as a cast-in-place rebar.

## Setting information

### Installation temperature range:

+5°C to +40°C

### Service temperature range

Hilti HIT-RE 10 injection mortar may be applied in the temperature ranges given below. An elevated base material temperature may lead to a reduction of the design bond resistance.

Temperature range	Base material temperature	Maximum long term base material temperature	Maximum short term base material temperature
Temperature range I	-40 °C to +43 °C	+20 °C	+43 °C

### Maximum short term base material temperature

Short-term elevated base material temperatures are those that occur over brief intervals, e.g. as a result of diurnal cycling.

### Maximum long term base material temperature

Long-term elevated base material temperatures are roughly constant over significant periods of time.

### Working time and curing time <sup>a)</sup>

Temperature of the base material	Maximum working time	Initial curing time	Minimum curing time
$T_{BM}$	$t_{work}$	$t_{cure,ini}^{a)}$	$t_{cure}^{a)}$
$5^{\circ}\text{C} \leq T_{BM} \leq 10^{\circ}\text{C}$	5 h	30 h	72 h
$10^{\circ}\text{C} < T_{BM} \leq 15^{\circ}\text{C}$	2,5 h	20 h	48 h
$15^{\circ}\text{C} < T_{BM} \leq 20^{\circ}\text{C}$	2 h	15 h	36 h
$20^{\circ}\text{C} < T_{BM} \leq 30^{\circ}\text{C}$	60 min	10 h	24 h
$30^{\circ}\text{C} < T_{BM} \leq 40^{\circ}\text{C}$	30 min	5 h	12 h

a) The curing time data are valid for dry anchorage base material only. For wet base materials the curing times must be doubled.

**Installation equipment**

Rebar - size	Ø8	Ø10	Ø12	Ø14	Ø16	Ø20
Rotary hammer	TE 2(-A) – TE 30(-A)					TE 40 – TE 80
Other tools	Blow out pump ( $h_{ef} \leq 10 \cdot d$ )					-
	Compressed air gun <sup>b)</sup> Set of cleaning brushes <sup>c)</sup> , dispenser, piston plug					

a) Both given drill bit diameter can be used.

b) Compressed air gun with extension hose for all drill holes deeper than 250 mm (for  $\phi$  8 to  $\phi$  12) or deeper than  $20 \cdot \phi$  (for  $\phi > 12$  mm).

c) Automatic brushing with round brush for all drill holes deeper than 250 mm (for  $\phi$  8 to  $\phi$  12) or deeper than  $20 \cdot \phi$  (for  $\phi > 12$  mm).

**Minimum concrete cover  $c_{min}$  of the post-installed rebar**

Drilling method	Rebar – size [mm]	Minimum concrete cover $c_{min}$ [mm]		
		Without drilling aid	With drilling aid	
Hammer drilling	$\phi < 25$	$30 + 0,06 \cdot l_v \geq 2 \cdot \phi$	$30 + 0,02 \cdot l_v \geq 2 \cdot \phi$	

**Dispenser and corresponding maximum embedment depth  $l_{v,max}$** 

Rebar – size [mm]	Dispenser (HDM 500, HDE 500-A)	
	$l_{v,max}$ [mm]	
$\phi 8 - \phi 20$	500	

**Parameters of cleaning and setting tools**

Rebar size	Drilling and cleaning		Installation
	Hammer drilling	Brush HIT-RB	Piston plug HIT-SZ
	$d_0$ [mm]	size [mm]	size [mm]
Ø8	12 (10 <sup>a)</sup> )	12 (10 <sup>a)</sup> )	12 (10 <sup>a)</sup> )
Ø10	14 (12 <sup>a)</sup> )	14 (12 <sup>a)</sup> )	14 (12 <sup>a)</sup> )
Ø12	16 (14 <sup>a)</sup> )	16 (14 <sup>a)</sup> )	16 (14 <sup>a)</sup> )
Ø14	18	18	18
Ø16	20	20	20
Ø20	25	25	25

## Setting instructions

\*For detailed information on installation see instruction for use given with the package of the product.



### Safety regulations.

Review the Material Safety Data Sheet (MSDS) before use for proper and safe handling! Wear well-fitting protective goggles and protective gloves when working with Hilti HIT-RE 10.

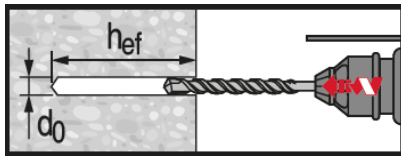

### Hammer drilled hole

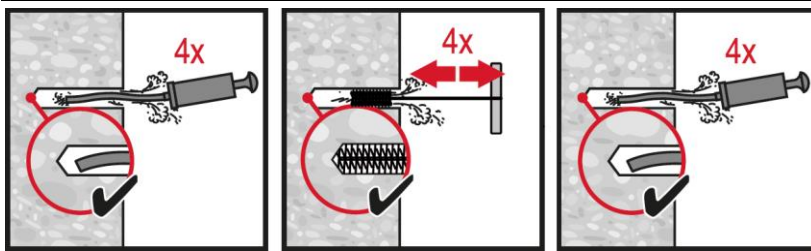

### Manual cleaning (MC)

for drill diameters  $d_0 \leq 20$  mm and drill hole depth  $h_0 \leq 10 \cdot d$ .

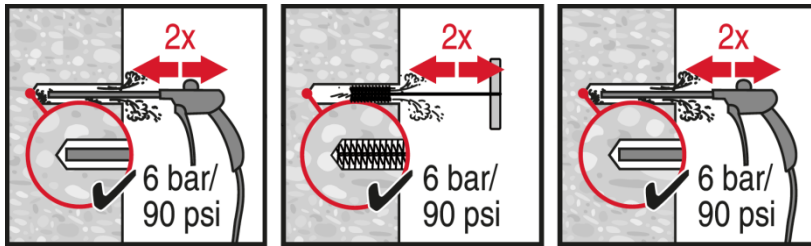

### Compressed air cleaning (CAC)

for all drill hole diameters  $d_0$  and drill hole depths  $h_0 \leq 20 \cdot d$ .

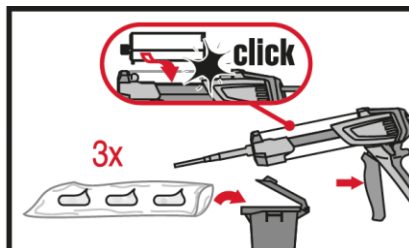
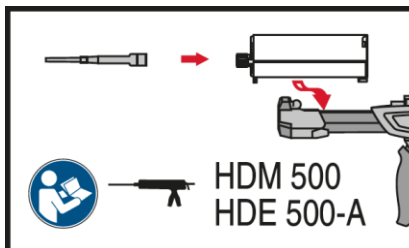

### Injection system preparation.

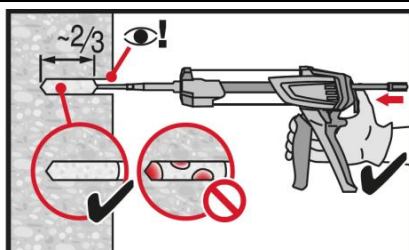
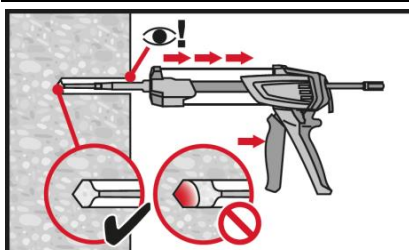

### Injection method for drill hole depth

$h_{ef} \leq 250$  mm.

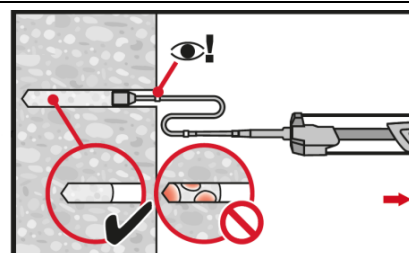
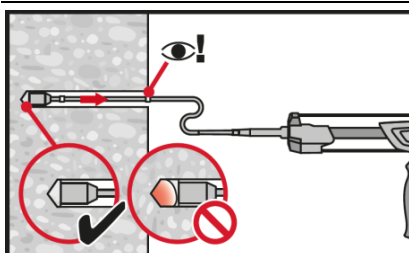

### Injection method for drill hole depth

$h_{ef} > 250$  mm.



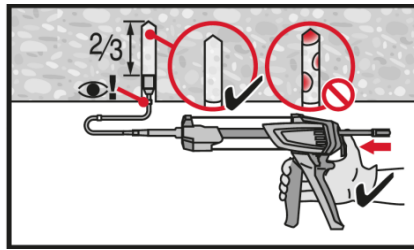
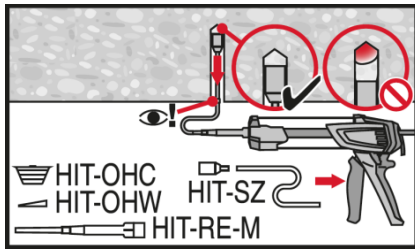

**Injection method for overhead application.**

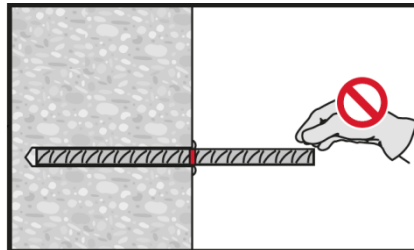
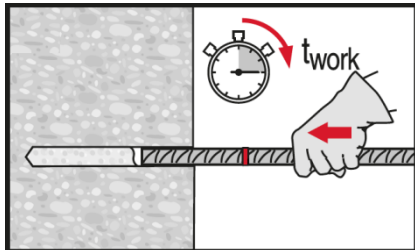

**Setting element, observe working time "t<sub>work</sub>".**

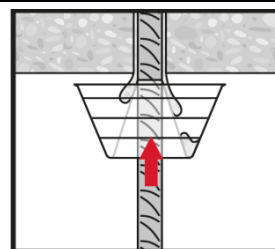
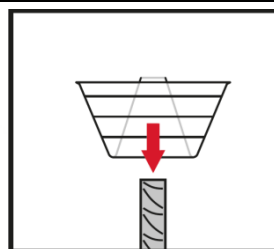
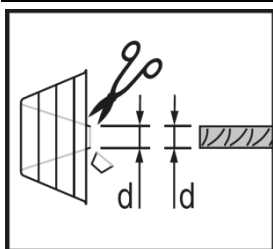

**Setting element for overhead applications, observe working time "t<sub>work</sub>".**

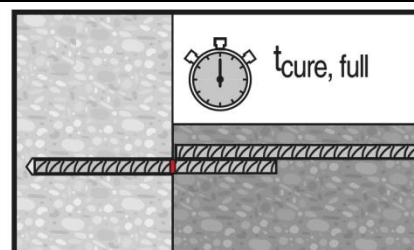
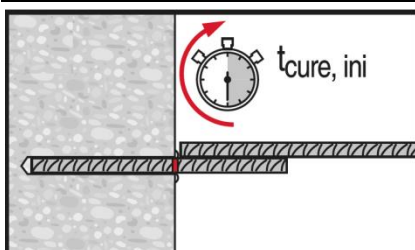
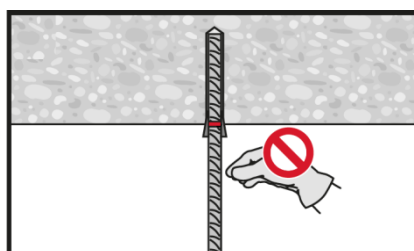
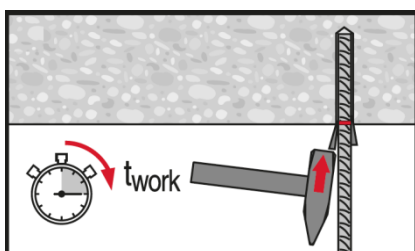



**Apply full load only after curing time "t<sub>cure</sub>".**

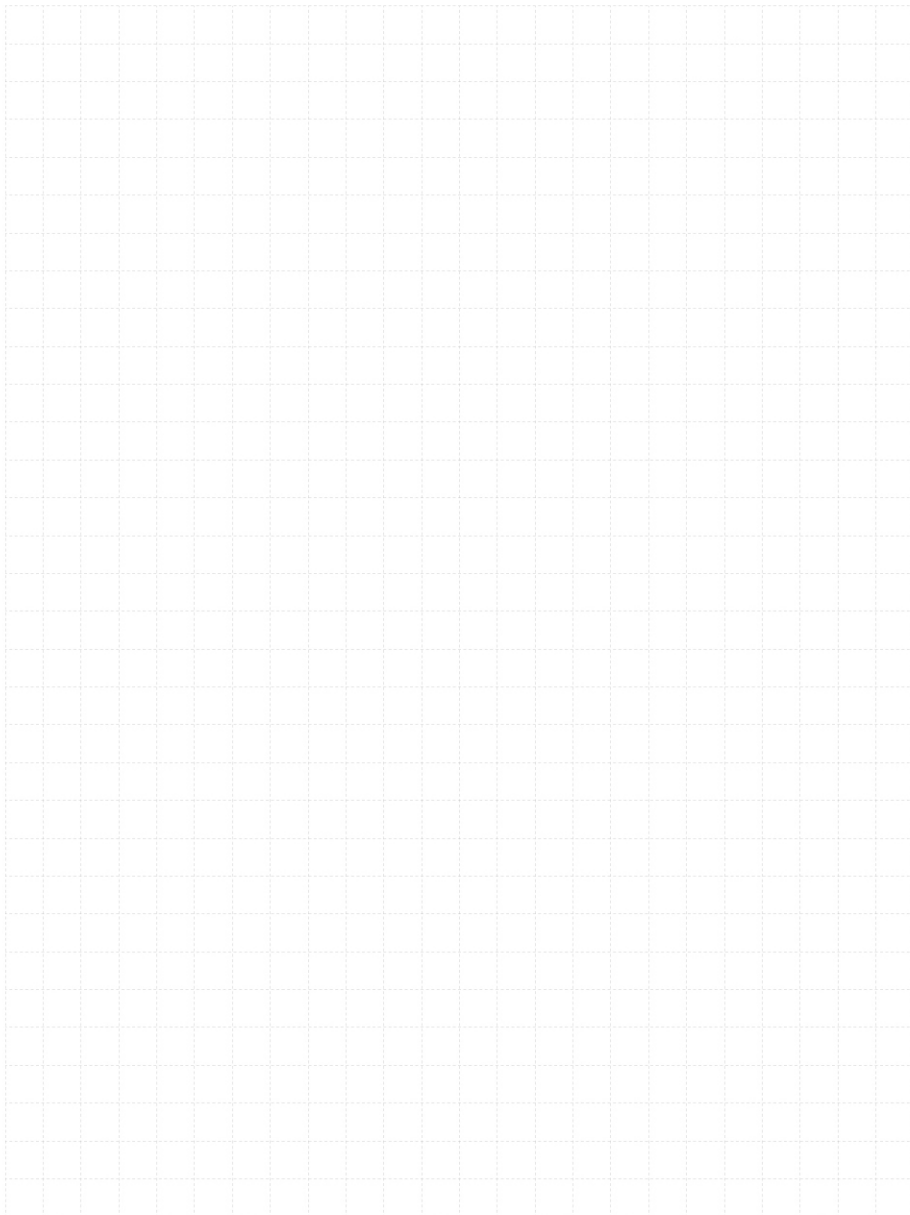





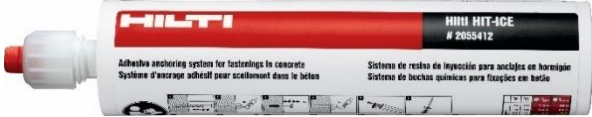



## 2.1.10 HIT-ICE

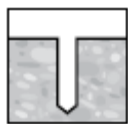

# HIT-ICE injection mortar

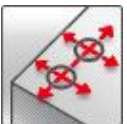
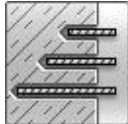
## Anchor design (EN 1992-4) / Rods and Sleeves / Concrete

Injection mortar system	Benefits
   <p>Hilti HIT-ICE 296 ml cartridge</p> <p>Anchor rods: HAS-U HAS-U HDG HAS-U A4 HAS-U HCR (M8-M24)</p> <p>Internally threaded sleeve: HIS-N HIS-R-N sleeves (M8-M20)</p>	<ul style="list-style-type: none"> <li>- Suitable for cracked <sup>a)</sup> and non-cracked concrete C 20/25 to C 50/60</li> <li>- High loading capacity</li> <li>- Suitable for dry and water saturated concrete</li> <li>- High corrosion <sup>a)</sup> / corrosion resistant</li> <li>- Odourless resin</li> <li>- Low installation temperature</li> </ul>

Base material	Load conditions
    <p>Concrete (non-cracked)</p> <p>Concrete <sup>a)</sup> (cracked)</p> <p>Dry concrete</p> <p>Wet concrete</p>	 <p>Static/ quasi-static</p>
Installation conditions	Other information
   <p>Hammer drilled holes</p> <p>Small edge distance and spacing</p> <p>Variable embedment depth</p>	   <p>PROFIS Engineering design Software</p> <p>Corrosion resistance</p> <p>High corrosion resistance <sup>a)</sup></p>

a) Applications only for HAS-U rods.

### Approvals / certificates

Description	Authority / Laboratory	No. / date of issue
Hilti Technical Data <sup>a)</sup>	Hilti	2017-11-28

a) All data given in this section according to Hilti Technical Data.

**Static and quasi-static loading (for a single anchor)**
**All data in this section applies to**

- Correct setting (See setting instruction)
- No edge distance and spacing influence
- Steel failure
- Base material thickness, as specified in the table
- Embedment depth as specified in the table
- Anchor material as specified in the tables
- Concrete C 20/25,  $f_{ck,cube} = 25 \text{ N/mm}^2$
- In-service temperature range I  
(min. base material temperature  $-40^\circ\text{C}$ , max. long/short term base material temperature:  $+24^\circ\text{C}/+40^\circ\text{C}$ )

**Embedment depth <sup>a)</sup> and base material thickness**

Anchor size		M8	M10	M12	M16	M20	M24
<b>HIT-V</b>							
Embedment depth	$h_{ef}$ [mm]	80	90	110	125	170	210
Base material thickness	$h$ [mm]	110	120	140	165	220	270
<b>HIS-N</b>							
Embedment depth	$h_{ef}$ [mm]	90	110	125	170	205	-
Base material thickness	$h$ [mm]	120	150	170	230	270	-

a) The allowed range of embedment depth is shown in the setting details

**Characteristic resistance**

Anchor size		M8	M10	M12	M16	M20	M24	
<b>Non-cracked concrete</b>								
Tension	HAS-U 5.8	$N_{Rk}$ [kN]	18,3	29,0	42,2	65,9	96,1	142,4
	HAS-U 8.8		21,1	29,7	43,5	65,9	96,1	142,4
	HAS-U A4		21,1	29,7	43,5	65,9	96,1	142,4
	HAS-U HCR		21,1	29,7	43,5	65,9	96,1	142,4
	HIS-N 8.8		25,0	42,8	56,4	88,2	88,9	-
Shear	HAS-U 5.8	$V_{Rk}$ [kN]	9,2	14,5	21,1	39,3	61,3	88,3
	HAS-U 8.8		14,6	23,2	33,7	62,8	98,0	141,2
	HAS-U A4		12,8	20,3	29,5	55,0	85,8	123,6
	HAS-U HCR		14,6	23,2	33,7	62,8	98,0	123,6
	HIS-N 8.8		13,0	23,0	34,0	63,0	58,0	-
<b>Cracked concrete</b>								
Tension	HAS-U 5.8	$N_{Rk}$ [kN]	-	-	20,7	25,1	32,0	-
	HAS-U 8.8		-	-	20,7	25,1	32,0	-
	HAS-U A4		-	-	20,7	25,1	32,0	-
	HAS-U HCR		-	-	20,7	25,1	32,0	-
Shear	HAS-U 5.8	$V_{Rk}$ [kN]	-	-	21,1	39,3	61,3	-
	HAS-U 8.8		-	-	33,7	50,2	64,1	-
	HAS-U A4		-	-	29,5	50,2	64,1	-
	HAS-U HCR		-	-	33,7	50,2	64,1	-

**Design resistance**

Anchor size		M8	M10	M12	M16	M20	M24	
<b>Non-cracked concrete</b>								
Tension	HAS-U 5.8	N <sub>Rd</sub> [kN]	11,7	16,5	24,2	36,6	53,4	79,1
	HAS-U 8.8		11,7	16,5	24,2	36,6	53,4	79,1
	HAS-U A4		11,7	16,5	24,2	36,6	53,4	79,1
	HAS-U HCR		11,7	16,5	24,2	36,6	53,4	79,1
	HIS-N 8.8		16,7	28,5	37,6	58,8	59,3	-
Shear	HAS-U 5.8	V <sub>Rd</sub> [kN]	7,3	11,6	16,9	31,4	49,0	70,6
	HAS-U 8.8		11,7	18,6	27,0	50,2	78,4	113,0
	HAS-U A4		8,2	13,0	18,9	35,2	55,0	79,2
	HAS-U HCR		11,7	18,6	27,0	50,2	78,4	70,6
	HIS-N 8.8		10,4	18,4	27,2	50,4	46,4	-
<b>Cracked concrete</b>								
Tension	HAS-U 5.8	N <sub>Rd</sub> [kN]	-	-	11,5	14,0	17,8	-
	HAS-U 8.8		-	-	11,5	14,0	17,8	-
	HAS-U A4		-	-	11,5	14,0	17,8	-
	HAS-U HCR		-	-	11,5	14,0	17,8	-
Shear	HAS-U 5.8	V <sub>Rd</sub> [kN]	-	-	16,9	31,4	42,7	-
	HAS-U 8.8		-	-	27,0	33,5	42,7	-
	HAS-U A4		-	-	18,9	33,5	42,7	-
	HAS-U HCR		-	-	27,0	33,5	42,7	-

**Recommended loads**

Anchor size		M8	M10	M12	M16	M20	M24	
<b>Non-cracked concrete</b>								
Tension	HAS-U 5.8	N <sub>Rec</sub> [kN]	8,4	11,8	17,3	26,2	38,1	56,5
	HAS-U 8.8		8,4	11,8	17,3	26,2	38,1	56,5
	HAS-U A4		8,4	11,8	17,3	26,2	38,1	56,5
	HAS-U HCR		8,4	11,8	17,3	26,2	38,1	56,5
	HIS-N 8.8		11,9	20,4	26,8	42,0	42,3	-
Shear	HAS-U 5.8	V <sub>Rec</sub> [kN]	5,2	8,3	12,0	22,4	35,0	50,4
	HAS-U 8.8		8,4	13,3	19,3	35,9	56,0	80,7
	HAS-U A4		5,9	9,3	13,5	25,2	39,3	56,6
	HAS-U HCR		8,4	13,3	19,3	35,9	56,0	50,4
	HIS-N 8.8		7,4	13,1	19,4	36,0	33,1	-
<b>Cracked concrete</b>								
Tension	HAS-U 5.8	N <sub>Rec</sub> [kN]	-	-	8,2	10,0	12,7	-
	HAS-U 8.8		-	-	8,2	10,0	12,7	-
	HAS-U A4		-	-	8,2	10,0	12,7	-
	HAS-U HCR		-	-	8,2	10,0	12,7	-
Shear	HAS-U 5.8	V <sub>Rec</sub> [kN]	-	-	12,0	22,4	30,5	-
	HAS-U 8.8		-	-	19,3	23,9	30,5	-
	HAS-U A4		-	-	13,5	23,9	30,5	-
	HAS-U HCR		-	-	19,3	23,9	30,5	-

a) With overall partial safety factor for action  $\gamma=1,4$ . The partial safety factors for action depend on the type of loading and shall be taken from national regulations.

**Materials**
**Mechanical properties for HAS-U**

Anchor size				M8	M10	M12	M16
Nominal tensile strength	HAS-U 5.8	$f_{uk}$	[N/mm <sup>2</sup> ]	500	500	500	500
	HAS-U 8.8			800	800	800	800
	HAS-U-R			700	700	700	700
	HAS-U-HCR			800	800	800	800
Yield strength	HAS-U 5.8	$f_{yk}$	[N/mm <sup>2</sup> ]	400	400	400	400
	HAS-U 8.8			640	640	640	640
	HAS-U-R			450	450	450	450
	HAS-U-HCR			640	640	640	640
Stressed cross-section	HAS-U	$A_s$	[mm <sup>2</sup> ]	36,6	58,0	84,3	157
Moment of resistance	HAS-U	$W$	[mm <sup>3</sup> ]	31,2	62,3	109	277

**Material quality for HAS-U**

Part	Material
<b>Zinc coated steel</b>	
Threaded rod, HAS-U 5.8 (HDG)	Strength class 5.8; Elongation at fracture A5 > 8% ductile Electroplated zinc coated $\geq 5\mu\text{m}$ ; (HDG) hot dip galvanized $\geq 45\mu\text{m}$
Threaded rod, HAS-U 8.8 (HDG)	Strength class 8.8; Elongation at fracture A5 > 12% ductile Electroplated zinc coated $\geq 5\mu\text{m}$ ; (HDG) hot dip galvanized $\geq 45\mu\text{m}$
Washer	Electroplated zinc coated $\geq 5\mu\text{m}$ , hot dip galvanized $\geq 45\mu\text{m}$
Nut	Strength class of nut adapted to strength class of threaded rod. Electroplated zinc coated $\geq 5\mu\text{m}$ , hot dip galvanized $\geq 45\mu\text{m}$
<b>Stainless Steel</b>	
Threaded rod, HAS-U A4	Strength class 70 for M8-M24 Elongation at fracture A5 > 8% ductile Stainless steel 1.4401; 1.4404; 1.4578; 1.4571; 1.4439; 1.4362
Washer	Stainless steel 1.4401, 1.4404, 1.4578, 1.4571, 1.4439, 1.4362 EN 10088-1:2014
Nut	Stainless steel 1.4401, 1.4404, 1.4578, 1.4571, 1.4439, 1.4362 EN 10088-1:2014
<b>High corrosion resistant steel</b>	
Threaded rod, HAS-U HCR	Strength class 80 for M8-M20 and class 70 for M24 Elongation at fracture A5 > 8% ductile High corrosion resistance steel 1.4529; 1.4565;
Washer	High corrosion resistant steel 1.4529, 1.4565 EN 10088-1:2014
Nut	High corrosion resistant steel 1.4529, 1.4565 EN 10088-1:2014

**Mechanical properties for HIS-N**

Anchor size			M8	M10	M12	M16	M20
Nominal tensile strength	HIS-N	$f_{uk}$ [N/mm <sup>2</sup> ]	490	460	460	460	460
	Screw 8.8		800	800	800	800	800
	HIS-RN		700	700	700	700	700
	Screw A4-70		700	700	700	700	700
Yield strength	HIS-N	$f_{yk}$ [N/mm <sup>2</sup> ]	410	375	375	375	375
	Screw 8.8		640	640	640	640	640
	HIS-RN		350	350	350	350	350
	Screw A4-70		450	450	450	450	450
Stressed cross-section	HIS-(R)N	$A_s$ [mm <sup>2</sup> ]	51,5	237,6	169	256	237,6
	Screw		36,6	245	84,3	157	245
Moment of resistance	HIS-(R)N	$W$ [mm <sup>3</sup> ]	145	1543	840	1595	1543
	Screw		31,2	541	109	277	541

**Material quality for HIS-N**

Part	Material
HIS-N	Internal threaded sleeve
	Screw 8.8
HIS-RN	Internal threaded sleeve
	Screw 70

## Setting information

### Installation temperature range:

-23°C to +32°C

### In service temperature range

Hilti HIT-ICE injection mortar may be applied in the temperature ranges given below. An elevated base material temperature may lead to a reduction of the design bond resistance.

### Temperature in base material

Temperature range	Base material temperature	Maximum long term base material temperature	Maximum short term base material temperature
Temperature range I	-40 °C to + 40 °C	+ 24 °C	+ 40 °C
Temperature range II	-40 °C to + 54 °C	+ 43 °C	+ 54°C

### Maximum short term base material temperature

Short term elevated base material temperatures are those that occur over brief intervals, e.g. as a result of diurnal cycling.

### Maximum long term base material temperature

Long term elevated base material temperatures are roughly constant over significant periods of time.

### Working time and curing time <sup>a)</sup>

Temperature of the base material	Maximum working time	Minimum curing time
$T_{BM}$	$t_{work}$	$t_{cure}$
-23 °C	1,5 h	36 h
-18 °C	1,5 h	24 h
-7 °C	1 h	6 h
4 °C	15 min	1,5 h
16 °C	5 min	1 h
21 °C	2,5 min	45 min
32 °C	1 min	35 min

a) The curing time data are valid for dry base material only. In wet base material the curing times must be doubled



**Setting details**

Anchor size			M8	M10	M12	M16	M20	M24
Nominal diameter of element	d	[mm]	8	10	12	16	20	24
Nominal diameter of drill bit	d <sub>0</sub>	[mm]	10	12	14	18	24	28
Maximum diameter of clearance hole in the fixture	d <sub>f</sub>	[mm]	9	12	14	18	22	26
Effective anchorage depth (= drill hole depth)	h <sub>ef,min</sub> = h <sub>0</sub>	[mm]	60	60	70	80	90	96
	h <sub>ef,max</sub> = h <sub>0</sub>	[mm]	160	200	240	320	400	480
Minimum base material thickness <sup>a)</sup>	h <sub>min</sub>	[mm]	h <sub>ef</sub> + 30 mm ≥ 100 mm			h <sub>ef</sub> + 2d <sub>0</sub>		
Maximum torque moment	T <sub>max</sub>		10	20	40	80	150	200
Minimum spacing	s <sub>min</sub>	[mm]	40	50	60	80	100	120
Minimum edge distance	c <sub>min</sub>	[mm]	40	45	45	50	55	60
Critical spacing for splitting failure	s <sub>cr,sp</sub>	[mm]	2 c <sub>cr,sp</sub>					
Critical edge distance for splitting failure <sup>b)</sup>	c <sub>cr,sp</sub>	[mm]	1,0 · h <sub>ef</sub> for h / h <sub>ef</sub> ≥ 2,0					
			4,6 h <sub>ef</sub> - 1,8 h for 2,0 > h / h <sub>ef</sub> > 1,3					
			2,26 h <sub>ef</sub> for h / h <sub>ef</sub> ≤ 1,3					
Critical spacing for concrete cone failure	s <sub>cr,N</sub>	[mm]	2 c <sub>cr,N</sub>					
Critical edge distance for concrete cone failure <sup>b)</sup>	c <sub>cr,N</sub>	[mm]	1,5 h <sub>ef</sub>					

For spacing (edge distance) smaller than critical spacing (critical edge distance) the design loads have to be reduced.



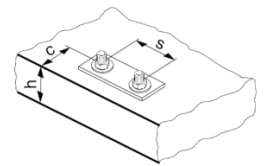

- h: base material thickness ( $h \geq h_{min}$ )
- The critical edge distance for concrete cone failure depends on the embedment depth  $h_{ef}$  and the design bond resistance. The simplified formula given in this table is on the safe side.
- This is the maximum recommended torque moment to avoid splitting failure during installation for anchors with minimum spacing and / or edge distance.



**Installation equipment**

Anchor size		M8	M10	M12	M16	M20	M24
Rotary hammer	HAS-U	TE 2 – TE 30			TE 40 – TE 70		
	HIS-N	TE 2 – TE 30	TE 40 – TE 70		-		
Other tools		Blow out pump ( $h_{ef} \leq 10 \cdot d$ ), Compressed air gun, Set of cleaning brushes, dispenser, piston plug					

**Parameters of cleaning and setting tools**

HAS-U	HIS-N	Drilling and cleaning		Installation
		Hammer drill (HD)	Brush HIT-RB	Piston plug HIT-SZ
		$d_0$ [mm]	size [mm]	size [mm]
				
<b>M8</b>	-	10	10	10
<b>M10</b>	-	12	12	12
<b>M12</b>	<b>M8</b>	14	14	14
<b>M16</b>	<b>M10</b>	18	18	18
-	<b>M12</b>	22	22	22
<b>M20</b>	-	24	24	24
<b>M24</b>	<b>M16</b>	28	28	28
-	<b>M20</b>	32	32	32

## Setting instructions

\*For detailed information on installation see instruction for use given with the package of the product.



### Safety regulations.

Review the Material Safety Data Sheet (MSDS) before use for proper and safe handling! Wear well-fitting protective goggles and protective gloves when working with Hilti HIT-ICE.

## Drilling

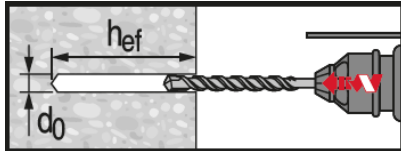

**Hammer drilled hole (HD)**

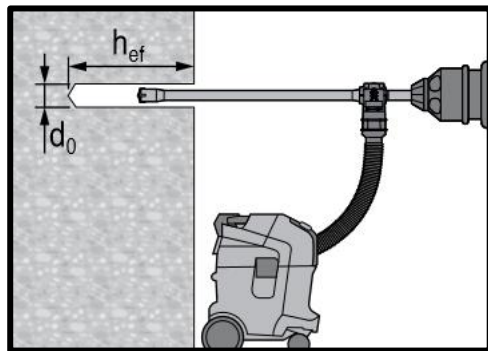

**Hammer drilled hole with Hollow Drilled Bit (HDB)**

No cleaning required.  
For dry and wet concrete, only.

## Cleaning

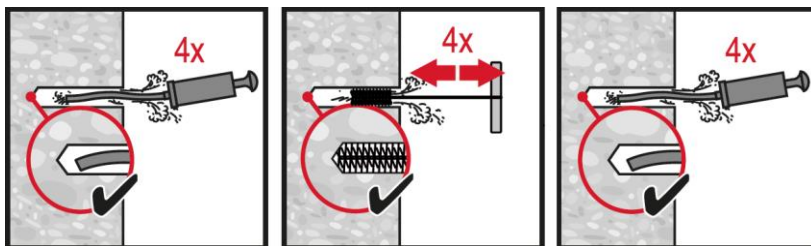

**Hammer Drilling:**

**Manual cleaning (MC)**

for drill diameters  $d_0 \leq 16$  mm and drill hole depth  $h_0 \leq 10 \cdot d$ .

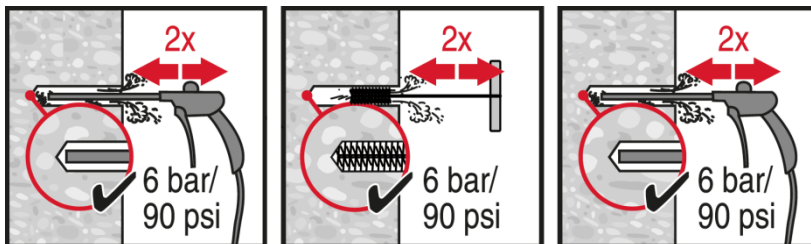

**Hammer Drilling:**

**Compressed air cleaning (CAC)**

For all drill hole diameters  $d_0$  and all drill hole depths  $h_0$ .

## Injection system

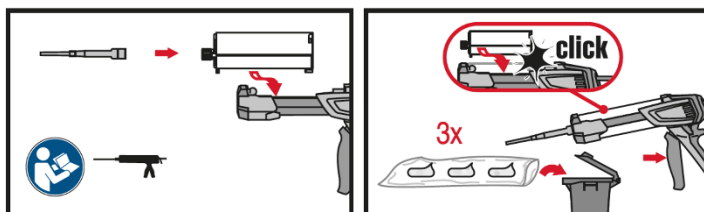

**Injection system preparation.**

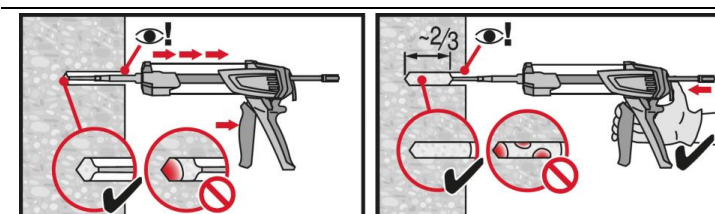

**Injection method for drill hole depth**

$h_{ef} \leq 250$  mm.

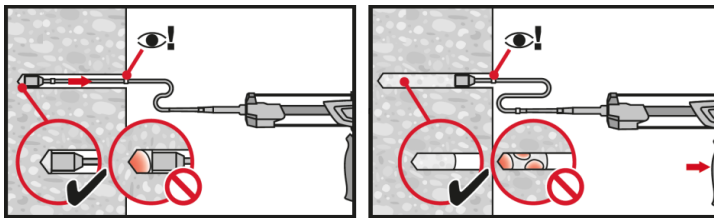

**Injection** method for drill hole depth  $h_{ef} > 250\text{mm}$ .

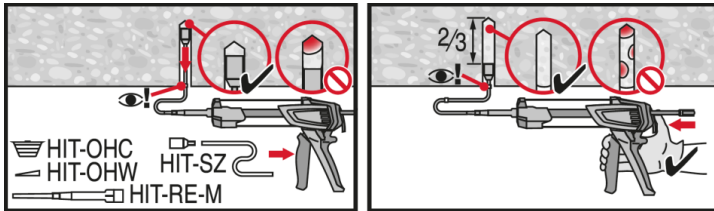

**Injection** method for overhead application.

**Setting the element**

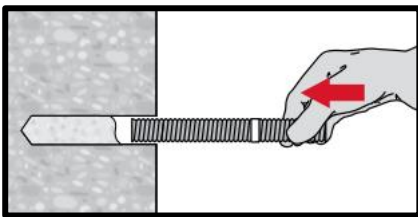

**Setting element**, observe working time " $t_{work}$ ".

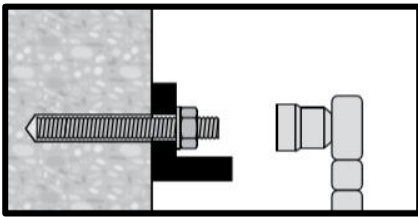

**Loading the anchor:** After required curing time  $t_{cure}$  the anchor can be loaded.

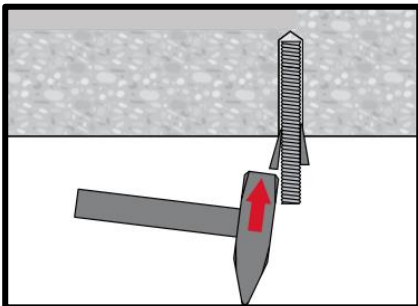

**Setting element** for overhead applications, observe working time " $t_{work}$ ".

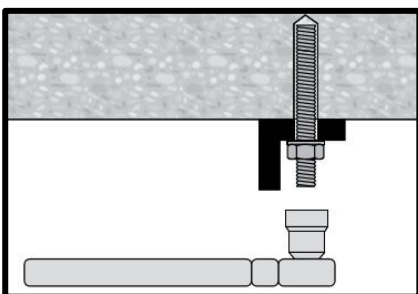

**Loading the anchor** after required curing time  $t_{cure}$  the anchor can be loaded.

# HIT-ICE injection mortar

## Anchor design (EN 1992-4) / Rebar elements / Concrete

### Injection mortar system



Hilti HIT-ICE  
296 ml cartridge



Rebar B500 B  
( $\phi 8 - \phi 25$ )

### Benefits

- Suitable for non-cracked concrete C20/25 to C50/60
- Suitable for dry and water saturated concrete
- High loading capacity
- High corrosion resistant
- Odourless resin
- Low installation temperature

### Base material



Concrete  
(non-cracked)

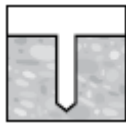

Dry concrete



Wet concrete

### Load condition

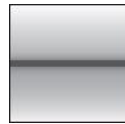

Static/  
quasi-static

### Installation conditions



Hammer  
drilling

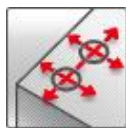

Small edge  
distance and  
spacing

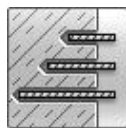

Variable  
embedment  
depth

### Other information



PROFIS  
Engineering  
design  
Software

### Approvals / certificates

Description	Authority / Laboratory	No. / date of issue
Hilti Technical Data <sup>a)</sup>	Hilti	2017-11-28

a) All data given in this section according to Hilti Technical Data.

## Static and quasi-static loading (for a single anchor)

### All data in this section applies to

- Correct setting
- No edge distance and spacing influence
- Steel failure
- Base material thickness, as specified in the table
- Embedment depth, as specified in the table
- Anchor material, as specified in the tables
- Concrete C20/25,  $f_{ck,cube} = 25 \text{ N/mm}^2$
- In-service temperature range I  
(min. base material temperature  $-40^\circ\text{C}$ , max. long/short term base material temperature:  $+24^\circ\text{C}/+40^\circ\text{C}$ )

### Embedment depth and base material thickness

Anchor- size			$\phi 8$	$\phi 10$	$\phi 12$	$\phi 14$	$\phi 16$	$\phi 20$	$\phi 25$
Embedment depth	$h_{ef}$	[mm]	80	90	110	125	125	170	210
Base material thickness	$h$	[mm]	110	120	145	165	165	220	275

### Characteristic resistance

Anchor size			$\phi 8$	$\phi 10$	$\phi 12$	$\phi 14$	$\phi 16$	$\phi 20$	$\phi 25$
Tensile	Rebar B500B	$N_{Rk}$	17,1	24,0	35,2	46,7	53,4	85,5	131,9
Shear	Rebar B500B	$V_{Rk}$	14,0	22,0	31,0	42,0	55,0	86,0	135,0

### Design resistance

Anchor size			$\phi 8$	$\phi 10$	$\phi 12$	$\phi 14$	$\phi 16$	$\phi 20$	$\phi 25$
Tensile	Rebar B500B	$N_{Rd}$	9,5	13,4	19,6	26,0	29,7	47,5	73,3
Shear	Rebar B500B	$V_{Rd}$	9,3	14,7	20,7	28,0	36,7	57,3	90,0

### Recommended loads <sup>a)</sup>

Anchor size			$\phi 8$	$\phi 10$	$\phi 12$	$\phi 14$	$\phi 16$	$\phi 20$	$\phi 25$
Tensile	Rebar B500B	$N_{Rec}$	6,8	9,5	14,0	18,5	21,2	33,9	52,4
Shear	Rebar B500B	$V_{Rec}$	6,7	10,5	14,8	20,0	26,2	41,0	64,3

a) With overall partial safety factor for action  $\gamma=1,4$ . The partial safety factors for action depend on the type of loading and shall be taken from national regulations.

## Materials

### Mechanical properties for rebar B500 B

Anchor size			φ8	φ10	φ12	φ14	φ16	φ20	φ25
Nominal tensile strength	$f_{uk}$	[N/mm <sup>2</sup> ]	550	550	550	550	550	550	550
Yield strength	$f_{yk}$	[N/mm <sup>2</sup> ]	500	500	500	500	500	500	500
Stressed cross-section	$A_s$	[mm <sup>2</sup> ]	50,3	78,5	113,1	153,9	201,1	314,2	490,9
Moment of resistance	$W$	[mm <sup>3</sup> ]	50,3	98,2	169,6	269,4	402,1	785,4	1534

### Material quality

Part	Material
Rebar B500 B	Geometry and mechanical properties according to DIN 488-2:1986 or DIN 488-2

## Setting information

### Installation temperature range:

-23°C to +32°C

### Service temperature range

Hilti HIT-ICE injection mortar may be applied in the temperature ranges given below. An elevated base material temperature may lead to a reduction of the design bond resistance.

Temperature range	Base material temperature	Maximum long term base material temperature	Maximum short term base material temperature
Temperature range I	-40 °C to + 40 °C	+ 24 °C	+ 40 °C
Temperature range II	-40 °C to + 40 °C	+ 43 °C	+ 54 °C

### Maximum short term base material temperature

Short term elevated base material temperatures are those that occur over brief intervals, e.g. as a result of diurnal cycling.

### Maximum long term base material temperature

Long term elevated base material temperatures are roughly constant over significant periods of time.

### Working time and curing time <sup>a)</sup>

Temperature of the base material	Maximum working time	Minimum curing time
$T_{BM}$	$t_{work}$	$t_{cure}^{a)}$
-23 °C	1,5 h	36 h
-18 °C	1,5 h	24 h
-7 °C	1 h	6 h
4 °C	15 min	1,5 h
16 °C	5 min	1 h
21 °C	2,5 min	45 min
32 °C	1 min	35 min

a) The curing time data are valid for dry base material only. In wet base material the curing times must be doubled

**Setting details**

Anchor size		Ø8	Ø10	Ø12	Ø14	Ø16	Ø20	Ø25
Nominal diameter of element	d [mm]	8	10	12	14	16	20	25
Nominal diameter of drill bit	d <sub>0</sub> [mm]	12	14	16	18	20	25	32
Effective anchorage depth (= drill hole depth)	h <sub>ef,min</sub> = h <sub>0</sub> [mm]	60	60	70	75	80	90	100
	h <sub>ef,max</sub> = h <sub>0</sub> [mm]	160	200	240	280	320	400	500
Minimum base material thickness <sup>a)</sup>	h <sub>min</sub> [mm]	h <sub>ef</sub> + 30 mm ≥ 100 mm		h <sub>ef</sub> + 2 d <sub>0</sub>				
Minimum spacing	s <sub>min</sub> [mm]	40	50	60	70	80	100	125
Minimum edge distance	c <sub>min</sub> [mm]	40	50	60	70	80	100	125
Critical spacing for splitting failure	s <sub>cr,sp</sub> [mm]	2 C <sub>cr,sp</sub>						
Critical edge distance for splitting failure <sup>b)</sup>	C <sub>cr,sp</sub> [mm]	1,0 · h <sub>ef</sub> for h / h <sub>ef</sub> ≥ 2,0						
		4,6 h <sub>ef</sub> - 1,8 h for 2,0 > h / h <sub>ef</sub> > 1,3						
		2,26 h <sub>ef</sub> for h / h <sub>ef</sub> ≤ 1,3						
Critical spacing for concrete cone failure	s <sub>cr,N</sub> [mm]	2 C <sub>cr,N</sub>						
Critical edge distance for concrete cone failure	C <sub>cr,N</sub> [mm]	1,5 h <sub>ef</sub>						

For spacing (edge distance) smaller than critical spacing (critical edge distance) the design loads have to be reduced.

a) h: base material thickness (h ≥ h<sub>min</sub>)

b) The critical edge distance for concrete cone failure depends on the embedment depth h<sub>ef</sub> and the design bond resistance. The simplified formula given in this table is on the safe side.

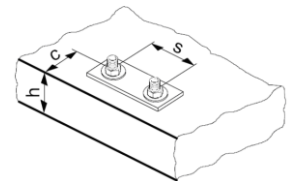
**Installation equipment**

Anchor size	Ø8	Ø10	Ø12	Ø14	Ø16	Ø20	Ø25
Rotary hammer	TE 2 – TE 16					TE 40 – TE 80	
Other tools	Blow out pump (h <sub>ef</sub> ≤ 10 · d), Compressed air gun, Set of cleaning brushes, dispenser, piston plug						

**Parameters of cleaning and setting tools**

Rebar size	Drilling and cleaning		Installation
	Hammer drilling	Brush HIT-RB	Piston plug HIT-SZ
	d <sub>0</sub> [mm]	size [mm]	size [mm]
Ø8	12	12	12
Ø10	14	14	14
Ø12	16	16	16
Ø14	18	18	18
Ø16	20	20	20
Ø20	25	25	25
Ø25	32	32	32



## Setting instructions

\*For detailed information on installation see instruction for use given with the package of the product.



### Safety regulations.

Review the Material Safety Data Sheet (MSDS) before use for proper and safe handling! Wear well-fitting protective goggles and protective gloves when working with Hilti HIT-ICE

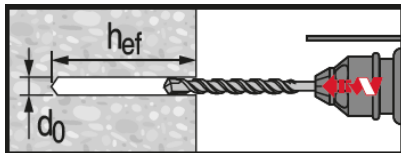

### Hammer drilled hole (HD)

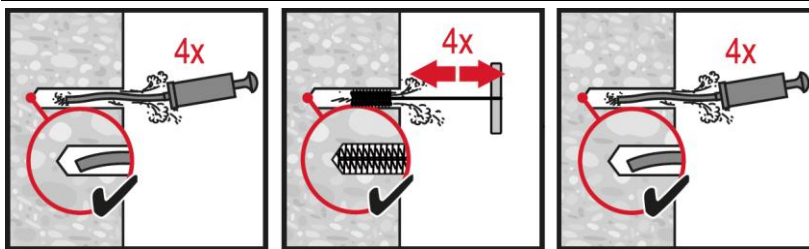

### Manual cleaning (MC)

For element sizes  $d \leq 16\text{mm}$  and embedment depth  $h_{ef} \leq 10d$  only.

Brush bore hole with required steel brush HIT-RB.

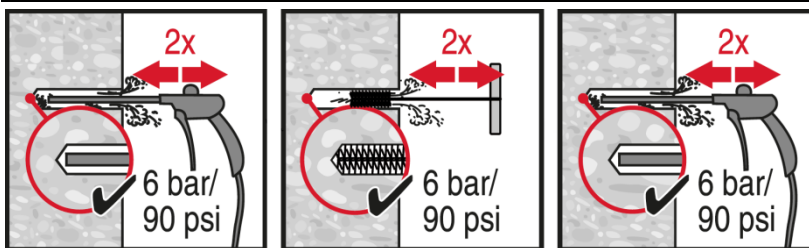

### Compressed air cleaning (CAC)

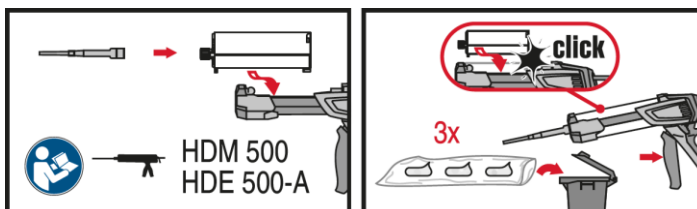

### Injection system preparation.

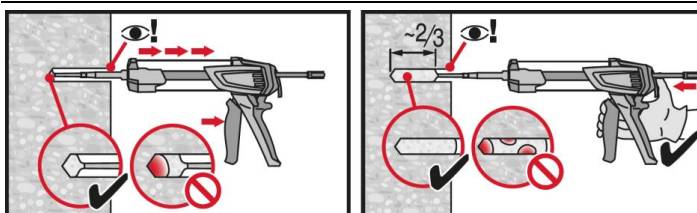

### Injection method for drill hole depth $h_{ef} \leq 250\text{mm}$

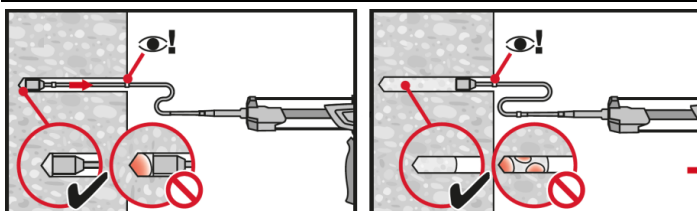

### Injection method for drill hole depth $h_{ef} > 250\text{mm}$ .

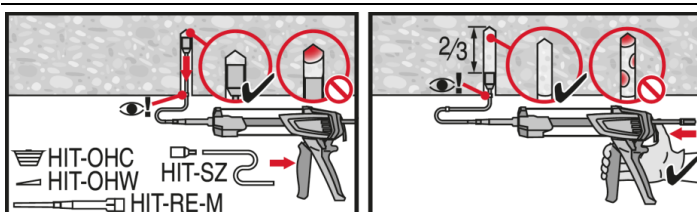

### Injection method for overhead application.

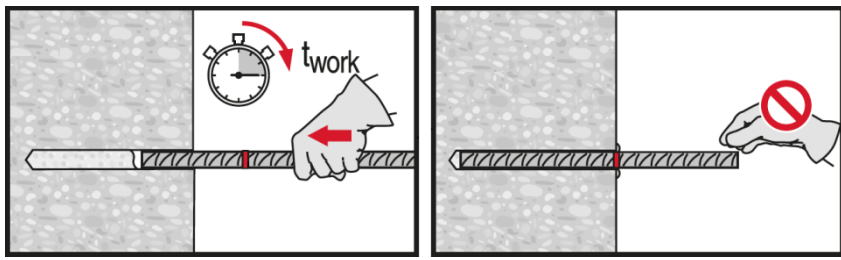

**Setting element**, observe working time " $t_{work}$ ".

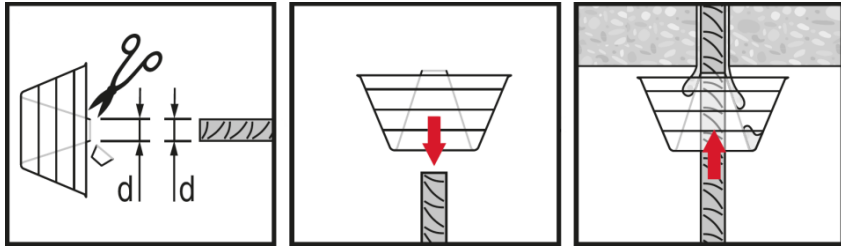

**Setting element** for overhead applications, observe working time " $t_{work}$ ".

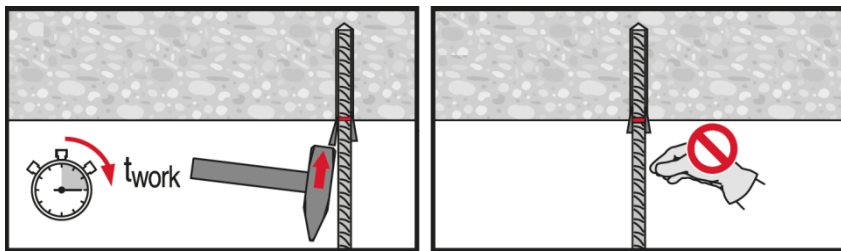

### 2.1.11 HVU-TZ

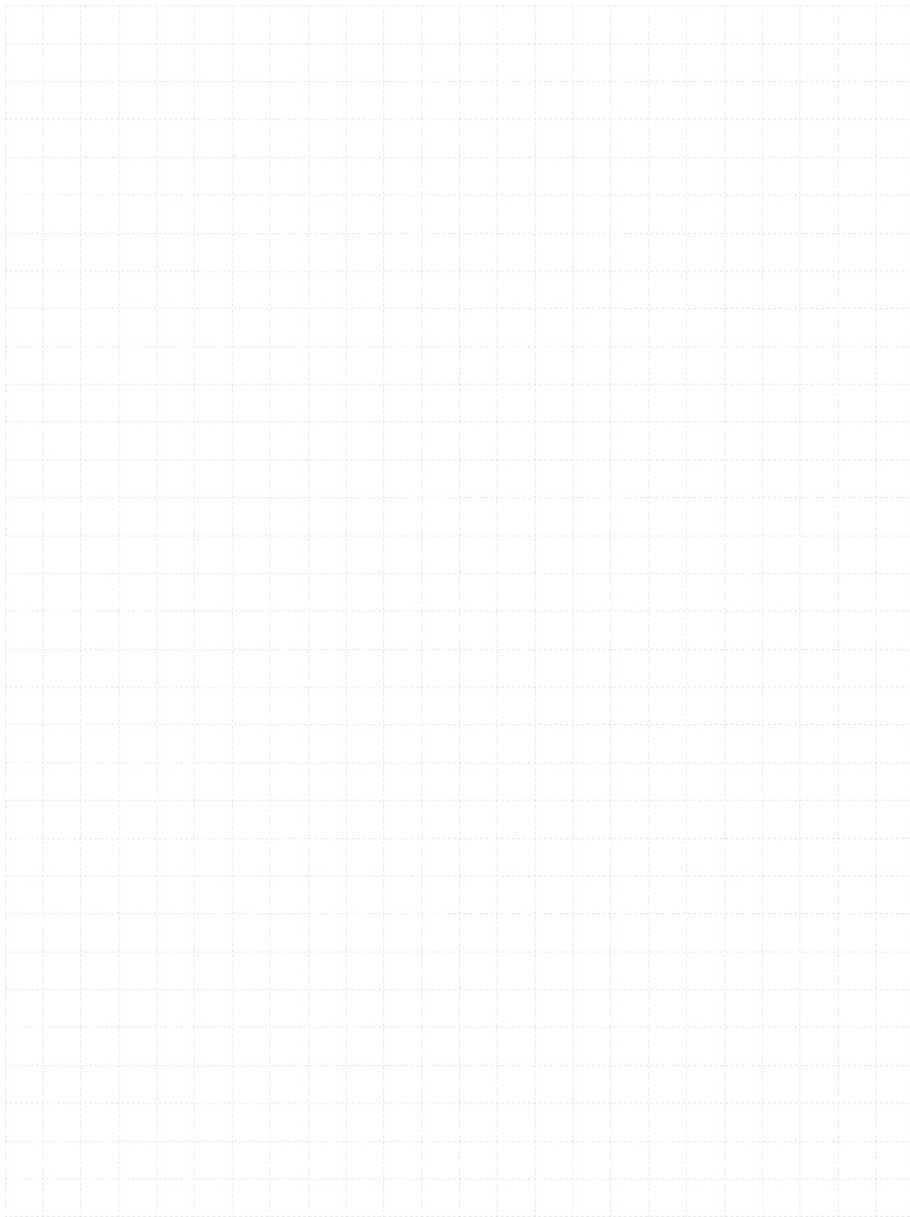

# HVZ (HVU-TZ+HAS-TZ) adhesive anchor system

## Anchor design / Rods / Concrete

### Anchor version



HVZ  
Mortar capsule



Anchor rod:  
HAS-TZ  
HAS-R-TZ  
HAS-HCR-TZ  
(M10-M20)

### Benefits

- Suitable for cracked and non-cracked concrete C20/25 to C50/60
- High loading capacity
- Suitable for dry and water saturated concrete

### Base material



Concrete  
(non-cracked)

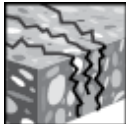

Concrete  
(cracked)



Dry  
concrete

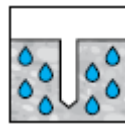

Wet  
concrete

### Load conditions

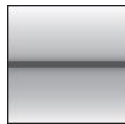

Static/  
quasi-static



Fire  
resistance



Shock

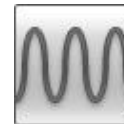

Fatigue

### Installation conditions

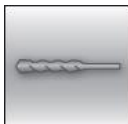

Hammer  
drilled  
holes

**SAFE-ET**

Hilti  
SafeSet  
technology

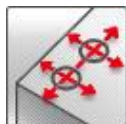

Small edge  
distance  
and  
spacing



European  
Technical  
Assessment



CE  
conformity

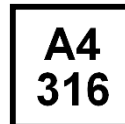

Corrosion  
resistance



High  
corrosion  
resistance



PROFIS  
Engineerin  
g design  
Software

### Other information

### Approvals / certificates

Description	Authority / Laboratory	No. / date of issue
European Technical Assessment <sup>a)</sup>	DIBt, Berlin	ETA-03/0032 / 2015-08-27
European Technical Assessment <sup>b)</sup>	DIBt, Berlin	ETA-17/0200 / 2020-10-05
Approval for shockproof fastenings in civil defense installations	Federal Office for Civil Protection, Bern	BZS D 09-602 / 2020-10-31
Fire test report ZTV – Tunnel	IBMB, Braunschweig	UB 3357/0550-2 / 2018-06-27
Fire test report	IBMB, Braunschweig	UB 3357/0550-1 / 2018-06-27
Assessment report (fire)	Warringtonfire	WF 327804/B / 2013-07-10

a) All data given in this section according ETA-03/0032, issue 2015-08-27.

b) All data given in this section according ETA-17/0200, issue 2020-10-05.

## Static and quasi-static resistance (for a single anchor)

### All data in this section applies to:

- Correct setting (See setting instruction)
- No edge distance and spacing influence
- Steel failure
- Base material thickness, as specified in the table
- Embedment depth, as specified in the table
- Anchor material, as specified in the tables
- Concrete C20/25
- Temperature range I  
(min. Base material temperature  $-40^{\circ}\text{C}$ , max. Long term/short term base material temperature:  $+50^{\circ}\text{C}/80^{\circ}\text{C}$ )

### Effective anchorage depth

Anchor size		M10	M12	M16		M20
Effective anchorage depth	$h_{\text{ef}}$ [mm]	75	95	105	125	170
Base material thickness	$h_{\text{min}}$ [mm]	150	190	210	250	340

### Characteristic resistance

Anchor size		M10x75	M12x95	M16x105	M16x125	M20x170	
<b>Non-cracked concrete</b>							
Tension	HAS-TZ	$N_{\text{Rk}}$ [kN]	32,0	40,0	52,9	68,8	109,0
	HAS-RTZ, HAS-HCR-TZ		32,0	40,0	52,9	68,8	109,0
Shear	HAS-TZ	$V_{\text{Rk}}$ [kN]	18,0	27,0	51,0	51,0	88,0
	HAS-RTZ, HAS-HCR-TZ		20,0	30,0	56,0	56,0	98,0
<b>Cracked concrete</b>							
Tension	HAS-TZ	$N_{\text{Rk}}$ [kN]	22,4	31,9	37,1	48,1	76,3
	HAS-RTZ, HAS-HCR-TZ		22,4	31,9	37,1	48,1	76,3
Shear	HAS-TZ	$V_{\text{Rk}}$ [kN]	18,0	27,0	51,0	51,0	88,0
	HAS-RTZ, HAS-HCR-TZ		20,0	30,0	56,0	56,0	98,0

### Design resistance

Anchor size		M10x75	M12x95	M16x105	M16x125	M20x170	
<b>Non-cracked concrete</b>							
Tension	HAS-TZ	$N_{\text{Rd}}$ [kN]	21,3	26,7	35,3	45,8	72,7
	HAS-RTZ, HAS-HCR-TZ		21,3	26,7	35,3	45,8	72,7
Shear	HAS-TZ	$V_{\text{Rd}}$ [kN]	14,4	21,6	40,8	40,8	70,4
	HAS-RTZ, HAS-HCR-TZ		16,0	24,0	44,8	44,8	78,4
<b>Cracked concrete</b>							
Tension	HAS-TZ	$N_{\text{Rd}}$ [kN]	14,9	21,3	24,7	32,1	50,9
	HAS-RTZ, HAS-HCR-TZ		14,9	21,3	24,7	32,1	50,9
Shear	HAS-TZ	$V_{\text{Rd}}$ [kN]	14,4	21,6	40,8	40,8	70,4
	HAS-RTZ, HAS-HCR-TZ		16,0	24,0	44,8	44,8	78,4

**Recommended loads <sup>a)</sup>**

Anchor size				M10x75	M12x95	M16x105	M16x125	M20x170
<b>Non-cracked concrete</b>								
Tension	HAS-TZ	N <sub>Rec</sub>	[kN]	15,2	19,0	25,2	32,7	51,9
	HAS-RTZ, HAS-HCR-TZ			15,2	19,0	25,2	32,7	51,9
Shear	HAS-TZ	V <sub>Rec</sub>	[kN]	10,3	15,4	29,1	29,1	50,3
	HAS-RTZ, HAS-HCR-TZ			11,4	17,1	32,0	32,0	56,0
<b>Cracked concrete</b>								
Tension	HAS-TZ	N <sub>Rec</sub>	[kN]	10,7	15,2	17,6	22,9	36,3
	HAS-RTZ, HAS-HCR-TZ			10,7	15,2	17,6	22,9	36,3
Shear	HAS-TZ	V <sub>Rec</sub>	[kN]	10,3	15,4	29,1	29,1	50,3
	HAS-RTZ, HAS-HCR-TZ			11,4	17,1	32,0	32,0	56,0

a) With overall partial safety factor for action  $\gamma = 1,4$ . The partial safety factors for action depend on the type of loading and shall be taken from national regulations.

## Fatigue resistance

### All data in this section applies to:

- Correct setting (see setting instruction)
- No edge distance and spacing influence
- Steel failure
- Base material thickness, as specified in the table
- Embedment depth, as specified in the table
- One anchor material, as specified in the tables
- Concrete C20/25
- Temperature range I  
(min. Base material temperature -40°C, max. Long term/short term base material temperature: +50°C/80°C)
- Anchor is issued with Hilti filling set (see setting instruction)

### Effective anchorage depth

Anchor size			M10	M12	M16	
Effective anchorage depth	$h_{ef}$	[mm]	75	95	105	125
Base material thickness	$h_{min}$	[mm]	150	190	210	250

### Characteristic resistance

Anchor size				M10x75	M12x95	M16x105	M16x125
<b>Non-cracked concrete</b>							
Tension	HAS-TZ	$\Delta N_{Rk,0,\infty}$	[kN]	10,0	16,0	20,0	26,0
	HAS-HCR-TZ			-	15,0	-	20,8
Shear	HAS-TZ	$\Delta V_{Rk,0,\infty}$	[kN]	4,5	8,5	15,0	15,0
	HAS-HCR-TZ			-	8,5	-	7,6
<b>Cracked concrete</b>							
Tension	HAS-TZ	$\Delta N_{Rk,0,\infty}$	[kN]	10,0	15,9	20,0	24,1
	HAS-HCR-TZ			-	15,0	-	20,8
Shear	HAS-TZ	$\Delta V_{Rk,0,\infty}$	[kN]	4,5	8,5	15,0	15,0
	HAS-HCR-TZ			-	8,5	-	7,6

### Design resistance

Anchor size				M10x75	M12x95	M16x105	M16x125
<b>Non-cracked concrete</b>							
Tension	HAS-TZ	$\Delta N_{Rd,0,\infty}$	[kN]	7,4	10,7	14,8	19,3
	HAS-HCR-TZ			-	10,7	-	15,4
Shear	HAS-TZ	$\Delta V_{Rd,0,\infty}$	[kN]	3,3	6,3	11,1	11,1
	HAS-HCR-TZ			-	6,3	-	5,6
<b>Cracked concrete</b>							
Tension	HAS-TZ	$\Delta N_{Rd,0,\infty}$	[kN]	7,4	10,6	12,4	16,0
	HAS-HCR-TZ			-	10,6	-	15,4
Shear	HAS-TZ	$\Delta V_{Rd,0,\infty}$	[kN]	3,3	6,3	11,1	11,1
	HAS-HCR-TZ			-	6,3	-	5,6

For more information about different failure modes under fatigue load please see the full ETA-17/0200 report.

## Materials

### Mechanical properties

Anchor size			M10x75	M12x95	M16x105	M16x125	M20x170	
Nominal tensile strength	$f_{uk}$	[N/mm <sup>2</sup> ]	800	800	800	800	800	
Yield strength	$f_{yk}$	[N/mm <sup>2</sup> ]	640	640	640	640	640	
Stressed cross-section	tension	$A_s$	[mm <sup>2</sup> ]	44,2	63,6	113	113	227
	shear			50,3	73,9	141	141	245
Moment of resistance	$W$	[mm <sup>3</sup> ]	50,3	89,6	236	236	541	

### Material quality

Part	Material
<b>Zinc coated steel</b>	
Anchor rod HAS-TZ	Coated, elongation at fracture ( $l_0=5d$ ) > 8% ductile
Filling washer <sup>a)</sup>	Electroplated zinc coated $\geq 5 \mu\text{m}$
Spherical washer <sup>a)</sup>	Electroplated zinc coated $\geq 5 \mu\text{m}$
Nut	Electroplated zinc coated $\geq 5 \mu\text{m}$
Lock Nut <sup>a)</sup>	Electroplated zinc coated $\geq 5 \mu\text{m}$
<b>Stainless steel</b>	
Anchor rod HAS-RTZ	Stainless steel 1.4401, 1.4404, elongation at fracture
Filling washer <sup>a)</sup>	Stainless steel
Spherical washer <sup>a)</sup>	Stainless steel
Nut	Stainless steel
Lock Nut <sup>a)</sup>	Stainless steel
<b>Stainless steel and high corrosion resistant steel <sup>b)</sup></b>	
Anchor rod HAS-HCR-TZ	Stainless steel 1.4529, elongation at fracture ( $l_0=5d$ ) > 8%
Filling washer <sup>a)</sup>	Stainless steel
Spherical washer <sup>a)</sup>	Stainless steel
Nut	Stainless steel 1.4529
Lock Nut <sup>a)</sup>	Stainless steel

a) Filling set (contains filling washer, spherical washer and lock nut) needs to be purchased as separate item;

b) Corrosion resistance class III acc. to EN 1993-1-4: 2006+A1:2015



## Setting information

### Installation temperature range:

Static and quasi-static loading:  $-5^{\circ}\text{C}$  to  $+40^{\circ}\text{C}$

Fatigue cycling loading:  $0^{\circ}\text{C}$  to  $+40^{\circ}\text{C}$

### In service temperature range:

Hilti HVZ adhesive anchor with anchor rod HAS-TZ may be applied in the temperature ranges given below. An elevated base material temperature may lead to a reduction of the design bond resistance.

Temperature range	Base material temperature	Maximum long term base material temperature	Maximum short term base material temperature
Temperature range I	$-40^{\circ}\text{C}$ to $+80^{\circ}\text{C}$	$+50^{\circ}\text{C}$	$+80^{\circ}\text{C}$

### Max short term base material temperature

Short-term elevated base material temperatures are those that occur over brief intervals, e.g. as a result of diurnal cycling.

### Max long term base material temperature

Long-term elevated base material temperatures are roughly constant over significant periods of time.

### Curing time for mortar capsule HVU-TZ<sup>a)</sup>

Temperature of the base material	Release screwed on setting tool curing time	Full load curing time
$T_{\text{BM}}$	$t_{\text{rel}}$	$t_{\text{cure}}$
$-5^{\circ}\text{C} \leq T_{\text{BM}} < 0^{\circ}\text{C}$	60 min	5 hour
$0^{\circ}\text{C} \leq T_{\text{BM}} < 10^{\circ}\text{C}$	30 min	1 hour
$10^{\circ}\text{C} \leq T_{\text{BM}} < 20^{\circ}\text{C}$	20 min	30 min
$20^{\circ}\text{C} \leq T_{\text{BM}} < 40^{\circ}\text{C}$	8 min	20 min

a) The curing time data are valid for dry base material only. In wet base material, the curing times must be doubled.

**Setting details**

Anchor size		M10x75	M12x95	M16x105	M16x125	M20x170
Diameter of element	d [mm]	10	12	16	16	20
Nominal diameter of drill bit	d <sub>0</sub> [mm]	12	14	18	18	25
Effective anchorage depth	h <sub>ef</sub> [mm]	75	95	105	125	170
Drill hole depth	h <sub>1</sub> [mm]	90	110	125	145	195
Min. thickness of concrete member	h <sub>min</sub> <sup>a)</sup> [mm]	150	190	160	190	340
Standard fixture thickness (without Filling Set)	t <sub>fix</sub> <sup>d)</sup> [mm]	15 / 30 / 50	25 / 40 / 50 / 100	30 / 60 / 100	30 / 60 / 100	40
Standard fixture thickness (with Filling Set)	t <sub>fix</sub> <sup>d)</sup> [mm]	10 / 21 / 41	10 / 30 40 / 90	16 / 19 / 49 / 89	16 / 19 / 49 / 89	-
Maximum diameter of clearance hole in the fixture (without Filling Set)	d <sub>f1</sub> [mm]	12	14	18	18	22
Maximum diameter of clearance hole in the fixture (with Filling Set)	d <sub>f2</sub> [mm]	14	16	20	20	-
<b>Cracked concrete</b>						
Minimum spacing	s <sub>min</sub> [mm]	50	60	70	70	80
Minimum edge distance	c <sub>min</sub> [mm]	50	60	70	70	80
<b>Non-cracked concrete</b>						
Minimum spacing	s <sub>min</sub> [mm]	50	60	70	70	80
Minimum edge distance	c <sub>min</sub> [mm]	50	70	85	85	80
Critical spacing for splitting failure	s <sub>cr,sp</sub> [mm]	2 c <sub>cr,sp</sub>				
Critical edge distance for splitting failure <sup>b)</sup>	c <sub>cr,sp</sub> [mm]	1,5·h <sub>ef</sub>				
Critical spacing for concrete cone failure	s <sub>cr,N</sub> [mm]	2 c <sub>cr,N</sub>				
Critical edge distance for concrete cone failure <sup>b)</sup>	c <sub>cr,N</sub> [mm]	1,5 h <sub>ef</sub>				
Installation torque <sup>c)</sup>	HAS-TZ	40	50	90	90	150
	HAS-RTZ	T <sub>inst</sub> [Nm]	50	70	100	100
	HAS-HCR-TZ		50	70	100	100

For spacing (edge distance) smaller than critical spacing (critical edge distance) the design loads have to be reduced.

a) h: base material thickness (h ≥ h<sub>min</sub>)

b) The critical edge distance for concrete cone failure depends on the embedment depth h<sub>ef</sub> and the design bond resistance. The simplified formula given in this table is on the safe side.

c) Max. recommended torque moment to avoid splitting failure during installation with min. spacing and/or edge distance

d) Other fixture thickness' are possible

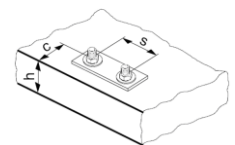



**Installation equipment**

Anchor size	M10x75	M12x95	M16x105	M16x125	M20x170
Rotary hammer	TE 1 -TE 30		TE 1 – TE 60		TE 30 – TE 80
Tools	compressed air gun and blow out pump, setting tool				

**Setting tool**

HAS-(E-)TZ-...	M10	M12	M16	M20
HAS-TZ	TE-C HEX M10	TE-C HEX M12	TE-C HEX M16	TE-C HEX M120
HAS-E-TZ	TE-C E M10	TE-C E M12	TE-C (Y) M16	TE-C E M20

**Drilling and cleaning parameters**

HAS-TZ	Hammer drill	Hollow Drill Bit
	d <sub>0</sub> [mm]	
		
<b>M10</b>	12	-
<b>M12</b>	14	14
<b>M16</b>	18	18
<b>M20</b>	25	25

## Setting instructions

\*For detailed information on installation see instruction for use given with the package of the product.



### Safety regulations.

Review the Material Safety Data Sheet (MSDS) before use for proper and safe handling! Wear well-fitting protective goggles and protective gloves when working with Hilti HVZ.

### Hole drilling

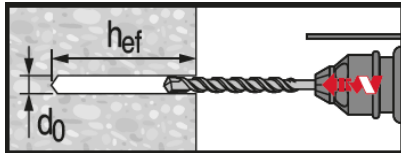

#### Hammer drilled hole

For dry or wet concrete, only.

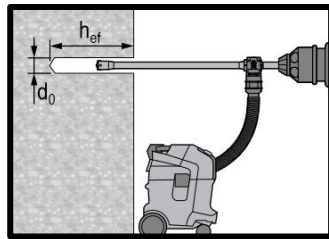

#### Hammer drilled hole with Hollow drill bit

For dry and wet concrete, only.  
No cleaning required.

### Hole cleaning

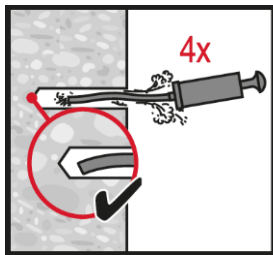

#### Manual cleaning for hammer drilled hole

### Setting the element

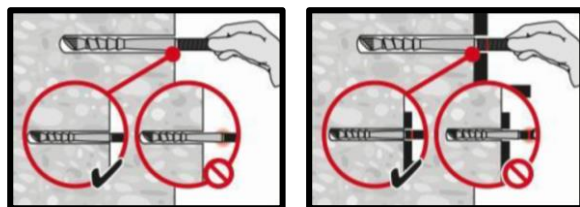

**Check** the setting depth.

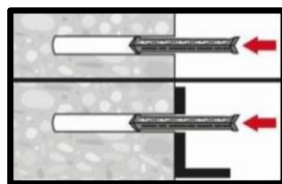

**Insert the foil capsule** with the peak ahead to the back of the hole.

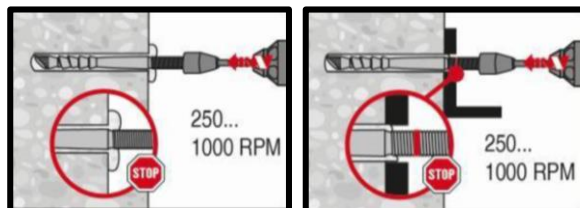

**Drive the anchor rod** with the plugged tool into the hole.

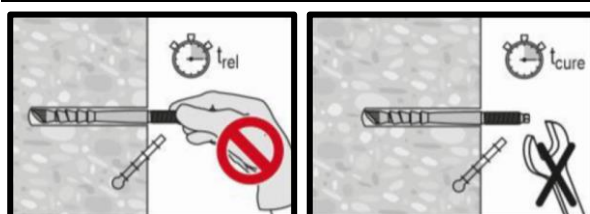

After **required time** remove the screwed on setting tool and excess mortar

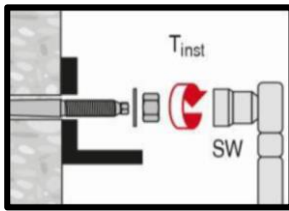

**Loading the anchor** after required curing time  $t_{cure}$  and apply installation torque

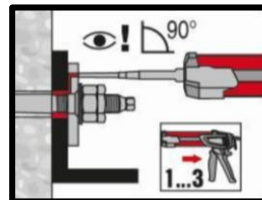
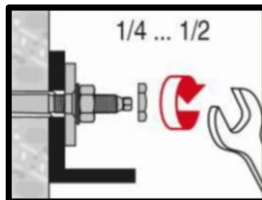
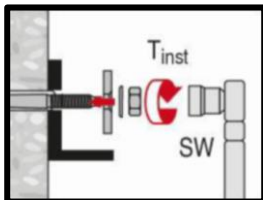





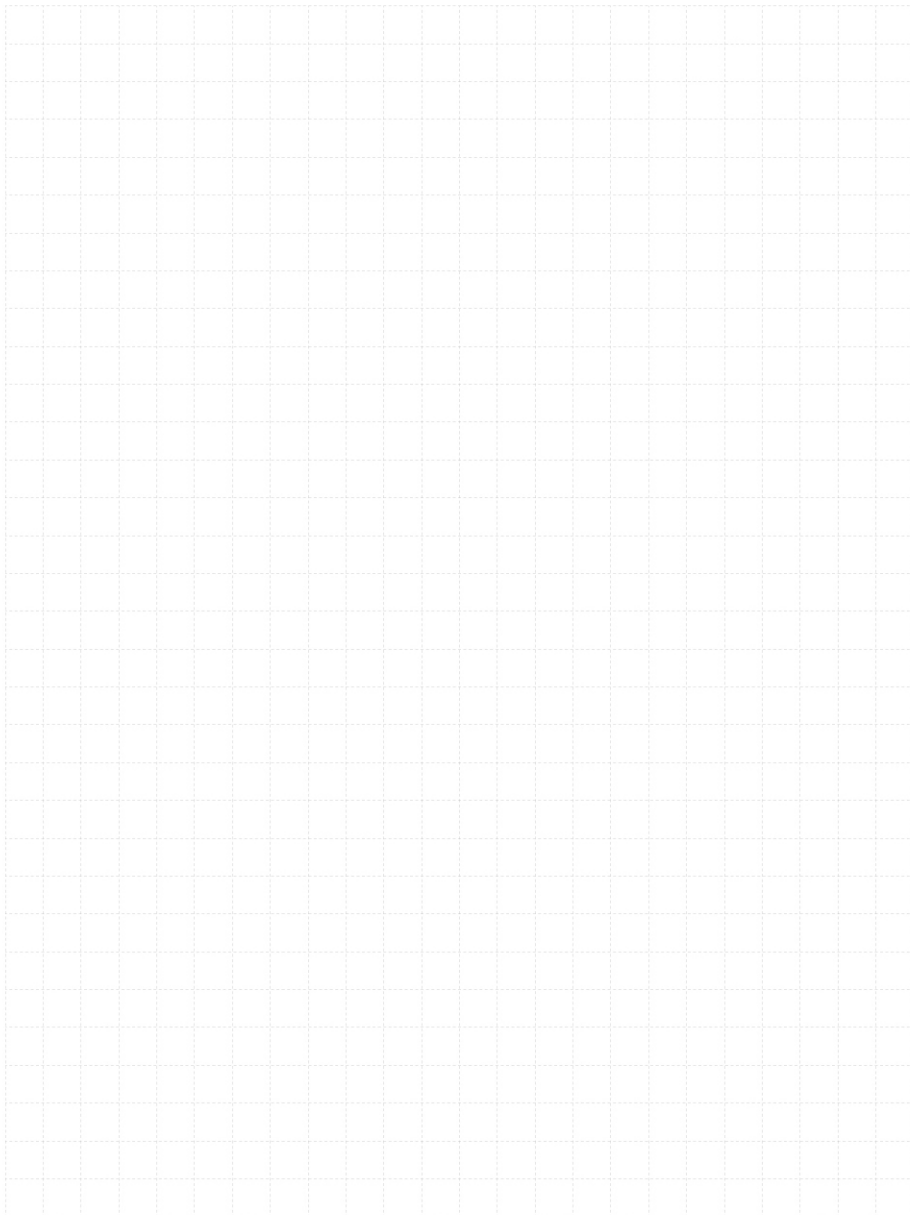
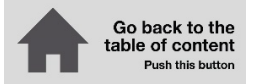

**Use of filling set.** Apply installation torque after required curing time, apply the lock nut and fill annular gap between anchor rod and fixture using Hilti injection mortar HY 200-A/R or HY 200-R V3.









## 2.1.12 HUS4 MAX

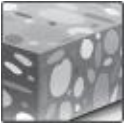

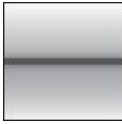
# HUS4 Bonded screw anchor

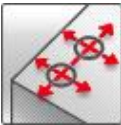
## Ultimate performance screw anchor for single point fastening

Anchor version		Benefits
	HUS4-H(F) (10-16)*	- High productivity - less drilling and fewer operations than with conventional anchors
	HUS4-C (10)	- ETA approval for cracked and non-cracked concrete - ETA approval for Seismic C1 and C2**
	HUS4-A(F) (10 and 14)	- ETA approval for adjustability (unscrew-rescrew)** - Smaller edge and spacing distance
	HUS4-HR (10 and 14)	- One embedment at the level of h.nom3 of HUS4 for maximum performance - No cleaning allowed size 10 to 16
	HUS4-CR (10)	- HUS4-HF and HUS4-AF with multilayer coatings for additional corrosion protection - Through fastening with H, A and C head
	HUS4-MAX capsule	- Pre-fastening with A head

Base material	Load conditions
 <p>Concrete (non-cracked)</p>  <p>Concrete (cracked)</p>	 <p>Static / quasi-static</p>  <p>Seismic ETA-C1/C2</p>  <p>Fire resistance</p>
Installation conditions	Other information
 <p>Small edge distance and spacing</p>	 <p>European Technical Assessment</p>  <p>CE conformity</p>  <p>PROFIS Engineering design software</p>

### Approvals / certificates

Description	Authority	No. / date of issue
European Technical Assessment	DIBt	ETA-18/1160 / 27-07-2022
Fire test report	DIBt	ETA-18/1160 / 27-07-2022

\*HUS4-HF not available in size 12

\*\*Not available for HUS4-HR and HUS4-CR

**Static and quasi-static loading data (for a single anchor)**
**All data in this section applies to:**

- Correct setting (See setting instruction)
- No edge distance and spacing influence
- Steel failure
- Minimum base material thickness
- Concrete C 20/25,  $f_{ck,cube} = 25 \text{ N/mm}^2$

**Anchorage depth**

Anchor size		10		12	14		16
Type	HUS4-	H(F), C, A(F)	HR, CR	H	H(F), A(F)	HR	H
Nominal embedment depth	$h_{nom}$ [mm]	$h_{nom3}$		$h_{nom3}$	$h_{nom3}$		$h_{nom3}$
		85	90	100	115	110	130

**Characteristic resistance**

Anchor size		10		12	14		16
Type	HUS4	H(F), C, A(F)	HR, CR	H	H(F), A(F)	HR	H
		$h_{nom3}$		$h_{nom3}$	$h_{nom3}$		$h_{nom3}$
<b>Non-cracked concrete</b>							
Tension	$N_{Rk}$ [kN]	38,0	40,0	49,2	60,7	56,8	72,9
Shear	$V_{Rk}$ [kN]	32,0	33,0	44,9	62,0	77,0	73,1
<b>Cracked concrete</b>							
Tension	$N_{Rk}$ [kN]	24,0	24,0	34,4	42,0	39,7	51,0
Shear	$V_{Rk}$ [kN]	32,0	33,0	44,9	62,0	77,0	73,1

**Design resistance**

Anchor size		10		12	14		16
Type	HUS4	H(F), C, A(F)	HR, CR	H	H(F), A(F)	HR	H
		$h_{nom3}$		$h_{nom3}$	$h_{nom3}$		$h_{nom3}$
<b>Non-cracked concrete</b>							
Tension	$N_{Rd}$ [kN]	25,3	26,7	32,8	40,4	37,8	48,6
Shear	$V_{Rd}$ [kN]	25,6	22,0	35,9	49,6	51,3	58,5
<b>Cracked concrete</b>							
Tension	$N_{Rd}$ [kN]	16,0	16,0	23,0	28,0	26,5	34,0
Shear	$V_{Rd}$ [kN]	25,6	22,0	35,9	49,6	51,3	58,5

**Recommended loads**

Anchor size		10		12	14		16
Type	HUS4	H(F), C, A(F)	HR, CR	H	H(F), A(F)	HR	H
		$h_{nom3}$		$h_{nom3}$	$h_{nom3}$		$h_{nom3}$
<b>Non-cracked concrete</b>							
Tension	$N_{Rec}$ [kN]	18,1	19,0	23,4	28,9	27,0	34,7
Shear	$V_{Rec}$ [kN]	18,3	15,7	25,7	35,4	36,7	41,8
<b>Cracked concrete</b>							
Tension	$N_{Rec}$ [kN]	11,4	11,4	16,4	20,0	18,9	24,3
Shear	$V_{Rec}$ [kN]	18,3	15,7	25,7	35,4	36,7	41,8

a) With overall partial safety factor for action  $\gamma = 1,4$ . The partial safety factors for action depend on the type of loading and shall be taken from national regulations.



**Seismic loading data (for single anchor)**
**All data in this section applies to:**

- Correct setting (See setting instruction)
- No edge distance and spacing influence
- Steel failure
- Minimum base material thickness
- Concrete C 20/25,  $f_{ck,cube} = 25 \text{ N/mm}^2$
- $\alpha_{gap} = 1,0$  (using Hilti seismic filling set) or  $\alpha_{gap} = 0,5$  (without using Hilti seismic filling set) accordingly

**Anchorage depth**

Anchor size	10	12	14
Nominal embedment depth $h_{nom}$ [mm]	$h_{nom3}$	$h_{nom3}$	$h_{nom3}$
	85	100	115

**Characteristic resistance in case of seismic performance category C2**

Anchor size	10	12	14	
<b>with Hilti filling set</b>				
Type	HUS4 -	H(F), A(F)	H	H(F), A(F)
Tension	$N_{Rk,seis}$ [kN]	10,7	17,2	18,2
Shear	$V_{Rk,seis}$	21,5	27,2	46,5
<b>without Hilti filling set</b>				
Type	HUS4 -	H(F), C, A(F)	H	H(F), A(F)
Tension	$N_{Rk,seis}$ [kN]	10,7	17,2	18,2
Shear	$V_{Rk,seis}$	6,9	11,3	17,2

**Design resistance in case of seismic performance category C2**

Anchor size	10	12	14	
<b>with Hilti filling set</b>				
Type	HUS4 -	H(F), A(F)	H	H(F), A(F)
Tension	$N_{Rd,seis}$ [kN]	7,1	11,5	12,1
Shear	$V_{Rd,seis}$	17,2	21,8	37,2
<b>without Hilti filling set</b>				
Type	HUS4 -	H, HF, C, A, AF	H	H, HF, A, AF
Tension	$N_{Rd,seis}$ [kN]	7,1	11,5	12,1
Shear	$V_{Rd,seis}$	5,5	9,0	13,8

**Characteristic resistance in case of seismic performance category C1**

Anchor size		10	12	14
Type		H(F), C, A(F)	H	H(F), A(F)
<b>with Hilti filling set (HUS4-H and HUS4-A)</b>				
Tension	$N_{Rk,seis}$ [kN]	22,9	29,3	36,1
Shear	$V_{Rk,seis}$ [kN]	26,7	38,9	34,5
<b>without Hilti filling set</b>				
Tension	$N_{Rk,seis}$ [kN]	22,9	29,3	36,1
Shear	$V_{Rk,seis}$ [kN]	13,4	19,5	17,3

**Design resistance in case of seismic performance category C1**

Anchor size		10	12	14
Type		H(F), C, A(F)	H	H(F), A(F)
<b>with Hilti filling set (HUS4-H and HUS4-A)</b>				
Tension	$N_{Rd,seis}$ [kN]	15,3	19,5	24,1
Shear	$V_{Rd,seis}$ [kN]	21,4	31,1	27,6
<b>without Hilti filling set</b>				
Tension	$N_{Rd,seis}$ [kN]	15,3	19,5	24,1
Shear	$V_{Rd,seis}$ [kN]	10,7	15,6	13,8

## Fire resistance

### All data in this section applies to:

- Correct setting (See setting instruction)
- No edge distance and spacing influence
- Steel failure
- Minimum base material thickness
- Concrete C 20/25,  $f_{ck,cube} = 25 \text{ N/mm}^2$
- Partial safety factor for resistance under fire exposure  $\gamma_{M,fi}=1,0$  (in absence of other national regulations)

### Characteristic resistance

Anchor size		10				12	14			16
Type	HUS4	H(F)	C	A(F)	HR <sup>a)</sup>	H	H(F)	A(F)	HR <sup>a)</sup>	H(F)
		$h_{nom3}$				$h_{nom3}$	$h_{nom3}$			$h_{nom3}$
<b>Fire Exposure R30</b>										
Tension	$N_{Rk}$ [kN]	4,2	1,0	4,2	4,0	6,1	7,5	7,5	6,3	8,7
Shear	$V_{Rk}$ [kN]	4,2	1,0	4,2	18,5	7,7	10,5	8,4	41,7	10,7
<b>Fire Exposure R120</b>										
Tension	$N_{Rk}$ [kN]	1,7	0,6	2,1	2,4	3,1	4,4	4,3	5,0	4,5
Shear	$V_{Rk}$ [kN]	1,7	0,6	2,1	2,4	3,1	4,4	4,3	5,4	4,5

<sup>a)</sup> Values for this head configuration are based on Hilti technical data

### Design resistance

Anchor size		10				12	14			16
Type	HUS4	H(F)	C	A(F)	HR <sup>a)</sup>	H	H(F)	A(F)	HR <sup>a)</sup>	H(F)
		$h_{nom3}$				$h_{nom3}$	$h_{nom3}$			$h_{nom3}$
<b>Fire Exposure R30</b>										
Tension	$N_{Rd}$ [kN]	4,2	1,0	4,2	4,0	6,1	7,5	7,5	6,3	8,7
Shear	$V_{Rd}$ [kN]	4,2	1,0	4,2	18,5	7,7	10,5	8,4	41,7	10,7
<b>Fire Exposure R120</b>										
Tension	$N_{Rd}$ [kN]	1,7	0,6	2,1	2,4	3,1	4,4	4,3	5,0	4,5
Shear	$V_{Rd}$ [kN]	1,7	0,6	2,1	2,4	3,1	4,4	4,3	5,4	4,5

For more information about different failure modes and fire resistance times please see the full ETA-18/1160 report.

## Materials

**Foil capsule HUS4-MAX size 10 to 14:** resin and hardener

Marking:

HUS4-MAX size

Expiry date mm/yyyy



## Material quality

Type	Material
HUS4 – H, A, C	Carbon steel, galvanized
HUS4 – HF, AF	Carbon steel, multi-layer coating <sup>a)</sup>
HUS4 – HR, CR	Stainless steel

a) Multi-layer coating provides a higher corrosion resistance compared to regular hot dip galvanized (HDG) systems with a 40µm coating thickness.

## Head configuration

Type	Part	
HUS4-H HUS4-HF	Hexagonal head	
HUS4-C	Countersunk head	
HUS4-A	External thread	 Hilti HUS4-A, size 10 with external thread M12 and size 14 with external thread M16
HUS4-HR	Hexagonal head	
HUS4-CR	Countersunk head	

## Fastener dimensions and marking HUS4-H(F)

Anchor size		10			12	14		16
Type	HUS4	H(F)	HR	H	H(F)	HR	H	
Outer diameter of screw	$d_t$ [mm]	12,70	12,25	14,70	16,70	16,56	18,80	
Diameter of integrated	$d_i$ [mm]	20,50	20,50	23,60	29,00	30,00	32,60	
Length of the screw	L [mm]	90/305	95/130	130/150	130/150	120/135	100/205	

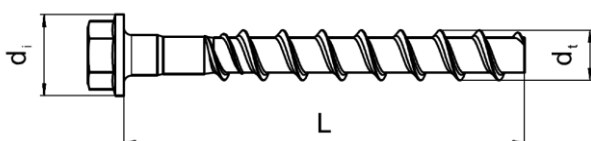

**HUS4:** Hilti Universal Screw 4<sup>th</sup> generation

**H:** Hexagonal head, galvanized

**HF:** Hexagonal head, multilayer coating

**HR:** Hexagonal head, stainless steel

**10:** Nominal screw diameter

**100:** total length of the screw

**Fastener dimensions and marking HUS4-C**

Anchor size		10	
Type	HUS4	C	CR
Outer diameter of the screw thread	$d_t$ [mm]	12,70	12,25
Countersunk head diameter	$d_h$ [mm]	21,00	21,00
Length of the screw (min/max)	L [mm]	100/120	105

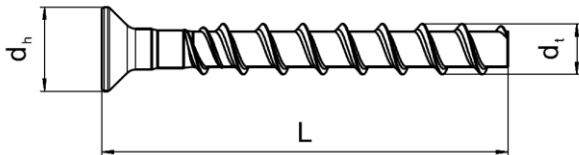

**HUS4:** Hilti Universal Screw 4<sup>th</sup> generation  
**C:** Countersunk head  
**CR:** Countersunk head, stainless steel  
**10:** Nominal screw diameter  
**100:** total length of the screw

**Fastener dimensions and marking HUS4-A(F)**

Anchor size		10	14
Type	HUS4	A(F)	A(F)
Outer diameter of the screw thread	$d_t$ [mm]	12,70	16,70
Diameter of the metric thread	$d_M$ [mm]	M12	M16
Length of the screw (min/max)	L [mm]	140/165	185/205

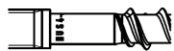
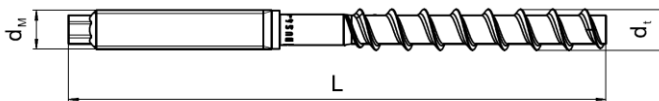

E.g. HUS4-A 10x165



**HUS4:** Hilti Universal Screw 4<sup>th</sup> generation  
**A:** Threaded head  
**10:** Screw diameter  
**100:** total length of the screw  
**8:** carbon steel 8.8  
**K:** length of the screw (more info in ETA)

**Setting information**
**Setting details**

Anchor size		10		12	14		16
Type	HUS4	H(F), C, A(F)	HR, CR	H	H(F), A(F)	HR	H(F), A(F)
Nominal embedment depth	[mm]	$h_{nom3}$	$h_{nom3}$	$h_{nom3}$	$h_{nom3}$	$h_{nom3}$	$h_{nom3}$
		85	90	100	115	110	130
Nominal diameter of drill	$d_0$	10	10	12	14	14	16
Clearance hole diameter	$d_r \leq$	14	14	16	18	18	20
Wrench size HEX head	SW1	15	15	17	21	21	24
Wrench size Threaded head	SW1	8	-	-	12	-	-
Wrench size for nut on threaded head	SW2	19	-	-	24	-	-
Torx size "C" head	TX	-	50	45	-	-	65
Countersunk head diameter	$d_h$	21	21	-	-	-	-
Depth of drill hole for cleaned hole overhead	$h_1 \geq$	95	100	110	125	120	140
Depth of drill hole for uncleaned hole	$h_1 \geq$	115	120	134	153	148	-

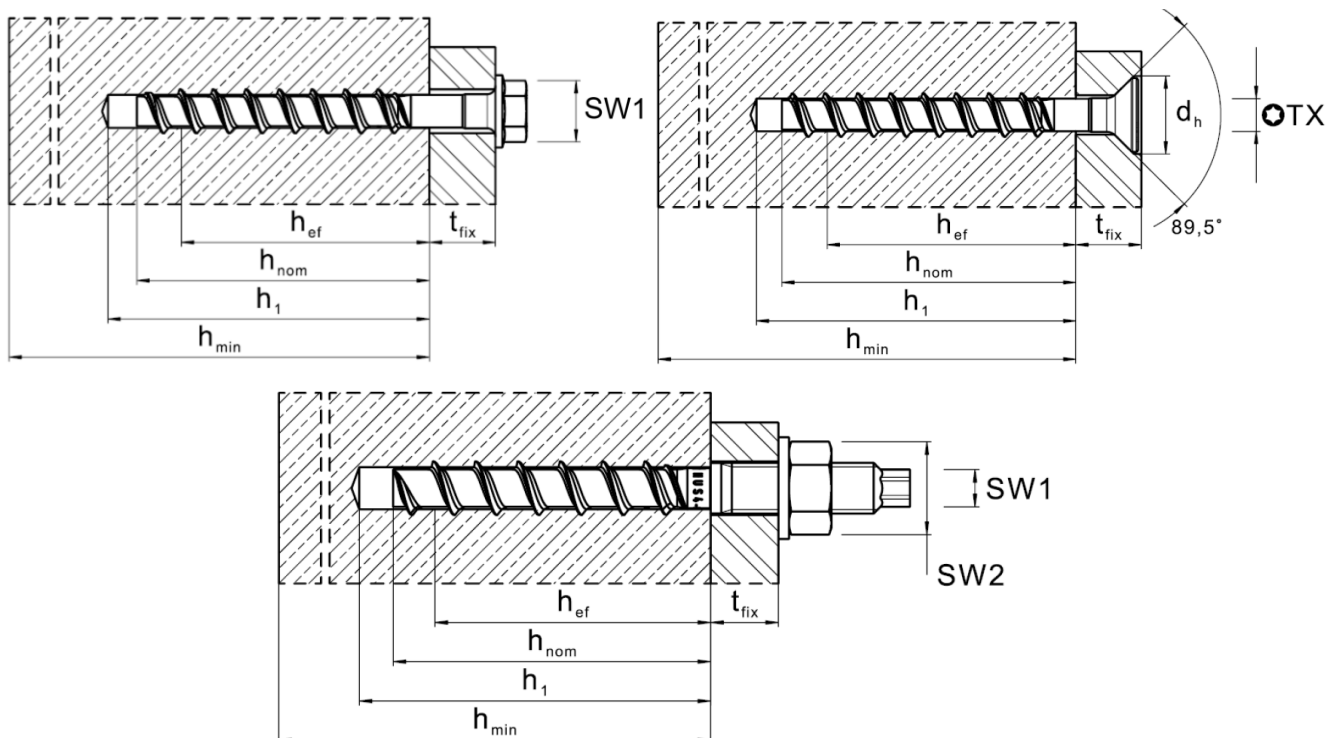

**Installation equipment table (HUS4 H(F), C, A(F)):**

Anchor size	10	12	14	16
Type	HUS4- H(F), C, A(F)	H(F)	H(F), A(F)	H(F)
Rotary hammer	TE4 – TE30			
Diamond drilling rig	DD-30			
Drill bit for concrete	TE-CX 10	TE-CX 12 TE-CD 12	TE-CX 14 TE-CD 14	TE-CX 16
Diamond drilling core bits	SPX-T 10	SPX-T 12	SPX-T 14	-
Socket wrench insert for hex screw	SI-S ½" 15S SI-S ¾" 15S	SI-S ½" 17S SI-S ¾" 17S	SI-S ½" 21S SI-S ¾" 21S	SI-S ½" 24S SI-S ¾" 24S
Socket wrench insert for threaded head screw	SI-S ½" 8S SI-S ¾" 8S	-	SI-S ½" 12S SI-S ¾" 12S	-
Check gauge for reusability <sup>a)</sup>	HRG 10	HRG 12	HRG 14	HRG 16
Torx bit for countersunk	S-SY TX50	-	-	-
Setting tool for cracked and un-cracked concrete	SIW 6AT-A22 ½" SIW 4AT-22 ½" SIW 22T-A ½", ¾" SIW 6-22 ½", SIW 8-22 ½" gear 1 SIW 9-A22 ¾"	SIW 22T-A ½", ¾" SIW 6-22 ½", SIW 8-22 ½" SIW 9-A22 ¾"		

a) For HUS4-A and HUS4-H

**Installation equipment table (HUS4 HR, CR):**

Anchor size	10	14
Type	HUS4- HR, CR	HR
Rotary hammer	TE 2 – TE 30	
Drill bit	TE-CX4 (SDS PLUS) 10/22	TE-CX4 (SDS PLUS) 14/22
Socket wrench insert	SI-S 13 ½" (S)	SI-S 13 ½" (S)
Torx (CR type only)	S-SY TX 50	-
Impact screw driver <sup>1)</sup>	SIW 6AT-A22 ½" SIW 4AT-A22 ½" SIW22T-A ½", ¾" SIW6-22 gr.2 ½"	SIW22T-A ½" SIW6-22 gr.2 ½" SIW8-22 gr.1 ½" SIW9-22 ¾"

**Setting parameters**

Anchor size		10		12	14		16
Type	HUS4	H(F), C, A(F)	HR	H	H(F), A(F)	HR	H
Nominal embedment depth	$h_{nom}$ [mm]	85	90	100	115	110	130
Minimum base material thickness	$h_{min}$ [mm]	140	140	160	200	160	195
Minimum spacing	$s_{min}$ [mm]	40	50	50	60	60	90
Minimum edge distance	$c_{min}$ [mm]	40	50	50	60	60	65
Critical spacing for splitting failure	$s_{cr,sp}$ [mm]	272	351	340	423	407	507
Critical edge distance for splitting failure	$c_{cr,sp}$ [mm]	136	176	170	213	204	254
Critical spacing for concrete cone failure	$s_{cr,N}$ [mm]	255	270	300	345	330	390
Critical edge distance for concrete cone failure	$c_{cr,N}$ [mm]	128	135	150	173	165	195

For spacing (edge distance) smaller than critical spacing (critical edge distance ) the design loads have to be reduced (see system design resistance ).

Critical spacing and critical edge distance for splitting failure apply only for non-cracked concrete. For cracked concrete only the critical spacing and critical edge distance for concrete cone failure are decisive.

**Storage and transport temperature range:**

-20°C to +25°C

**Installation temperature**

-10°C to +40°C

**Service temperature range**

HUS4-MAX anchors may be applied in the temperature range given below.

Temperature range	Base material temperature	Max. long term base material temperature	Max. short term base material temperature
Temperature range I	-40 °C to +120 °C	+72 °C	+120 °C

**Max short term base material temperature**

Short-term elevated base material temperatures are those that occur over brief intervals, e.g. as a result of diurnal cycling.

**Max long term base material temperature**

Long-term elevated base material temperatures are roughly constant over significant periods of time



**Setting instructions**

\*For detailed information on installation see instruction for use given with the package of the product

**Setting instruction - H(F), C, A(F), HR, CR**

**1a. Hammer drilling:**

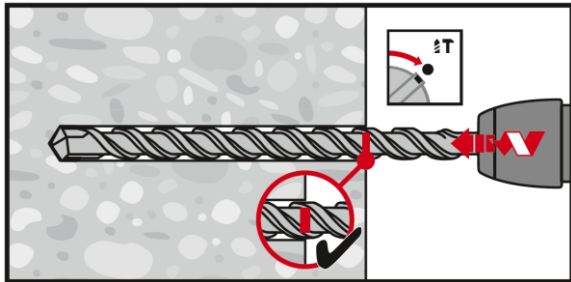

**1b. Hollow drill bit (HUS4-H(F) and HUS4-C(F)):**

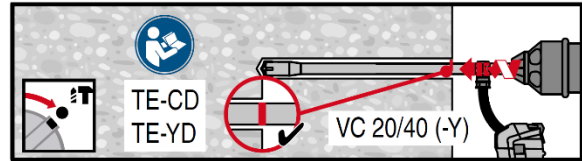

**2a. Cleaning:**

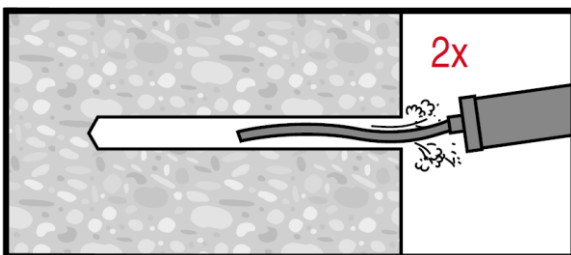

Cleaning needed in downward and horizontal installation direction with drill hole depth  $h_{nom} + 10mm$

Not needed if hammer drilling with Hilti hollow drill bit.

**2b. Non-cleaning – 3x ventilation**

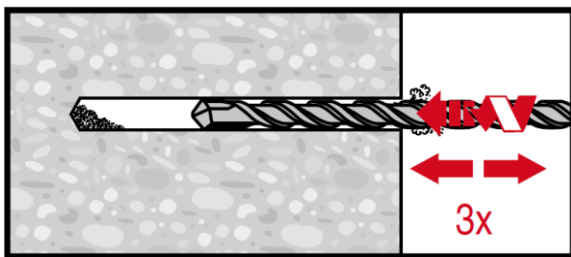

No cleaning is allowed in upward installation direction. No cleaning is allowed in downward and horizontal installation direction when 3x ventilation<sup>1)</sup> after drilling is executed.

Drill hole depth  $h_{nom} + 10 mm + 2 * d_0$

<sup>1)</sup> moving the drill bit in and out of the drill hole 3 times after the recommended drilling depth  $h_1$  is achieved. This procedure shall be done with both revolution and hammer functions activated in the drilling machine. For more details read the relevant installation instruction (MPII).

**3. Insert capsule in borehole**

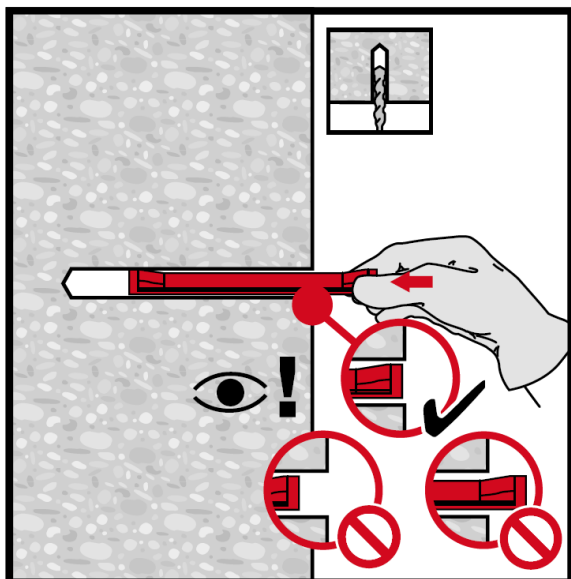

**4. Setting by impact screw driver**

(H(F), C, HR, CR)

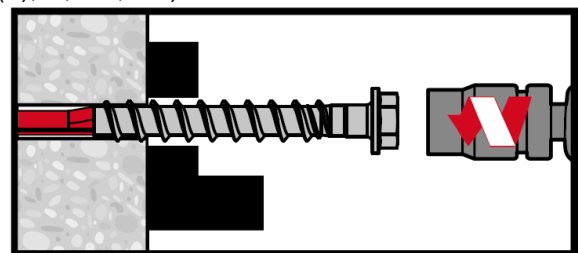

A(F)

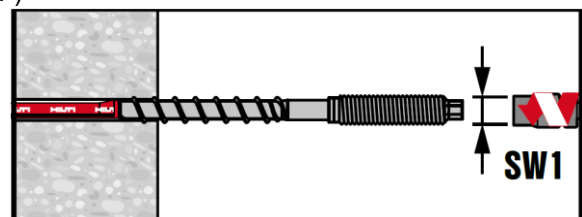

**5a. Setting check – H(F), C, HR, CR**

**5b. load anchor – A(F)**

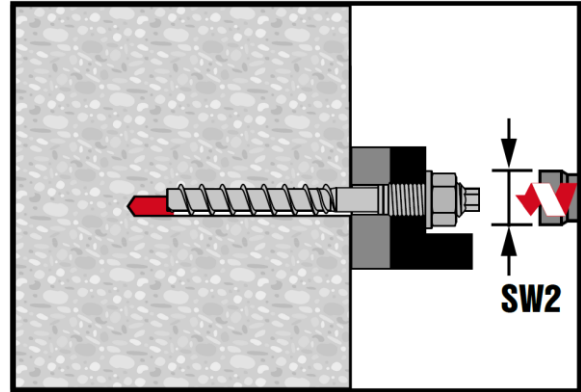
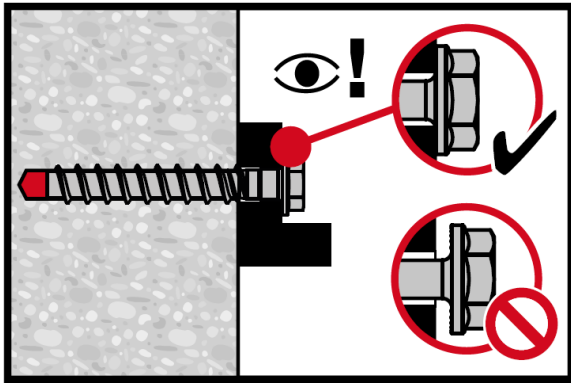

**Optional – screw adjustability (only H(F), C, A(F) versions)**

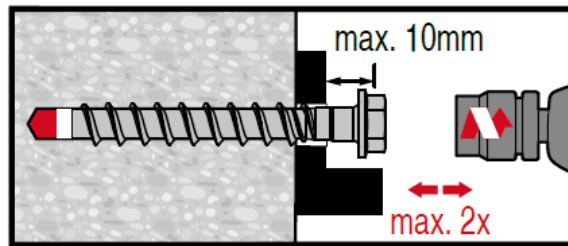

**Full removability and reusability of the fastening point (H(F), C, A(F))**

1. Wait at least 24h after first installation:

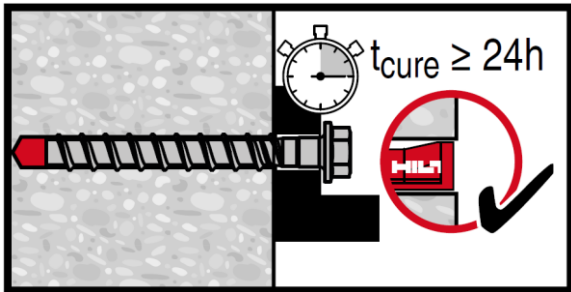

2. remove completely using setting tool:

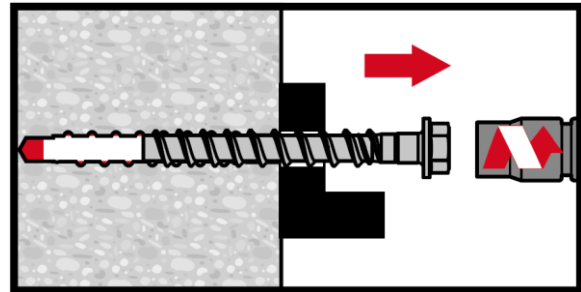

3. Re-insert in borehole by hand:

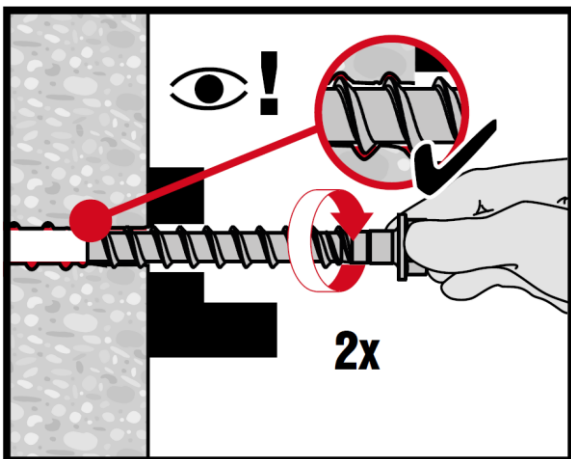

4. Complete setting by impact screw driver:

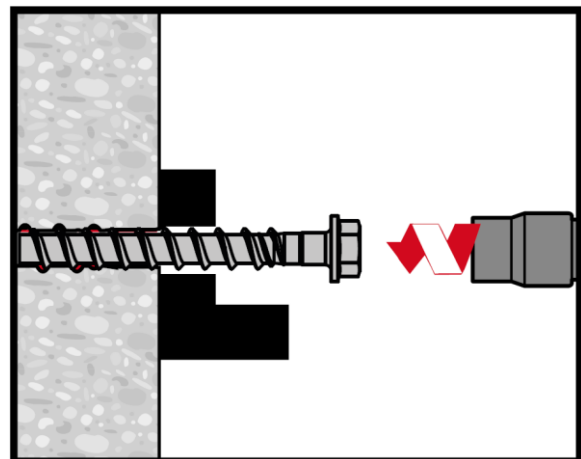



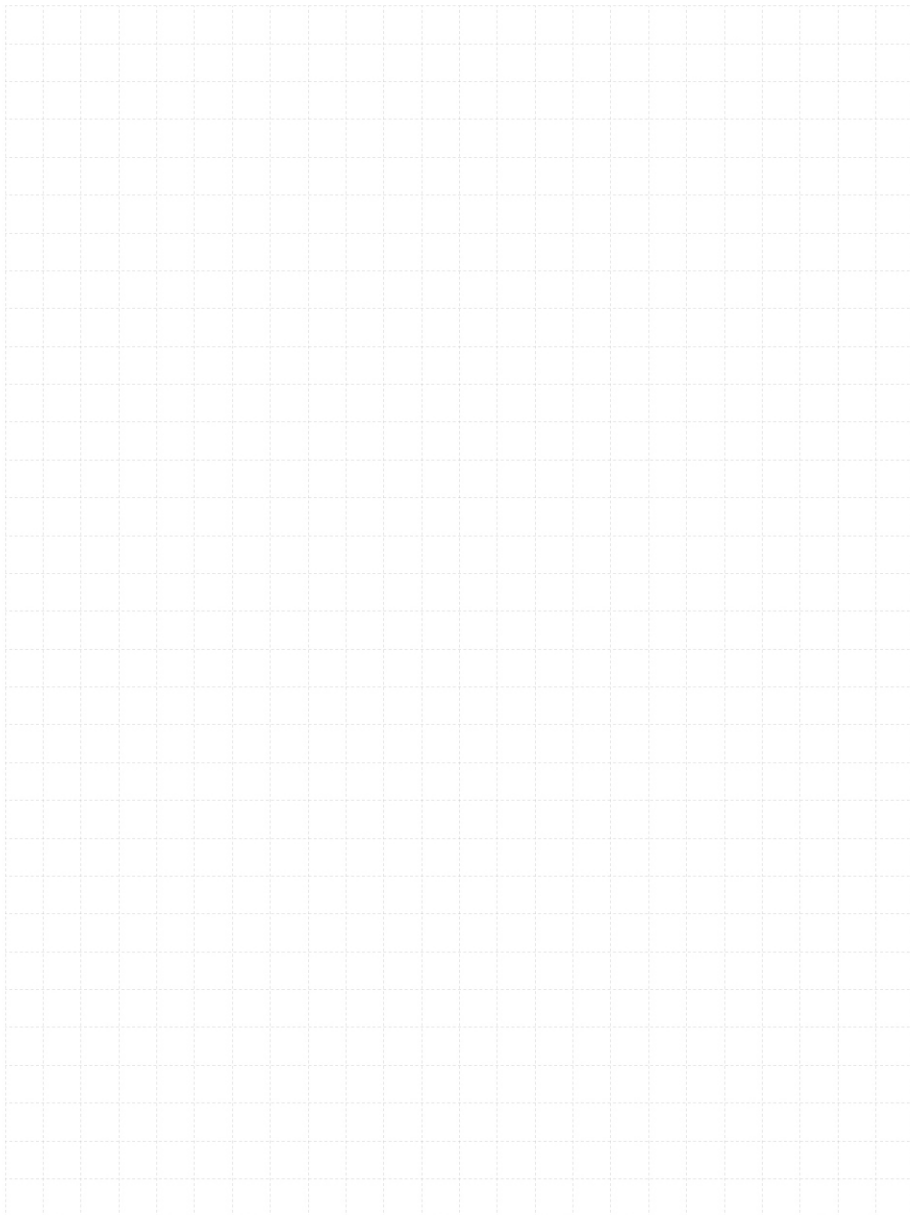











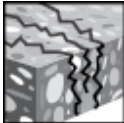
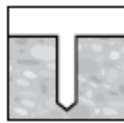
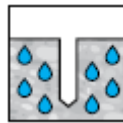

## 2.1.13 HVU2

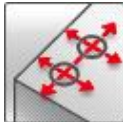

# HVU2 adhesive capsule

## Anchor design (EN 1992-4) / Rods and Sleeves / Concrete

Anchor version	Benefits
 <p>HVU2 Mortar capsule</p>	<ul style="list-style-type: none"> <li>- <b>SafeSet</b> technology: Hilti hollow drill bit for automatic cleaning</li> <li>- Suitable for cracked and non-cracked concrete C20/25 to C50/60 both for hammer drilled and diamond cored holes</li> <li>- Highly reliable and safe anchor for seismic design with ETA C1/C2 approval. Seismic C1 ETA available even for Diamond cored holes.</li> <li>- Clean and fast installation that suits hard jobsite conditions</li> <li>- Suitable for dry and water saturated concrete</li> <li>- High loading capacity</li> <li>- Short curing time</li> <li>- In service temperature range up to 120°C short term / 72°C long term</li> </ul>
 <p>Anchor rod: HAS-U(-P) HAS-U(-P) HDG HAS-U(-P) A4 HAS-U(-P) HCR (M8-M30) (...-M24)</p>	
 <p>Internally threaded sleeve: HIS-N HIS-RN (M8-M20)</p>	

Base material	Load conditions
 Concrete (non-cracked)  Concrete (cracked)  Dry concrete  Wet concrete	 Static/quasi-static  Fire resistance  Seismic ETA-C1/C2
Installation conditions	Other information
 Hammer drilled holes  Diamond drilled holes  Hilti <b>SafeSet</b> technology  Small edge distance and spacing	 European Technical Assessment  CE conformity  PROFIS Engineering design Software  <b>A4 316</b> Corrosion resistance  <b>HCR highMo</b> High corrosion resistance

### Approvals / certificates

Description	Authority / Laboratory	No. / date of issue
European Technical Assessment <sup>a)</sup>	DIBt, Berlin	ETA-16/0515 / 2022-08-23
Fire test assessment	ING.Thiele, Pirmasens	21735 / 2017-08-01

a) All data given in this section according to ETA-16/0515, issue 2022-08-23.

**Static and quasi-static resistance (for a single anchor)**
**All data in this section applies to:**

- Correct setting (See setting instructions)
- No edge distance and spacing influence
- Steel failure
- Minimum base material thickness
- Concrete C20/25,  $f_{ck,cube} = 25 \text{ N/mm}^2$
- In-service temperature range I: -40 °C to +40 °C  
(max. long term temperature +24 °C and max. short term temperature +40 °C)
- Short term loading. For long term loading please apply  $\psi_{sus}$ .  
Hammer drilled holes and Hammer drilled holes with Hollow Drill Bit:  $\psi_{sus} = 1.00$   
Diamond cored holes:  $\psi_{sus} = 0.78$

**Embedment depth and base material thickness**

Anchor size		M8	M10	M12	M16	M20	M24	M27	M30			
<b>HAS-U</b>												
Effective anchorage depth	$h_{ef}$ [mm]	80	90	135	110	165	125	190	170	210	240	270
Base material thickness	$h_{min}$ [mm]	110	120	165	140	195	160	230	220	270	300	340
<b>HIS-N</b>												
Effective anchorage depth	$h_{ef}$ [mm]	90	110	125	170	205	-	-	-	-	-	-
Base material thickness	$h_{min}$ [mm]	120	150	170	230	270	-	-	-	-	-	-

**Hammer drilled holes and hammer drilled holes with hollow drill bit<sup>1)</sup>:**
**Characteristic resistance**

Anchor size		M8	M10	M12	M16	M20	M24	M27	M30			
<b>Non-cracked concrete</b>												
Tension	HAS-U(-P) 5.8	18,3	29,0	29,0	42,2	42,2	68,8	78,5	109,0	149,7	-	-
	HAS-U(-P) 8.8	24,1	42,0	46,4	56,8	67,4	68,8	125,6	109,0	149,7	182,9	218,2
	HAS-U(-P) A4	24,1	40,6	40,6	56,8	59,0	68,8	109,9	109,0	149,7	182,9	218,2
	HAS-U(-P) HCR	24,1	42,0	46,4	56,8	67,4	68,8	125,6	109,0	149,7	-	-
	HIS-N 8.8	25,0	46,0	67,0	109,0	116,0	-	-	-	-	-	-
	HIS-RN 70	26,0	46,0	59,0	109,0	144,4	-	-	-	-	-	-
Shear	HAS-U(-P) 5.8	9,2	14,5	14,5	21,1	21,1	39,3	39,3	61,3	88,3	-	-
	HAS-U(-P) 8.8	14,6	23,2	23,2	33,7	33,7	62,8	62,8	98,0	141,2	183,6	224,4
	HAS-U(-P) A4	12,8	20,3	20,3	29,5	29,5	55,0	55,0	85,8	123,6	114,8	140,3
	HAS-U(-P) HCR	14,6	23,2	23,2	33,7	33,7	62,8	62,8	98,0	123,6	-	-
	HIS-N 8.8	13,0	23,0	34,0	63,0	58,0	-	-	-	-	-	-
	HIS-RN 70	13,0	20,0	30,0	55,0	83,0	-	-	-	-	-	-
<b>Cracked concrete</b>												
Tension	HAS-U(-P) 5.8	10,1	24,0	29,0	35,2	42,2	48,1	78,5	76,3	104,8	-	-
	HAS-U(-P) 8.8	10,1	24,0	36,0	35,2	52,9	48,1	81,2	76,3	104,8	128,0	152,8
	HAS-U(-P) A4	10,1	24,0	36,0	35,2	52,9	48,1	81,2	76,3	104,8	128,0	152,8
	HAS-U(-P) HCR	10,1	24,0	36,0	35,2	52,9	48,1	81,2	76,3	104,8	-	-
	HIS-N 8.8	23,0	37,1	48,1	76,3	101,1	-	-	-	-	-	-
	HIS-RN 70	23,0	37,1	48,1	76,3	101,1	-	-	-	-	-	-
Shear	HAS-U(-P) 5.8	9,2	14,5	14,5	21,1	21,1	39,3	39,3	61,3	88,3	-	-
	HAS-U(-P) 8.8	14,6	23,2	23,2	33,7	33,7	62,8	62,8	98,0	141,2	183,6	224,4
	HAS-U(-P) A4	12,8	20,3	20,3	29,5	29,5	55,0	55,0	85,8	123,6	114,8	140,3
	HAS-U(-P) HCR	14,6	23,2	23,2	33,7	33,7	62,8	62,8	98,0	123,6	-	-
	HIS-N 8.8	13,0	23,0	34,0	63,0	58,0	-	-	-	-	-	-
	HIS-RN 70	13,0	20,0	30,0	55,0	83,0	-	-	-	-	-	-

1) Hilti hollow drill bit is available for the element sizes M12 to M30.

**Design resistance**

Anchor size		M8	M10	M12	M16	M20	M24	M27	M30			
<b>Non-cracked concrete</b>												
Tension	HAS-U(-P) 5.8	12,2	19,3	19,3	28,1	28,1	45,8	52,3	72,7	99,8	-	-
	HAS-U(-P) 8.8	16,1	28,0	30,9	37,8	45,0	45,8	83,9	72,7	99,8	121,9	145,5
	HAS-U(-P) A4	13,7	21,7	21,7	31,6	31,6	45,8	58,8	72,7	99,8	80,2	98,1
	HAS-U(-P) HCR	16,1	28,0	30,9	37,8	45,0	45,8	83,7	72,7	99,8	-	-
	HIS-N 8.8	16,7	30,7	44,7	72,7	77,3	-	-	-	-	-	-
	HIS-RN 70	13,9	21,9	31,6	58,8	69,2	-	-	-	-	-	-
Shear	HAS-U(-P) 5.8	7,3	11,6	11,6	16,9	16,9	31,4	31,4	49,0	70,6	-	-
	HAS-U(-P) 8.8	11,7	18,6	18,6	27,0	27,0	50,2	50,2	78,4	113,0	146,9	179,5
	HAS-U(-P) A4	9,2	14,5	14,5	21,1	21,1	39,3	39,3	55,0	79,2	48,2	58,9
	HAS-U(-P) HCR	11,7	18,6	18,6	27,0	27,0	50,2	50,2	78,4	70,6	-	-
	HIS-N 8.8	10,4	18,4	27,2	50,4	46,4	-	-	-	-	-	-
	HIS-RN 70	8,3	12,8	19,2	35,3	41,5	-	-	-	-	-	-
<b>Cracked concrete</b>												
Tension	HAS-U(-P) 5.8	6,7	16,0	19,3	23,5	28,1	32,1	52,3	50,9	69,9	-	-
	HAS-U(-P) 8.8	6,7	16,0	24,0	23,5	35,2	32,1	54,1	50,9	69,9	85,4	102
	HAS-U(-P) A4	6,7	16,0	21,7	23,5	31,6	32,1	54,1	50,9	69,9	80,2	98,1
	HAS-U(-P) HCR	6,7	16,0	24,0	23,5	35,2	32,1	54,1	50,9	69,9	-	-
	HIS-N 8.8	15,3	24,7	32,1	50,9	67,4	-	-	-	-	-	-
	HIS-RN 70	13,9	21,9	31,6	50,9	67,4	-	-	-	-	-	-
Shear	HAS-U(-P) 5.8	7,3	11,6	11,6	16,9	16,9	31,4	31,4	49,0	70,6	-	-
	HAS-U(-P) 8.8	11,7	18,6	18,6	27,0	27,0	50,2	50,2	78,4	113,0	146,9	179,5
	HAS-U(-P) A4	9,2	14,5	14,5	21,1	21,1	39,3	39,3	55,0	79,2	48,2	58,9
	HAS-U(-P) HCR	11,7	18,6	18,6	27,0	27,0	50,2	50,2	78,4	70,6	-	-
	HIS-N 8.8	10,4	18,4	27,2	50,4	46,4	-	-	-	-	-	-
	HIS-RN 70	8,3	12,8	19,2	35,3	41,5	-	-	-	-	-	-

1) Hilti hollow drill bit is available for the element sizes M12 to M30.

**Recommended loads<sup>2)</sup>**

Anchor size		M8	M10	M12	M16	M20	M24	M27	M30			
<b>Non-cracked concrete</b>												
Tension	HAS-U(-P) 5.8	8,7	13,8	13,8	20,1	20,1	32,7	37,4	51,9	71,3	-	-
	HAS-U(-P) 8.8	11,5	20,0	22,1	27,0	32,1	32,7	59,8	51,9	71,3	87,1	103,9
	HAS-U(-P) A4	9,8	15,5	15,5	22,5	22,5	32,7	42,0	51,9	71,3	57,3	70,1
	HAS-U(-P) HCR	11,5	20,0	22,1	27,0	32,1	32,7	59,8	51,9	71,3	-	-
	HIS-N 8.8	11,9	21,9	31,9	51,9	55,2	-	-	-	-	-	-
	HIS-RN 70	9,9	15,7	22,5	42,0	49,4	-	-	-	-	-	-
Shear	HAS-U(-P) 5.8	5,2	8,3	8,3	12,0	12,0	22,4	22,4	35,0	50,4	-	-
	HAS-U(-P) 8.8	8,4	13,3	13,3	19,3	19,3	35,9	35,9	56,0	80,7	104,9	128,2
	HAS-U(-P) A4	6,5	10,4	10,4	15,1	15,1	28,0	28,0	39,3	56,6	34,4	42,1
	HAS-U(-P) HCR	8,4	13,3	13,3	19,3	19,3	35,9	35,9	56,0	50,4	-	-
	HIS-N 8.8	7,4	13,1	19,4	36,0	33,1	-	-	-	-	-	-
	HIS-RN 70	6,0	9,2	13,7	25,2	29,6	-	-	-	-	-	-
<b>Cracked concrete</b>												
Tension	HAS-U(-P) 5.8	4,8	11,4	13,8	16,8	20,1	22,9	37,4	36,3	49,9	-	-
	HAS-U(-P) 8.8	4,8	11,4	17,2	16,8	25,2	22,9	38,7	36,3	49,9	61,0	72,7
	HAS-U(-P) A4	4,8	11,4	15,5	16,8	22,5	22,9	38,7	36,3	49,9	57,3	70,1
	HAS-U(-P) HCR	4,8	11,4	17,2	16,8	25,2	22,9	38,7	36,3	49,9	-	-
	HIS-N 8.8	10,9	17,6	22,9	36,3	48,1	-	-	-	-	-	-
	HIS-RN 70	9,9	15,7	22,5	36,3	48,1	-	-	-	-	-	-
Shear	HAS-U(-P) 5.8	5,2	8,3	8,3	12,0	12,0	22,4	22,4	35,0	50,4	-	-
	HAS-U(-P) 8.8	8,4	13,3	13,3	19,3	19,3	35,9	35,9	56,0	80,7	104,9	128,2
	HAS-U(-P) A4	6,5	10,4	10,4	15,1	15,1	28,0	28,0	39,3	56,6	34,4	42,1
	HAS-U(-P) HCR	8,4	13,3	13,3	19,3	19,3	35,9	35,9	56,0	50,4	-	-
	HIS-N 8.8	7,4	13,1	19,4	36,0	33,1	-	-	-	-	-	-
	HIS-RN 70	6,0	9,2	13,7	25,2	29,6	-	-	-	-	-	-

1) Hilti hollow drill bit is available for the element sizes M12-M30.

 2) With overall partial safety factor for action  $\gamma = 1,4$ . The partial safety factors for action depend on the type of loading and shall be taken from national regulations.



**Diamond cored holes:**
**Characteristic resistance**

Anchor size		M8	M10	M12	M16	M20	M24	M27	M30			
<b>Non-cracked concrete</b>												
Tension	HAS-U(-P) 5.8	-	29,0	29,0	42,2	42,2	68,8	78,5	109,0	149,7	-	-
	HAS-U(-P) 8.8	-	39,6	46,4	56,8	67,4	68,8	125,6	109,0	149,7	182,9	218,2
	HAS-U(-P) A4	-	39,6	40,6	56,8	59,0	68,8	109,9	109,0	149,7	182,9	218,2
	HAS-U(-P) HCR	-	39,6	46,4	56,8	67,4	68,8	125,6	109,0	149,7	-	-
	HIS-N 8.8	25,0	46,0		67,0		109,0		116,0	-	-	-
	HIS-RN 70	26,0	41,0		59,0		109,0		144,4	-	-	-
Shear	HAS-U(-P) 5.8	-	14,5	14,5	21,1	21,1	39,3	39,3	61,3	88,3	-	-
	HAS-U(-P) 8.8	-	23,2	23,2	33,7	33,7	62,8	62,8	98,0	141,2	183,6	224,4
	HAS-U(-P) A4	-	20,3	20,3	29,5	29,5	55,0	55,0	85,8	123,6	114,8	140,3
	HAS-U(-P) HCR	-	23,2	23,2	33,7	33,7	62,8	62,8	98,0	123,6	-	-
	HIS-N 8.8	13,0	23,0		34,0		63,0		58,0	-	-	-
	HIS-RN 70	13,0	20,0		30,0		55,0		83,0	-	-	-
<b>Cracked concrete</b>												
Tension	HAS-U(-P) 5.8	-	19,8	29,0	29,0	42,2	44,0	66,9	74,8	104,8	-	-
	HAS-U(-P) 8.8	-	19,8	29,7	29,0	43,5	44,0	66,9	74,8	104,8	128,0	152,8
	HAS-U(-P) A4	-	19,8	29,7	29,0	43,5	44,0	66,9	74,8	104,8	128,0	152,8
	HAS-U(-P) HCR	-	19,8	29,7	29,0	43,5	44,0	66,9	74,8	104,8	-	-
	HIS-N 8.8	15,9	25,7		36,2		61,0		80,0	-	-	-
	HIS-RN 70	15,9	25,7		36,2		61,0		80,0	-	-	-
Shear	HAS-U(-P) 5.8	-	14,5	14,5	21,1	21,1	39,3	39,3	61,3	88,3	-	-
	HAS-U(-P) 8.8	-	23,2	23,2	33,7	33,7	62,8	62,8	98,0	141	184	224
	HAS-U(-P) A4	-	20,3	20,3	29,5	29,5	55,0	55,0	85,8	124	115	140
	HAS-U(-P) HCR	-	23,2	23,2	33,7	33,7	62,8	62,8	98,0	124	-	-
	HIS-N 8.8	13,0	23,0		34,0		63,0		58,0	-	-	-
	HIS-RN 70	13,0	20,0		30,0		55,0		83,0	-	-	-

**Design resistance**

Anchor size		M8	M10	M12	M16	M20	M24	M27	M30			
<b>Non-cracked concrete</b>												
Tension	HAS-U(-P) 5.8	-	19,3	19,3	28,1	28,1	45,8	52,3	72,7	99,8	-	-
	HAS-U(-P) 8.8	-	26,4	30,9	37,8	45,0	45,8	83,7	72,7	99,8	121,9	145,5
	HAS-U(-P) A4	-	24,2	21,7	31,6	31,6	45,8	58,8	72,7	99,8	80,2	98,1
	HAS-U(-P) HCR	-	26,4	30,9	37,8	45,0	45,8	83,7	72,7	99,8	-	-
	HIS-N 8.8	16,7	30,7		44,7		72,7		77,3	-	-	-
	HIS-RN 70	13,9	21,9		31,6		58,8		69,2	-	-	-
Shear	HAS-U(-P) 5.8	-	11,6	11,6	16,9	16,9	31,4	31,4	49,0	70,6	-	-
	HAS-U(-P) 8.8	-	18,6	18,6	27,0	27,0	50,2	50,2	78,4	113,0	146,9	179,5
	HAS-U(-P) A4	-	14,5	14,5	21,1	21,1	39,3	39,3	55,0	79,2	48,2	58,9
	HAS-U(-P) HCR	-	18,6	18,6	27,0	27,0	50,2	50,2	78,4	70,6	-	-
	HIS-N 8.8	10,4	18,4		27,2		50,4		46,4	-	-	-
	HIS-RN 70	8,3	12,8		19,2		35,3		41,5	-	-	-
<b>Cracked concrete</b>												
Tension	HAS-U(-P) 5.8	-	13,2	19,3	19,4	28,1	29,3	44,6	49,8	69,9	-	-
	HAS-U(-P) 8.8	-	13,2	19,8	19,4	29,0	29,3	44,6	49,8	69,9	85,4	101,8
	HAS-U(-P) A4	-	13,2	19,8	19,4	29,0	29,3	44,6	49,8	69,9	80,2	98,1
	HAS-U(-P) HCR	-	13,2	19,8	19,4	29,0	29,3	44,6	49,8	69,9	-	-
	HIS-N 8.8	10,6	17,1		24,2		40,7		53,3	-	-	-
	HIS-RN 70	10,6	17,1		24,2		40,7		53,3	-	-	-
Shear	HAS-U(-P) 5.8	-	11,6	11,6	16,9	16,9	31,4	31,4	49,0	70,6	-	-
	HAS-U(-P) 8.8	-	18,6	18,6	27,0	27,0	50,2	50,2	78,4	113,0	146,9	179,5
	HAS-U(-P) A4	-	14,5	14,5	21,1	21,1	39,3	39,3	55,0	79,2	48,2	58,9
	HAS-U(-P) HCR	-	18,6	18,6	27,0	27,0	50,2	50,2	78,4	70,6	-	-
	HIS-N 8.8	10,4	18,4		27,2		50,4		46,4	-	-	-
	HIS-RN 70	8,3	12,8		19,2		35,3		41,5	-	-	-

**Recommended loads <sup>a)</sup>**

Anchor size		M8	M10	M12	M16	M20	M24	M27	M30			
<b>Non-cracked concrete</b>												
Tension	HAS-U(-P) 5.8	-	13,8	13,8	20,1	20,1	32,7	37,4	51,9	71,3	-	-
	HAS-U(-P) 8.8	-	18,8	22,1	27,0	32,1	32,7	59,8	51,9	71,3	87,1	103,9
	HAS-U(-P) A4	-	15,5	15,5	22,5	22,5	32,7	42,0	51,9	71,3	57,3	70,1
	HAS-U(-P) HCR	-	18,8	22,1	27,0	32,1	32,7	59,8	51,9	71,3	-	-
	HIS-N 8.8	11,9	21,9		31,9		51,9		55,2	-	-	-
	HIS-RN 70	9,9	15,7		22,5		42,0		49,4	-	-	-
Shear	HAS-U(-P) 5.8	-	8,3	8,3	12,0	12,0	22,4	22,4	35,0	50,4	-	-
	HAS-U(-P) 8.8	-	13,3	13,3	19,3	19,3	35,9	35,9	56,0	80,7	104,9	128,2
	HAS-U(-P) A4	-	10,4	10,4	15,1	15,1	28,0	28,0	39,3	56,6	34,4	42,1
	HAS-U(-P) HCR	-	13,3	13,3	19,3	19,3	35,9	35,9	56,0	50,4	-	-
	HIS-N 8.8	7,4	13,1		19,4		36,0		33,1	-	-	-
	HIS-RN 70	6,0	9,2		13,7		25,2		29,6	-	-	-
<b>Cracked concrete</b>												
Tension	HAS-U(-P) 5.8	-	9,4	13,8	13,8	20,1	20,9	31,8	35,6	49,9	-	-
	HAS-U(-P) 8.8	-	9,4	14,1	13,8	20,7	20,9	31,8	35,6	49,9	61,0	72,7
	HAS-U(-P) A4	-	9,4	14,1	13,8	20,7	20,9	31,8	35,6	49,9	57,3	70,1
	HAS-U(-P) HCR	-	9,4	14,1	13,8	20,7	20,9	31,8	35,6	49,9	-	-
	HIS-N 8.8	7,6	12,2		17,3		29,1		38,1	-	-	-
	HIS-RN 70	7,6	12,2		17,3		29,1		38,1	-	-	-
Shear	HAS-U(-P) 5.8	-	8,3	8,3	12,0	12,0	22,4	22,4	35,0	50,4	-	-
	HAS-U(-P) 8.8	-	13,3	13,3	19,3	19,3	35,9	35,9	56,0	80,7	104,9	128,2
	HAS-U(-P) A4	-	10,4	10,4	15,1	15,1	28,0	28,0	39,3	56,6	34,4	42,1
	HAS-U(-P) HCR	-	13,3	13,3	19,3	19,3	35,9	35,9	56,0	50,4	-	-
	HIS-N 8.8	7,4	13,1		19,4		36,0		33,1	-	-	-
	HIS-RN 70	6,0	9,2		13,7		25,2		29,6	-	-	-

a) With overall partial safety factor for action  $\gamma = 1,4$ . The partial safety factors for action depend on the type of loading and shall be taken from national regulations.



## Seismic resistance

### All data in this section applies to:

- Hammer drilled holes and hammer drilled holes with hollow drill bit
- Correct setting (See setting instructions)
- No edge distance and spacing influence
- Steel failure
- Minimum base material thickness
- Concrete C20/25,  $f_{ck,cube} = 25 \text{ N/mm}^2$
- $\alpha_{gap} = 1,0$  (using Hilti seismic filling set) or  $\alpha_{gap} = 0,5$  (without using Hilti seismic filling set) accordingly
- In-service temperature range I:  $-40 \text{ °C}$  to  $+40 \text{ °C}$   
(max. long term temperature  $+24 \text{ °C}$  and max. short term temperature  $+40 \text{ °C}$ )

### Embedment depth and base material thickness

Anchor size			M8	M10	M12	M16	M20	M24	M27	M30			
<b>HAS-U(-P)</b>													
Effective anchorage depth	$h_{ef}$	[mm]	80	90	135	110	165	125	190	170	210	240	270
Base material thickness	$h_{min}$	[mm]	110	120	165	140	195	160	230	220	270	300	340

### Characteristic resistance

Anchor size			M8	M10	M12	M16	M20	M24	M27	M30			
<b>Seismic performance C1</b>													
Tension	HAS-U(-P) 5.8	$N_{Rk,seis}$ [kN]	-	24,0	29,0	33,8	42,2	40,9	76,7	64,9	89,1	-	-
	HAS-U(-P) 8.8		-	24,0	36,0	33,8	52,8	40,9	76,7	64,9	89,1	108,8	129,9
	HAS-U(-P) A4		-	24,0	36,0	33,8	52,8	40,9	76,7	64,9	89,1	108,8	129,9
	HAS-U(-P) HCR		-	24,0	36,0	33,8	52,8	40,9	76,7	64,9	89,1	-	-
<b>with Hilti filling set (<math>\alpha_{gap} = 1,0</math>)</b>													
Shear	HAS-U(-P) 5.8	$V_{Rk,seis}$ [kN]	-	11,0	11,0	15,0	15,0	27,0	27,0	43,0	62,0	-	-
	HAS-U(-P) 8.8		-	16,0	16,0	24,0	24,0	44,0	44,0	69,0	99,0	129,0	157,0
	HAS-U(-P) A4		-	14,0	14,0	21,0	21,0	39,0	39,0	60,0	87,0	81,0	98,0
	HAS-U(-P) HCR		-	16,0	16,0	24,0	24,0	44,0	44,0	69,0	87,0	-	-
<b>without Hilti filling set (<math>\alpha_{gap} = 0,5</math>)</b>													
Shear	HAS-U(-P) 5.8	$V_{Rk,seis}$ [kN]	-	5,5	5,5	7,5	7,5	13,5	13,5	21,5	31,0	-	-
	HAS-U(-P) 8.8		-	8,0	8,0	12,0	12,0	22,0	22,0	34,5	49,5	64,5	78,5
	HAS-U(-P) A4		-	7,0	7,0	10,5	10,5	19,5	19,5	30,0	43,5	40,5	49,0
	HAS-U(-P) HCR		-	8,0	8,0	12,0	12,0	22,0	22,0	34,5	43,5	-	-

### Design resistance

Anchor size			M8	M10	M12	M16	M20	M24	M27	M30			
<b>Seismic performance C1</b>													
Tension	HAS-U(-P) 5.8	$N_{Rd,seis}$ [kN]	-	16,0	19,3	22,5	28,1	27,3	51,1	43,3	59,4	-	-
	HAS-U(-P) 8.8		-	16,0	24,0	22,5	35,2	27,3	51,1	43,3	59,4	72,6	86,6
	HAS-U(-P) A4		-	16,0	21,7	22,5	31,6	27,3	51,1	43,3	59,4	72,6	86,6
	HAS-U(-P) HCR		-	16,0	24,0	22,5	35,2	27,3	51,1	43,3	59,4	-	-
<b>with Hilti filling set (<math>\alpha_{gap} = 1,0</math>)</b>													
Shear	HAS-U(-P) 5.8	$V_{Rd,seis}$ [kN]	-	8,8	8,8	12,0	12,0	21,6	21,6	34,4	49,6	-	-
	HAS-U(-P) 8.8		-	12,8	12,8	19,2	19,2	35,2	35,2	55,2	79,2	103,2	125,6
	HAS-U(-P) A4		-	9,0	9,0	13,5	13,5	25,0	25,0	38,5	55,8	34,0	41,2
	HAS-U(-P) HCR		-	12,8	12,8	19,2	19,2	35,2	35,2	55,2	49,7	-	-
<b>without Hilti filling set (<math>\alpha_{gap} = 0,5</math>)</b>													
Shear	HAS-U(-P) 5.8	$V_{Rd,seis}$ [kN]	-	4,4	4,4	6,0	6,0	10,8	10,8	17,2	24,8	-	-
	HAS-U(-P) 8.8		-	6,4	6,4	9,6	9,6	17,6	17,6	27,6	39,6	51,6	62,8
	HAS-U(-P) A4		-	4,5	4,5	6,7	6,7	12,5	12,5	19,2	27,9	17,0	20,6
	HAS-U(-P) HCR		-	6,4	6,4	9,6	9,6	17,6	17,6	27,6	24,9	-	-

**Characteristic resistance**

Anchor size			M8	M10	M12	M16	M20	M24	M27	M30
<b>Seismic performance C2</b>										
Tension	HAS-U(-P) 8.8	$N_{Rk,seis}$ [kN]	-	-	-	18,2	27,7	27,8	-	-
<b>with Hilti filling set (<math>\alpha_{gap} = 1,0</math>)</b>										
Shear	HAS-U(-P) 8.8	$V_{Rk,seis}$ [kN]	-	-	-	40,0	40,0	71,0	-	-
<b>without Hilti filling set (<math>\alpha_{gap} = 0,5</math>)</b>										
Shear	HAS-U(-P) 8.8	$V_{Rk,seis}$ [kN]	-	-	-	20,0	20,0	35,5	-	-

**Design resistance**

Anchor size			M8	M10	M12	M16	M20	M24	M27	M30
<b>Seismic performance C2</b>										
Tension	HAS-U(-P) 8.8	$N_{Rd,seis}$ [kN]	-	-	-	12,1	18,5	18,5	-	-
<b>with Hilti filling set (<math>\alpha_{gap} = 1,0</math>)</b>										
Shear	HAS-U(-P) 8.8	$V_{Rd,seis}$ [kN]	-	-	-	32,0	32,0	56,8	-	-
<b>without Hilti filling set (<math>\alpha_{gap} = 0,5</math>)</b>										
Shear	HAS-U(-P) 8.8	$V_{Rd,seis}$ [kN]	-	-	-	16,0	16,0	28,4	-	-

## Fire resistance

### All data in this section applies to:

- Correct setting (See setting instruction)
- No edge distance and spacing influence
- Steel failure
- Minimum base material thickness
- Concrete C20/25,  $f_{ck,cube} = 25 \text{ N/mm}^2$
- All data given in this section according to Fire test assessment from Ing. Thiele, Pirmasens 21735 / 2017-08-01

### Embedment depth and base material thickness

Anchor size		M8	M10	M12	M16	M20	M24	M27	M30
<b>HAS-U (-P)</b>									
Effective anchorage depth	$h_{ef}$ [mm]	80	90	110	125	170	210	240	270
Base material thickness	$h_{min}$ [mm]	110	120	140	160	220	270	300	340
<b>HIS-N</b>									
Effective anchorage depth	$h_{ef}$ [mm]	90	110	125	170	205	-	-	-
Base material thickness	$h_{min}$ [mm]	120	150	170	230	270	-	-	-

### Characteristic/design<sup>1</sup> resistance in cracked concrete

Anchor size		M8	M10	M12	M16	M20	M24	M27	M30
<b>Fire Exposure R30</b>									
Tension	HAS-U(-P) 8.8	-	2,90	4,22	7,85	12,2	16,6	23,0	28,0
	HAS-U(-P) A4	-	5,00	9,00	12,8	28,0	40,4	52,5	64,2
	HIS-N 8.8	1,83	2,90	4,22	7,85	12,2	-	-	-
	HIS-RN 70	4,19	6,64	9,65	18,00	28,0	-	-	-
Shear	HAS-U(-P) 8.8	-	2,90	4,22	7,85	12,2	16,6	23,0	28,0
	HAS-U(-P) A4	-	5,00	9,00	12,8	28,0	40,4	52,5	64,2
	HIS-N 8.8	1,83	2,90	4,22	7,85	12,2	-	-	-
	HIS-RN 70	4,19	6,64	9,65	18,00	28,0	-	-	-
<b>Fire Exposure R120</b>									
Tension	HAS-U(-P) 8.8	-	0,35	0,99	1,66	4,40	6,35	8,26	10,1
	HAS-U(-P) A4	-	0,35	1,00	1,66	6,90	10,2	13,3	16,3
	HIS-N 8.8	0,33	0,76	1,30	2,80	4,40	-	-	-
	HIS-RN 70	0,33	0,76	1,31	4,55	7,11	-	-	-
Shear	HAS-U(-P) 8.8	-	0,35	0,99	1,66	4,40	6,35	8,26	10,1
	HAS-U(-P) A4	-	0,35	1,00	1,66	6,90	10,2	13,3	16,3
	HIS-N 8.8	0,33	0,76	1,30	2,80	4,40	-	-	-
	HIS-RN 70	0,33	0,76	1,31	4,55	7,11	-	-	-

1) The safety factor is  $\gamma=1.0$  for all load cases

**Materials**
**Mechanical properties for HAS-U**

Anchor size			M8	M10	M12	M16	M20	M24	M27	M30
Nominal tensile strength	HAS-U (-P) 5.8	$f_{uk}$ [N/mm <sup>2</sup> ]	500	500	500	500	500	500	-	-
	HAS-U (-P) 8.8		800	800	800	800	800	800	800	800
	HAS-U (-P) A4		700	700	700	700	700	700	500	500
	HAS-U (-P) HCR		800	800	800	800	800	700	-	-
Yield strength	HAS-U (-P) 5.8	$f_{yk}$ [N/mm <sup>2</sup> ]	440	440	440	440	400	400	-	-
	HAS-U (-P) 8.8		640	640	640	640	640	640	640	640
	HAS-U (-P) A4		450	450	450	450	450	450	210	210
	HAS-U (-P) HCR		640	640	640	640	640	400	-	-
Stressed cross-section	HAS-U	$A_s$ [mm <sup>2</sup> ]	36,6	58,0	84,3	157	245	353	459	561
Moment of resistance	HAS-U	$W$ [mm <sup>3</sup> ]	31,2	62,3	109	277	541	935	1387	1874

**Mechanical properties for HIS-N**

Anchor size			M8	M10	M12	M16	M20
Nominal tensile strength	HIS-N	$f_{uk}$ [N/mm <sup>2</sup> ]	490	490	490	490	490
	Screw 8.8		800	800	800	800	800
	HIS-RN		700	700	700	700	700
	Screw 70		700	700	700	700	700
Yield strength	HIS-N	$f_{yk}$ [N/mm <sup>2</sup> ]	390	390	390	390	390
	Screw 8.8		640	640	640	640	640
	HIS-RN		350	350	350	350	350
	Screw 70		450	450	450	450	450
Stressed cross-section	HIS-(R)N	$A_s$ [mm <sup>2</sup> ]	51,5	108	169	256	238
	Screw		36,6	58,0	84,3	157	245
Moment of resistance	HIS-(R)N	$W$ [mm <sup>3</sup> ]	145	430	840	1595	1543
	Screw		31,2	62,3	109	277	541

**Material quality for HAS-U**

Part	Material
<b>Metal parts made of zinc coated steel</b>	
HAS-U	M8 to M24 Strength class 5.8: - Rupture elongation ( $l_0 = 5d$ ) > 8% ductile M8 to M30: Strength class 8.8: - Rupture elongation ( $l_0 = 5d$ ) > 12% ductile Electroplated zinc coated $\geq 5 \mu\text{m}$ ; (F) hot dip galvanized $\geq 45 \mu\text{m}$
Washer	Electroplated zinc coated $\geq 5 \mu\text{m}$ ; hot dip galvanized $\geq 45 \mu\text{m}$
Nut	Strength class adapted to strength class of threaded rod. Electroplated zinc coated $\geq 5 \mu\text{m}$ ; hot dip galvanized $\geq 45 \mu\text{m}$
<b>Metal parts made of stainless steel</b>	
HAS-U A4	M8 to M24 Strength class 70: M27 to M30 Strength class 50: - Rupture elongation ( $l_0=5d$ ) > 8% ductile - Stainless steel A4 according to EN 10088-1:2014
Washer	Stainless steel A4 according to EN 10088-1:2014
Nut	Strength class adapted to strength class of threaded rod. Stainless steel A4 according to EN 10088-1:2014
<b>Metal parts made of high corrosion resistant steel</b>	
HAS-U HCR	M8 to M20 Strength class 70: M24 Strength class 80: Rupture elongation ( $l_0 = 5d$ ) > 8% ductile High corrosion resistant steel according to EN 10088-1:2014
Washer	High corrosion resistant steel according to EN 10088-1:2014
Nut	Strength class adapted to strength class of threaded rod High corrosion resistant steel according to EN 10088-1:2014

**Material quality for HIS-N**

Part	Material	
<b>Metal parts made of zinc coated steel</b>		
HIS-N	Internal threaded sleeve	Electroplated zinc coated $\geq 5 \mu\text{m}$
	Screw 8.8	Strength class 8.8, A5 > 8 % Ductile Steel galvanized $\geq 5 \mu\text{m}$
<b>Metal parts made of stainless steel</b>		
HIS-RN	Internal threaded sleeve	Stainless steel A4 according to EN 10088-1:2014
	Screw 70	Strength class 70, A5 > 8 % Ductile Stainless steel 1.4401; 1.4404, 1.4578; 1.4571; 1.4439; 1.4362

## Setting information

### Installation temperature range:

-10°C to +40°C for the standard variation of temperature and rapid variation of temperature after installation.

### In service temperature range

Hilti HVU2 adhesive may be applied in the temperature ranges given below. An elevated base material temperature may lead to a reduction of the design bond resistance.

Temperature range	Base material temperature	Maximum long term base material temperature	Maximum short term base material temperature
Temperature range I	-40 °C to +40 °C	+24 °C	+40 °C
Temperature range II	-40 °C to +80 °C	+50 °C	+80 °C
Temperature range III	-40 °C to +120 °C	+72 °C	+120 °C

### Maximum short term base material temperature

Short-term elevated base material temperatures are those that occur over brief intervals, e.g. as a result of diurnal cycling.

### Maximum long term base material temperature

Long-term elevated base material temperatures are roughly constant over significant periods of time.

### Curing time

Temperature of the base material	Minimum curing time
$T_{BM}$	$t_{cure}$
-10 °C to -6 °C	5 hours
-5 °C to -1 °C	3 hours
0 °C to 4 °C	40 min
5 °C to 9 °C	20 min
10 °C to 19 °C	10 min
20 °C to 40 °C	5 min

**Setting details for HAS-U**

Anchor size		M8	M10	M12	M16	M20	M24	M27	M30
Foil capsule HVU2	$h_{ef1}$ [mm]	8x80	10x90	12x110	16x125	20x170	24x210	27x240	30x270
	$h_{ef2}$ [mm]	-	10x135	12x165	16x190	-	-	-	-
Diameter of element	$d_1=d_{nom}$ [mm]	8	10	12	16	20	24	27	30
Nominal diameter of drill bit	[mm]	10	12	14	18	22	28	30	35
Effective embedment depth (= drill hole depth)	$h_{ef1}=h_{0,1}$ [mm]	80	90	110	125	170	210	240	270
	$h_{ef2}=h_{0,2}$ [mm]	-	135	165	190	-	-	-	-
Maximum diameter of clearance hole in the fixture	$d_f$ [mm]	9	12	14	18	22	26	30	33
Minimum thickness of concrete member	$h_{min1}$ [mm]	110	120	140	160	220	270	300	340
	$h_{min2}$ [mm]	-	165	195	230	-	-	-	-
Maximum torque moment <sup>a)</sup>	$T_{max}$ [Nm]	10	20	40	80	150	200	270	300
Minimum spacing	$s_{min}$ [mm]	40	50	60	75	90	115	120	140
Minimum edge distance	$c_{min}$ [mm]	40	45	45	50	55	60	75	80
Critical spacing for splitting failure	$s_{cr,sp}$	$2 C_{cr,sp}$							
Critical edge distance for splitting failure <sup>b)</sup>	$c_{cr,sp}$ [mm]	$1,0 \cdot h_{ef}$ for $h / h_{ef} \geq 2,0$							
		$4,6 h_{ef} - 1,8 h$ for $2,0 > h/h_{ef} > 1,3$							
		$2,26 h_{ef}$ for $h / h_{ef} \leq 1,3$							
Critical spacing for concrete cone failure	$s_{cr,N}$ [mm]	$2 C_{cr,N}$							
Critical edge distance for concrete cone failure <sup>c)</sup>	$c_{cr,N}$ [mm]	$1,5 h_{ef}$							

For spacing (edge distance) smaller than critical spacing (critical edge distance) the design loads have to be reduced.

- a) Maximum recommended torque moment to avoid splitting failure during installation with minimum spacing and/or edge distance  
 b)  $h$ : base material thickness ( $h \geq h_{min}$ )  
 c) The critical edge distance for concrete cone failure depends on the embedment depth  $h_{ef}$  and the design bond resistance. The simplified formula given in this table is on the safe side.

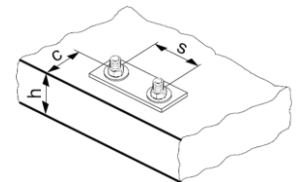
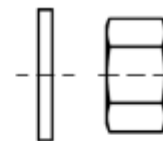
**HAS-U-...: M8 to M30**

washer nut

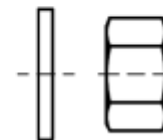
**HAS-U-...P: M8 to M24**

washer nut

**Setting details for HIS-N**

Anchor size		M8	M10	M12	M16	M20
Foil capsule HVU2		10x90	12x110	16x125	20x170	24x210
Diameter of element	$d_1=d_{nom}$ [mm]	12,5	16,5	20,5	25,4	27,8
Nominal diameter of drill bit	$d_0$ [mm]	14	18	22	28	32
Effective embedment depth (= drill hole depth)	$h_{ef}=h_0$ [mm]	90	110	125	170	205
Maximum diameter of clearance hole in the fixture	$d_f$ [mm]	9	12	14	18	22
Minimum thickness of concrete member	$h_{min}$ [mm]	120	150	170	230	270
Maximum torque moment <sup>a)</sup>	$T_{max}$ [Nm]	10	20	40	80	150
Thread engagement length min-	$h_s$ [mm]	8-20	10-25	12-30	16-40	20-50
Minimum spacing	$s_{min}$ [mm]	60	75	90	115	130
Minimum edge distance	$c_{min}$ [mm]	40	45	55	65	90
Critical spacing for splitting failure	$s_{cr,sp}$	$2 c_{cr,sp}$				
Critical edge distance for splitting failure <sup>b)</sup>	$c_{cr,sp}$ [mm]	$1,0 \cdot h_{ef}$ for $h / h_{ef} \geq 2,0$				
		$4,6 h_{ef} - 1,8 h$ for $2,0 > h / h_{ef} > 1,3$				
		$2,26 h_{ef}$ for $h / h_{ef} \leq 1,3$				
Critical spacing for concrete cone failure	$s_{cr,N}$ [mm]	$2 c_{cr,N}$				
Critical edge distance for concrete cone failure <sup>c)</sup>	$c_{cr,N}$ [mm]	$1,5 h_{ef}$				

For spacing (edge distance) smaller than critical spacing (critical edge distance) the design loads have to be reduced.

- a) Maximum recommended torque moment to avoid splitting failure during installation with minimum spacing and/or edge distance
- b)  $h$ : base material thickness ( $h \geq h_{min}$ )
- c) The critical edge distance for concrete cone failure depends on the embedment depth  $h_{ef}$  and the design bond resistance. The simplified formula given in this table is on the safe side.

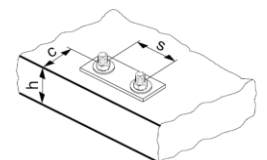
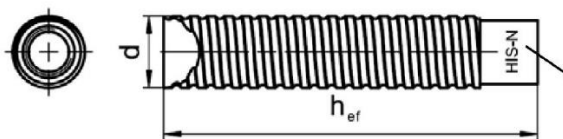
**Internally threaded sleeve HIS-(R)N...**

**Marking:**  
 Identifying mark - HILTI and  
 embossing "HIS-N" (for zinc coated steel)  
 embossing "HIS-RN" (for stainless steel)



**Drilling and cleaning parameters**

HAS-U	HIS-N	Drilling			Cleaning
		Hammer drilling	Hollow Drill Bit	Diamond coring	Brush HIT-RB
		d <sub>0</sub> [mm]			size [mm]
M8	-	10	-	-	-
M10	-	12	12	12	12
M12	M8	14	14	14	14
M16	M10	18	18	18	18
M20	M12	22	22	22	22
M24	M16	28	28	28	28
M27	-	30	-	30	30
-	M20	32	32	32	32
M30	-	35	35	35	35

**Setting tools parameters**

HAS	HIS-N	TE (A)	SID 4 A-22	SIW 22T-A	SF(H)	RPM
M8	-	1...7	+	+	2, 6, 8, 10, 14, 22	450...1300
M10	M8	1...7	+	+	6, 8, 10, 14, 22	450...1300
M10	-	1...40	-	-	6, 8, 10, 14, 22	450...1300
M12	M10	1...40	+	+	6, 8, 10, 14, 22	450...1300
M12	-	1...40	-	-	6, 8, 10, 14, 22	450...1300
M16	M12	1...40	+	-	6, 8, 10, 14, 22	450...1300
M16	-	50...80				
M20	-	50...60	-	-	-	-
-	M16	40...80	-	-	-	-
M24	-	50...80	-	-	-	-
-	M20	40...80	-	-	-	-
M27	-	60...80	-	-	-	-
M30	-	60...80	-	-	-	-

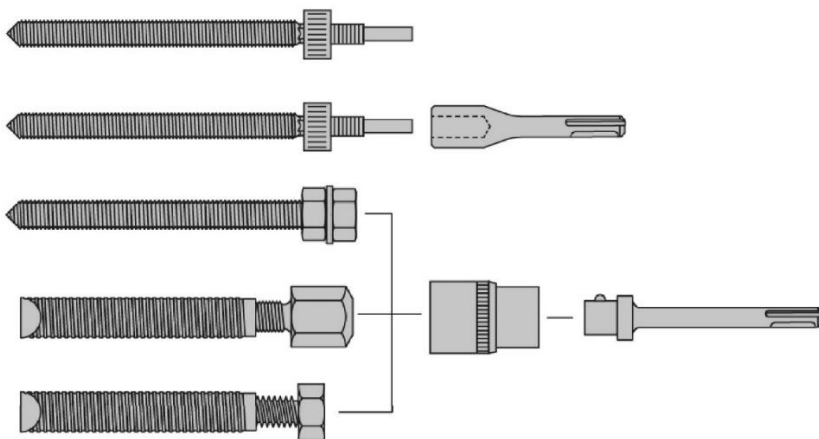

Setting tool		Article number	TE (A) 1...40	TE 50...80	SF (H)	SID 4-A22	HIS-S 
-		-	-	-	+	-	-
TE-C HVU2		#2181356	+	-	-	-	-
TE-Y HVU2		#2230162...5	-	+	-	-	-
TE-C 1/2"		#32220	+	-	-	-	+
TE-Y 3/4"		#32221	-	+	-	-	+
SI-SA 1/4"-1/2"		#2077174	-	-	+	+	+
SI-SA 7/16"		#2134075	-	-	+	-	+

## Setting instructions

\*For detailed information on installation see instruction for use given with the package of the product.



### Safety regulations.

Review the Material Safety Data Sheet (MSDS) before use for proper and safe handling! Wear well-fitting protective goggles and protective gloves when working with Hilti HVU2.

## Hole drilling

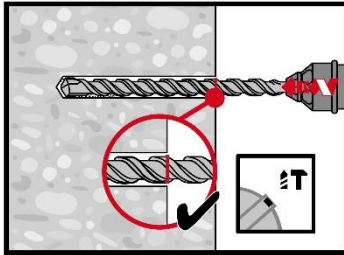

### Hammer drilled hole

For dry or wet concrete and installation in flooded holes (no sea water).

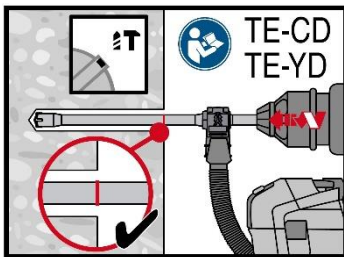

### Hammer drilled hole with Hollow drill bit

For dry and wet concrete, only.  
No cleaning required.

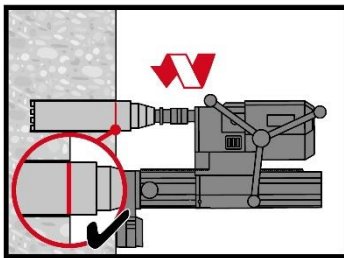

### Diamond Coring

For dry or wet concrete only.

## Hole cleaning

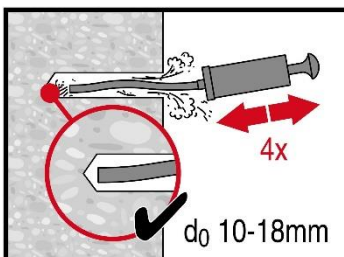

### Manual cleaning for hammer drilled hole

for drill hole diameters  $d_0 \leq 18$  mm and drill hole depths  $h_0 \leq 10 \cdot d_0$ .

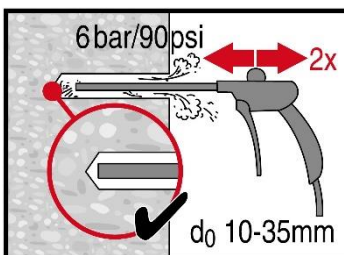

### Compressed air cleaning (CAC) for hammer drilled hole

for all drill hole diameters  $d_0$  and all drill hole depths  $h_0$ .

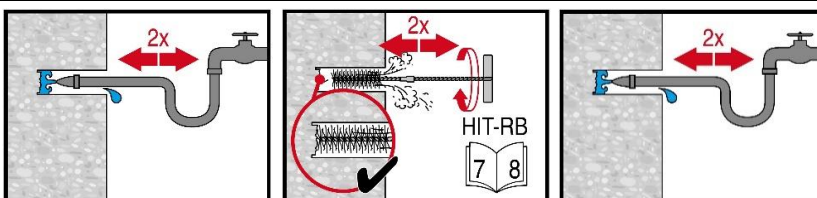

### Hammer drilled flooded holes and diamond cored holes:

for all drill hole diameters  $d_0$  and all drill hole depths  $h_0$ .

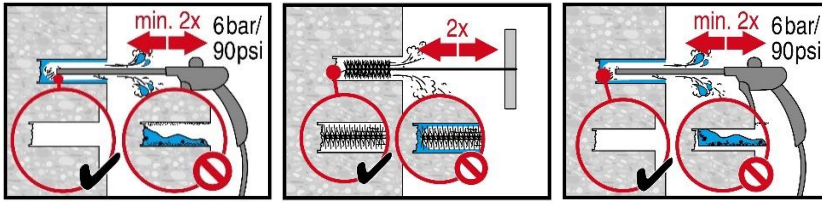

**Setting the element**

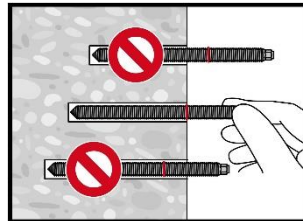
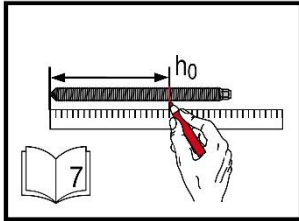

**Check setting depth.**

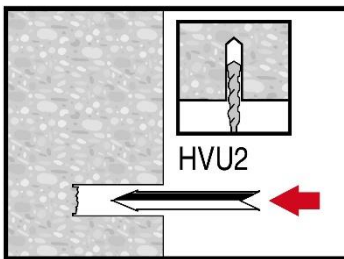

**Insert the foil capsule** with the peak ahead to the back of the hole.

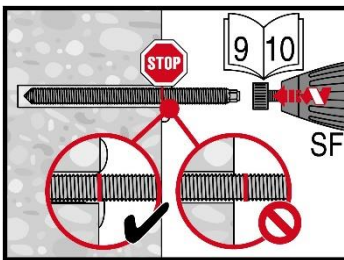

**Drive the anchor rod** with the plugged tool into the hole.

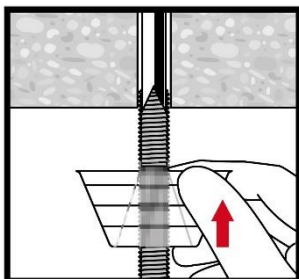
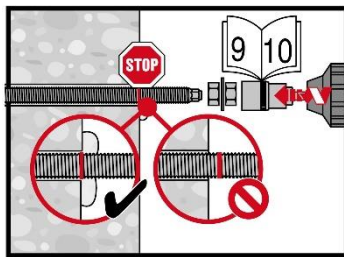

**Overhead installation**  
For HVU2 M8 to M24.

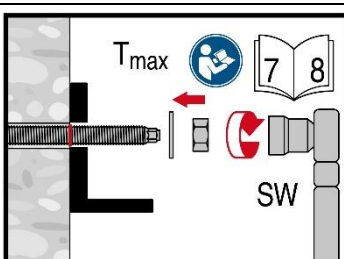

**Loading the anchor** after required curing time  $t_{cure}$ .

## 2.2 Multimaterial

### 2.2.1 HIT-HY 170

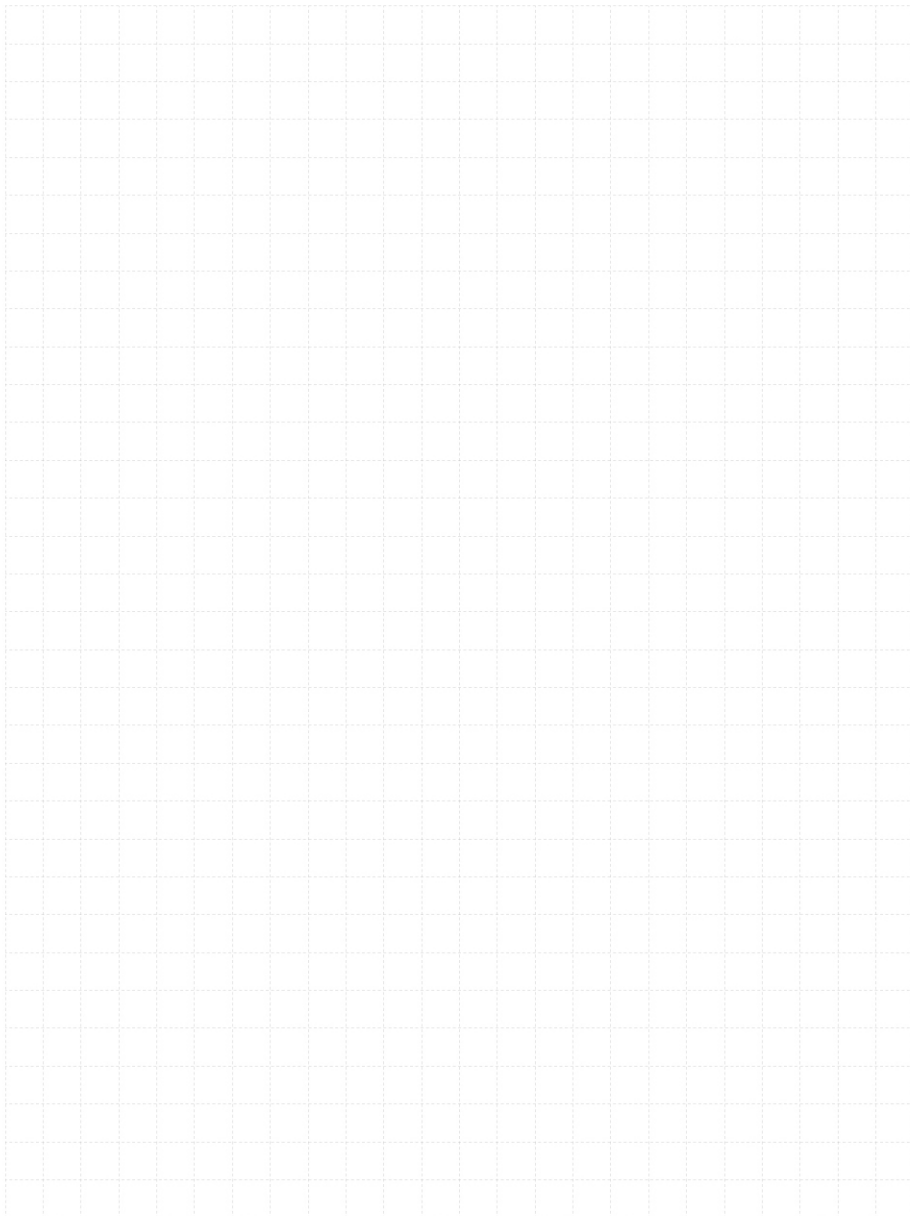

# HIT-HY 170 injection mortar

## Anchor design (EN 1992-4) / Rods and Sleeves / Concrete

### Injection mortar system



Hilti HIT-HY 170

500 ml foil pack  
(also available as  
330 ml foil pack)



Anchor rod:  
HAS-U  
HAS-U HDG  
HAS-U A4  
HAS-U HCR  
(M8-M24)



Internally  
threaded sleeve:  
HIS-N  
HIS-RN  
(M8-M16)

### Benefits

- Suitable for non-cracked and cracked <sup>a)</sup> concrete C 20/25 to C 50/60.
- Suitable for dry and water saturated concrete.
- Small edge distance and anchor spacing possible.
- High corrosion / corrosion resistant.
- In service temperature range up to 80°C short term / 50°C long term.

a) Applications only with HAS-U anchor rods.

### Base material



Concrete  
(non-cracked)



Concrete  
(cracked) <sup>a)</sup>

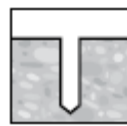

Dry concrete

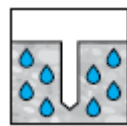

Wet  
concrete

### Load conditions



Static/  
quasi-static



Seismic,  
ETA-C2

### Installation conditions

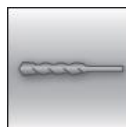

Hammer  
drilled holes

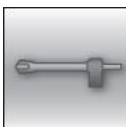

Hollow drill-  
bit drilling



Small edge  
embedment  
depth

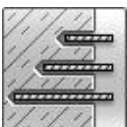

Variable  
embedment  
depth

### Other information



European  
Technical  
Assessment



CE  
conformity

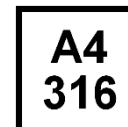

Corrosion  
resistance



High  
corrosion  
resistance <sup>a)</sup>

a) Applications only with HAS-U-HCR anchor rods.

### Approvals / certificates

Description	Authority / Laboratory	No. / date of issue
European technical Approval <sup>a)</sup>	DIBt, Berlin, Germany	ETA-19/0465 / 2019-08-28
European technical Approval <sup>b)</sup>	DIBt, Berlin, Germany	ETA-14/0457 / 2017-12-14

a) All data given in this section according to ETA-19/0465, issue 2019-08-28.

b) All data given in this section according to ETA-14/0457, issue 2017-12-14.

**Static and quasi-static resistance (for a single anchor)**
**All data in this section applies to:**

- Correct setting (See setting instruction)
- No edge distance and spacing influence
- Steel failure
- Base material thickness as specified in the table
- Embedment depth, as specified in the table
- Anchor material, as specified in the tables
- Concrete C 20/25,  $f_{ck,cube} = 25 \text{ N/mm}^2$
- In-service temperature range I:  
(max. long term temperature +24 °C and max. short term temperature +40 °C)

**Embedment depth and base material thickness <sup>a)</sup>**

Anchor size			M8	M10	M12	M16	M20	M24
<b>HAS-U</b>								
Embedment depth	$h_{ef}$	[mm]	80	90	110	125	170	210
Base material thickness	$h$	[mm]	110	120	140	160	220	270
<b>HIS-N</b>								
Embedment depth	$h_{ef}$	[mm]	90	110	125	170	-	-
Base material thickness	$h$	[mm]	120	150	170	230	-	-

a) The allowed range of embedment depth is shown in the setting details.

**For hammer drilled holes, hammer drilled holes with Hilti hollow drill bit:**
**Characteristic resistance**

Anchor size			M8	M10	M12	M16	M20	M24	
<b>Non-cracked concrete</b>									
Tension	HAS-U 5.8	$N_{Rk}$	[kN]	18,3	28,3	41,5	62,8	106,8	149,7
	HAS-U 8.8			20,1	28,3	41,5	62,8	106,8	149,7
	HAS-U A4			20,1	28,3	41,5	62,8	106,8	149,7
	HAS-U HCR			20,1	28,3	41,5	62,8	106,8	149,7
	HIS-N 8.8			25,0	46,0	67,0	121,9	-	-
Shear	HAS-U 5.8	$V_{Rk}$	[kN]	9,2	14,5	21,1	39,3	6130	88,0
	HAS-U 8.8			14,6	23,2	33,7	62,8	98,0	141,2
	HAS-U A4			12,8	20,3	29,5	55,0	85,8	123,6
	HAS-U HCR			14,6	23,2	33,7	62,8	98,0	123,6
	HIS-N 8.8			13,0	23,0	34,0	63,0	-	-
<b>Cracked concrete</b>									
Tension	HAS-U 5.8	$N_{Rk}$	[kN]	-	15,6	22,8	34,6	-	-
	HAS-U 8.8			-	15,6	22,8	34,6	-	-
	HAS-U A4			-	15,6	22,8	34,6	-	-
	HAS-U HCR			-	15,6	22,8	34,6	-	-
Shear	HAS-U 5.8	$V_{Rk}$	[kN]	-	14,5	21,1	39,3	-	-
	HAS-U 8.8			-	23,2	33,7	62,8	-	-
	HAS-U A4			-	20,3	29,5	55,0	-	-
	HAS-U HCR			-	23,2	33,7	62,8	-	-

**Design resistance**

Anchor size		M8	M10	M12	M16	M20	M24		
<b>Non-cracked concrete</b>									
Tension	HAS-U 5.8	N <sub>Rd</sub>	[kN]	12,2	18,8	27,6	41,9	71,2	99,8
	HAS-U 8.8			13,4	18,8	27,6	41,9	71,2	99,8
	HAS-U A4			13,4	18,8	27,6	41,9	71,2	99,8
	HAS-U HCR			13,4	18,8	27,6	41,9	71,2	99,8
	HIS-N 8.8			16,7	30,7	44,7	72,7	-	-
Shear	HAS-U 5.8	V <sub>Rd</sub>	[kN]	7,3	11,6	16,9	31,4	49,0	70,6
	HAS-U 8.8			11,7	18,6	27,0	50,2	78,4	113,0
	HAS-U A4			8,2	13,0	18,9	35,2	55,0	79,2
	HAS-U HCR			11,7	18,6	27,0	50,2	78,4	70,6
	HIS-N 8.8			10,4	18,4	27,2	50,4	-	-
<b>Cracked concrete</b>									
Tension	HAS-U 5.8	N <sub>Rd</sub>	[kN]	-	10,4	15,2	23,0	-	-
	HAS-U 8.8			-	10,4	15,2	23,0	-	-
	HAS-U A4			-	10,4	15,2	23,0	-	-
	HAS-U HCR			-	10,4	15,2	23,0	-	-
Shear	HAS-U 5.8	V <sub>Rd</sub>	[kN]	-	11,6	16,9	31,4	-	-
	HAS-U 8.8			-	18,6	27,0	46,1	-	-
	HAS-U A4			-	13,0	18,9	35,2	-	-
	HAS-U HCR			-	18,6	27,0	46,1	-	-

**Recommended loads <sup>a)</sup>**

Anchor size		M8	M10	M12	M16	M20	M24		
<b>Non-cracked concrete</b>									
Tension	HAS-U 5.8	N <sub>Rec</sub>	[kN]	8,7	13,5	19,7	29,9	50,9	71,3
	HAS-U 8.8			9,6	13,5	19,7	29,9	50,9	71,3
	HAS-U A4			9,6	13,5	19,7	29,9	50,9	71,3
	HAS-U HCR			9,6	13,5	19,7	29,9	50,9	71,3
	HIS-N 8.8			11,9	21,9	31,9	51,9	-	-
Shear	HAS-U 5.8	V <sub>Rec</sub>	[kN]	5,2	8,3	12,0	22,4	35,0	50,4
	HAS-U 8.8			8,4	13,3	19,3	35,9	56,0	80,7
	HAS-U A4			5,9	9,3	13,5	25,2	39,3	56,6
	HAS-U HCR			8,4	13,3	19,3	35,9	56,0	50,4
	HIS-N 8.8			7,4	13,1	19,4	36,0	-	-
<b>Cracked concrete</b>									
Tension	HAS-U 5.8	N <sub>Rec</sub>	[kN]	-	7,4	10,9	16,5	-	-
	HAS-U 8.8			-	7,4	10,9	16,5	-	-
	HAS-U A4			-	7,4	10,9	16,5	-	-
	HAS-U HCR			-	7,4	10,9	16,5	-	-
Shear	HAS-U 5.8	V <sub>Rec</sub>	[kN]	-	8,3	12,0	22,4	-	-
	HAS-U 8.8			-	13,3	19,3	32,9	-	-
	HAS-U A4			-	9,3	13,5	25,2	-	-
	HAS-U HCR			-	13,3	19,3	32,9	-	-

a) With overall partial safety factor for action  $\gamma=1,4$ . The partial safety factors for action depend on the type of loading and shall be taken from national regulations.



## Seismic resistance

### All data in this section applies to:

- Hammer drilled holes and hammer drilled holes with hollow drill bit
- Correct setting (See setting instructions)
- No edge distance and spacing influence
- Steel failure
- Minimum base material thickness
- Concrete C20/25,  $f_{ck,cube} = 25 \text{ N/mm}^2$
- $\alpha_{gap} = 1,0$  (using Hilti seismic filling set) or  $\alpha_{gap} = 0,5$  (without using Hilti seismic filling set) accordingly
- in-service temperature range I:  $-40 \text{ °C}$  to  $+40 \text{ °C}$   
(max. long term temperature  $+24 \text{ °C}$  and max. short term temperature  $+40 \text{ °C}$ )

### Embedment depth and base material thickness for seismic C2

Anchor size		M8	M10	M12	M16	M20	M24
<b>HAS-U</b>							
Embedment depth	$h_{ef}$ [mm]	80	90	110	125	170	210
Base material thickness	$h$ [mm]	110	120	140	160	220	270

### For hammer drilled holes and hollow drill bit:

#### Characteristic resistance in case of seismic performance category C2

Anchor size		M8	M10	M12	M16	M20	M24
Tensile	HAS-U 8.8, AM 8.8	-	-	8,3	11,9	-	-
	HAS-U 8.8 HDG, AM 8.8 HDG			8,3	11,9		
<b>with Hilti filling set</b>							
Shear	HAS-U 8.8, AM 8.8	-	-	28,0	46,0	-	-
	HAS-U 8.8 HDG, AM 8.8 HDG			18,0	30,0		
<b>without Hilti filling set</b>							
Shear	HAS-U 8.8, AM 8.8	-	-	24,0	40,0	-	-
	HAS-U 8.8 HDG, AM 8.8 HDG			9,0	15,0		

#### Design resistance in case of seismic performance category C2

Anchor size		M8	M10	M12	M16	M20	M24
Tensile	HAS-U 8.8, AM 8.8	-	-	5,5	8,0	-	-
	HAS-U 8.8 HDG, AM 8.8 HDG			5,5	8,0		
<b>with Hilti filling set</b>							
Shear	HAS-U 8.8, AM 8.8	-	-	22,4	36,8	-	-
	HAS-U 8.8 HDG, AM 8.8 HDG			14,4	24,0		
<b>without Hilti filling set</b>							
Shear	HAS-U 8.8, AM 8.8	-	-	19,2	32,0	-	-
	HAS-U 8.8 HDG, AM 8.8 HDG			7,2	12,0		



**Materials**
**Materials properties for HAS-U**

Anchor size				M8	M10	M12	M16	M20	M24
Nominal tensile strength	HAS-U 5.8	$f_{uk}$	[N/mm <sup>2</sup> ]	500	500	500	500	500	500
	HAS-U 8.8			800	800	800	800	800	800
	HAS-U A4			700	700	700	700	700	700
	HAS-U HCR			800	800	800	800	800	700
Yield strength	HAS-U 5.8	$f_{yk}$	[N/mm <sup>2</sup> ]	400	400	400	400	400	400
	HAS-U 8.8			640	640	640	640	640	640
	HAS-U A4			450	450	450	450	450	450
	HAS-U HCR			640	640	640	640	640	400
Stressed cross-section	HAS-U	$A_s$	[mm <sup>2</sup> ]	36,6	58,0	84,3	157	245	353
Moment of resistance	HAS-U	$W$	[mm <sup>3</sup> ]	31,2	62,3	109	277	541	935

**Mechanical properties for HIS-N**

Anchor size				M8	M10	M12	M16
Nominal tensile strength	HIS-N	$f_{uk}$	[N/mm <sup>2</sup> ]	490	490	490	490
	Screw 8.8			800	800	800	800
	HIS-RN			700	700	700	700
	Screw A4-70			700	700	700	700
Yield strength	HIS-N	$f_{yk}$	[N/mm <sup>2</sup> ]	390	390	390	390
	Screw 8.8			640	640	640	640
	HIS-RN			350	350	350	350
	Screw A4-70			450	450	450	450
Stressed cross-section	HIS-(R)N	$A_s$	[mm <sup>2</sup> ]	51,5	108,0	169,1	256,1
	Screw			36,6	58	84,3	157
Moment of resistance	HIS-(R)N	$W$	[mm <sup>3</sup> ]	145	430	840	1595
	Screw			31,2	62,3	109	277

**Material quality for HAS-U**

Part	Material
<b>Zinc coated steel</b>	
Threaded rod, HAS-U 5.8 (HDG)	Strength class 5.8; Elongation at fracture A5 > 8% ductile Electroplated zinc coated $\geq 5\mu\text{m}$ ; (HDG) hot dip galvanized $\geq 45\mu\text{m}$
Threaded rod, HAS-U 8.8 (HDG)	Strength class 8.8; Elongation at fracture A5 > 12% ductile Electroplated zinc coated $\geq 5\mu\text{m}$ ; (HDG) hot dip galvanized $\geq 45\mu\text{m}$
Hilti Meter rod, AM 8.8 (HDG)	Strength class 8.8; Elongation at fracture A5 > 12% ductile Electroplated zinc coated $\geq 5\mu\text{m}$ (HDG) hot dip galvanized $\geq 45\mu\text{m}$
Washer	Electroplated zinc coated $\geq 5\mu\text{m}$ , hot dip galvanized $\geq 45\mu\text{m}$
Nut	Strength class of nut adapted to strength class of threaded rod. Electroplated zinc coated $\geq 5\mu\text{m}$ , hot dip galvanized $\geq 45\mu\text{m}$
Hilti Filling set (F)	Filling washer: Electroplated zinc coated $\geq 5\mu\text{m}$ , (F) hot dip galvanized $\geq 45\mu\text{m}$ Spherical washer: Electroplated zinc coated $\geq 5\mu\text{m}$ , (F) hot dip galvanized $\geq 45\mu\text{m}$ Lock nut: Electroplated zinc coated $\geq 5\mu\text{m}$ , (F) hot dip galvanized $\geq 45\mu\text{m}$
<b>Stainless Steel</b>	
Threaded rod, HAS-U A4	Strength class 70 for $\leq M24$ and strength class 50 for $> M24$ ; Elongation at fracture A5 > 8% ductile Stainless steel 1.4401; 1.4404; 1.4578; 1.4571; 1.4439; 1.4362
Washer	Stainless steel 1.4401, 1.4404, 1.4578, 1.4571, 1.4439, 1.4362 EN 10088-1:2014
Nut	Stainless steel 1.4401, 1.4404, 1.4578, 1.4571, 1.4439, 1.4362 EN 10088-1:2014
<b>High corrosion resistant steel</b>	
Threaded rod, HAS-U HCR	Strength class 80 for $\leq M20$ and class 70 for $> M20$ , Elongation at fracture A5 > 8% ductile High corrosion resistance steel 1.4529; 1.4565;
Washer	High corrosion resistant steel 1.4529, 1.4565 EN 10088-1:2014
Nut	High corrosion resistant steel 1.4529, 1.4565 EN 10088-1:2014

**Material quality for HIS-N**

Part	Material	
HIS-N	Internal threaded sleeve	C-steel 1.0718 / Steel galvanized $\geq 5\mu\text{m}$
	Screw 8.8	Strength class 8.8, A5 > 8 % Ductile / Steel galvanized $\geq 5\mu\text{m}$
HIS-RN	Internal threaded sleeve	Stainless steel 1.4401, 1.4571
	Screw 70	Strength class 70, A5 > 8 % Ductile Stainless steel 1.4401; 1.4404, 1.4578; 1.4571; 1.4439; 1.4362

## Setting information

### Installation temperature range

-5°C to +40°C

### In service temperature range

Hilti HIT-HY 170 injection mortar with anchor rod HIT-V may be applied in the temperature ranges given below. An elevated base material temperature leads to a reduction of the design bond resistance.

Temperature range	Base material temperature	Maximum long term base material temperature	Maximum short term base material temperature
Temperature range I	-40 °C to +40 °C	+24 °C	+40 °C
Temperature range II	-40 °C to +80 °C	+50 °C	+80 °C

### Maximum short term base material temperature

Short-term elevated base material temperatures are those that occur over brief intervals, e.g. as a result of diurnal cycling.

### Maximum long term base material temperature

Long-term elevated base material temperatures are roughly constant over significant periods of time.

### Curing and working time <sup>a)</sup>

Temperature of the base material	Maximum working time	Minimum curing time <sup>a)</sup>
$T_{BM}$	$t_{work}$	$t_{cure}$
$-5\text{ °C} \leq T_{BM} \leq 0\text{ °C}$ <sup>a)</sup>	10 min	12 hours
$0\text{ °C} \leq T_{BM} \leq 5\text{ °C}$ <sup>a)</sup>	10 min	5 hours
$5\text{ °C} \leq T_{BM} \leq 10\text{ °C}$	8 min	2,5 hours
$10\text{ °C} \leq T_{BM} \leq 20\text{ °C}$	5 min	1,5 hours
$20\text{ °C} \leq T_{BM} \leq 30\text{ °C}$	3 min	45 min
$30\text{ °C} \leq T_{BM} \leq 40\text{ °C}$	2 min	30 min

a) The curing time data are valid for dry base material only. In wet base material the curing times must be doubled.

**Setting details for HAS-U**

Anchor size			M8	M10	M12	M16	M20	M24
Nominal diameter of drill bit	$d_0$	[mm]	10	12	14	18	22	28
Diameter of the element	$d$	[mm]	8	10	12	16	20	24
Effective embedment depth (=drill hole depth) <sup>a)</sup>	$h_{ef,min} = h_0$	[mm]	60	60	70	80	90	96
	$h_{ef,max} = h_0$	[mm]	96	120	144	192	240	288
Minimum base material thickness <sup>b)</sup>	$h_{min}$	[mm]	$h_{ef} + 30 \text{ mm} \geq 100 \text{ mm}$			$h_{ef} + 2 d_0$		
Maximum diameter of clearance hole in the fixture	$d_f$	[mm]	9	12	14	18	22	26
Maximum torque moment	$T_{max}$	[Nm]	10	20	40	80	150	200
Minimum spacing	$s_{min}$	[mm]	40	50	60	75	90	115
Minimum edge distance	$c_{min}$	[mm]	40	45	45	50	55	60
Critical spacing for splitting failure	$s_{cr,sp}$	[mm]	$2 C_{cr,sp}$					
Critical edge distance for splitting failure <sup>c)</sup>	$C_{cr,sp}$	[mm]	$1,0 \cdot h_{ef}$ for $h / h_{ef} \geq 2,00$					
			$4,6 h_{ef} - 1,8 h$ for $2,00 > h / h_{ef} > 1,3$					
			$2,26 h_{ef}$ for $h / h_{ef} \leq 1,3$					
Critical spacing for concrete cone failure	$s_{cr,N}$	[mm]	$2 C_{cr,sp}$					
Critical edge distance for concrete cone failure <sup>d)</sup>	$C_{cr,N}$	[mm]	$1,5 h_{ef}$					

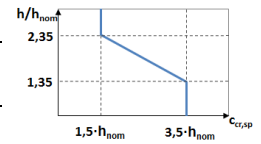

For spacing (edge distance) smaller than critical spacing (critical edge distance) the design loads have to be reduced.  $h_{ef,min} \leq h_{ef} \leq h_{ef,max}$  ( $h_{ef}$ : embedment depth)

- a) Maximum recommended torque moment to avoid splitting failure during instalation with minimum spacing and edge distance
- b)  $h$ : base material thickness ( $h \geq h_{min}$ )
- c) The critical edge distance for concrete cone failure depends on the embedment depth  $h_{ef}$  and the design bond resistance. The simplified formula given in this table is on the save side.

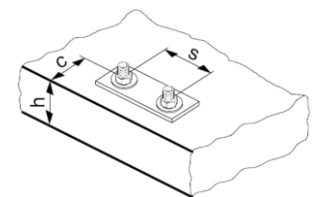
**HAS-U...**

**Marking:**

Steel grade number and length identification letter: e.g. 8L

**AM 8.8**

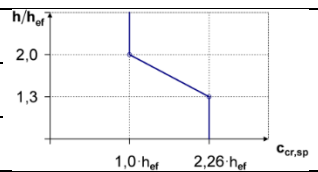

**Setting details for HIS-N**

Anchor size			M8	M10	M12	M16
Nominal diameter of drill bit	$d_0$	[mm]	14	18	22	28
Diameter of element	$d$	[mm]	12,5	16,5	20,5	25,4
Effective embedment depth (=drill hole depth) <sup>a)</sup>	$h_{ef}$	[mm]	90	110	125	170
Minimum base material thickness	$h_{min}$	[mm]	120	150	170	230
Maximum diameter of clearance hole in the fixture	$d_f$	[mm]	9	12	14	18
Thread engagement length min-max	$h_s$	[mm]	8-20	10-25	12-30	16-40
Minimum spacing	$s_{min}$	[mm]	60	75	90	115
Minimum edge distance	$c_{min}$	[mm]	40	45	55	65
Critical spacing for splitting failure	$c_{cr,sp}$	[mm]	$2 c_{cr,sp}$			
Critical edge distance for splitting failure <sup>a)</sup>	$c_{cr,sp}$	[mm]	$1,0 \cdot h_{ef}$		for $h / h_{ef} \geq 2,0$	
			$4,6 h_{ef} - 1,8 h$		for $2,0 > h / h_{ef} > 1,3$	
			$2,26 h_{ef}$		for $h / h_{ef} \leq 1,3$	
Critical spacing for concrete cone failure	$c_{cr,N}$	[mm]	$2 c_{cr,N}$			
Critical edge distance for concrete cone failure <sup>b)</sup>	$c_{cr,N}$	[mm]	$1,5 h_{ef}$			
Maximum torque moment <sup>c)</sup>	$T_{max}$	[Nm]	10	20	40	80



For spacing (edge distance) smaller than critical spacing (critical edge distance) the design loads have to be reduced.

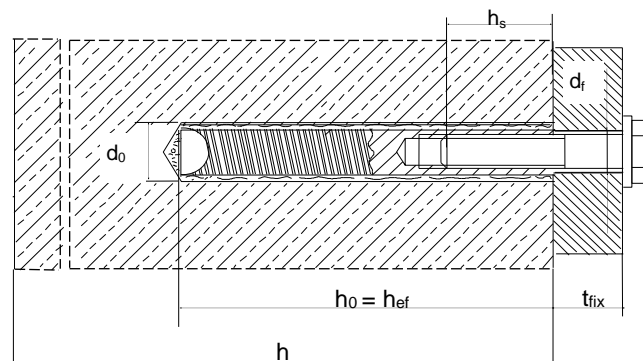





- $h$ : base material thickness ( $h \geq h_{min}$ ),  $h_{ef}$ : embedment depth
- The critical edge distance for concrete cone failure depends on the embedment depth  $h_{ef}$  and the design bond resistance. The simplified formula given in this table is on the safe side.
- Maximum recommended torque moment to avoid splitting failure during installation with minimum spacing and/or edge distance.



**Installation equipment**

Anchor size		M8	M10	M12	M16	M20	M24
Rotary hammer	HAS-U	TE 2 (-A) – TE 30 (-A)				TE 40 - TE 80	
	HIS-N	TE 2 (-A) – TE 30 (-A)		TE 40 - TE 80		-	
Other tools		blow out pump ( $h_{ef} \leq 10 \cdot d$ ), compressed air gun, set of cleaning brushes, dispenser					

**Drilling and cleaning parameters**

HAS-U	HIS-N	Drill bit diameters $d_0$ [mm]		Installation size [mm]	
		Hammer drill (HD)	Hollow Drill Bit (HDD)	Brush HIT-RB	Piston plug HIT-SZ
					
<b>M8</b>	-	10	-	10	-
<b>M10</b>	-	12	-	12	12
<b>M12</b>	<b>M8</b>	14	14	14	14
<b>M16</b>	<b>M10</b>	18	18	18	18
<b>M20</b>	<b>M12</b>	22	22	22	22
<b>M24</b>	<b>M16</b>	28	28	28	28

## Setting instructions

\*For detailed information on installation see instruction for use given with the package of the product



### Safety regulations.

Review the Material Safety Data Sheet (MSDS) before use for proper and safe handling! Wear well-fitting protective goggles and protective gloves when working with Hilti HIT-HY 170.

## Drilling

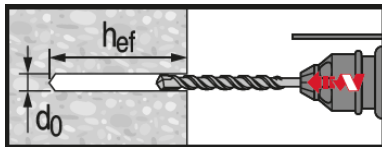

### Hammer drilled hole

For dry and wet concrete.

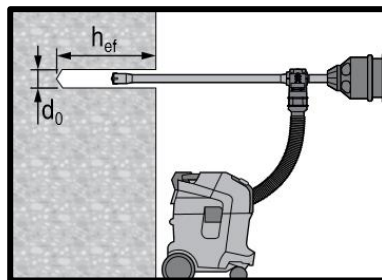

### Hammer drilled hole with Hollow Drilled Bit (HDB)

No cleaning required.

## Cleaning

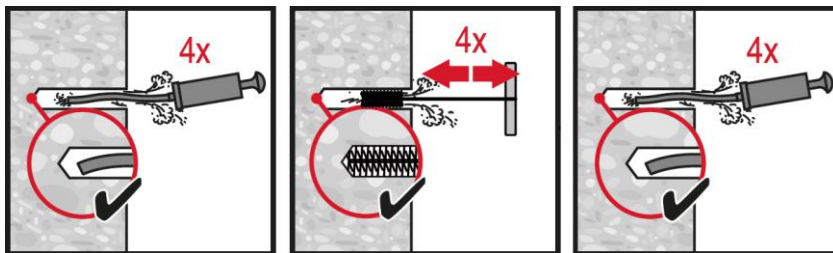

### Manual cleaning (MC)

**Non-cracked concrete only**  
for drill diameters  $d_0 \leq 18$  mm and drill hole depth  $h_0 \leq 10 \cdot d_0$ .

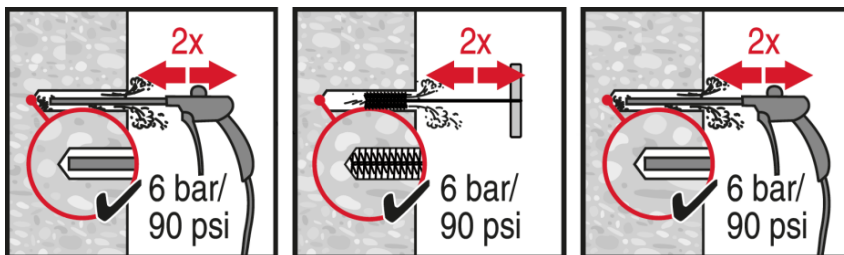

### Compressed air cleaning (CAC)

for all drill hole diameters  $d_0$  and drill hole depths  $h_0$ .

## Injection

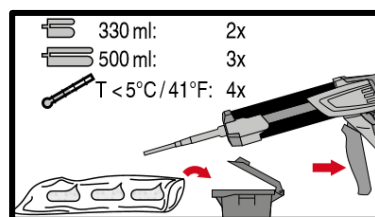
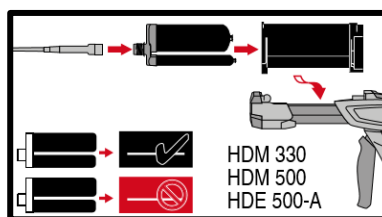

### Injection system preparation.

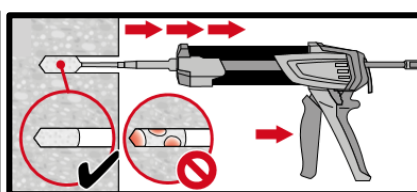
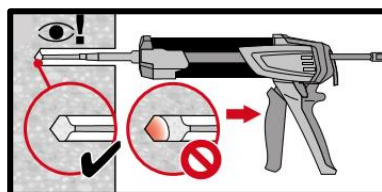

### Injection method for drill hole

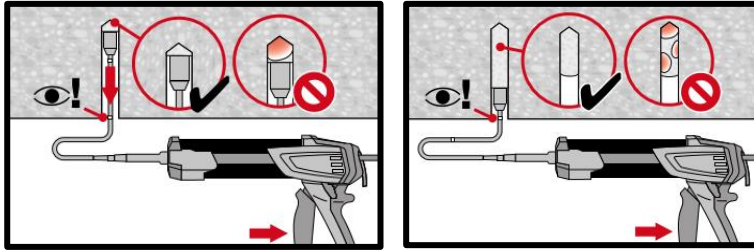

**Injection** method for overhead application and/or installation with embedment depth  $h_{ef} > 250$  mm.

### Setting the element

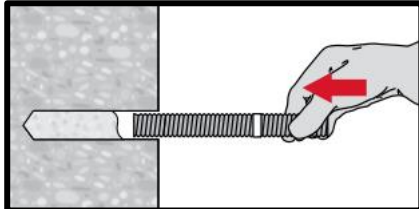

**Setting element**, observe working time " $t_{work}$ ".

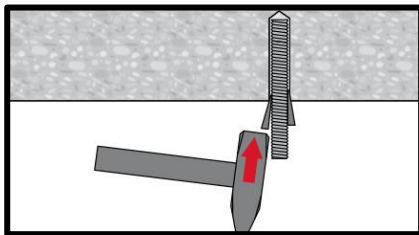

**Setting element** for overhead applications

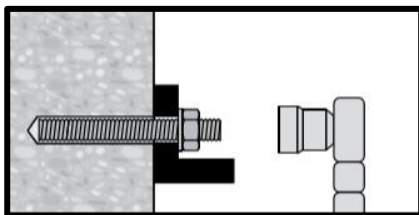

**Loading the anchor** after required curing time  $t_{cure}$



# HIT-HY 170 injection mortar

Anchor design (EOTA TR 054) / Rods and Sleeves / Masonry

## Injection mortar system



Hilti HIT-HY 170

500 ml foil pack  
(also available as  
330 ml foil pack)



Anchor rod:  
HAS-U  
HAS-U HDG  
HAS-U A4  
HAS-U HCR  
(M8-M12)



Internally  
threaded sleeve:  
HIT-IC  
(M8-M12)

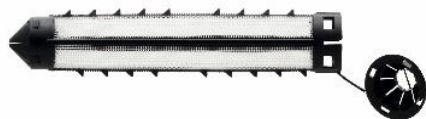

HIT-SC  
sieve sleeve  
(16-22)

## Benefits

- Chemical injection fastening for the most common types of base materials:
- Hollow and solid clay bricks, calcium silicate bricks, normal and light weight concrete blocks
- Two-component hybrid mortar
- Versatile and convenient handling with HDE dispenser
- Mortar filling control with HIT-SC sleeves

## Base material

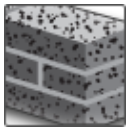

Solid brick



Hollow brick

## Load conditions

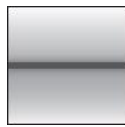

Static/  
quasi-static

## Installation conditions

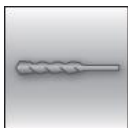

Hammer  
drilled holes

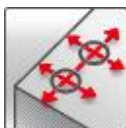

Small edge  
embedment  
depth

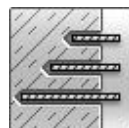

Variable  
embedment  
depth

## Other information



European  
Technical  
Assessment



CE  
conformity

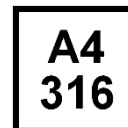

Corrosion  
resistance



High  
corrosion  
resistance



PROFIS  
Engineering  
design  
Software

## Approvals / certificates

Description	Authority / Laboratory	No. / date of issue
European technical Approval <sup>a)</sup>	DIBt, Berlin, Germany	ETA-15/0197 / 2015-12-09
European technical Approval <sup>a)</sup>	DIBt, Berlin, Germany	ETA-19/0161 / 2019-08-28

c) All data given in this section according to ETA-15/0197, issue 2015-12-09 and ETA-19/0161, issue 2019-08-28

## Brick types and properties

### Instruction to this technical data

- Identify/choose your brick (or brick type) and its geometrical/physical properties on the following tables. Information about edge and spacing criteria for every brick is available on page 4.
- The pages referred on the last column of the table below contain the design resistance loads for pull-out failure of the anchor, brick breakout failure and local brick failure for each respective brick. Notice that the data displayed on these tables is only valid for single anchors with distance to edge equal to or greater than  $c_{cr}$  – for other cases not covered, use PROFIS Engineering software, consult ETA-15/0197 or contact Hilti Engineering Team.
- The resistance loads provided by this technical data manual are valid only for exact same masonry unit (hollow bricks) or for units made of the same base material with equal or higher size and compressive strength (solid bricks). For other cases, on-site tests must be performed—please consult page 8.

### Exterior brick dimensions

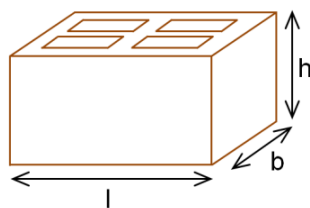

Generic bricks

### Interior dimensions of the majority of the holes

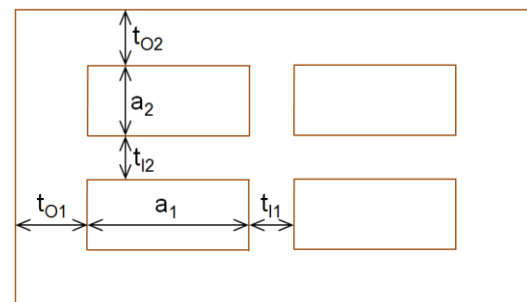

### Brick types and properties

Brick code	Data	Brick name	Image	Size [mm]	$t_0$ [mm]	$t_1$ [mm]	$a$ [mm]	$f_b$ [N/mm <sup>2</sup> ]	$\rho$ [kg/dm <sup>3</sup> ]	Page
<b>Solid Clay</b>										
SC	ETA	Solid clay brick Mz, 2DF		l: $\geq 240$ b: $\geq 115$ h: $\geq 113$	-	-	-	12	2,0	17
<b>Hollow Clay</b>										
HC	ETA	Hollow clay brick Hz, 10DF		l: 300 b: 240 h: 238	$t_{01}:12$ $t_{02}:15$	$t_{11}:11$ $t_{12}:15$	$a_1: 10$ $a_2: 25$	12/20	1,4	17
<b>Solid Calcium Silicate</b>										
SCS	ETA	Solid silica brick KS, 2DF		l: $\geq 240$ b: $\geq 115$ h: $\geq 113$	-	-	-	12/28	2,0	17
<b>Hollow Calcium Silicate</b>										
HCS	ETA	Hollow silica brick KSL, 8DF		l: 248 b: 240 h: 238	$t_{01}:34$ $t_{02}:21$	$t_{11}:12$ $t_{12}:30$	$a_1: 50$ $a_2: 50$	12/20	1,4	17
<b>Hollow lightweight concrete</b>										
HLWC	ETA	Hollow lightweight concrete brick		l: 495 b: 240 h: 238	$t_{01}:45$ $t_{02}:51$	$t_{11}:35$ $t_{12}:36$	$a_1:196$ $a_2: 52$	2/6	0,8	18
<b>Hollow normal weight concrete</b>										
HNWC	ETA	Hollow normal weight concrete brick		l: 500 b: 200 h: 200	$t_{01}:30$ $t_{02}:15$	$t_{11}:15$ $t_{12}:15$	$a_1:133$ $a_2: 75$	4/10	1,0	18

## Anchor installation parameters

### Brick position:

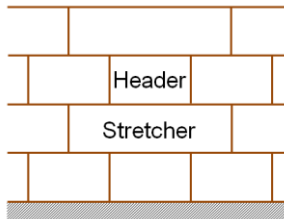

- **Header (H):** The longest dimension of the brick represents the width of the wall
- **Stretcher (S):** The longest dimension of the brick represents the length of the wall

### Spacing and edge distance:

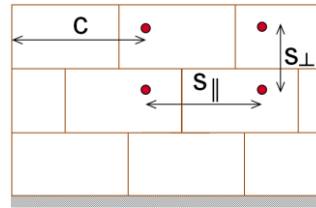

- $c$  - Distance to the edge
- $s_{||}$  - Spacing parallel to the horizontal joint
- $s_{\perp}$  - Spacing perpendicular to the horizontal joint

### Minimum and characteristic spacing and edge distance parameters

- $c_{min}$  - Minimum edge distance
- $c_{cr}$  - Characteristic edge distance
- $s_{min||}$  - Min. spacing distance parallel to the bed joint
- $s_{cr||}$  - Characteristic spacing distance parallel to the bed joint
- $s_{min\perp}$  - Min. spacing distance perpendicular to the bed joint
- $s_{cr\perp}$  - Characteristic spacing distance perpendicular to the bed joint

### Allowed anchor positions:

$$c \geq c_{cr} = c_{min}$$

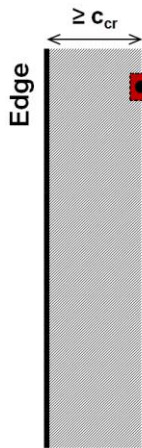

Technical load data in FTM



$$c \geq c_{cr} = c_{min}$$

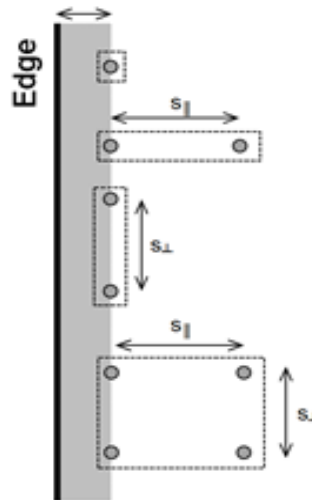

$$s_{||} \geq s_{cr||} = s_{min||}$$

$$s_{\perp} \geq s_{cr\perp} = s_{min\perp}$$

$$s_{||} \geq s_{cr||} = s_{min||}$$

$$s_{\perp} \geq s_{cr\perp} = s_{min\perp}$$

- This FTM includes the load data for single anchors in masonry with a distance to edge equal to or greater than the characteristic edge distance.

**Edge and spacing distances per brick**

Brick code	$c_{min} = c_{cr}$ [mm]	$s_{min  } = s_{cr  }$ [mm]	$s_{min\perp} = s_{cr\perp}$ [mm]
SC	115	240	115
HC	150	300	240
SCS	115	240	115
HCS	125	248	240
HLC	250	240	240
HNC	200	200	200

**Static and quasi-static loading (for a single anchor)**

- Anchorages are designed under the responsibility of an engineer experienced in anchorages and masonry work.
- Verifiable calculation notes and drawings are prepared taking account of the loads to be anchored. The position of the anchor is indicated on the design drawings (e.g. position of the anchor relative to supports, etc.).
- Anchorages under static or quasi-static loading are designed in accordance with: EOTA TR 054

**Basic loading data (for a single anchor)**

The load tables provide the design resistance load for a single loaded anchor.

All data in this section applies to:

- Edge distance  $c \geq c_{cr} = c_{min}$ .
- Correct anchor setting (see instruction for use, setting details)

Anchorage subject to:		Hilti HIT-HY 170 with HIT-V, HAS-U or HIT-IC	
<b>Masonry</b>		<b>in solid bricks</b>	<b>in hollow bricks</b>
<b>Hole drilling</b>		hammer mode	rotary mode
<b>Use category: dry or wet structure</b>		Category <b>d/d</b> - <b>Installation and use</b> in structures subject to <b>dry</b> internal conditions. Category <b>w/d</b> - <b>Installation in dry or wet</b> substrate and <b>use</b> in structures subject to <b>dry</b> , internal conditions. Category <b>w/w</b> - <b>Installation and use</b> in structures subject to <b>dry or wet</b> environmental conditions.	
<b>Installation direction</b>		horizontal	
<b>Use category</b>		b (solid masonry)	c (hollow or perforated masonry)
<b>Temperature in the base material at installation</b>		+5° C to +40° C	-5° C to +40° C (HIT-V, HIT-IC) 0° C to +40° C (HAS-U)
<b>In-service temperature</b>	<b>Temperature range Ta:</b>	-40 °C to +40°C	(max. long term temperature +24°C and max. short term temperature +40 °C)
	<b>Temperature range Tb:</b>	-40 °C to +80°C	(max. long term temperature +50°C and max. short term temperature +80 °C)

## Tension loading

The design tensile resistance is the lower value of

- Steel resistance:  $N_{Rd,s}$
- Pull-out of the anchor:  $N_{Rd,p}$
- Brick breakout failure:  $N_{Rd,b}$
- Pull out of one brick  $N_{Rd,pb}$

## Shear loading

The design shear resistance is the lower value of

- Steel resistance:  $V_{Rd,s}$
- Local brick failure:  $V_{Rd,b}$
- Pushing out of one brick:  $V_{Rd,pb}$

### Design tension and shear resistances – Steel failure for HIT-V and HAS-U

Anchor size			M8	M10	M12
Tension	HIT-V 5.8(F) HAS-U 5.8 (HDG)	$N_{Rd,s}$ [kN]	12,2	19,3	28,1
	HIT-V 8.8(F) HAS-U 8.8 (HDG)		19,5	30,9	44,9
	HIT-V-R HAS-U A4		13,7	21,7	31,6
	HIT-V-HCR HAS-U HCR		19,5	30,9	44,9
Shear	HIT-V 5.8(F) HAS-U 5.8 (HDG)	$V_{Rd,s}$ [kN]	7,4	11,6	16,9
	HIT-V 8.8(F) HAS-U 8.8 (HDG)		11,7	18,6	27,0
	HIT-V-R HAS-U A4		8,2	13,0	18,9
	HIT-V-HCR HAS-U HCR		11,7	18,6	27,0
Bending resistance	HIT-V 5.8(F) HAS-U 5.8 (HDG)	$M^0_{Rd,s}$ [Nm]	15,2	29,6	52,8
	HIT-V 8.8(F) HAS-U 8.8 (HDG)		24,0	48,0	84,0
	HIT-V-R HAS-U A4		16,7	33,4	59,1
	HIT-V-HCR HAS-U HCR		24,0	48,0	84,0

### Design tension and shear resistances – Steel failure for internally threaded sleeves HIT-IC

Anchor size			M8	M10	M12
Tension	HIT-IC	$N_{Rd,s}$ [kN]	3,9	4,8	9,1
Shear	HIT-IC	$V_{Rd,s}$ [kN]	7,4	11,6	16,9
	Screw 8.8		11,7	18,6	27,0
Bending resistance	HIT-IC	$M^0_{Rd,s}$ [Nm]	15,0	29,9	52,4
	Screw 8.8		24,0	47,8	83,8

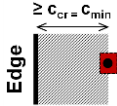

**Design tension and shear resistances – Pull-out failure of the anchor, brick breakout failure and local brick failure at characteristic edge distance ( $c \geq c_{cr} = c_{min}$ ) for single anchor applications**

Load type	Anchor size	$h_{ef}$ [mm]	$f_b$ [N/mm <sup>2</sup> ]	w/w and w/d		d/d		
				Ta	Tb	Ta	Tb	
Loads [kN]								
<b>SC - Solid clay brick</b> Mz, 2DF								
$N_{Rd,p} = N_{Rd,b}$ ( $c_{cr} = c_{min} = 115\text{mm}$ )	HIT-V, HAS-U	M8, M10, M12	80	12	1,2	1,0	1,2	1,0
	HIT-IC	M8			1,2	1,0	1,2	1,0
	HIT-IC	M10, M12			1,6	1,4	1,6	1,4
	HIT-V + HIT-SC	M8, M10, M12			1,6	1,4	1,6	1,4
	HAS-U + HIT-SC	M8, M10, M12			1,6	1,4	1,6	1,4
$V_{Rd,b}$ ( $c_{cr} = c_{min} = 115\text{mm}$ )	HIT-V, HAS-U	M8, M10, M12	80	12	1,4			
	HIT-V + HIT-SC	M8, M10, M12						
	HAS-U + HIT-SC	M8, M10, M12						
	HIT-IC	M8, M10, M12						
	HIT-IC + HIT-SC	M8, M10, M12						
<b>HC - Hollow clay brick</b> Hz, 10DF								
$N_{Rd,p} = N_{Rd,b}$ ( $c_{cr} = c_{min} = 150\text{mm}$ )	HIT-V + HIT-SC	M8, M10, M12	80	12	1,2	1,0	1,2	1,0
	HAS-U + HIT-SC	M8, M10, M12		20	1,4	1,2	1,4	1,2
	HIT-IC + HIT-SC	M8, M10, M12	80	12	0,8			
$V_{Rd,b}$ ( $c_{cr} = c_{min} = 150\text{mm}$ )	HIT-V + HIT-SC	M8, M10, M12		20	1,2			
	HAS-U + HIT-SC	M8, M10, M12						
HIT-IC + HIT-SC	M8, M10, M12							
<b>SCS - Solid silica brick</b> KS, 2DF								
$N_{Rd,p} = N_{Rd,b}$ ( $c_{cr} = c_{min} = 115\text{mm}$ )	HIT-V, HAS-U	M8, M10, M12	80	12	2,2	2,0	2,4	2,0
	HIT-IC	M8, M10, M12		28	3,4	3,0	3,4	3,0
	HIT-V + HIT-SC	M8, M10, M12		12	1,6	1,4	2,2	2,0
	HAS-U + HIT-SC	M8, M10, M12		28	2,4	2,2	3,2	3,0
	HIT-IC + HIT-SC	M8, M10, M12						
$V_{Rd,b}$ ( $c_{cr} = c_{min} = 115\text{mm}$ )	HIT-V, HAS-U	M8, M10, M12	80	12	1,6			
	HAS-U + HIT-SC	M8, M10, M12		28	2,4			
	HIT-V + HIT-SC	M8, M10, M12						
	HIT-IC	M8, M10, M12						
HIT-IC + HIT-SC	M8, M10, M12							
<b>HCS - Hollow silica brick</b> KSL, 8DF								
$N_{Rd,p} = N_{Rd,b}$ ( $c_{cr} = c_{min} = 125\text{mm}$ )	HIT-V + HIT-SC	M8, M10, M12	80	12	1,2	1,0	1,4	1,2
	HAS-U + HIT-SC	M8, M10, M12		20	1,6	1,4	2,0	1,8
$V_{Rd,b}$ ( $c_{cr} = c_{min} = 125\text{mm}$ )	HIT-V + HIT-SC	M8, M10, M12	80	12	3,4			
	HAS-U + HIT-SC	M8, M10, M12		20	4,8			
HIT-IC + HIT-SC	M8, M10, M12							

Load type	Anchor size	$h_{ef}$ [mm]	$f_b$ [N/mm <sup>2</sup> ]	w/w and w/d		d/d	
				Ta	Tb	Ta	Tb
Loads [kN]							
<b>HLWC – Hollow lightweight concrete brick</b> <b>HBL, 16DF</b>							
$N_{Rd,p} = N_{Rd,b}$ ( $C_{cr} = C_{min} = 250$ mm)	HIT-V + HIT-SC	M8, M10, M12	80	2	0,5	0,4	0,6
	HAS-U + HIT-SC	M8, M10, M12		6	0,8	0,6	1,0
	HIT-IC + HIT-SC	M8, M10, M12					
$V_{Rd,b}$ ( $C_{cr} = C_{min} = 250$ mm)	HIT-V + HIT-SC	M8, M10, M12	80	2	1,0		
	HAS-U + HIT-SC	M8, M10, M12		6	1,6		
	HIT-IC + HIT-SC	M8, M10, M12					
<b>HNWC – Hollow normal weight concrete brick</b> <b>Parpaing creux</b>							
$N_{Rd,p} = N_{Rd,b}$ ( $C_{cr} = C_{min} = 200$ mm)	HIT-V + HIT-SC	M8, M10, M12	80	4	0,4		
	HAS-U + HIT-SC	M8, M10, M12		10	0,5	0,6	
	HIT-IC + HIT-SC	M8, M10, M12					
$V_{Rd,b}$ ( $C_{cr} = C_{min} = 200$ mm)	HIT-V + HIT-SC	M8, M10, M12	80	4	1,0		
	HAS-U + HIT-SC	M8, M10, M12		10	1,6		
	HIT-IC + HIT-SC	M8, M10, M12					

### Design tension and shear resistances – Pull out and pushing out of one brick failures

#### Pull out of one brick (tension):

$$N_{Rd,pb} = 2 \cdot l \cdot b \cdot (0,5 \cdot f_{vko} + 0,4 \cdot \sigma_d) / (2,5 \cdot 1000) \text{ [kN]}$$

$$N_{Rd,pb}^* = (2 \cdot l \cdot b \cdot (0,5 \cdot f_{vko} + 0,4 \cdot \sigma_d) + b \cdot h \cdot f_{vko}) / (2,5 \cdot 1000) \text{ [kN]}$$

\* this equation is applicable if the vertical joints are filled

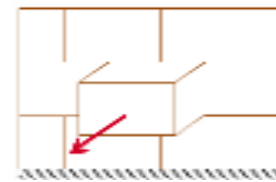

#### Pushing out of one brick (shear):

$$V_{Rd,pb} = 2 \cdot l \cdot b \cdot (0,5 \cdot f_{vko} + 0,4 \cdot \sigma_d) / (2,5 \cdot 1000) \text{ [kN]}$$

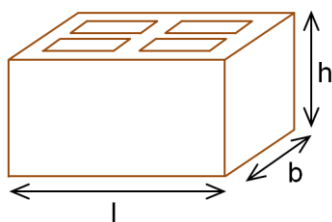
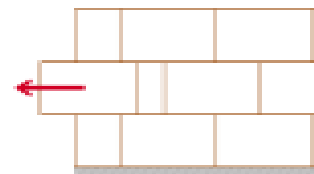

$\sigma_d$  = design compressive stress perpendicular to the shear (N/mm<sup>2</sup>)  
 $f_{vko}$  = initial shear strength according to EN 1996-1-1, Table 3.4

Brick type	Mortar strength	$f_{vko}$ [N/mm <sup>2</sup> ]
Clay brick	M2,5 to M9	0,20
	M10 to M20	0,30
All other types	M2,5 to M9	0,15
	M10 to M20	0,20

**On-site test**

For other bricks in solid or hollow masonry, not covered by the Hilti HIT-HY 170 ETA or this technical data manual, the characteristic resistance may be determined by on-site tension tests (pull-out tests or proof-load tests), according to EOTA TR 053.

For the evaluation of test results, the characteristic resistance shall be obtained taking into account the  $\beta$  factor, which considers the different influences of the product.

The  $\beta$  factor for the brick types covered by the Hilti HIT-HY 170 ETA is provided in the following table:

Use categories		w/w and w/d		d/d	
Temperature range		Ta*	Tb*	Ta*	Tb*
Base material	Elements				
Solid clay brick	HIT-V, HAS-U or HIT-IC	0,97	0,83	0,97	0,83
	HIT-V + HIT-SC				
	HAS-U + HIT-SC				
	HIT-IC + HIT-SC				
Solid calcium silicate brick	HIT-V, HAS-U or HIT-IC	0,96	0,84	0,97	0,84
	HIT-V + HIT-SC	0,69	0,62	0,91	0,82
	HAS-U + HIT-SC				
	HIT-IC + HIT-SC				
Hollow clay brick	HIT-V + HIT-SC	0,97	0,83	0,97	0,83
	HAS-U + HIT-SC				
	HIT-IC + HIT-SC				
Hollow calcium silicate brick	HIT-V + HIT-SC	0,69	0,62	0,91	0,82
	HAS-U + HIT-SC				
	HIT-IC + HIT-SC				
Hollow lightweight concrete brick	HIT-V + HIT-SC	0,89	0,81	0,97	0,86
	HAS-U + HIT-SC				
	HIT-IC + HIT-SC				
Hollow normal weight concrete brick	HIT-V + HIT-SC	0,97	0,80	0,97	0,80
	HAS-U + HIT-SC				
	HIT-IC + HIT-SC				

\*Ta / Tb, w/w and d/d anchorage parameters, as defined on Tables pages 8-9

Applying the  $\beta$  factor from the table above, the characteristic tension resistance  $N_{Rk}$  can be obtained. Characteristic shear resistance  $V_{Rk}$  can also be directly derived from  $N_{Rk}$ . For detailed procedure consult EOTA TR 053.



## Materials

### Material quality

Part	Material
<b>Zinc coated steel</b>	
Threaded rod, HIT-V 5.8 (F) HAS-U 5.8 (HDG)	Strength class 5.8; Elongation at fracture A5 > 8% ductile Electroplated zinc coated $\geq 5\mu\text{m}$ ; (HDG), (F) hot dip galvanized $\geq 45\mu\text{m}$
Threaded rod, HIT-V 8.8 (F) HAS-U 8.8 (HDG)	Strength class 8.8; Elongation at fracture A5 > 12% ductile Electroplated zinc coated $\geq 5\mu\text{m}$ ; (HDG), (F) hot dip galvanized $\geq 45\mu\text{m}$
Washer	Electroplated zinc coated $\geq 5\mu\text{m}$ , hot dip galvanized $\geq 45\mu\text{m}$
Nut	Strength class of nut adapted to strength class of threaded rod. Electroplated zinc coated $\geq 5\mu\text{m}$ , hot dip galvanized $\geq 45\mu\text{m}$
Internally threaded sleeve HIT-IC	A5 > 8% ductile Electroplated zinc coated $\geq 5\mu\text{m}$
<b>Stainless Steel</b>	
Threaded rod, HIT-V-R HAS-U A4	Strength class 70 for M8-M12 Elongation at fracture A5 > 8% ductile Stainless steel 1.4401; 1.4404; 1.4578; 1.4571; 1.4439; 1.4362
Washer	Stainless steel 1.4401, 1.4404, 1.4578, 1.4571, 1.4439, 1.4362 EN 10088-1:2014
Nut	Stainless steel 1.4401, 1.4404, 1.4578, 1.4571, 1.4439, 1.4362 EN 10088-1:2014
<b>High corrosion resistant steel</b>	
Threaded rod, HIT-V-HCR HAS-U HCR	Strength class 80 for M8-M12 Elongation at fracture A5 > 8% ductile High corrosion resistance steel 1.4529; 1.4565;
Washer	High corrosion resistant steel 1.4529, 1.4565 EN 10088-1:2014
Nut	High corrosion resistant steel 1.4529, 1.4565 EN 10088-1:2014
<b>Sieve sleeve</b>	
Sieve sleeve HIT-SC	Frame: Polyfort FPP 20T Sieve: PA6.6 N500/200

### Base materials:

- Solid brick masonry. The characteristic resistances are also valid for larger brick sizes and larger compressive strengths of the masonry unit.
- Hollow brick masonry
- Mortar strength class of the masonry: M2,5 at minimum according to EN 998-2: 2010.
- For other bricks in solid masonry and in hollow or perforated masonry, the characteristic resistance of the anchor may be determined by on-site tests according to EOTA TR 053 under consideration of the  $\beta$ -factor according to Table page 9.

## Setting information

### Installation temperature range

#### For solid masonry:

-5°C to +40°C (HIT-V, HIT-IC)

0°C to +40°C (HAS-U)

#### For hollow masonry:

+5°C to +40°C (HIT-V, HAS-U, HIT-IC with HIT-SC)

### In service temperature range

Hilti HIT-HY 170 injection mortar may be applied in the temperature ranges given below. An elevated base material temperature may lead to a reduction of the design bond resistance.

Temperature range	Base material temperature	Maximum long term base material temperature	Maximum short term base material temperature
Temperature range I	-40 °C to + 40 °C	+ 24 °C	+ 40 °C
Temperature range II	-40 °C to + 80 °C	+ 50 °C	+ 80 °C

### Maximum short term base material temperature

Short term elevated base material temperatures are those that occur over brief intervals, e.g. as a result of diurnal cycling.

### Maximum long term base material temperature

Long term elevated base material temperatures are roughly constant over significant periods of time.

### Working time and curing time <sup>a)</sup>

Temperature of the base material	Maximum working time	Minimum curing time
$T_{BM}$	$t_{work}$	$t_{cure}^{a)}$
$-5\text{ °C} \leq T_{BM} \leq 0\text{ °C}^{a)}$	10 min	12 h
$0\text{ °C} \leq T_{BM} \leq 5\text{ °C}^{a)}$	10 min	5 h
$5\text{ °C} \leq T_{BM} \leq 10\text{ °C}$	8 min	2,5 h
$10\text{ °C} \leq T_{BM} \leq 20\text{ °C}$	5 min	1,5 h
$20\text{ °C} \leq T_{BM} \leq 30\text{ °C}$	3 min	45 min
$30\text{ °C} \leq T_{BM} \leq 40\text{ °C}$	2 min	30 min

The curing time data are valid for dry base material only. In wet base material the curing times must be doubled.

a) Data valid for hollow bricks only

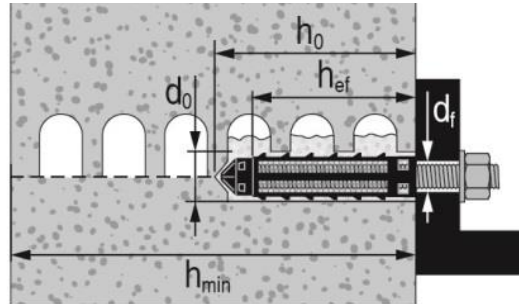
**Installation Parameters**
**Single sieve sleeve, 50mm >  $h_{ef}$  > 80mm**

**Installation parameters of HIT-V, HAS-U with sieve sleeve HIT-SC in hollow and solid brick**

Threaded rods and HIT-V, HAS-U		M8	M10	M12
<b>with HIT-SC</b>		<b>16x85</b>		<b>18x85</b>
Nominal diameter of drill bit	$d_0$ [mm]	16	16	18
Drill hole depth	$h_0$ [mm]	95	95	95
Effective embedment depth	$h_{ef}$ [mm]	80	80	80
Maximum diameter of clearance hole in the fixture	$d_f$ [mm]	9	12	14
Minimum wall thickness	$h_{min}$ [mm]	115	115	115
Brush HIT-RB		16	16	18
Number of strokes HDM		6	6	8
Number of strokes HDE 500-A		5	5	6
Maximum torque moment for all brick types except "parpaing creux"	$T_{max}$ [Nm]	3	4	6
Maximum torque moment for "parpaing creux"	$T_{max}$ [Nm]	2	2	3

**Installation parameters of HIT-IC with HIT-SC in hollow and solid brick**

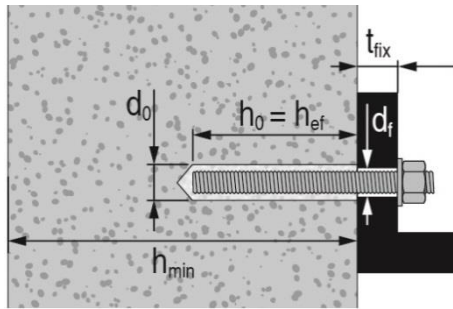
HIT-IC		M8	M10	M12
<b>with HIT-SC</b>		<b>16x85</b>	<b>18x85</b>	<b>22x85</b>
Nominal diameter of drill bit	$d_0$ [mm]	16	18	22
Drill hole depth	$h_0$ [mm]	95	95	95
Effective embedment depth	$h_{ef}$ [mm]	80	80	80
Thread engagement length	$h_s$ [mm]	8...75	10...75	12...75
Maximum diameter of clearance hole in the fixture	$d_f$ [mm]	9	12	14
Minimum wall thickness	$h_{min}$ [mm]	115	115	115
Brush HIT-RB		16	18	22
Number of strokes HDM		6	8	10
Number of strokes HDE-500		5	6	8
Maximum torque moment	$T_{max}$ [Nm]	3	4	6

**Solid bricks without sieve sleeves <sup>a)</sup>**

**Installation parameters of HIT-V, HAS-U in solid bricks**

Threaded rods and HIT-V, HAS-U		M8	M10	M12
Nominal diameter of drill bit	$d_0$ [mm]	10	12	14
Drill hole depth = Effective embedment depth	$h_0 = h_{ef}$ [mm]	50...300	50...300	50...300
Maximum diameter of clearance hole in the fixture	$d_f$ [mm]	9	12	14
Minimum wall thickness	$h_{min}$ [mm]	$h_0 + 30$	$h_0 + 30$	$h_0 + 30$
Brush HIT-RB		10	12	14
Maximum torque moment	$T_{max}$ [Nm]	5	8	10

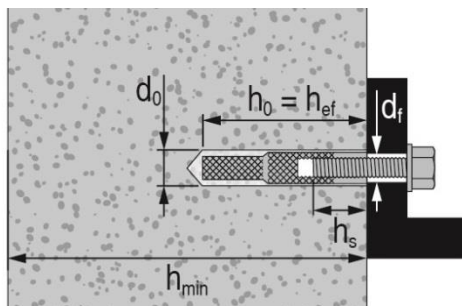
a) Hilti recommends the anchoring in masonry always with sieve sleeve. Anchors can only be installed without sieve sleeves in solid bricks when it is guaranteed that it has not any hole or void.

**Installation parameters of HIT-IC in solid bricks**

HIT-IC		M8x80	M10x80	M12x80
Nominal diameter of drill bit	$d_0$ [mm]	14	16	18
Drill hole depth = Effective embedment depth	$h_0 = h_{ef}$ [mm]	80	80	80
Thread engagement length	$h_s$ [mm]	8...75	10...75	12...75
Maximum diameter of clearance hole in the fixture	$d_f$ [mm]	9	12	14
Minimum wall thickness	$h_{min}$ [mm]	115	115	115
Brush HIT-RB		14	16	18
Maximum torque moment	$T_{max}$ [Nm]	5	8	10

a) Hilti recommends the anchoring in masonry always with sieve sleeve. Anchors can only be installed without sieve sleeves in solid bricks when it is guaranteed that it has not any hole or void.

**Installation equipment**

Anchor size	M8	M10	M12
Rotary hammer	TE2(A) – TE30(A)		
Other tools	compressed air gun or blow out pump, set of cleaning brushes, dispenser		

**Drilling and cleaning parameters**

HAS-U, HIT-V <sup>a)</sup>	HAS-U, HIT-V + sieve sleeve	HIT-IC <sup>a)</sup>	HIT-IC + sieve sleeve	Drilling and cleaning	
				Hammer drill	Brush HIT-RB
				d <sub>0</sub> [mm]	size [mm]
<b>M8</b>	-	-	-	10	10
<b>M10</b>	-	-	-	12	12
<b>M12</b>	-	<b>M8</b>	-	14	14
-	<b>M8</b>	-	-	16	16
-	<b>M10</b>	<b>M10</b>	<b>M8</b>	16	16
-	<b>M12</b>	<b>M12</b>	<b>M10</b>	18	18
-	-	-	<b>M12</b>	22	22

a) Installation without the sieve sleeve HIT-SC can be used only in case of solid bricks.

## Setting instructions

\*For detailed information on installation see instruction for use given with the package of the product.



### Safety regulations.

Review the Material Safety Data Sheet (MSDS) before use for proper and safe handling! Wear well-fitting protective goggles and protective gloves when working with Hilti HIT-HY 170.

### Drilling

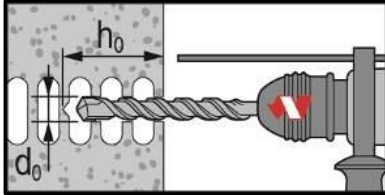

In hollow bricks: rotary mode

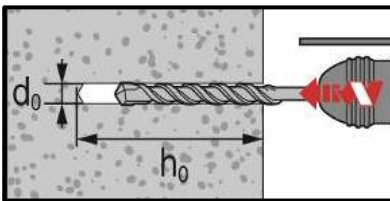

In solid bricks: hammer mode

### Cleaning

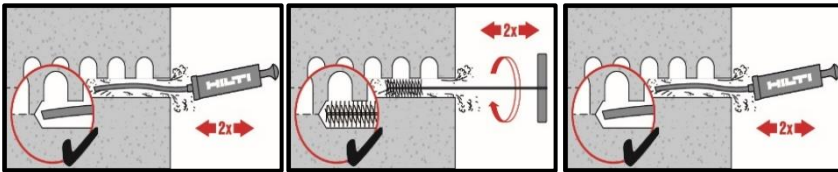

Manual cleaning (MC)

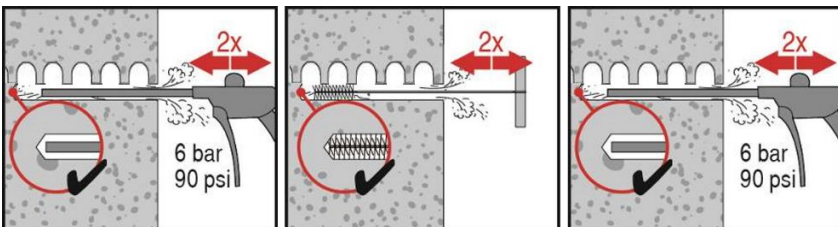

Compressed air cleaning (CAC)

### Instructions for solid bricks without sieve sleeve

#### Injection system

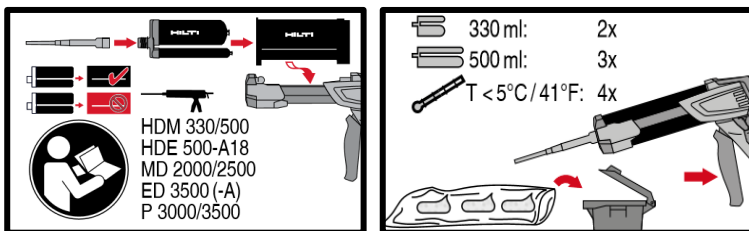

Injection system preparation.

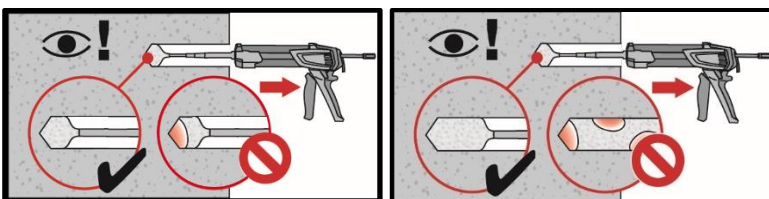

Injection method for drill hole

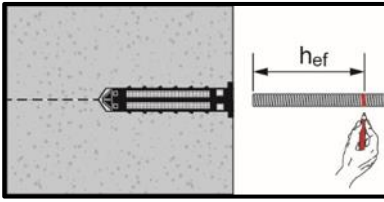
**Setting the element**

**Presetting element**, observe working time “ $t_{work}$ ”,

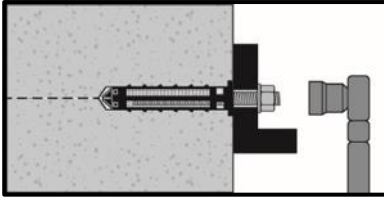

**Loading the anchor**: After required curing time  $t_{cure}$  the anchor can be loaded.

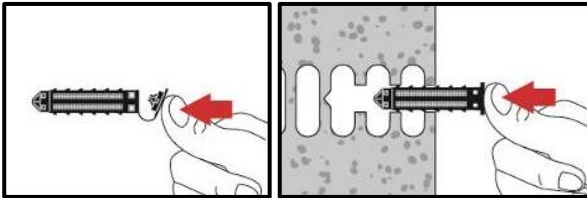
**Instructions for hollow and solid bricks with sieve sleeve**
**Preparation of the sieve sleeve**

Close lid and insert sieve sleeve manually

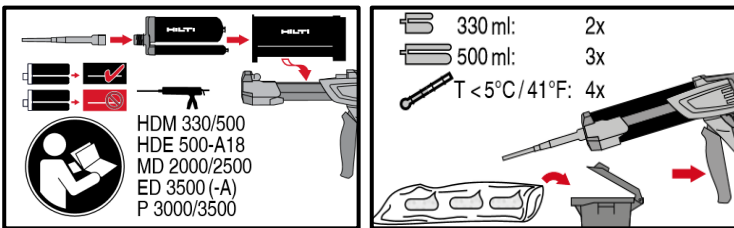
**Injection system**

Injection system preparation.

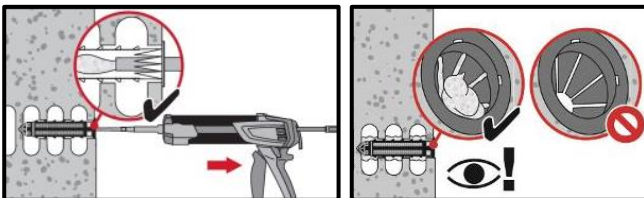
**Injection system: hollow bricks**

Installation with sieve sleeve HIT-SC

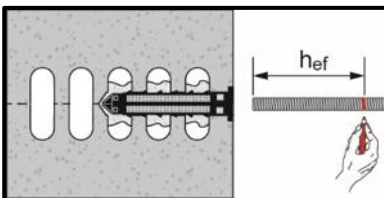
**Setting the element**

**Presetting element**, observe working time “ $t_{work}$ ”,

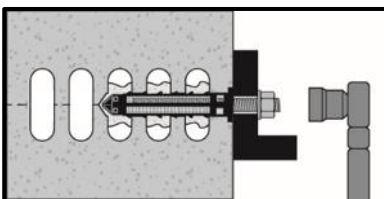

**Loading the anchor**: After required curing time  $t_{cure}$  the anchor can be loaded.

# HIT-HY 170 injection mortar

## Anchor design (EN 1992-4) / Rebar elements / Concrete

Injection mortar system	Benefits
 <p data-bbox="798 403 1005 448">Hilti HIT-HY 170</p> <p data-bbox="798 481 1005 593">500 ml foil pack (also available as 330 ml foil pack)</p> <p data-bbox="798 728 1005 817">Rebar B500 B (<math>\phi 8</math>-<math>\phi 25</math>)</p>	<ul style="list-style-type: none"> <li>- Suitable for non-cracked and cracked concrete C 12/15 to C 50/60</li> <li>- Suitable for dry and water saturated concrete</li> <li>- High loading capacity and fast cure</li> <li>- In service temperature range up to 80°C short term/50°C long term</li> <li>- Manual cleaning for drill hole sizes <math>\leq 18</math> mm and embedment depth <math>h_{ef} \leq 10d</math></li> </ul>

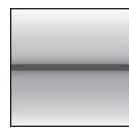
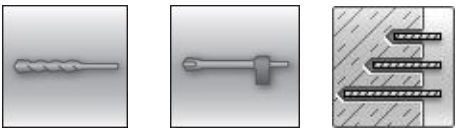
Base material	Load conditions
 <p data-bbox="119 1131 279 1198">Concrete (non-cracked)</p> <p data-bbox="295 1131 454 1164">Dry concrete</p> <p data-bbox="470 1131 630 1164">Wet concrete</p>	 <p data-bbox="821 1131 957 1198">Static/ quasi-static</p>
Installation conditions	Other information
 <p data-bbox="143 1400 263 1467">Hammer drilling</p> <p data-bbox="295 1400 438 1467">Hollow drill-bit drilling</p> <p data-bbox="478 1400 622 1489">Variable embedment depth</p>	

### Approvals / certificates

Description	Authority / Laboratory	No. / date of issue
Hilti Technical Data <sup>a)</sup>	Hilti	2017-11-28

a) All data given in this section according to Hilti Technical Data.



## Static and quasi-static loading (for a single anchor)

### All data in this section applies to

- Correct setting (see setting instruction)
- No edge distance and spacing influence
- Steel failure
- Base material thickness, as specified in the table
- Embedment depth, as specified in the table
- Anchor material, as specified in the tables
- Concrete C 20/25,  $f_{ck,cube} = 25 \text{ N/mm}^2$
- In-service Temperature range I  
(min. base material temperature  $-40^\circ\text{C}$ , max. long term/short term base material temperature:  $+50^\circ\text{C}/80^\circ\text{C}$ )

### Embedment depth <sup>a)</sup> and base material thickness

Anchor size		φ8	φ10	φ12	φ14	φ16	φ18	φ20	φ22	φ24	φ25
Embedment depth	$h_{ef}$ [mm]	80	90	110	125	145	155	170	185	200	210
Base material thickness	$h$ [mm]	110	120	140	161	185	199	220	237	256	274

a) The allowed range of embedment depth is shown in the setting details.

### Characteristic resistance

Anchor size		φ8	φ10	φ12	φ14	φ16	φ18	φ20	φ22	φ24	φ25
Tensile	$N_{Rk}$ [kN]	20,1	28,3	41,5	55,0	72,9	87,7	106,8	123,8	139,1	149,7
Shear	$V_{Rk}$ [kN]	14,0	22,0	31,0	42,0	55,0	70,0	86,0	104,0	124,0	135,0

### Design resistance

Anchor size		φ8	φ10	φ12	φ14	φ16	φ18	φ20	φ22	φ24	φ25
Tensile	$N_{Rd}$ [kN]	13,4	18,8	27,6	36,6	48,6	58,4	71,2	82,5	92,8	99,8
Shear	$V_{Rd}$ [kN]	11,2	17,6	24,8	33,6	44,0	56,0	68,8	83,2	99,2	108,0

### Recommended loads <sup>a)</sup>

Anchor size		φ8	φ10	φ12	φ14	φ16	φ18	φ20	φ22	φ24	φ25
Tensile	$N_{Rec}$ [kN]	9,6	13,5	19,7	26,2	34,7	41,7	50,9	58,9	66,3	71,3
Shear	$V_{Rec}$ [kN]	8,0	12,6	17,7	24,0	31,4	40,0	49,1	59,4	70,9	77,1

a) With overall partial safety factor for action  $\gamma = 1,4$ . The partial safety factors for action depend on the type of loading and shall be taken from national regulations.

## Materials

### Mechanical properties

Anchor size		φ8	φ10	φ12	φ14	φ16	φ18	φ20	φ22	φ24	φ25
Nominal tensile strength	$f_{uk}$ [N/mm <sup>2</sup> ]	550	550	550	550	550	550	550	550	550	550
Yield strength	$f_{yk}$ [N/mm <sup>2</sup> ]	500	500	500	500	500	500	500	500	500	500
Stressed cross-section	$A_s$ [mm <sup>2</sup> ]	50,3	78,5	113,1	153,9	201,1	254,0	314,2	380	452	490,9
Moment of resistance	$W$ [mm <sup>3</sup> ]	50,3	98,2	169,6	269,4	402,1	572,6	785,4	1045,3	1357,2	1534

### Material quality

Part	Material
Rebar EN 1992-1-1	Bars and de-coiled rods class B or C with $f_{yk}$ and $k$ according to NDP or NCL of EN 1992-1-1 $f_{uk} = f_{tk} = k \cdot f_{yk}$

## Setting information

### Installation temperature

-5°C to +40°C

### Service temperature range

Hilti HIT-HY 170 injection mortar may be applied in the temperature ranges given below. An elevated base material temperature may lead to a reduction of the design bond resistance.

Temperature range	Base material temperature	Maximum long term base material temperature	Maximum short term base material temperature
Temperature range I	- 40 °C to + 40 °C	+ 24 °C	+ 40 °C
Temperature range II	- 40 °C to + 80 °C	+ 50 °C	+ 80 °C

### Maximum short term base material temperature

Short term elevated base material temperatures are those that occur over brief intervals, e.g. as a result of diurnal cycling.

### Maximum long term base material temperature

Long term elevated base material temperatures are roughly constant over significant periods of time.

### Working time and curing time

Temperature of the base material	Maximum working time	Minimum curing time
$T_{BM}$	$t_{work}$	$t_{cure}^a)$
$-5\text{ °C} \leq T_{BM} \leq 0\text{ °C}^a)$	10 min	12 h
$0\text{ °C} \leq T_{BM} \leq 5\text{ °C}^a)$	10 min	5 h
$5\text{ °C} \leq T_{BM} \leq 10\text{ °C}$	8 min	2,5 h
$10\text{ °C} \leq T_{BM} \leq 20\text{ °C}$	5 min	1,5 h
$20\text{ °C} \leq T_{BM} \leq 30\text{ °C}$	3 min	45 min
$30\text{ °C} \leq T_{BM} \leq 40\text{ °C}$	2 min	30 min

a) The curing time data are valid for dry base material only. In wet base material the curing times must be doubled.

### Installation equipment

Rebar size	Ø8	Ø10	Ø12	Ø14	Ø16	Ø18	Ø20	Ø22	Ø24	Ø25
Rotary hammer	TE2(-A) – TE30(-A)					TE40 – TE80				
Other tools	Blow out pump ( $h_{ef} \leq 10 \cdot d$ and $d_0 \leq 20\text{ mm}$ ) or Compressed air gun <sup>a)</sup> Set of cleaning brushes <sup>b)</sup> , dispenser, piston plug									

a) Compressed air gun with extension hose for all drill holes deeper than 250 mm (for  $\phi$  8 to  $\phi$  12) or deeper than  $20 \cdot \phi$  (for  $\phi > 12$  mm)

b) Automatic brushing with round brush for all drill holes deeper than 250 mm (for  $\phi$  8 to  $\phi$  12) or deeper than  $20 \cdot \phi$  (for  $\phi > 12$  mm)

**Setting details**

Anchor size			Ø8	Ø10	Ø12	Ø14	Ø16	Ø18	Ø20	Ø22	Ø24	Ø25	
Nominal diameter of element	d	[mm]	8	10	12	14	16	18	20	22	24	25	
Nominal diameter of drill bit	d <sub>0</sub>	[mm]	10 / 12 <sup>a)</sup>	12 / 14 <sup>a)</sup>	14 <sup>a)</sup>	16 <sup>a)</sup>	18	20	22	25	28	32	
Effective anchorage depth (=drill hole depth) <sup>b)</sup>	$h_{ef,min} = h_{0,min}$	[mm]	60	60	70	70	75	80	85	90	95	100	100
	$h_{ef,max} = h_{0,max}$	[mm]	96	120	144	144	168	192	216	240	264	288	300
Minimum base material thickness	$h_{min}$	[mm]	$h_{ef} + 30 \text{ mm}$ $\geq 100 \text{ mm}$			$h_{ef} + 2 d_0$							
Minimum spacing	$s_{min}$	[mm]	40	50	60	60	70	80	90	100	110	120	125
Minimum edge distance	$c_{min}$	[mm]	40	50	60	60	70	80	90	100	110	120	125
Critical spacing for splitting failure	$s_{cr,sp}$	[mm]	$2 C_{cr,sp}$										
Critical edge distance for splitting failure <sup>c)</sup>	$C_{cr,sp}$	[mm]	$1,0 \cdot h_{ef}$		for $h / h_{ef} \geq 2,0$								
			$4,6 h_{ef} - 1,8 h$		for $2,0 > h / h_{ef} > 1,3$								
			$2,26 h_{ef}$		for $h / h_{ef} \leq 1,3$								
Critical spacing for concrete cone failure	$s_{cr,N}$	[mm]	$2 C_{cr,N}$										
Critical edge distance for concrete cone failure <sup>d)</sup>	$C_{cr,N}$	[mm]	$1,5 h_{ef}$										

For spacing (edge distance) smaller than critical spacing (critical edge distance) the design loads have to be reduced.

a) Both given values for drill bit diameter can be used

b)  $h_{ef,min} \leq h_{ef} \leq h_{ef,max}$  ( $h_{ef}$ : embedment depth)

c)  $h$ : base material thickness ( $h \geq h_{min}$ )

d) The critical edge distance for concrete cone failure depends on the embedment depth  $h_{ef}$  and the design bond resistance. The simplified formula given in this table is on the safe side.

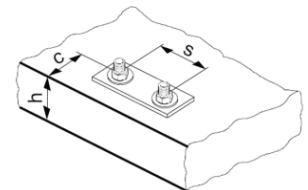
**Drilling and cleaning parameters**

Rebar	Drilling and cleaning			Installation
	Hammer drill (HD)	Hollow Drill Bit (HDB)	Brush HIT-RB	Piston plug HIT-SZ
	d <sub>0</sub> [mm]		size [mm]	size [mm]
Ø8	10 / 12 <sup>a)</sup>	-	10 / 12 <sup>a)</sup>	- / 12
Ø10	12 / 14 <sup>a)</sup>	14	12 / 14 <sup>a)</sup>	12 / 14 <sup>a)</sup>
Ø12	14 / 16 <sup>a)</sup>	16 (14 <sup>a)</sup> )	14 / 16 <sup>a)</sup>	14 / 16 <sup>a)</sup>
Ø14	18	18	18	18
Ø16	20	20	20	20
Ø18	22	22	22	22
Ø20	25	25	25	25
Ø22	28	28	28	28
Ø24	32	32	32	32
Ø25	32	32	32	32

a) Each of the two given values can be used

## Setting instructions

**\*For detailed information on installation see instruction for use given with the package of the product.**



### Safety regulations.

Review the Material Safety Data Sheet (MSDS) before use for proper and safe handling! Wear well-fitting protective goggles and protective gloves when working with Hilti HIT-HY 170.

### Drilling

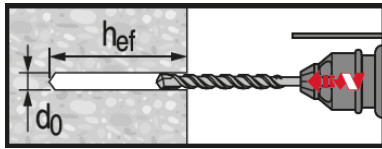

#### Hammer drilled hole

For dry and wet concrete.

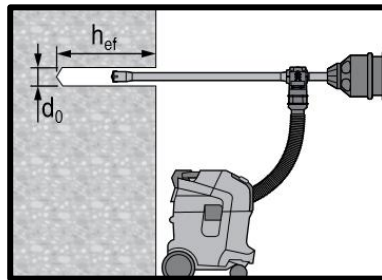

#### Hammer drilled hole with Hollow Drilled Bit (HDB)

No cleaning required.

### Cleaning

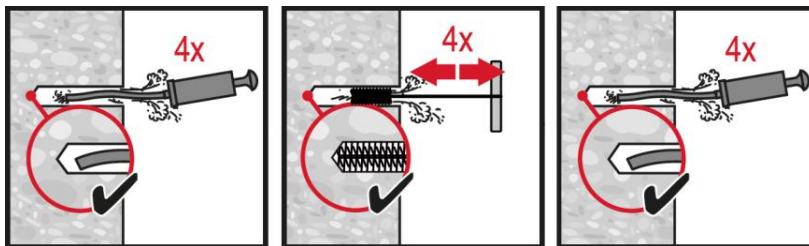

#### Manual cleaning (MC)

for drill diameters  $d_0 \leq 20$  mm and drill hole depth  $h_0 \leq 10 \cdot d$ .

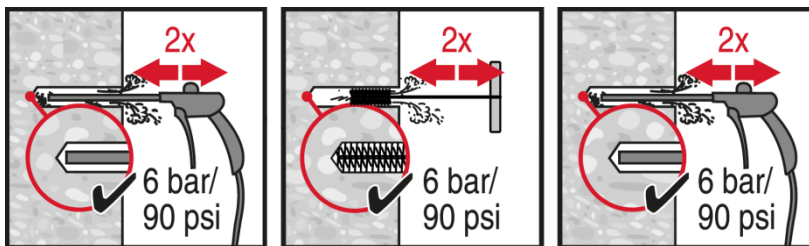

#### Compressed air cleaning (CAC)

for all drill hole diameters  $d_0$  and drill hole depths  $h_0 \leq 20 \cdot d$ .

**Injection system**

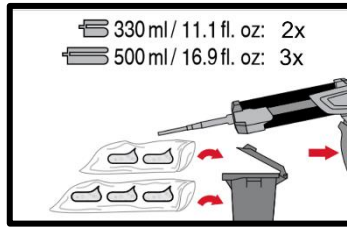
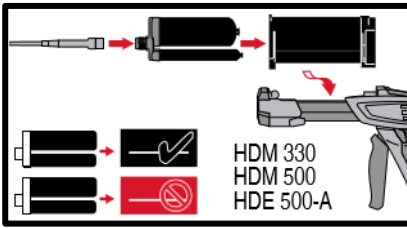

**Injection system preparation.**

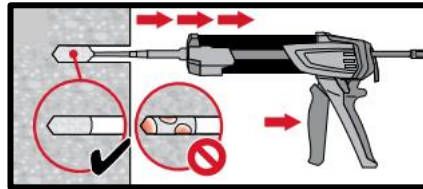
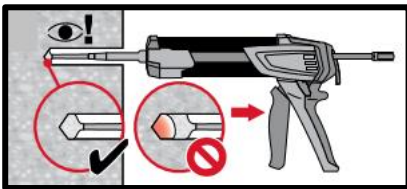

**Injection method for drill hole depth**  
 $h_{ef} \leq 250 \text{ mm.}$

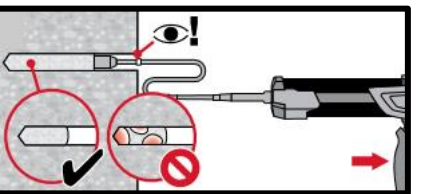
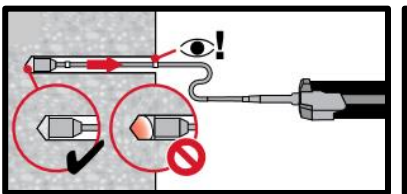

**Injection method for drill hole depth**  
 $h_{ef} > 250 \text{ mm.}$

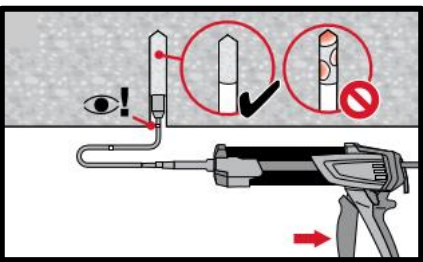
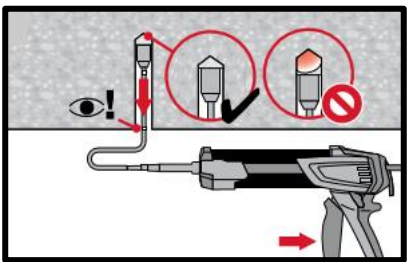

**Injection method for overhead**  
**application.**

**Setting the element**

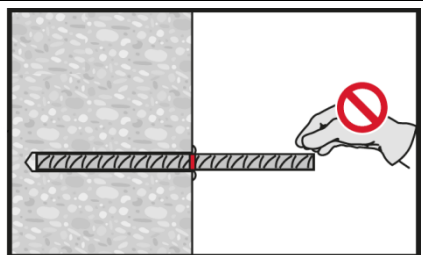
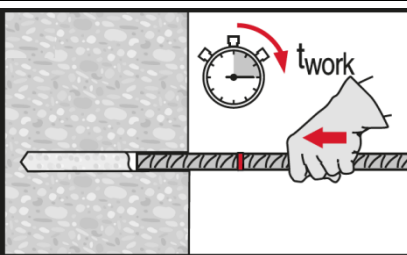

**Setting element, observe working time**  
“ $t_{work}$ ”.

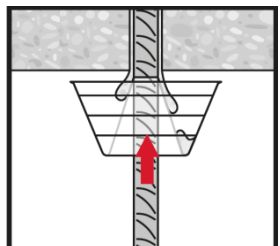
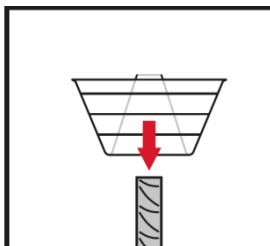
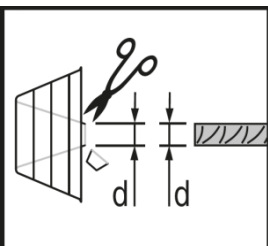

**Setting element for overhead**  
**applications, observe working time** “ $t_{work}$ ”.

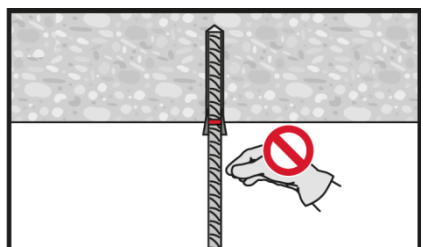
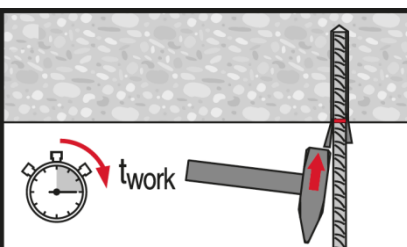

**Loading the anchor:** After required  
curing time  $t_{cure}$  the anchor can be  
loaded.

# HIT-HY 170 injection mortar

Rebar design (EN 1992-1) / Rebar elements / Concrete

## Injection mortar system



Hilti HIT-HY 170  
330 ml foil pack

(also available  
as 500 ml foil  
pack)



Rebar B500 B  
( $\phi 8 - \phi 25$ )

## Benefits

- Suitable for concrete C12/15 to C50/60
- Suitable for dry and water saturated concrete
- High loading capacity and fast cure
- High corrosion resistant
- For rebar diameters up to 25 mm
- Manual cleaning for drill hole sizes  $\leq 20$  mm and embedment depth  $h_{ef} \leq 10d$
- Suitable for embedment depth up to 1000 mm depending on the rebar diameter

## Base material



Concrete  
(Non-cracked)

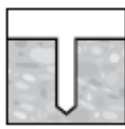

Dry  
concrete

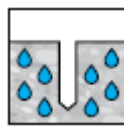

Water  
saturated  
concrete

## Load conditions

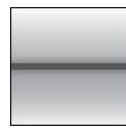

Static/  
quasi-static



Fire  
resistance

## Installation conditions



Hammer  
drilled holes

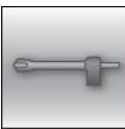

Hollow drill-  
bit drilling

## Other informations



European  
Technical  
Assessment



CE  
conformity

## Approvals / certificates

Description	Authority / Laboratory	No. / date of issue
European Technical Assessment <sup>a)</sup>	DIBt, Berlin	ETA-15/0297 / 2015-12-11

b) All data given in this section according to ETA-15/0297 issue 2015-12-11.

## Static and quasi-static loading

### Design bond strength

Design bond strength in N/mm<sup>2</sup> accord. to ETA-15/0297 for good bond conditions

All allowed drilling methods									
Rebar - size	Concrete class								
	C12/15	C16/20	C20/25	C25/30	C30/37	C35/45	C40/50	C45/55	C50/60
φ8 - φ12	1,6	2,0	2,3	2,7	3,0	3,4	3,7	3,7	3,7
φ14 - φ25	1,6	2,0	2,3	2,7	3,0	3,4	3,4	3,4	3,4

For all other bond conditions multiply the values by 0,7.

### Minimum anchorage length and minimum lap length

The minimum anchorage length  $l_{b,min}$  and the minimum lap length  $l_{0,min}$  according to EN 1992-1-1 shall be multiplied by the relevant **Amplification factor**  $\alpha_{lb}$  in the table below.

**Amplification factor  $\alpha_{lb}$  for the min. anchorage length and min. lap length according to EN 1992-1-1 for:**

All allowed drilling methods									
Rebar - size	Concrete class								
	C12/15	C16/20	C20/25	C25/30	C30/37	C35/45	C40/50	C45/55	C50/60
φ8 - φ25	1,0								

### Pre-calculated values

#### Pre-calculated values<sup>1)</sup> – anchorage length

Rebar yield strength  $f_{yk}=500$  N/mm<sup>2</sup>, concrete C25/30, good bond conditions

Rebar [mm]	Anchorage length $l_{bd}$ [mm]	Design value $N_{Rd}$ [kN]	Mortar volume <sup>2)</sup> $V_M$ [ml]	Anchorage length $l_{bd}$ [mm]	Design value $N_{Rd}$ [kN]	Mortar volume <sup>2)</sup> $V_M$ [ml]
	$\alpha_1=\alpha_2=\alpha_3=\alpha_4=\alpha_5=1,0$				$\alpha_1 = \alpha_3 = \alpha_4 = 1,0 \quad \alpha_2 \text{ or } \alpha_5 = 0,7$	
φ8	100	6,8	8	100	9,7	8
	170	11,5	13	140	13,6	11
	250	17,0	19	180	17,4	14
	<b>322</b>	<b>21,9</b>	24	<b>226</b>	<b>21,9</b>	17
φ10	121	10,3	11	121	14,7	11
	220	18,7	20	170	20,6	15
	310	26,3	28	230	27,9	21
	<b>403</b>	<b>34,2</b>	36	<b>281</b>	<b>34,1</b>	25
φ12	145	14,8	15	145	21,1	15
	260	26,5	27	210	30,5	22
	370	37,7	39	270	39,3	29
	<b>483</b>	<b>49,2</b>	51	<b>338</b>	<b>49,1</b>	36
φ14	169	20,1	20	169	28,7	20
	300	35,6	36	240	40,7	29
	430	51,1	52	320	54,3	39
	<b>564</b>	<b>67,0</b>	68	<b>394</b>	<b>66,8</b>	48
φ16	193	26,2	26	193	37,4	26
	340	46,1	46	280	54,3	38
	490	66,5	67	370	71,7	50
	<b>644</b>	<b>87,4</b>	87	<b>451</b>	<b>87,4</b>	61
φ18	217	33,1	33	217	47,3	33
	380	58,0	57	310	67,6	47
	540	82,4	81	410	89,4	62
	<b>700</b>	<b>106,9</b>	106	<b>507</b>	<b>110,6</b>	76
φ20	242	41,1	51	242	58,6	51
	390	66,2	83	350	84,8	74
	550	93,3	117	460	111,5	98
	<b>700</b>	<b>118,8</b>	148	<b>564</b>	<b>136,7</b>	120



**Pre-calculated values<sup>1)</sup> – anchorage length**

 Rebar yield strength  $f_{yk}=500$  N/mm<sup>2</sup>, concrete C25/30, good bond conditions

Rebar [mm]	Anchorage length $l_{bd}$ [mm]	Design value $N_{Rd}$ [kN]	Mortar volume <sup>2)</sup> $V_M$ [ml]	Anchorage length $l_{bd}$ [mm]	Design value $N_{Rd}$ [kN]	Mortar volume <sup>2)</sup> $V_M$ [ml]
	$\alpha_1=\alpha_2=\alpha_3=\alpha_4=\alpha_5=1,0$					
φ22	266	49,6	75	266	70,9	75
	410	76,5	116	380	101,3	107
	560	104,5	158	500	133,3	141
	<b>700</b>	<b>130,6</b>	198	<b>620</b>	<b>165,3</b>	175
φ24	290	59,0	122	290	84,3	122
	430	87,5	182	420	122,1	177
	560	114,0	236	550	160,0	232
	<b>700</b>	<b>142,5</b>	296	<b>676</b>	<b>196,6</b>	285
φ25	302	64,0	114	302	91,5	114
	430	91,2	162	430	130,3	162
	570	120,9	214	570	172,7	214
	<b>700</b>	<b>148,4</b>	263	<b>700</b>	<b>212,1</b>	263

1) Values corresponding to the minimum anchorage length. The maximum permissible load is valid for "good bond conditions" as described in EN 1992-1-1. For all other conditions multiply by the value by 0,7.

 2) The volume of mortar corresponds to the formula " $1,2 \cdot (d_o^2 - d_s^2) \cdot \pi \cdot l_{bd} / 4$ " for hammer drilling

**Pre-calculated values<sup>1)</sup> – overlap length**

 Rebar yield strength  $f_{yk}=500$  N/mm<sup>2</sup>, concrete C25/30, good bond conditions

Rebar [mm]	Overlap length $l_o$ [mm]	Design value $N_{Rd}$ [kN]	Mortar volume <sup>2)</sup> $V_M$ [ml]	Overlap length $l_o$ [mm]	Design value $N_{Rd}$ [kN]	Mortar volume <sup>2)</sup> $V_M$ [ml]
	$\alpha_1=\alpha_2=\alpha_3=\alpha_4=\alpha_5=1,0$					
φ8	200	13,6	15	200	19,4	15
	240	16,3	18	210	20,4	16
	280	19,0	21	220	21,3	17
	<b>322</b>	<b>21,9</b>	24	<b>226</b>	<b>21,9</b>	17
φ10	200	17,0	18	200	24,2	18
	270	22,9	24	230	27,9	21
	340	28,8	31	250	30,3	23
	<b>403</b>	<b>34,2</b>	36	<b>281</b>	<b>34,1</b>	25
φ12	200	20,4	21	200	29,1	21
	290	29,5	31	250	36,4	26
	390	39,7	41	290	42,2	31
	<b>483</b>	<b>49,2</b>	51	<b>338</b>	<b>49,1</b>	36
φ14	210	24,9	25	210	35,6	25
	330	39,2	40	270	45,8	33
	450	53,4	54	330	56,0	40
	<b>564</b>	<b>67,0</b>	68	<b>394</b>	<b>66,8</b>	48
φ16	240	32,6	33	240	46,5	33
	370	50,2	50	310	60,1	42
	510	69,2	69	380	73,7	52
	<b>644</b>	<b>87,4</b>	87	<b>451</b>	<b>87,4</b>	61
φ18	270	41,2	41	270	58,9	41
	410	62,6	62	350	76,3	53
	560	85,5	84	430	93,8	65
	<b>700</b>	<b>106,9</b>	106	<b>507</b>	<b>110,6</b>	76
φ20	300	50,9	64	300	72,7	64
	430	72,9	91	390	94,5	83
	570	96,7	121	480	116,3	102
	<b>700</b>	<b>118,8</b>	148	<b>564</b>	<b>136,7</b>	120
φ22	330	61,6	93	330	88,0	93
	450	84,0	127	430	114,6	122
	580	108,2	164	520	138,6	147
	<b>700</b>	<b>130,6</b>	198	<b>620</b>	<b>165,3</b>	175
φ24	360	73,3	152	360	104,7	152
	470	95,7	198	470	136,7	198
	590	120,1	249	570	165,8	241



**Pre-calculated values<sup>1)</sup> – overlap length**

 Rebar yield strength  $f_{yk}=500 \text{ N/mm}^2$ , concrete C25/30, good bond conditions

Rebar [mm]	Overlap length $l_0$ [mm]	Design value $N_{Rd}$ [kN]	Mortar volume <sup>2)</sup> $V_M$ [ml]	Overlap length $l_0$ [mm]	Design value $N_{Rd}$ [kN]	Mortar volume <sup>2)</sup> $V_M$ [ml]
	$\alpha_1=\alpha_2=\alpha_3=\alpha_4=\alpha_5=1,0$			$\alpha_1 = \alpha_3 = \alpha_4 = 1,0 \quad \alpha_2 \text{ or } \alpha_5 = 0,7$		
$\phi 25$	<b>700</b>	<b>142,5</b>	296	<b>676</b>	<b>196,6</b>	285
	375	79,5	141	375	113,6	141
	480	101,8	181	480	145,4	181
	590	125,1	222	590	178,7	222
	<b>700</b>	<b>148,4</b>	263	<b>700</b>	<b>212,1</b>	263

- 1) Values corresponding to the minimum anchorage length. The maximum permissible load is valid for “good bond conditions” as described in EN 1992-1-1. For all other conditions multiply by the value by 0,7.
- 2) The volume of mortar corresponds to the formula “ $1,2 \cdot (d_0^2 - d_s^2) \cdot \pi \cdot l_b / 4$ ” for hammer drilling

**Materials**
**Material quality**

Part	Material
Rebar EN 1992-1-1	Bars and de-coiled rods class B or C with $f_{yk}$ and $k$ according to NDP or NCL of EN 1992-1-1 $f_{uk} = f_{tk} = k \cdot f_{yk}$

**Fitness for use**

Some creep tests have been conducted in accordance with ETAG guideline 001 part 5 and TR 023 in the following conditions: **in dry environment at 50 °C during 90 days.**

These tests show an excellent behaviour of the post-installed connection made with HIT-HY 170: low displacements with long term stability, failure load after exposure above reference load.

**Resistance to chemical substance**

Chemical substance	Comment	Resistance
Sulphuric acid	23°C	+
Alkaline medium	pH = 13,2, 23°C	+

## Setting information

### Installation temperature range

-5°C to +40°C

### Service temperature range

Hilti HIT-HY 170 injection mortar may be applied in the temperature ranges given below. An elevated base material temperature may lead to a reduction of the design bond resistance.

Temperature range	Base material temperature	Maximum long term base material temperature	Maximum short term base material temperature
Temperature range I	-40 °C to +80 °C	+50 °C	+80 °C

### Maximum short term base material temperature

Short-term elevated base material temperatures are those that occur over brief intervals, e.g. as a result of diurnal cycling.

### Maximum long term base material temperature

Long-term elevated base material temperatures are roughly constant over significant periods of time.

### Working time and curing time

Temperature of the base material	Maximum working time	Minimum curing time
$T_{BM}$	$t_{work}$	$t_{cure}^{1)}$
$-5\text{ °C} \leq T_{BM} \leq 0\text{ °C}^a)$	10 min	12 hours
$0\text{ °C} \leq T_{BM} \leq 5\text{ °C}^a)$	10 min	5 hours
$5\text{ °C} \leq T_{BM} \leq 10\text{ °C}$	8 min	2,5 hours
$10\text{ °C} \leq T_{BM} \leq 20\text{ °C}$	5 min	1,5 hours
$20\text{ °C} \leq T_{BM} \leq 30\text{ °C}$	3 min	45 min
$30\text{ °C} \leq T_{BM} \leq 40\text{ °C}$	2 min	30 min

1) The curing time data are valid for dry base material only. In wet base material the curing times must be doubled.

### Installation equipment

Rebar – size	$\phi 8$	$\phi 10$	$\phi 12$	$\phi 14$	$\phi 16$	$\phi 18$	$\phi 20$	$\phi 22$	$\phi 24$	$\phi 25$
Rotary hammer	TE2(-A) – TE30(-A)					TE40 – TE80				
Other tools	Blow out pump ( $h_{ef} \leq 10 \cdot d$ )					-				
	Compressed air gun <sup>a)</sup> Set of cleaning brushes <sup>b)</sup> , dispenser, piston plug									

a) Compressed air gun with extension hose for all drill holes deeper than 250 mm (for  $\phi 8$  to  $\phi 12$ ) or deeper than  $20 \cdot \phi$  (for  $\phi > 12$  mm)

b) Automatic brushing with round brush for all drill holes deeper than 250 mm (for  $\phi 8$  to  $\phi 12$ ) or deeper than  $20 \cdot \phi$  (for  $\phi > 12$  mm)

### Minimum concrete cover $c_{min}$ of the post-installed rebar

Drilling method	Bar diameter [mm]	Minimum concrete cover $c_{min}$ [mm]	
		Without drilling aid	With drilling aid
Hammer drilling (HD)	$\phi < 25$	$30 + 0,06 \cdot l_v \geq 2 \cdot \phi$	$30 + 0,02 \cdot l_v \geq 2 \cdot \phi$
	$\phi \geq 25$	$40 + 0,06 \cdot l_v \geq 2 \cdot \phi$	$40 + 0,02 \cdot l_v \geq 2 \cdot \phi$
Compressed air drilling (CA)	$\phi < 25$	$50 + 0,08 \cdot l_v$	$50 + 0,02 \cdot l_v$
	$\phi \geq 25$	$60 + 0,08 \cdot l_v \geq 2 \cdot \phi$	$60 + 0,02 \cdot l_v \geq 2 \cdot \phi$

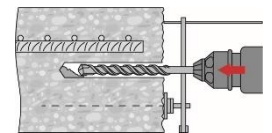

**Drilling and cleaning parameters**

Rebar	Drilling			Cleaning		Installation
	Hammer drilling (HD)	Hollow Drill Bit (HDB)	Compressed air drilling (CA)	Brush HIT-RB	Air nozzle HIT-RB	Piston plug HIT-SZ
	d <sub>0</sub> [mm]			size [mm]		
φ8	10 <sup>a)</sup>	10 <sup>a)</sup>	-	10	10	10
	12	12	-	12	12	12
φ10	12 <sup>a)</sup>	12 <sup>a)</sup>	-	12	12	12
	14	14	-	14	14	14
φ12	14 <sup>a)</sup>	14 <sup>a)</sup>	-	14	14	14
	16	16	-	16	16	16
	-	-	17	18	16	16
φ14	18	18	-	18	18	18
	-	-	17	18	16	16
φ16	20	20	20	20	20	20
φ18	22	22	22	22	22	22
φ20	25	25	-	25	25	25
	-	-	26	28	25	25
φ22	28	28	28	28	28	28
φ24	32	32	32	32	32	32
φ25	32	32	32	32	32	32

a) Maximum installation length l=250 mm.

**Dispensers and corresponding maximum embedment depth  $l_{v,max}$** 

Rebar	Dispenser HDM 330, HDM 500, HDE 500
	$l_{v,max}$ [mm]
φ8 to φ16	1000
φ18 to φ25	700

## Setting instructions

\*For detailed information on installation see instruction for use given with the package of the product.



### Safety regulations.

Review the Material Safety Data Sheet (MSDS) before use for proper and safe handling! Wear well-fitting protective goggles and protective gloves when working with Hilti HIT-HY 170.

## Drilling

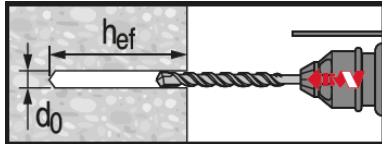

### Hammer drilled hole

For dry and wet concrete.

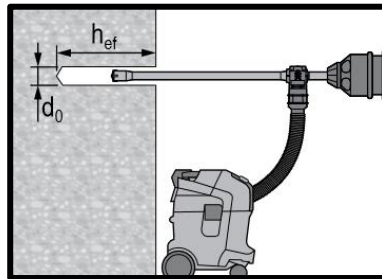

### Hammer drilled hole with Hollow Drilled Bit (HDB)

No cleaning required.

## Cleaning

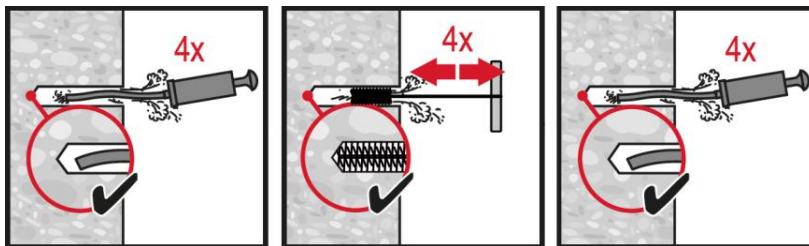

### Manual cleaning (MC)

for drill diameters  $d_0 \leq 20$  mm and drill hole depth  $h_0 \leq 10 \cdot d$ .

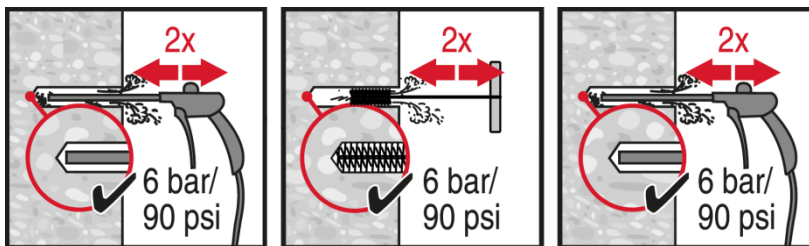

### Compressed air cleaning (CAC)

for all drill hole diameters  $d_0$  and drill hole depths  $h_0 \leq 20 \cdot d$ .

## Injection system

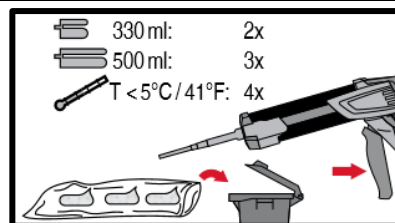
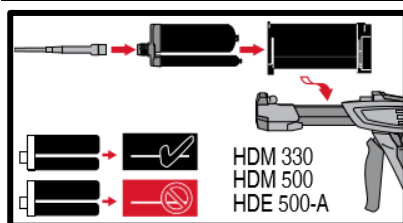

### Injection system preparation.

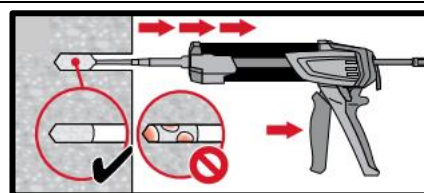
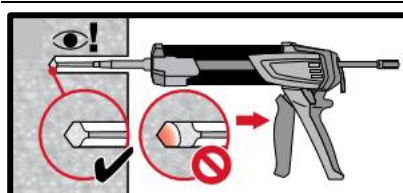

### Injection method for drill hole depth $h_{ef} \leq 250$ mm.

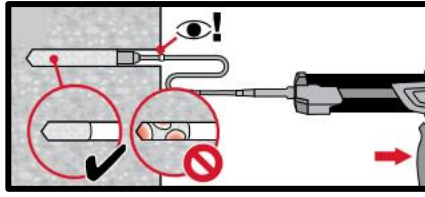
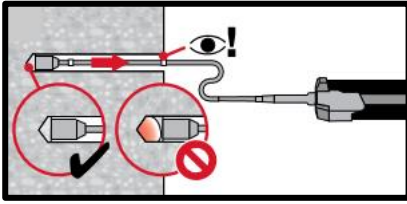

**Injection method for drill hole depth  $h_{ef} > 250\text{mm}$ .**

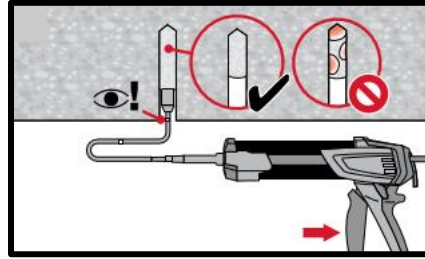
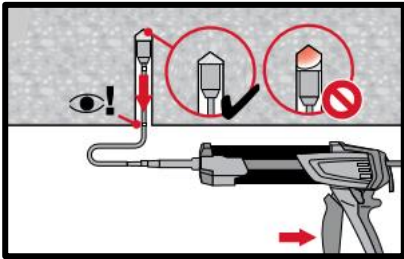

**Injection method for overhead application.**

**Setting the element**

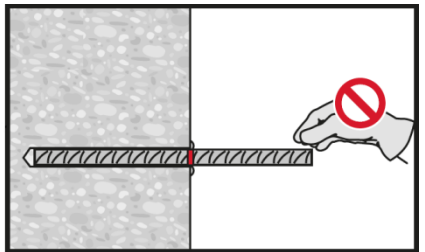
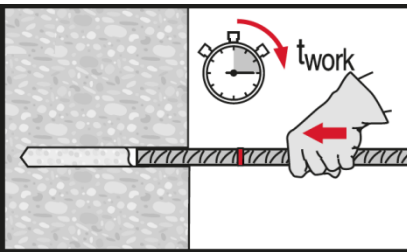

**Setting element, observe working time "t<sub>work</sub>".**

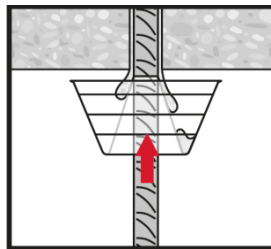
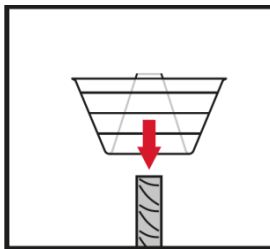
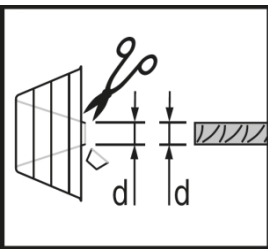

**Setting element for overhead applications, observe working time "t<sub>work</sub>".**

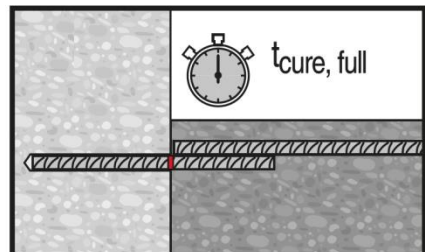
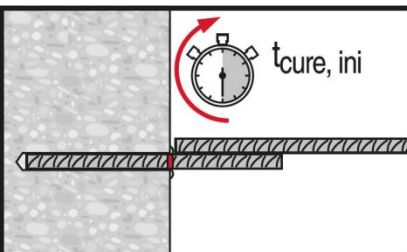
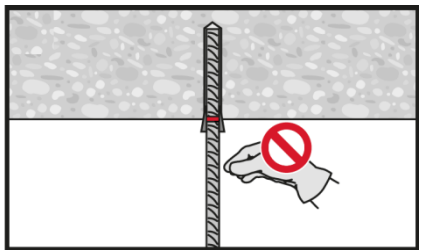
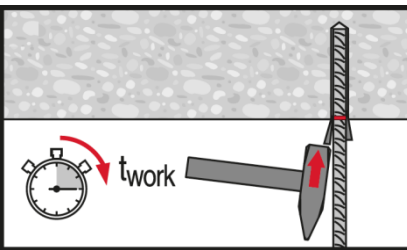

**Apply full load only after curing time "t<sub>cure</sub>".**

## 2.2.2 HIT-MM Plus

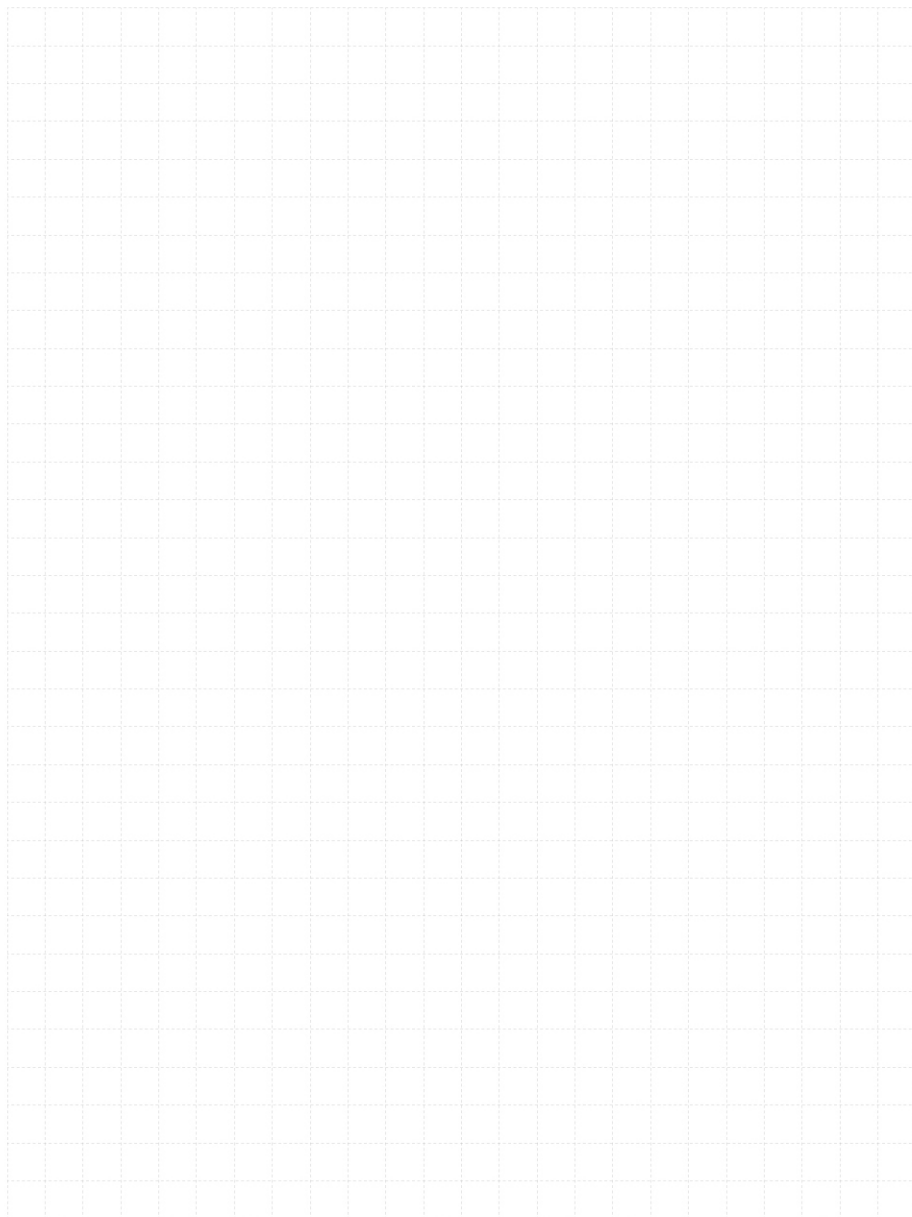

# HIT-MM Plus injection mortar

Anchor design (EN 1992-4) / Rods and Sleeves / Concrete

## Injection mortar system



Hilti HIT-MM Plus  
300 ml foil pack  
(also available as  
500 ml foil pack)

## Benefits

- Chemical injection fastening
- Two component hybrid mortar
- Rapid curing
- Suitable for overhead fastenings
- Versatile and conventional handling
- Clean and simple in use
- Small edge distance and anchor spacing
- Always correct mixing ratio



Anchor rods:  
HAS-U  
HAS-U HDG  
HAS-U A4  
HAS-U HCR  
(M8-M16)



Internally threaded sleeves:  
HIS-N  
(M8-M16)

## Base material



Concrete  
(non-cracked)



Dry concrete

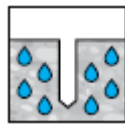

Wet concrete

## Load conditions

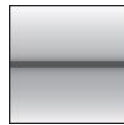

Static/  
quasi-static

## Installation conditions



Hammer  
drilling

## Other information

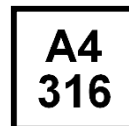

Corrosion  
resistance



European  
Technical  
Assessment

## Approvals / certificates

Description	Authority / Laboratory	No. / date of issue
European Technical Assessment <sup>a)</sup>	DIBt, Berlin	ETA-17/0199 / 2019-08-30
Hilti Technical Data <sup>b)</sup>	Hilti	2019-09-23

a) All data given in this section according to ETA 17/0199 (issued 2019-08-30).

b) All data given in this section according to Hilti Technical Data.

## Static and quasi-static loading (for a single anchor)

### Data in this section applies to:

- Correct setting (See setting instruction)
- No edge distance and spacing influence
- Steel failure
- Base material thickness, as specified in the table
- Embedment depth, as specified in the table
- Concrete C 20/25,  $f_{ck,cube} = 25 \text{ N/mm}^2$
- In-service temperate range I  
(min. base material temperature  $-40^\circ\text{C}$ , max. long term/short term base material temperature:  $+24^\circ\text{C}/40^\circ\text{C}$ )

### Embedment depth <sup>a)</sup> and base material thickness

Anchor size			M8			M10			M12			M16		
Embedment depth <sup>b)</sup>	$h_{ef}$	[mm]	60	80	160	60	100	200	70	120	240	80	160	320
Base material thickness	$h$	[mm]	100	110	190	100	130	210	100	150	270	116	196	356

a) The allowed range of embedment depth is shown in the setting details

b) Recommended loads calculated for embedment depths  $h_{ef} = h_{ef,min}$ ;  $h_{ef} = 10d$ ;  $h_{ef} = h_{ef,max} = 20d$

### Recommended loads <sup>a)</sup>

Anchor size				M8			M10			M12			M16		
<b>Non-cracked concrete</b>															
Tension	HAS-U 5.8	$N_{rec}$	[kN]	5,4	7,2	8,7	6,7	11,2	13,8	9,4	16,1	20,1	14,4	28,7	37,4
Shear	HAS-U 5.8	$V_{rec}$	[kN]	5,2			8,3			12,0			22,4		

a) The data provided in the table is intended for product comparison only and not suitable for the complete design of an anchorage.

Watch out! Data for M20 and M24 was excluded from the table

Watch out! Data for HIS-N was not in FTM



**Materials**
**Mechanical properties for HAS-U**

Anchor size		M8	M10	M12	M16	
Nominal tensile strength	HAS-U 5.8	500	500	500	500	
	HAS-U 8.8	800	800	800	800	
	HAS-U-R	700	700	700	700	
	HAS-U-HCR	800	800	800	800	
Yield strength	HAS-U 5.8	400	400	400	400	
	HAS-U 8.8	640	640	640	640	
	HAS-U-R	450	450	450	450	
	HAS-U-HCR	640	640	640	640	
Stressed cross-section	HAS-U	$A_s$ [mm <sup>2</sup> ]	36,6	58,0	84,3	157
Moment of resistance	HAS-U	$W$ [mm <sup>3</sup> ]	31,2	62,3	109	277

**Material quality for HAS-U**

Part	Material
<b>Zinc coated steel</b>	
Threaded rod, HAS-U 5.8 (HDG)	Strength class 5.8; Elongation at fracture A5 > 8% ductile Electroplated zinc coated $\geq 5\mu\text{m}$ ; (HDG) hot dip galvanized $\geq 45\mu\text{m}$
Threaded rod, HAS-U 8.8 (HDG)	Strength class 8.8; Elongation at fracture A5 > 12% ductile Electroplated zinc coated $\geq 5\mu\text{m}$ ; (HDG) hot dip galvanized $\geq 45\mu\text{m}$
Washer	Electroplated zinc coated $\geq 5\mu\text{m}$ , hot dip galvanized $\geq 45\mu\text{m}$
Nut	Strength class of nut adapted to strength class of threaded rod. Electroplated zinc coated $\geq 5\mu\text{m}$ , hot dip galvanized $\geq 45\mu\text{m}$
<b>Stainless Steel</b>	
Threaded rod, HAS-U A4	Strength class 70 for M8-M16 Elongation at fracture A5 > 8% ductile Stainless steel 1.4401; 1.4404; 1.4578; 1.4571; 1.4439; 1.4362
Washer	Stainless steel 1.4401, 1.4404, 1.4578, 1.4571, 1.4439, 1.4362 EN 10088-1:2014
Nut	Stainless steel 1.4401, 1.4404, 1.4578, 1.4571, 1.4439, 1.4362 EN 10088-1:2014
<b>High corrosion resistant steel</b>	
Threaded rod, HAS-U HCR	Strength class 80 for M8-M16 Elongation at fracture A5 > 8% ductile High corrosion resistance steel 1.4529; 1.4565;
Washer	High corrosion resistant steel 1.4529, 1.4565 EN 10088-1:2014
Nut	High corrosion resistant steel 1.4529, 1.4565 EN 10088-1:2014

**Mechanical properties for HIS-N**

Anchor size				M8	M10	M12	M16
Nominal tensile strength	HIS-N	$f_{uk}$	[N/mm <sup>2</sup> ]	490	490	460	460
	Screw 8.8			800	800	800	800
	HIS-RN			700	700	700	700
	Screw A4-70			700	700	700	700
Yield strength	HIS-N	$f_{yk}$	[N/mm <sup>2</sup> ]	410	410	375	375
	Screw 8.8			640	640	640	640
	HIS-RN			350	350	350	350
	Screw A4-70			450	450	450	450
Stressed cross-section	HIS-(R)N	$A_s$	[mm <sup>2</sup> ]	51,5	108	169	256
	Screw			36,6	58	84,3	157
Moment of resistance	HIS-(R)N	$W$	[mm <sup>3</sup> ]	145	430	840	1595
	Screw			31,2	62,3	109	277

**Material quality for HIS-N**

Part		Material
HIS-N	Internal threaded sleeve	C-steel 1.0718; Steel galvanized $\geq 5 \mu\text{m}$
	Screw 8.8	Strength class 8.8, A5 > 8 % Ductile; Steel galvanized $\geq 5 \mu\text{m}$
HIS-RN	Internal threaded sleeve	Stainless steel 1.4401, 1.4571
	Screw 70	Strength class 70, A5 > 8 % Ductile Stainless steel 1.4401; 1.4404, 1.4578; 1.4571; 1.4439; 1.4362

## Setting information

### Installation temperature range:

-5°C to +40°C

### In service temperature range

Hilti HIT MM Plus injection mortar with anchor rods may be applied in the temperature ranges given below. An elevated base material temperature leads to a reduction of the design bond resistance.

Temperature range	Base material temperature	Maximum long term base material temperature	Maximum short term base material temperature
Temperature range	-40 °C to + 40 °C	+ 24 °C	+ 40 °C

### Maximum short term base material temperature

Short term elevated base material temperatures are those that occur over brief intervals, e.g. as a result of diurnal cycling.

### Maximum long term base material temperature

Long term elevated base material temperatures are roughly constant over significant periods of time.

### Working time and curing time <sup>a)</sup>

Temperature of the base material	Maximum working time	Minimum curing time
$T_{BM}$	$t_{work}$	$t_{cure}^{a)}$
$-5\text{ °C} < T_{BM} \leq 0\text{ °C}$	10 min	12 h
$0\text{ °C} < T_{BM} \leq 5\text{ °C}$	10 min	5 h
$5\text{ °C} < T_{BM} \leq 10\text{ °C}$	8 min	2,5 h
$10\text{ °C} < T_{BM} \leq 20\text{ °C}$	5 min	1,5 h
$20\text{ °C} < T_{BM} \leq 30\text{ °C}$	3 min	45 min
$30\text{ °C} < T_{BM} \leq 40\text{ °C}$	2 min	30 min

a) The curing time data are valid for dry base material only. In wet base material, the curing times must be doubled.

**Setting details for HAS-U**

Anchor size			M8	M10	M12	M16
Nominal diameter of element	d	[mm]	8	10	12	16
Nominal diameter of drill bit	d <sub>0</sub>	[mm]	10	12	14	18
Maximum diameter of clearance hole in the fixture	d <sub>f</sub>	[mm]	9	12	14	18
Effective anchorage depth (= drill hole depth)	h <sub>ef,min</sub> = h <sub>0</sub>	[mm]	60	60	70	80
	h <sub>ef,max</sub> = h <sub>0</sub>	[mm]	160	200	240	320
Minimum base material thickness	h <sub>min</sub>	[mm]	h <sub>ef</sub> + 30 mm ≥ 100 mm			h <sub>ef</sub> + 2d <sub>0</sub>
Maximum torque moment	T <sub>max</sub>		10	20	40	80
Minimum spacing	s <sub>min</sub>	[mm]	40	50	60	80
Minimum edge distance	c <sub>min</sub>	[mm]	40	50	60	80

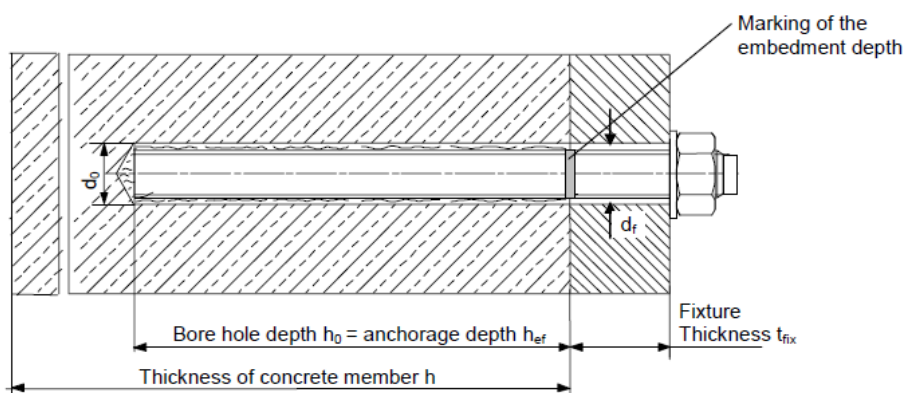
**Setting details for HIS-N**



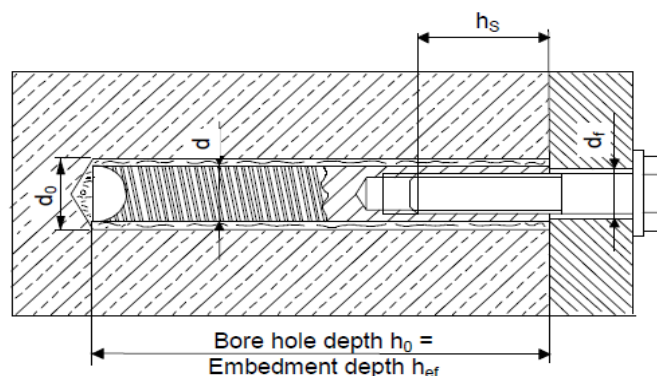

Anchor size			M8	M10	M12	M16
Diameter of element	d	[mm]	12,5	16,5	20,5	25,4
Nominal diameter of drill bit	d <sub>0</sub>	[mm]	14	18	22	28
Maximum diameter of clearance hole in the fixture	d <sub>f</sub>	[mm]	9	12	14	18
Effective anchorage depth	h <sub>ef</sub>	[mm]	90	110	125	170
Minimum base material thickness	h <sub>min</sub>	[mm]	120	146	169	226
Thread engagement length; min – max	h <sub>s</sub>	[mm]	8-20	10-25	12-30	16-40
Maximum torque moment	T <sub>max</sub>	[Nm]	10	20	40	80
Minimum spacing	s <sub>min</sub>	[mm]	60	75	90	115
Minimum edge distance	c <sub>min</sub>	[mm]	40	45	55	65



**Installation equipment**

Anchor size	M8	M10	M12	M16
Rotary hammer	TE2 – TE16			
Other tools	blow out pump ( $h_{ef} \leq 10 \cdot d$ ), Compressed air gun, set of cleaning brushes, dispenser			

**Parameters of cleaning and setting tools**

HAS-U	HIS-N	Drilling and cleaning		Installation
		Hammer drill	Brush HIT-RB	Piston plug HIT-SZ
		$d_0$ [mm]	size [mm]	
				
<b>M8</b>	-	10	10	-
<b>M10</b>	-	12	12	12
<b>M12</b>	<b>M8</b>	14	14	14
<b>M16</b>	<b>M10</b>	18	18	18
-	<b>M12</b>	22	22	22
-	<b>M16</b>	28	28	28

## Setting instructions

\*For detailed information on installation see instruction for use given with the package of the product.



### Safety regulations.

Review the Material Safety Data Sheet (MSDS) before use for proper and safe handling! Wear well-fitting protective goggles and protective gloves when working with Hilti HIT-MM Plus.

### Drilling

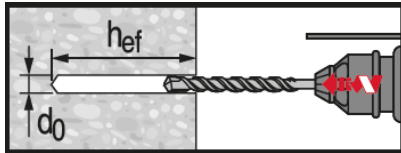

**Hammer drilled hole (HD)**

### Cleaning

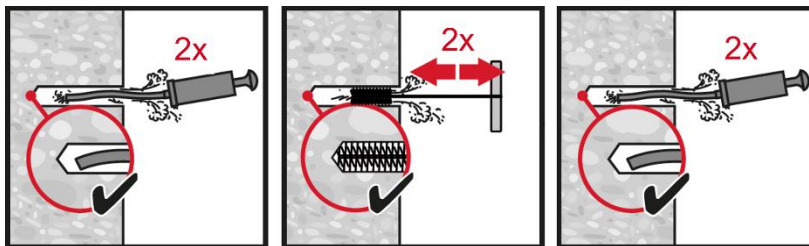

**Manual cleaning (MC)  
Non-cracked concrete only**

for drill diameters  $d_0 \leq 18$  mm and drill hole depth  $h_0 \leq 10 \cdot d_0$ .

### Injection system

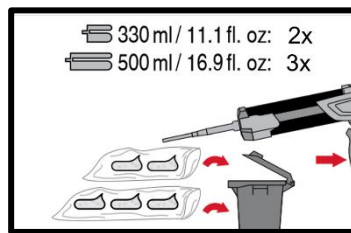
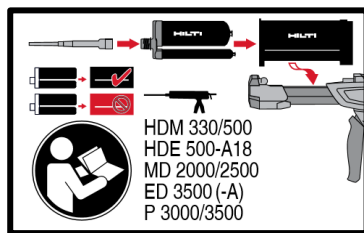

**Injection system preparation.**

### Injection system

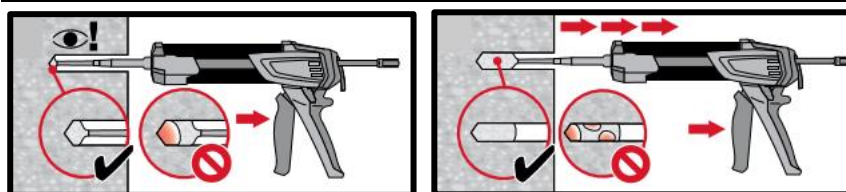

**Injection method for drill hole depth**  
 $h_{ef} \leq 250$  mm.

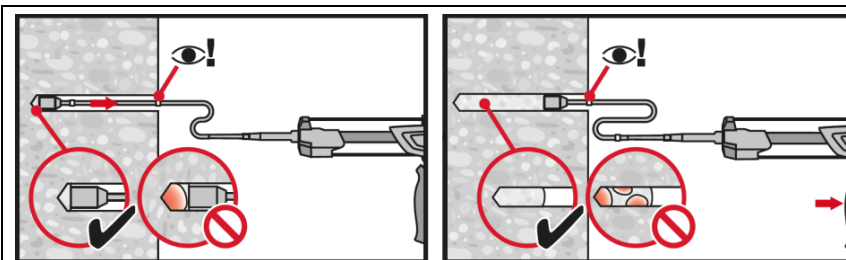

**Injection method for drill hole depth**  
 $h_{ef} > 250$  mm.

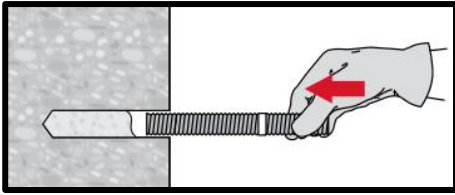
**Setting the element**

**Setting element**, observe working time " $t_{work}$ ",

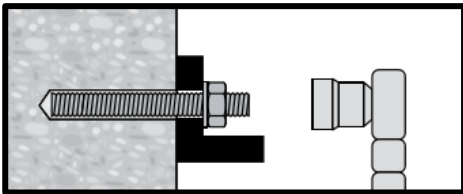

**Loading the anchor** after required curing time  $t_{cure}$  the anchor can be loaded. The applied installation torque shall not exceed  $T_{max}$ .

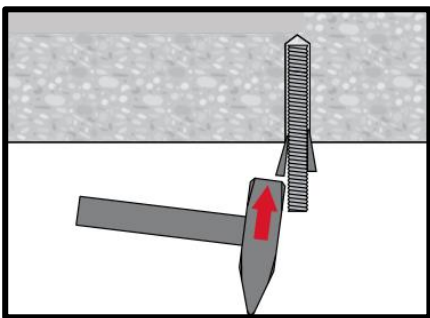

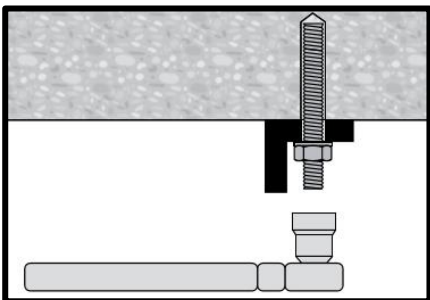

**Setting element** for overhead applications, observe working time " $t_{work}$ "







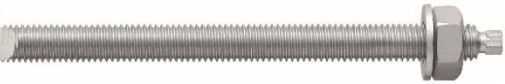

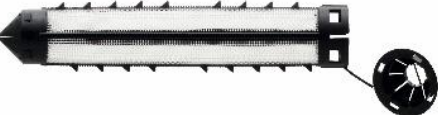
**Loading the anchor** after required curing time  $t_{cure}$  the anchor can be loaded. The applied installation torque shall not exceed  $T_{max}$ .

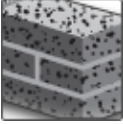
# HIT-MM Plus injection mortar

## Anchor design (EOTA TR 054) / Rods and Sleeves / Masonry

Injection mortar system		Benefits
	Hilti HIT-MM Plus 300 ml foil pack (also available as 500 ml foil pack)	<ul style="list-style-type: none"> <li>- Chemical injection fastening for all type of base materials:</li> <li>- Hollos and solid clay bricks, sand-lime bricks, normal and light weight concrete blocks, aereated light weight concrete, natural stones</li> <li>- Two component hybrid mortar</li> <li>- Rapid curing</li> <li>- Flexible setting depth and fastening thickness</li> <li>- Suitable for overhead fastenings</li> <li>- Versatile and conventional handling</li> <li>- Clean and simple in use</li> <li>- Small edge distance and anchor spacing</li> <li>- Always correct mixing ratio</li> </ul>
	Anchor rods: HAS-U HAS-U HDG HAS-U A4 HAS-U HCR (M8-M12)	
	Anchor rods: HIT-IC (M8-M12)	
	Sieve sleeves: HIT-SC (16-22)	

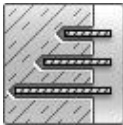
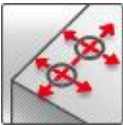
Base material	Load conditions
<div style="display: flex; justify-content: space-around;"> <div data-bbox="137 1205 260 1328">  <p>Solid brick</p> </div> <div data-bbox="304 1205 427 1328">  <p>Hollow brick</p> </div> </div>	<div style="display: flex; justify-content: center; align-items: center;">  <p>Static/ quasi-static</p> </div>

Installation conditions	Other information
<div style="display: flex; justify-content: space-around;"> <div data-bbox="137 1476 260 1599">  <p>Hammer / rotary drilling</p> </div> <div data-bbox="304 1476 427 1599">  <p>Variable embedment depth</p> </div> <div data-bbox="483 1476 606 1599">  <p>Small edge distance and spacing</p> </div> </div>	<div style="display: flex; justify-content: space-around; align-items: center;"> <div data-bbox="839 1476 962 1599" style="border: 2px solid black; padding: 5px;"> <p style="font-size: 24px; margin: 0;"><b>A4</b></p> <p style="font-size: 24px; margin: 0;"><b>316</b></p> </div> <div data-bbox="1010 1498 1133 1576">  </div> </div> <p style="text-align: center;">Corrosion resistance</p> <p style="text-align: center;">European Technical Approval</p>

### Approvals / certificates

Description	Authority / Laboratory	No. / date of issue
European Technical Assessment <sup>a)</sup>	DIBt, Berlin	ETA-16/0239 / 2019-08-30

c) All data given in this section according to ETA-16/0239 (issued 2019-08-30).



## Brick types and properties

### Instruction to this technical data

- Identify/choose your brick (or brick type) and its geometrical/physical properties on the following tables. Information about edge and spacing criteria is available on the following pages.
  - The pages referred on the last column of the table below contain the design resistance loads for pull-out failure of the anchor, brick breakout failure and local brick failure for each respective brick. Notice that the data displayed on these tables is only valid for single anchors with distance to edge such that loading capacity is not influenced by it – for other cases not covered, consult ETA-16/0239 or contact Hilti Engineering Team.
- The resistance loads provided by this technical data manual are valid only for exact same masonry unit (hollow bricks) or for units made of the same base material with equal or higher size and compressive strength (solid bricks). For other cases, on-site tests must be performed

### Exterior brick dimensions

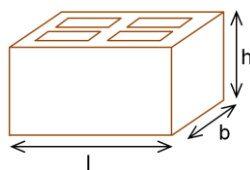

Generic bricks

### Interior dimensions of the majority of the holes

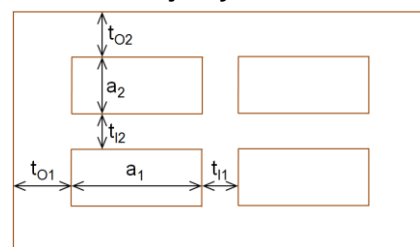

### Brick types and properties

Brick code	Data	Brick name	Image	Size [mm]	$t_0$ [mm]	$t_1$ [mm]	$a$ [mm]	$f_b$ [N/mm <sup>2</sup> ]	$\rho$ [kg/dm <sup>3</sup> ]
<b>Solid clay</b>									
SC3	ETA	Solid clay brick Mz, 2DF		l: $\geq 240$ b: $\geq 115$ h: $\geq 113$	-	-	-	12	2,0
<b>Solid Calcium Silicate</b>									
SCS1	ETA	Solid silica brick KS, 2DF		l: $\geq 240$ b: $\geq 115$ h: $\geq 113$	-	-	-	12 28	2,0
<b>Hollow clay</b>									
HC1	ETA	Hollow clay brick Hlz, 10DF		l: 300 b: 240 h: 238	$t_{01}$ : 12 $t_{02}$ : 15	$t_{11}$ : 11 $t_{12}$ : 15	$a_1$ : 10 $a_2$ : 25	12 20	1,4
<b>Hollow Calcium Silicate</b>									
HCS1	ETA	Hollow silica brick KSL, 8DF		l: 248 b: 240 h: 238	$t_{01}$ : 34 $t_{02}$ : 22	$t_{11}$ : 11 $t_{12}$ : 20	$a_1$ : 52 $a_2$ : 52	12 20	1,4

## Anchor installation parameters

### Brick position:

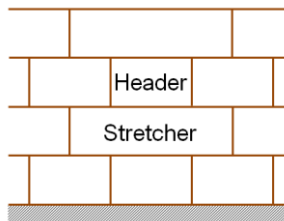

- **Header (H):** The longest dimension of the brick represents the width of the wall
- **Stretcher (S):** The longest dimension of the brick represents the length of the wall

### Spacing and edge distance:

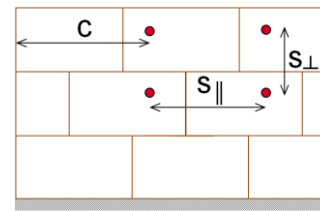

- $c$  - Distance to the edge
- $s_{||}$  - Spacing parallel to the bed joint
- $s_{\perp}$  - Spacing perpendicular to the bed joint

### Allowed anchor positions:

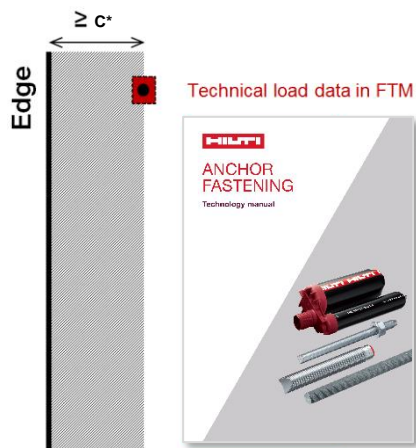

- This FTM includes the load data for single anchors in masonry with a distance to edge equal to or greater than  $c^*$ .
- $c^*$  is the distance from the anchor to the edge of the wall, such that the loading capacity of the anchor is not influenced by the edge.
- Minimum spacing between anchors = MAX ( $3 \times h_{ef}$ ; size of brick in respective direction). This applies for a (conservative) manual design/calculation of a baseplate using the load tables in this manual.
- For an optimized design or cases not covered in this technical data, including anchor groups, please consult ETA-16/0239.

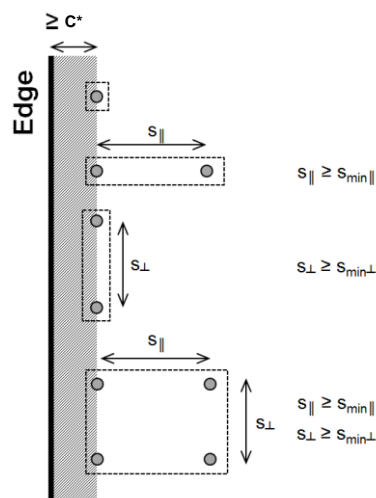

### Static and quasi-static loading (for a single anchor)

#### All data in this section applies to:

- Correct anchor setting (see instruction for use, setting details)
- Steel quality for screws for HIT-IC: minimum grade 5.8
- Anchorages are designed under the responsibility of an engineer experienced in anchorages and masonry work.
- Verifiable calculation notes and drawings are prepared taking account of the loads to be anchored. The position of the anchor is indicated on the design drawings (e.g. position of the anchor relative to supports, etc.).
- Anchorages under static or quasi-static loading are designed in accordance with: EOTA TR054, Design method A

#### Basic loading data (for a single anchor)

The load tables provide the design resistance values for a single loaded anchor.





#### All data in this section applies to

- Edge distance  $c \geq c^*$ . For other applications, please consult ETA-16/0239.
- Correct anchor setting (see instruction for use, setting details)

Anchorages subject to:		Hilti HIT-MM Plus with HAS-U or HIT-IC	
		in solid bricks	in hollow bricks
Hole drilling		hammer mode	rotary mode
Use category: dry or wet structure		Category <b>d/d</b> - <b>Installation and use</b> in structures subject to <b>dry</b> , internal conditions, Category <b>w/d</b> - <b>Installation</b> in dry or <b>wet</b> substrate and <b>use</b> in structures subject to <b>dry</b> , internal conditions (except calcium silicate bricks), Category <b>w/w</b> - <b>Installation and use</b> in structures subject to dry or <b>wet</b> environmental conditions (except calcium silicate bricks).	
Installation direction	Masonry	horizontal	
Temperature in the base material at installation		+5° C to +40° C	0° C to +40° C
In-service temperature	Temperature range Ta:	-40 °C to +40 °C	(max. long term temperature +24 °C and max. short term temperature +40 °C)
	Temperature range Tb:	-40 °C to +80 °C	(max. long term temperature +50 °C and max. short term temperature +80 °C)

**Due to the wide variety of bricks site tests have to be performed for determination of load values for all applications outside of the above mentioned base materials and / or setting conditions.**

**Design tension resistances – Pull-out failure of the anchor, brick breakout failure and local brick failure at edge distance ( $c \geq c^*$ ) for single anchor applications**

Load type	Anchor size	$h_{ef}$ [mm]	$f_b$ [N/mm <sup>2</sup> ]	w/w and w/d		d/d		
				Ta	Tb	Ta	Tb	
Loads [kN]								
 <b>SC3 – Solid clay brick</b> Mz, 1DF (ETA data)								
$N_{Rd,p} = N_{Rd,b}$ ( $c \geq 115$ mm)	HAS-U	M8, M10, M12	80	12	1,0	0,8	1,0	0,8
	HIT-IC	M8	80	12	1,0	0,8	1,0	0,8
		M10, M12	80	12	1,4	1,2	1,4	1,2
	HIT-IC + HIT-SC	M8, M10, M12	80	12	1,4	1,2	1,4	1,2
 <b>SCS1 - Solid silica brick</b> KS, 2DF (ETA data)								
$N_{Rd,p} = N_{Rd,b}$ ( $c \geq 115$ mm)	HAS-U, HIT-IC	M8, M10, M12	80	12	1,8	1,6	2,0	1,6
				28	2,8	2,4	2,8	2,4
	HAS-U + HIT-SC, HIT-ICE + HIT-SC	M8, M10, M12	80	12	1,4	1,0	1,8	1,6
				28	2,0	1,8	2,6	2,4
 <b>HC1 - Hollow clay brick</b> Hiz, 10DF (ETA data)								
$N_{Rd,p} = N_{Rd,b}$ ( $c \geq 150$ mm)	HAS-U + HIT-SC, HIT-IC + HIT-SC	M8, M10, M12	80	12	1,0	0,8	1,0	0,8
				20	1,2	1,0	1,2	1,0
 <b>HCS1 - Hollow silica brick</b> KSL, 8DF (ETA data)								
$N_{Rd,p} = N_{Rd,b}$ ( $c \geq 125$ mm)	HAS-U + HIT-SC, HIT-IC + HIT-SC	M8, M10, M12	80	12	1,0	0,8	1,0	0,8
				20	1,4	1,2	1,4	1,2

## On-site tests



For other bricks in solid or hollow masonry, not covered by the Hilti HIT-MM Plus ETA or this technical data manual, the characteristic resistance may be determined by on-site tension tests (pull-out tests or proof-load tests), according to EOTA TR053.

For the evaluation of test results, the characteristic resistance may be obtained taking into account the  $\beta$  factor, which considers the different influences of the product.

The  $\beta$  factor for the brick types covered by the Hilti HIT-MM Plus ETA is provided on the following table:

Use categories		w/w and w/d		d/d	
Temperature range		Ta*	Tb*	Ta*	Tb*
Base material	Elements				
Solid clay brick EN 771-2	HAS-U or HIT-IC	0,94	0,81	0,94	0,81
	HAS-U + HIT-SC				
	HIT-IC + HIT-SC				
Solid calcium silicate brick EN 771-2	HAS-U or HIT-IC	0,93	0,82	0,94	0,82
	HAS-U + HIT-SC	0,66	0,60	0,88	0,80
	HIT-IC + HIT-SC				
Hollow clay brick EN 771-1	HAS-U + HIT-SC	0,94	0,81	0,94	0,81
	HIT-IC + HIT-SC				
Hollow calcium silicate brick EN 771-2	HAS-U + HIT-SC	0,66	0,60	0,99	0,80
	HIT-IC + HIT-SC				

\*Ta / Tb, w/w and d/d anchorage parameters, as defined on previous pages

Applying the  $\beta$  factor from the table above, the characteristic tension resistance  $N_{Rk}$  can be obtained. Characteristic shear resistance  $V_{Rk}$  can also be directly derived from  $N_{Rk}$ . For detailed procedure consult EOTA TR053.

**Materials**
**Mechanical properties for HAS-U**

Anchor size				M8	M10	M12
Nominal tensile strength	HAS-U 5.8	$f_{uk}$	[N/mm <sup>2</sup> ]	500	500	500
	HAS-U A4			700	700	700
Yield strength	HAS-U 5.8	$f_{yk}$	[N/mm <sup>2</sup> ]	400	400	400
	HAS-U A4			450	450	450
Stressed cross-section	HAS-U	$A_s$	[mm <sup>2</sup> ]	36,6	58,0	84,3
Moment of resistance	HAS-U	W	[mm <sup>3</sup> ]	31,2	62,3	109

**Material quality**

Part	Material
<b>Zinc coated steel</b>	
Threaded rod, HAS-U 5.8 (HDG)	Strength class 5.8; Elongation at fracture A5 > 8% ductile Electroplated zinc coated $\geq 5\mu\text{m}$ ; (HDG) hot dip galvanized $\geq 45\mu\text{m}$
Threaded rod, HAS-U 8.8 (HDG)	Strength class 8.8; Elongation at fracture A5 > 12% ductile Electroplated zinc coated $\geq 5\mu\text{m}$ ; (HDG) hot dip galvanized $\geq 45\mu\text{m}$
Washer	Electroplated zinc coated $\geq 5\mu\text{m}$ , hot dip galvanized $\geq 45\mu\text{m}$
Nut	Strength class of nut adapted to strength class of threaded rod. Electroplated zinc coated $\geq 5\mu\text{m}$ , hot dip galvanized $\geq 45\mu\text{m}$
HIT-IC sleeve	Carbon steel; galvanized to min. 5 $\mu\text{m}$
<b>Stainless Steel</b>	
Threaded rod, HAS-U A4	Strength class 70 for M8-M12 Elongation at fracture A5 > 8% ductile Stainless steel 1.4401; 1.4404; 1.4578; 1.4571; 1.4439; 1.4362
Washer	Stainless steel 1.4401, 1.4404, 1.4578, 1.4571, 1.4439, 1.4362 EN 10088-1:2014
Nut	Stainless steel 1.4401, 1.4404, 1.4578, 1.4571, 1.4439, 1.4362 EN 10088-1:2014
<b>High corrosion resistant steel</b>	
Threaded rod, HAS-U HCR	Strength class 80 for M8-M12 Elongation at fracture A5 > 8% ductile High corrosion resistance steel 1.4529; 1.4565;
Washer	High corrosion resistant steel 1.4529, 1.4565 EN 10088-1:2014
Nut	High corrosion resistant steel 1.4529, 1.4565 EN 10088-1:2014
<b>Sieve sleeve</b>	
HIT-SC sleeve	Frame: FPP 20T, Sieve: PA6,6 N500/200

## Setting information

### Installation temperature range:

Solid masonry: 5°C to +40°C

Hollow masonry: 0°C to +40°C

### In service temperature range

Hilti HIT-HY MM+ injection mortar with anchor rods may be applied in the temperature ranges given below. An elevated base material temperature leads to a reduction of the design bond resistance.

Temperature range	Base material temperature	Maximum long term base material temperature	Maximum short term base material temperature
Temperature range I	-40 °C to + 40 °C	+ 24 °C	+ 40 °C
Temperature range II	-40 °C to + 80 °C	+ 50 °C	+ 80 °C

### Maximum short term base material temperature

Short term elevated base material temperatures are those that occur over brief intervals, e.g. as a result of diurnal cycling.

### Maximum long term base material temperature

Long term elevated base material temperatures are roughly constant over significant periods of time.

### Working time and curing time<sup>b)</sup>

Temperature of the base material	Maximum working time	Minimum curing time
TBM	$t_{work}$	$t_{cure}^{b)}$
0 °C < $T_{BM}$ ≤ 5 °C <sup>a)</sup>	10 min <sup>a)</sup>	6 h <sup>a)</sup>
5 °C < $T_{BM}$ ≤ 10 °C	8 min	3 h
10 °C < $T_{BM}$ ≤ 20 °C	5 min	2 h
20°C < $T_{BM}$ ≤ 30 °C	3 min	60 min
30 °C < $T_{BM}$ ≤ 40 °C	2 min	45 min

a) For hollow bricks only;

b) The curing time data are valid for dry base material only. In wet base material the curing times must be doubled

**Setting details for solid bricks with HAS-U**

Anchor size		HAS-U		
		M8	M10	M12
Sieve sleeve	HIT-SC	-	-	-
Nominal diameter of drill bit	$d_0$ [mm]	10	12	14
Effective anchorage and drill hole depth	$h_{ef} = h_0$ [mm]	80	80	80
Minimum base material thickness	$h_{min}$ [mm]	115	115	115
Maximum diameter of clearance hole in the fixture	$d_f$ [mm]	9	12	14
Minimum spacing	$s_{min}$ [mm]	100	100	100
Minimum edge distance	$c_{min}$ [mm]	100	100	100
Maximum torque moment	$T_{max}$ [Nm]	5	8	10
Filing volume	[ml]	4	5	7

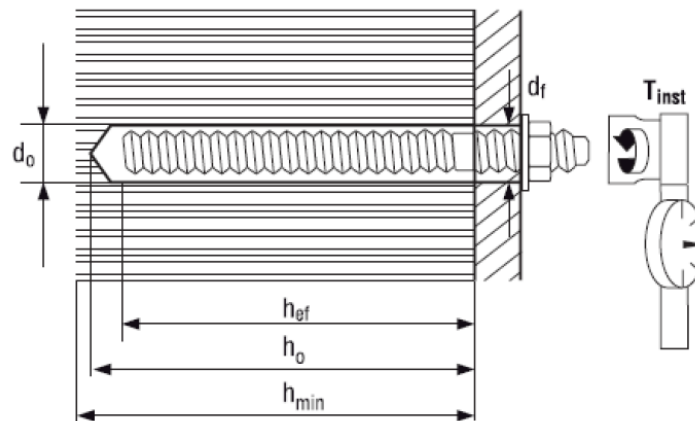
**Setting details for solid bricks with HIT-IC**

Anchor size		HIT-IC		
		M8	M10	M12
Sieve sleeve	HIT-SC	-	-	-
Nominal diameter of drill bit	$d_0$ [mm]	14	16	18
Effective anchorage and drill hole depth	$h_{ef} = h_0$ [mm]	80	80	80
Minimum base material thickness	$h_{min}$ [mm]	115	115	115
Maximum diameter of clearance hole in the fixture	$d_f$ [mm]	9	12	14
Length of bolt engagement	$h_s$ [mm]	8...75	10...75	12...75
Maximum torque moment	$T_{max}$ [Nm]	5	8	10
Filing volume	[ml]	6	6	6

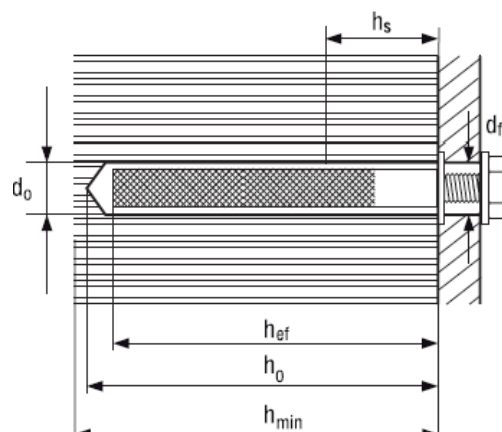



**Setting details for hollow bricks for HAS-U**



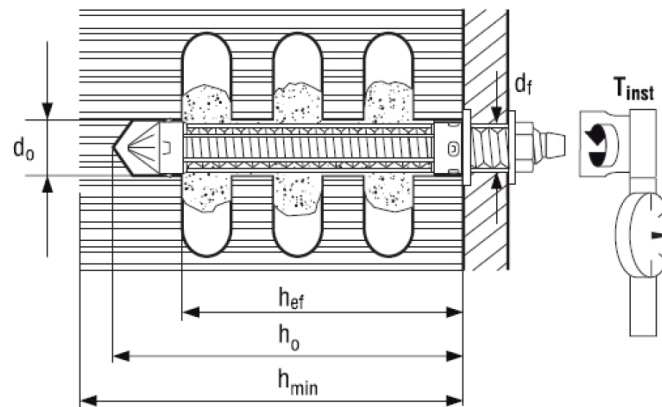

Anchor size		HAS-U + HIT-SC		
		M8	M10	M12
Sieve sleeve	HIT-SC	16x85	16x85	18x85
Nominal diameter of drill bit	$d_0$ [mm]	16	16	18
Effective anchorage depth	$h_{ef}$ [mm]	80	80	80
Drill hole depth	$h_0$ [mm]	95	95	95
Minimum base material thickness	$h_{min}$ [mm]	115	115	115
Maximum diameter of clearance hole in the fixture	$d_f$ [mm]	9	12	14
Torque moment	$T_{max}$ [Nm]	3	4	6
Filing volume	[ml]	30	30	36

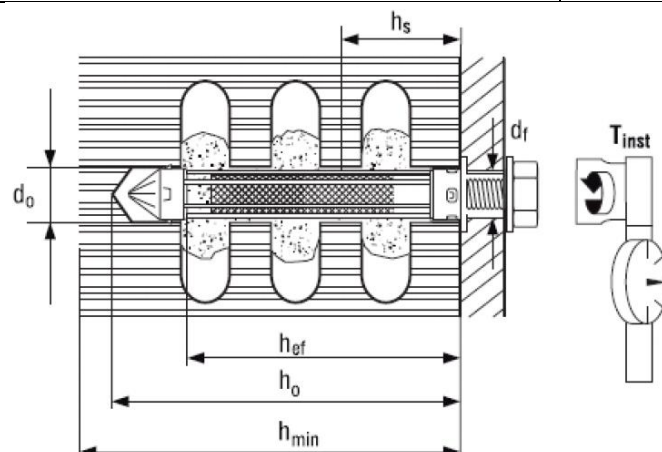
**Setting details for hollow bricks for HIT-IC**





Anchor size		HIT-IC + HIT-SC		
		M8	M10	M12
Sieve sleeve	HIT-SC	16x85	18x85	22x85
Nominal diameter of drill bit	$d_0$ [mm]	16	18	22
Effective anchorage and drill hole depth	$h_{ef}$ [mm]	80	80	80
Drill hole depth	$h_0$ [mm]	95	95	95
Minimum base material thickness	$h_{min}$ [mm]	115	115	115
Maximum diameter of clearance hole in the fixture	$d_f$ [mm]	9	12	14
Length of bolt engagement	$h_s$ [mm]	8...75	10...75	12...75
Torque moment	$T_{max}$ [Nm]	3	4	6
Filing volume	[ml]	30	36	45

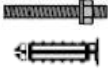

**Drilling and cleaning parameters for solid bricks**

HAS-U	HIT-IC	Drilling and cleaning	
		Hammer drill	Brush HIT-RB
		d <sub>0</sub> [mm]	size [mm]
			
<b>M8</b>	-	10	10
<b>M10</b>	-	12	12
<b>M12</b>	<b>M8</b>	14	14
-	<b>M10</b>	16	16
-	<b>M12</b>	18	18

**Drilling and cleaning parameters for hollow bricks**

HAS-U + sieve sleeve	HIT-IC + sieve sleeve	Drilling and cleaning	
		Hammer drill	Brush HIT-RB
		d <sub>0</sub> [mm]	size [mm]
			
<b>M8</b>	-	16	16
<b>M10</b>	<b>M8</b>	16	16
<b>M12</b>	<b>M10</b>	18	18
-	<b>M12</b>	-	22

## Setting instructions

\*For detailed information on installation see instruction for use given with the package of the product.



### Safety regulations.

Review the Material Safety Data Sheet (MSDS) before use for proper and safe handling! Wear well-fitting protective goggles and protective gloves when working with Hilti HIT-MM Plus.

### Drilling

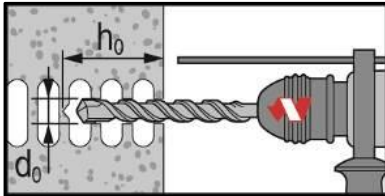

In hollow bricks: rotary mode

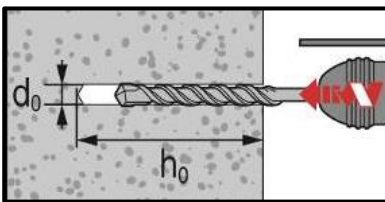

In solid bricks: hammer mode

### Cleaning

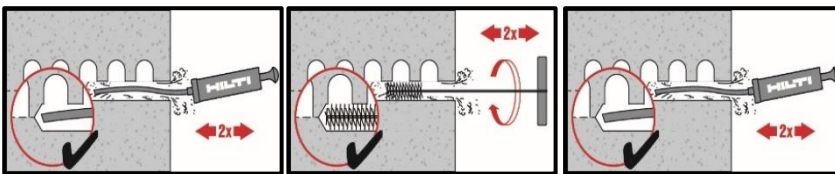

Manual cleaning (MC)

### Instructions for solid bricks without sieve sleeve

#### Injection system

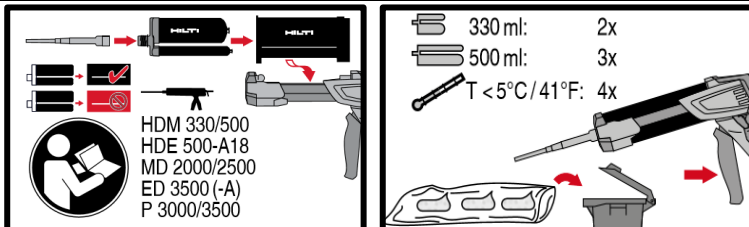

Injection system preparation.

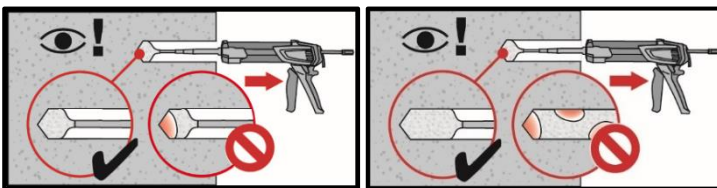

Injection method

### Setting the element

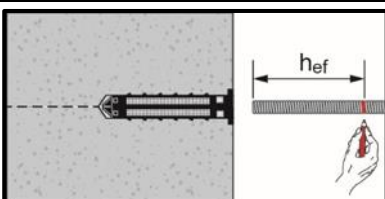

Presetting element, observe working time " $t_{work}$ ",

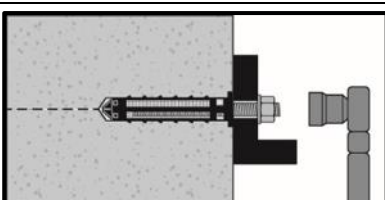

Loading the anchor: After required curing time  $t_{cure}$  the anchor can be loaded.

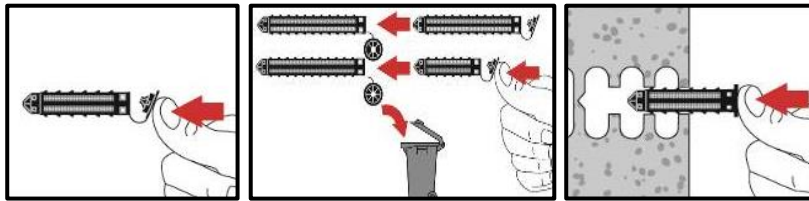
**Instructions for hollow and solid bricks with sieve sleeve**
**Preparation of the sieve sleeve**

Close lid and insert sieve sleeve manually

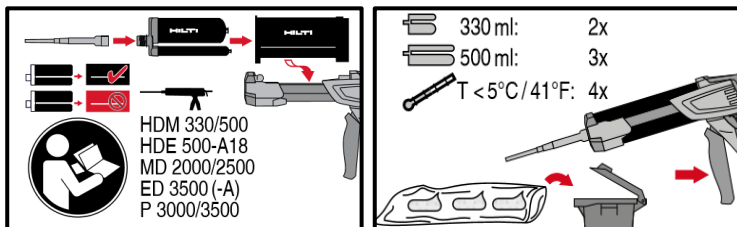
**Injection system**

Injection system preparation.

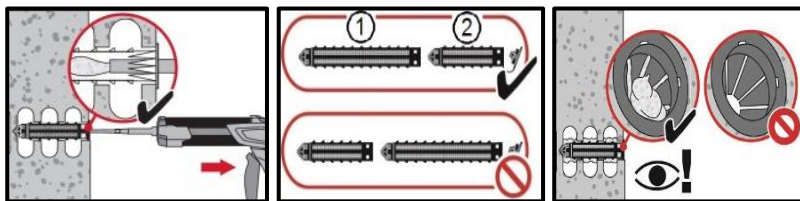
**Injection system: hollow bricks**

Installation with sieve sleeve HIT-SC

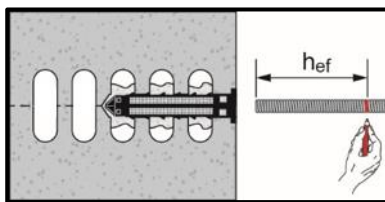
**Setting the element**

**Presetting element**, observe working time " $t_{work}$ ",

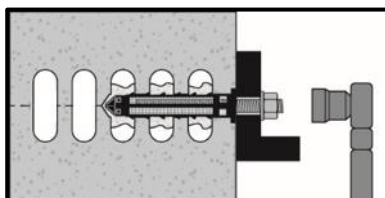

**Loading the anchor:** After required curing time  $t_{cure}$  the anchor can be loaded.

### 2.2.3 HIT-1/ HIT-1 CE

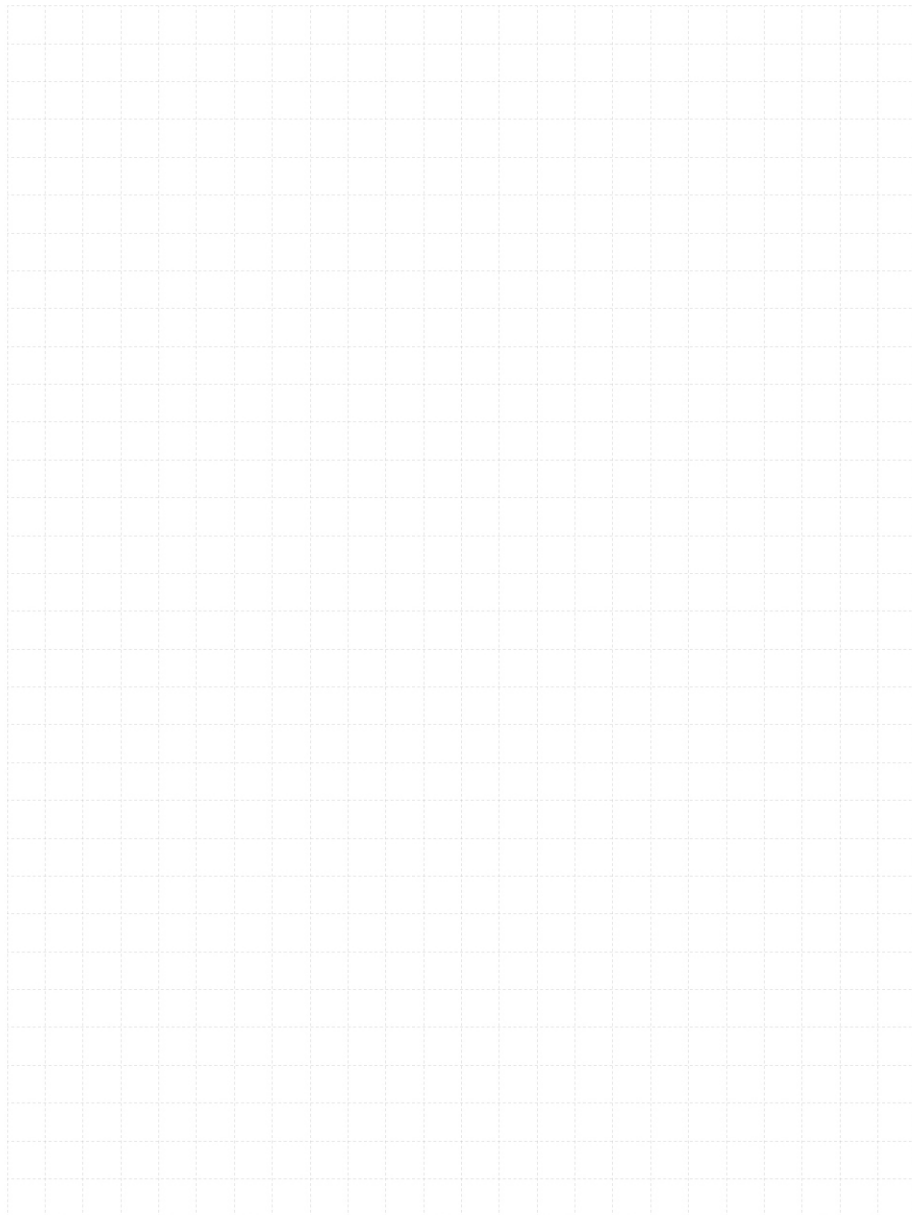

# HIT-1 / HIT-1 CE injection mortar

## Anchor design (EN 1992-4) / Rods / Concrete

### Injection mortar system



Hilti HIT-1 / HIT-1 CE  
300 ml tube cartridge



Anchor rods:  
HAS-U  
HAS-U HDG  
HAS-U A4  
HAS-U HCR  
(M8-M16)

### Benefits

- Chemical injection fastening
- Two-component hybrid mortar
- Rapid curing
- Suitable for overhead fastenings
- Versatile and convenient handling
- Clean and simple in use
- Small edge distance and anchor spacing
- Always correct mixing ratio
- In-service temperatures:

### Base material



Concrete  
(non-cracked)



Dry concrete



Wet concrete

### Load conditions

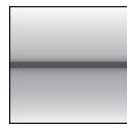

Static/  
quasi-static

### Installation conditions



Hammer  
drilling

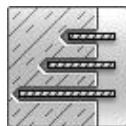

Variable  
embedment  
depth

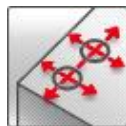

Small edge  
distance and  
spacing

### Other information



European  
Technical  
Assessment



CE  
conformity

### Approvals / certificates

Description	Authority / Laboratory	No. / date of issue
European Technical Assessment <sup>a)</sup>	TTIC, Prague	ETA-17/0005 / 2017-02-20

a) All data given in this section according to ETA-17/0005, issue 2017-02-20.

## Static and quasi-static loading (for a single anchor)

### All data in this section applies to

- Correct setting (See setting instruction)
- No edge distance and spacing influence
- Steel failure
- Base material thickness, as specified in the table
- Embedment depth as specified in the table
- Load values valid for holes drilled with TE rotary hammers in hammering mode
- Diamond coring is not permitted
- Concrete C 20/25,  $f_{ck,cube} = 25 \text{ N/mm}^2$
- In-service temperature range I  
(min. base material temperature  $-40^\circ\text{C}$ , max. long/short term base material temperature:  $+24^\circ\text{C}/+40^\circ\text{C}$ )

### Embedment depth <sup>a)</sup> and base material thickness

Anchor size			M8			M10			M12			M16		
Embedment depth <sup>b)</sup>	$h_{ef}$	[mm]	60	80	160	60	100	200	70	120	240	80	160	320
Base material thickness	$h$	[mm]	100	110	190	100	130	210	100	150	270	116	196	356

a) The allowed range of embedment depth is shown in the setting details

b) Recommended loads calculated for embedment depths  $h_{ef} = h_{ef,min}$ ;  $h_{ef} = 10d$ ;  $h_{ef} = h_{ef,max} = 20d$

### Recommended loads

Anchor size				M8			M10			M12			M16		
<b>Non-cracked concrete</b>															
Tension	HAS-U 5.8	$N_{rec}$	[kN]	4,2	5,6	8,7	5,2	8,7	13,8	7,3	12,6	20,1	9,6	19,1	37,4
Shear	HAS-U 5.8	$V_{rec}$	[kN]	5,2			8,3			12,0			22,4		

**Materials**
**Mechanical properties**

Anchor size				M8	M10	M12	M16
Nominal tensile strength	HAS-U 5.8	$f_{uk}$	[N/mm <sup>2</sup> ]	500	500	500	500
	HAS-U 8.8			800	800	800	800
	HAS-U-R			700	700	700	700
	HAS-U-HCR			800	800	800	800
Yield strength	HAS-U 5.8	$f_{yk}$	[N/mm <sup>2</sup> ]	400	400	400	400
	HAS-U 8.8			640	640	640	640
	HAS-U-R			450	450	450	450
	HAS-U-HCR			640	640	640	640
Stressed cross-section	HAS-U	$A_s$	[mm <sup>2</sup> ]	36,6	58,0	84,3	157
Moment of resistance	HAS-U	$W$	[mm <sup>3</sup> ]	31,2	62,3	109	277

**Material quality for HAS-U**

Part	Material
<b>Zinc coated steel</b>	
Threaded rod, HAS-U 5.8 (HDG)	Strength class 5.8; Elongation at fracture A5 > 8% ductile Electroplated zinc coated $\geq 5\mu\text{m}$ ; (HDG) hot dip galvanized $\geq 45\mu\text{m}$
Threaded rod, HAS-U 8.8 (HDG)	Strength class 8.8; Elongation at fracture A5 > 12% ductile Electroplated zinc coated $\geq 5\mu\text{m}$ ; (HDG) hot dip galvanized $\geq 45\mu\text{m}$
Washer	Electroplated zinc coated $\geq 5\mu\text{m}$ , hot dip galvanized $\geq 45\mu\text{m}$
Nut	Strength class of nut adapted to strength class of threaded rod. Electroplated zinc coated $\geq 5\mu\text{m}$ , hot dip galvanized $\geq 45\mu\text{m}$
<b>Stainless Steel</b>	
Threaded rod, HAS-U A4	Strength class 70 for M8-M16 Elongation at fracture A5 > 8% ductile Stainless steel 1.4401; 1.4404; 1.4578; 1.4571; 1.4439; 1.4362
Washer	Stainless steel 1.4401, 1.4404, 1.4578, 1.4571, 1.4439, 1.4362 EN 10088-1:2014
Nut	Stainless steel 1.4401, 1.4404, 1.4578, 1.4571, 1.4439, 1.4362 EN 10088-1:2014
<b>High corrosion resistant steel</b>	
Threaded rod, HAS-U HCR	Strength class 80 for M8-M16 Elongation at fracture A5 > 8% ductile High corrosion resistance steel 1.4529; 1.4565;
Washer	High corrosion resistant steel 1.4529, 1.4565 EN 10088-1:2014
Nut	High corrosion resistant steel 1.4529, 1.4565 EN 10088-1:2014



## Setting information

### Installation temperature range:

-5°C to +40°C

### Service temperature range

Hilti HIT-1 / HIT-1 CE injection mortar may be applied in the temperature ranges given below. An elevated base material temperature may lead to a reduction of the design bond resistance.

Temperature range	Base material temperature	Maximum long term base material temperature	Maximum short term base material temperature
Temperature range I	-40 °C to +40 °C	+24 °C	+40 °C
Temperature range II	-40 °C to +80 °C	+50 °C	+80 °C

### Maximum short term base material temperature

Short-term elevated base material temperatures are those that occur over brief intervals, e.g. as a result of diurnal cycling.

### Maximum long term base material temperature

Long-term elevated base material temperatures are roughly constant over significant periods of time.

### Working time and curing time <sup>a)</sup>:

Temperature of the base material	Maximum working time	Minimum curing time
$T_{BM}$	$t_{work}$	$t_{cure}$
$-5^{\circ}\text{C} \leq T_{BM} < 0^{\circ}\text{C}$	1,5 h	6 h
$0^{\circ}\text{C} \leq T_{BM} < 5^{\circ}\text{C}$	45 min	3 h
$5^{\circ}\text{C} \leq T_{BM} < 10^{\circ}\text{C}$	25 min	2 h
$10^{\circ}\text{C} \leq T_{BM} < 15^{\circ}\text{C}$	20 min	100 min
$15^{\circ}\text{C} \leq T_{BM} < 20^{\circ}\text{C}$	15 min	80 min
$20^{\circ}\text{C} \leq T_{BM} < 30^{\circ}\text{C}$	6 min	45 min
$30^{\circ}\text{C} \leq T_{BM} < 34^{\circ}\text{C}$	4 min	25 min
$35^{\circ}\text{C} \leq T_{BM} < 40^{\circ}\text{C}$	2 min	20 min

a) The curing time data are valid for dry base material only. In wet base material the curing times must be doubled

**Setting details**





Anchor size			M8	M10	M12	M16	
Nominal diameter of element	d	[mm]	8	10	12	16	
Nominal diameter of drill bit	d <sub>0</sub>	[mm]	10	12	14	18	
Maximum diameter of clearance hole in the fixture	d <sub>f</sub>	[mm]	9	12	14	18	
Effective anchorage depth (= drill hole depth)	h <sub>ef,min</sub> = h <sub>0</sub>	[mm]	60	60	70	80	
	h <sub>ef,max</sub> = h <sub>0</sub>	[mm]	160	200	240	320	
Minimum base material thickness	h <sub>min</sub>	[mm]	h <sub>ef</sub> + 30 mm ≥ 100 mm				h <sub>ef</sub> + 2d <sub>0</sub>
Maximum torque moment	T <sub>max</sub>		10	20	40	80	
Minimum spacing	s <sub>min</sub>	[mm]	40	50	60	80	
Minimum edge distance	c <sub>min</sub>	[mm]	40	50	60	80	

**Installation equipment**

Anchor size	M8	M10	M12	M16
Rotary hammer	TE2(-A) – TE30(-A)			
Other tools	Blow out pump (h <sub>ef</sub> ≤ 10·d) Compressed air gun <sup>b)</sup> Set of cleaning brushes <sup>c)</sup> , dispenser, piston plug			

- a) Compressed air gun with extension hose for all drill holes deeper than 250 mm (for M8 to M12) or deeper than 20·φ (for φ > 12 mm)  
 b) Automatic brushing with round brush for all drill holes deeper than 250 mm (for M8 to M12) or deeper than 20·φ (for φ > 12 mm)

**Parameters of cleaning and setting tools**

HAS-U	Drilling and cleaning		Installation
	Hammer drilling	Brush HIT-RB	Piston plug HIT-SZ
	d <sub>0</sub> [mm]	size [mm]	size [mm]
			
<b>M8</b>	10	10	10
<b>M10</b>	12	12	12
<b>M12</b>	14	14	14
<b>M16</b>	18	18	18

## Setting instructions

\*For detailed information on installation see instruction for use given with the package of the product.



### Safety regulations.

Review the Material Safety Data Sheet (MSDS) before use for proper and safe handling! Wear well-fitting protective goggles and protective gloves when working with Hilti HIT-1 / HIT-1 CE.

### Drilling

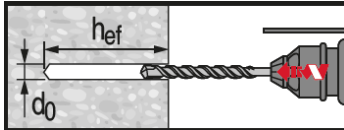

#### Hammer drilled hole (HD)

For dry and wet concrete only

### Cleaning

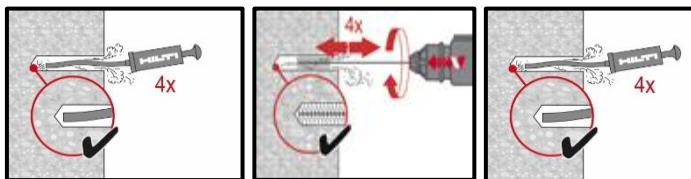

#### Manual cleaning with machine brushing (MCMC)

For drill diameters  $d_0 \leq 20$  mm and drill hole depth  $h_0 \leq 10 \cdot d_0$ .

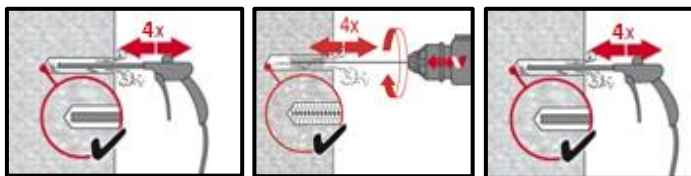

#### Compressed air cleaning with machine brushing (CACMB)

For drill diameters  $d_0$  and all drill hole depth  $h_0$ .

### Injection system

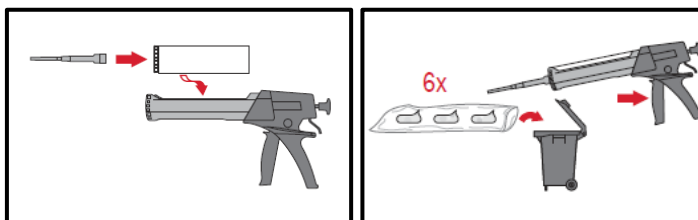

#### Injection system preparation

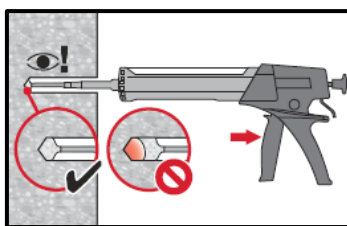

#### Injection method for drill hole depth (approx. 2/3 full)

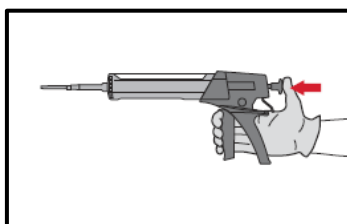

#### Depressurization of the dispenser.

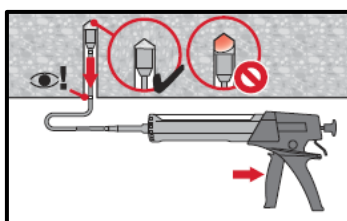

#### Injection method for overhead application and/or installation with embedment depth $h_{ef} > 250$ mm.

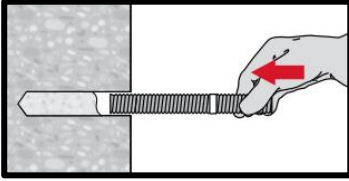
**Setting the element**

**Setting the element**, observe working time " $t_{work}$ ",

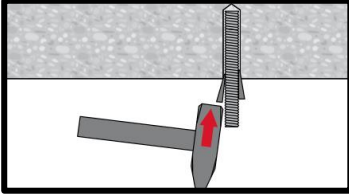

**Setting element** for overhead applications, observe working time " $t_{work}$ ",

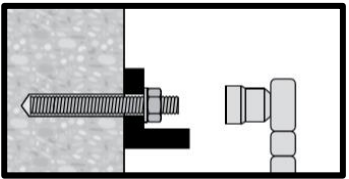

**Loading the anchor:** After required curing time  $t_{cure}$  the anchor can be loaded.

# HIT-1 / HIT-1 CE injection mortar

## Anchor design (ETAG 029) / Rods and Sleeves / Masonry

### Injection mortar system



Hilti HIT-1 / HIT-1 CE  
300 ml tube cartridge



Anchor rods:  
HAS-U  
HAS-U HDG  
HAS-U A4  
HAS-U HCR  
(M8-M12)

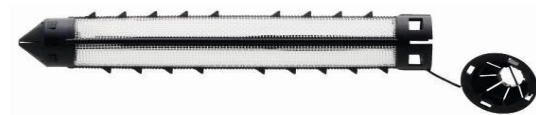

Sieve sleeve:  
HIT-SC  
(16)

### Benefits

- Hollow and solid masonry: clay bricks
- Two-component hybrid mortar
- Rapid curing
- Suitable for overhead fastenings
- Versatile and convenient handling
- Flexible setting depth and fastening thickness
- Small edge distance and anchor spacing
- Mortar filling control with HIT-SC sleeves

### Base material

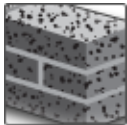

Solid bricks

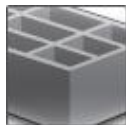

Hollow bricks

### Load conditions



Static/  
quasi-static

### Installation conditions

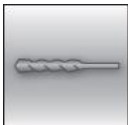

Hammer/rotary  
drilling

### Approvals / certificates

Description	Authority / Laboratory	No. / date of issue
Hilti Technical Data <sup>a)</sup>	Hilti	2017-11-28

b) All data given in this section according to Hilti Technical Data.

## Static and quasi-static loading (for a single anchor)

### All data in this section applies to

- Load values valid for holes drilled with TE rotary hammers in hammer mode for solid bricks
- Load values valid for holes drilled with TE rotary hammers in rotary mode for hollow bricks
- Correct anchor setting (see instruction for use, setting details)
- Steel quality of fastening elements: see data below
- Threaded rods of appropriate size (diameter and length) and a minimum steel quality of 5.6 can be used
- Base material temperature during installation and curing must be between 0°C through +40°C
- In-service temperature ranges:  
 Ta = -40°C to +40°C (max. long term temperature +24 °C and max.short term temperature +40 °C)  
 Tb = -40°C to +80°C (max. long term temperature +50 °C and max.short term temperature +80 °C)

### Recommended loads for solid and hollow bricks

Load type	Anchor size	h <sub>ef</sub> [mm]	f <sub>b</sub> [N/mm <sup>2</sup> ]	Loads [kN]		
				Ta	Tb	
<b>Solid clay brick</b>						
N <sub>Rec</sub>	HAS-U	M8	80	28	0,7	0,4
		M10	90		0,7	0,4
		M12	100		0,7	0,4
	HAS-U + HIT-SC M16x85	M8	80	28	0,9	0,6
		M10			0,9	0,6
		M12			0,9	0,6
V <sub>Rec</sub>	HAS-U	M8	80	28	1,3	
		M10	90		1,7	
		M12	100		2,5	
	HAS-U + HIT-SC M16x85	M8	80	28	1,3	
		M10			1,6	
		M12			1,7	
<b>Hollow brick – Hz 12</b>						
N <sub>Rec</sub>	HAS-U + HIT-SC M16x85	M8	80	12	0,35	0,20
		M10			0,35	0,20
		M12			0,45	0,25
V <sub>Rec</sub>	HAS-U + HIT-SC M16x85	M8, M10, M12	80	12	1,4	
<b>Hollow brick – Doppio Uni</b>						
N <sub>Rec</sub>	HAS-U + HIT-SC M16x85	M8	80	28	0,25	0,15
		M10			0,25	0,20
		M12			0,35	0,20
V <sub>Rec</sub>	HAS-U + HIT-SC M16x85	M8, M10, M12	80	28	0,85	

Due to the wide variety of bricks, site tests have to be performed for determination of load values for all applications outside of the above mentioned base materials and/or setting conditions.

**Materials**
**Material quality**

Part	Material
<b>Zinc coated steel</b>	
Threaded rod, HAS-U 5.8 (HDG)	Strength class 5.8; Elongation at fracture A5 > 8% ductile Electroplated zinc coated $\geq 5\mu\text{m}$ ; (HDG) hot dip galvanized $\geq 45\mu\text{m}$
Threaded rod, HAS-U 8.8 (HDG)	Strength class 8.8; Elongation at fracture A5 > 12% ductile Electroplated zinc coated $\geq 5\mu\text{m}$ ; (HDG) hot dip galvanized $\geq 45\mu\text{m}$
Washer	Electroplated zinc coated $\geq 5\mu\text{m}$ , hot dip galvanized $\geq 45\mu\text{m}$
Nut	Strength class of nut adapted to strength class of threaded rod. Electroplated zinc coated $\geq 5\mu\text{m}$ , hot dip galvanized $\geq 45\mu\text{m}$
<b>Stainless Steel</b>	
Threaded rod, HAS-U A4	Strength class 70 for M8-M12 Elongation at fracture A5 > 8% ductile Stainless steel 1.4401; 1.4404; 1.4578; 1.4571; 1.4439; 1.4362
Washer	Stainless steel 1.4401, 1.4404, 1.4578, 1.4571, 1.4439, 1.4362 EN 10088-1:2014
Nut	Stainless steel 1.4401, 1.4404, 1.4578, 1.4571, 1.4439, 1.4362 EN 10088-1:2014
<b>High corrosion resistant steel</b>	
Threaded rod, HAS-U HCR	Strength class 80 for M8-M12 Elongation at fracture A5 > 8% ductile High corrosion resistance steel 1.4529; 1.4565;
Washer	High corrosion resistant steel 1.4529, 1.4565 EN 10088-1:2014
Nut	High corrosion resistant steel 1.4529, 1.4565 EN 10088-1:2014
<b>Sieve sleeve</b>	
HIT-SC sleeve	Frame: FPP 20T, Sieve: PA6,6 N500/200

## Setting information

### Installation temperature range:

0°C to +40°C

### Service temperature range

Hilti HIT-1 / HIT-1 CE injection mortar may be applied in the temperature ranges given below. An elevated base material temperature may lead to a reduction of the design bond resistance.

Temperature range	Base material temperature	Maximum long term base material temperature	Maximum short term base material temperature
Temperature range I	-40 °C to +40 °C	+24 °C	+40 °C
Temperature range II	-40 °C to +80 °C	+50 °C	+80 °C

### Maximum short term base material temperature

Short term elevated base material temperatures are those that occur over brief intervals, e.g. as a result of diurnal cycling.

### Maximum long term base material temperature

Long term elevated base material temperatures are roughly constant over significant periods of time.

### Working time and curing time:

Temperature of the base material	Maximum working time	Minimum curing time
$T_{BM}$	$t_{work}$	$t_{cure}$
$0^{\circ}\text{C} \leq T_{BM} < 5^{\circ}\text{C}$	45 min	3 h
$5^{\circ}\text{C} \leq T_{BM} < 10^{\circ}\text{C}$	25 min	2 h
$10^{\circ}\text{C} \leq T_{BM} < 20^{\circ}\text{C}$	15 min	100 min
$20^{\circ}\text{C} \leq T_{BM} < 30^{\circ}\text{C}$	6 min	45 min
$30^{\circ}\text{C} \leq T_{BM} < 40^{\circ}\text{C}$	2 min	25 min



**Setting details for solid bricks**

Anchor size		M8		M10		M12	
Sieve sleeve	HIT-SC	-	16x85	-	16x85	-	16x85
Nominal diameter of drill bit	$d_o$ [mm]	10	16	12	16	14	18
Maximum diameter of clearance hole in the fixture	$d_f$ [mm]	9	9	12	12	14	14
Effective anchorage depth	$h_{ef}$ [mm]	80	80	90	80	100	80
Hole depth	$h_o$ [mm]	80	95	90	95	100	95
Minimum base material thickness	$h_{min}$ [mm]	115	115	115	115	115	115
Maximum torque moment	$T_{max}$ [Nm]	6	6	10	8	10	8

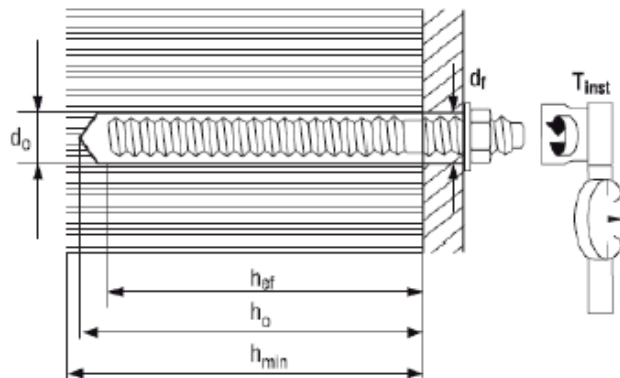
**Setting details for hollow bricks**



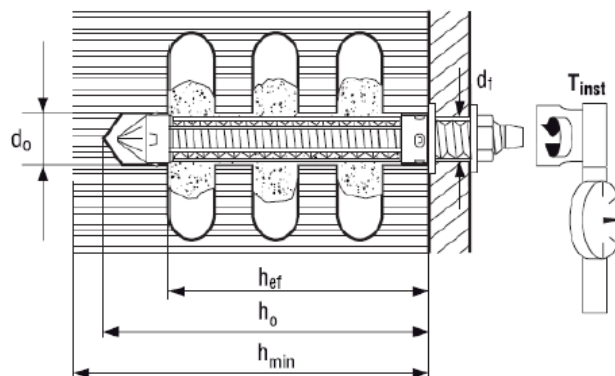

Anchor Size		M8		M10		M12	
		HLZ2	Doppio Uni	HLZ2	Doppio Uni	HLZ2	Doppio Uni
Sieve sleeve	HIT-SC	16x85		16x85		16x85	
Nominal diameter of drill bit	$d_o$ [mm]	16		16		18	
Maximum diameter of clearance hole in the fixture	$d_f$ [mm]	9		12		14	
Effective anchorage depth	$h_{ef}$ [mm]	80		80		80	
Hole depth	$h_o$ [mm]	95		95		95	
Minimum base material thickness	$h_{min}$ [mm]	115		115		115	
Maximum torque moment	$T_{max}$ [Nm]	4		4		4	



**Installation equipment**

Anchor – size	M8	M10	M12
Rotary hammer	TE2(-A) – TE30(-A)		
Other tools	Blow out pump Set of cleaning brushes, dispenser		

**Cleaning and setting parameters for solid and hollow bricks**

HAS-U	Sieve sleeve HIT-SC	Drilling	Cleaning
		Hammer drilling	Brush HIT-RB
		d <sub>0</sub> [mm]	size [mm]
			
<b>M8</b> <sup>a)</sup>	-	10	10
<b>M10</b> <sup>a)</sup>	-	12	12
<b>M12</b> <sup>a)</sup>	-	14	14
<b>M8</b>	HIT-SC 16x85	16	16
<b>M10</b>	HIT-SC 16x85	16	16
<b>M12</b>	HIT-SC 18x85	18	18

a) Installation without the sieve sleeve HIT-SC can be used only in case of solid bricks.

## Setting instructions

\*For detailed information on installation see instruction for use given with the package of the product.



### Safety regulations.

Review the Material Safety Data Sheet (MSDS) before use for proper and safe handling! Wear well-fitting protective goggles and protective gloves when working with Hilti HIT-1 / HIT-1 CE.

### Drilling

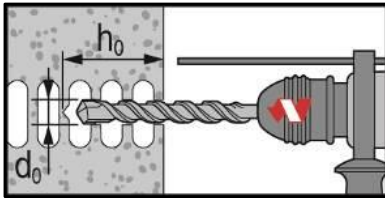

In hollow bricks: rotary mode

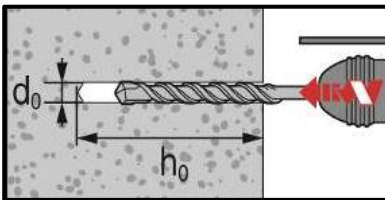

In solid bricks: hammer mode

### Cleaning

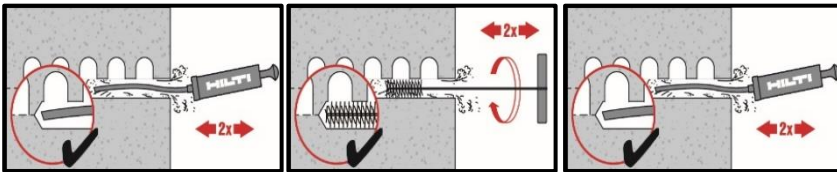

Manual cleaning (MC)

### Instructions for solid bricks without sieve sleeve

#### Injection system

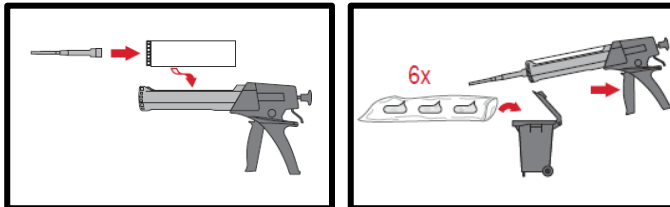

Injection system preparation.

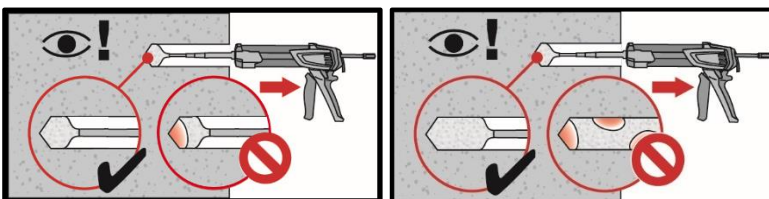

Injection method for drill hole

#### Setting the element

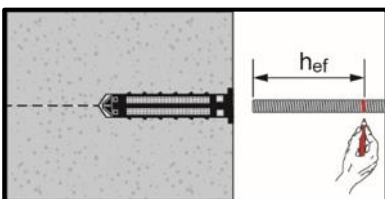

Presetting element, observe working time " $t_{work}$ ",

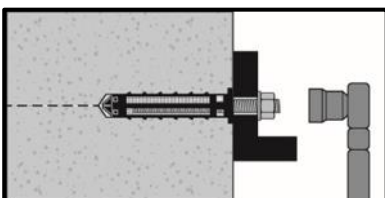

Loading the anchor: After required curing time  $t_{cure}$  the anchor can be loaded.

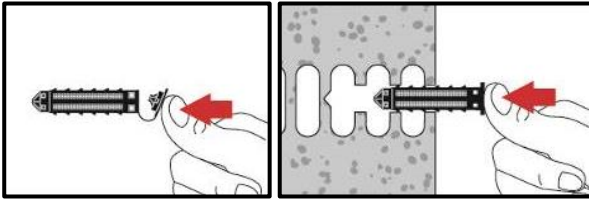
**Instructions for hollow and solid bricks with sieve sleeve****Preparation of the sieve sleeve**

Close lid and insert sieve sleeve manually

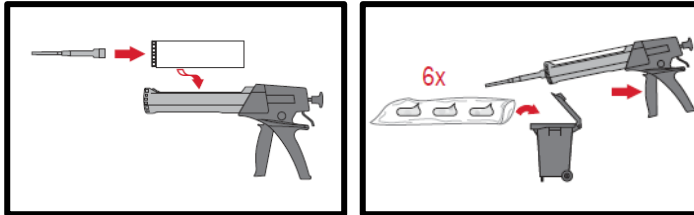
**Injection system**

Injection system preparation.

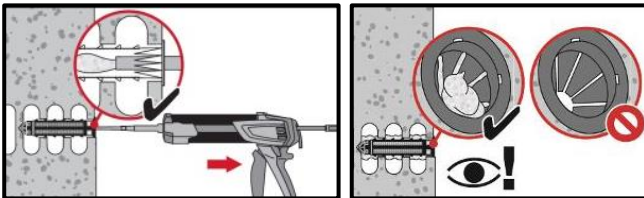
**Injection system: hollow bricks**

Installation with sieve sleeve HIT-SC

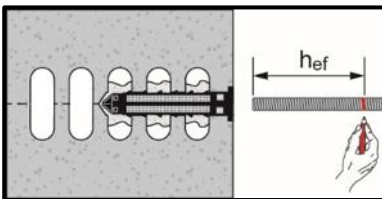
**Setting the element**

**Presetting element**, observe working time " $t_{work}$ ",

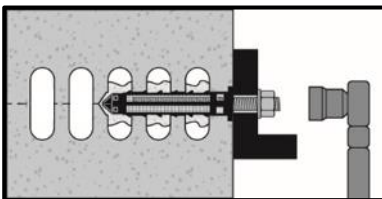

**Loading the anchor**: After required curing time  $t_{cure}$  the anchor can be loaded.

## 2.3 Masonry

### 2.3.1 HIT-HY 270

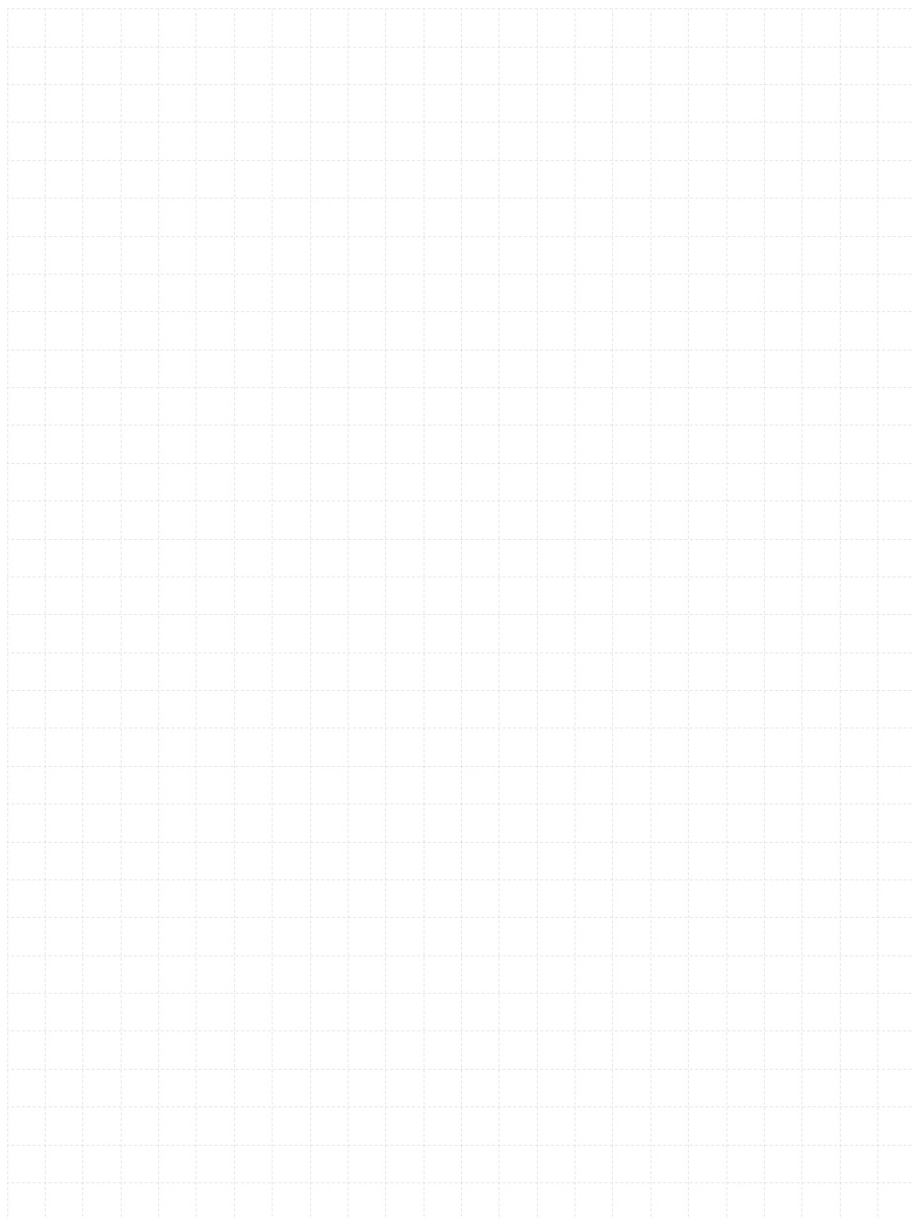

# HIT-HY 270 injection mortar

Anchor design (EOTA TR 054) / Rods and Sleeves / Masonry

Injection mortar system		Benefits
	Hilti HIT-HY 270  330 ml foil pack (also available as 500 ml foil pack)	<ul style="list-style-type: none"> <li>- Chemical injection fastening for the most common types of base materials:</li> <li>- Hollow and solid clay bricks, calcium silicate bricks, normal and light weight concrete blocks</li> <li>- Two-component hybrid mortar</li> <li>- Versatile and convenient handling with HDE dispenser</li> </ul>
	Anchor rod: HIT-V HIT-V-F HIT-V-R HIT-V-HCR rods (M6-M16)	<ul style="list-style-type: none"> <li>- Flexible setting depth and fastening thickness</li> <li>- Small edge distance and anchor spacing</li> </ul>
	Anchor rod: HAS-U HAS-U HDG HAS-U A4 HAS-U HCR rods (M6-M16)	<ul style="list-style-type: none"> <li>- Suitable for overhead fastenings</li> <li>- ETA approved for seismic loads in solid clay bricks (Rosso Vivo, Rosso Classico)</li> </ul>
	Rebar B500 ( $\phi 8$ , $\phi 12$ )	
	Internally threaded sleeve: HIT-IC (M8-M12)	
	Sieve sleeves: HIT-SC (12-22)	

## Base material Load conditions

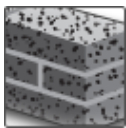

Solid brick

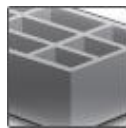

Hollow brick

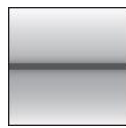

Static/  
quasi-static



Seismic



Fire  
resistance

## Installation conditions Other informations

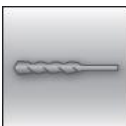

Hammer  
drilling

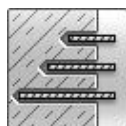

Variable  
embedment  
depth

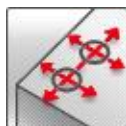

Small edge  
distance and  
spacing



European  
Technical  
Assessment



CE  
conformity

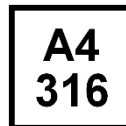

Corrosion  
resistance



High  
corrosion  
resistance



PROFIS  
Engineering  
design  
Software

## Approvals / certificates

Description	Authority / Laboratory	No. / date of issue
European technical assessment	DIBt, Berlin	ETA-13/1036 / 2017-12-12
European technical assessment	DIBt, Berlin	ETA-19/0160 / 2019-04-29
European technical assessment	CSTB, Paris	ETA-22/0395 / 2022-08-11
Hilti Technical Data <sup>a)</sup>	Hilti	2019-05-20
Fire test report	MFPA, Leipzig	GS 6.1/19-035-5 / 2020-10-30

a) Hilti Technical Data is based on testing and assessment by Hilti following EAD 330076-00-0604, EOTA TR053 and TR054

## Brick types and properties

### Instruction to this technical data

- Identify/choose your brick (or brick type) and its geometrical/physical properties on the following tables. Information about edge and spacing criteria is available on page 5.
  - The pages referred on the last column of the table below contain the design resistance loads for pull-out failure of the anchor, brick breakout failure and local brick failure for each respective brick. Notice that the data displayed on these tables is only valid for single anchors with distance to edge such that loading capacity is not influenced by it – for other cases not covered, use PROFIS Engineering software, consult ETA-13/1036, ETA-19/0160, ETA-22/0395 or contact Hilti Engineering Team.
- The resistance loads provided by this technical data manual are valid only for exact same masonry unit (hollow bricks) or for units made of the same base material with equal or higher size and compressive strength (solid bricks). For other cases, on-site tests must be performed-please consult page 18.

### Exterior brick dimensions

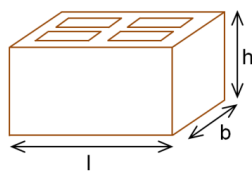

Generic bricks

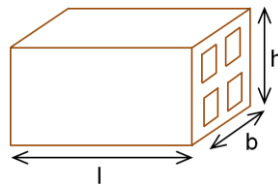

Bricks HC5, CC1 and CC2

### Interior dimensions of the majority of the holes

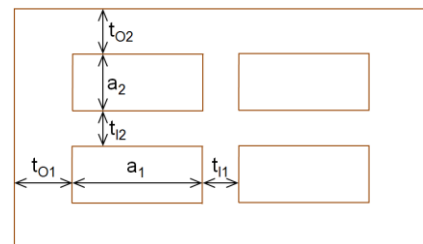

## Brick types and properties

Brick code	Data	Brick name	Image	Size [mm]	t <sub>0</sub> [mm]	t <sub>1</sub> [mm]	a [mm]	f <sub>b</sub> [N/mm <sup>2</sup> ]	ρ [kg/dm <sup>3</sup> ]	Page
<b>Solid clay</b>										
SC1	ETA	Solid clay brick Mz, 1DF		l: ≥ 240 b: ≥ 115 h: ≥ 52	-	-	-	12 20 40	2,0	10
SC2	ETA	Solid clay brick Mz, NF		l: ≥ 240 b: ≥ 115 h: ≥ 72	-	-	-	10 20	2,0	10
SC3	ETA	Solid clay brick Mz, 2DF		l: ≥ 240 b: ≥ 115 h: ≥ 113	-	-	-	12 20	2,0	11
SC4	Hilti Data	UK London yellow Multi Stock		l: 215 b: 100 h: 65	-	-	-	16	1,5	12
SC5	Hilti Data	Australian common dry pressed		l: 230 b: 110 h: 76	-	-	-	25	2,0	12
SC6	ETA	Rosso Classico Rosso Vivo		l: 250 b: 120 h: 55	-	-	-	18	1,6	12



**Brick types and properties**









Brick code	Data	Brick name	Image	Size [mm]	t <sub>0</sub> [mm]	t <sub>1</sub> [mm]	a [mm]	f <sub>b</sub> [N/mm <sup>2</sup> ]	ρ [kg/dm <sup>3</sup> ]	Page
<b>Hollow clay</b>										
HC1	ETA	Hollow clay brick Hz, 10DF		l: 300 b: 240 h: 238	t <sub>01</sub> : 12 t <sub>02</sub> : 15	t <sub>11</sub> : 11 t <sub>12</sub> : 15	a <sub>1</sub> : 10 a <sub>2</sub> : 25	12 20	1,4	13
HC2	Hilti Data	Italy Mattone Alveolater 50		l: 300 b: 245 h: 185	t <sub>01</sub> : 12 t <sub>02</sub> : 12	t <sub>11</sub> : 9 t <sub>12</sub> : 9	a <sub>1</sub> : 22 a <sub>2</sub> : 25	16	1,0	13
HC3	Hilti Data	Spain Termoarcilla		l: 300 b: 192 h: 190	t <sub>01</sub> : 9 t <sub>02</sub> : 9	t <sub>11</sub> : 7 t <sub>12</sub> : 7	a <sub>1</sub> : 17 a <sub>2</sub> : --	22	0,9	13
HC4	Hilti Data	Belgium Wienerberger Thermobrick		l: 285 b: 135 h: 138	t <sub>01</sub> : 10 t <sub>02</sub> : 10	t <sub>11</sub> : 7 t <sub>12</sub> : 7	a <sub>1</sub> : 14 a <sub>2</sub> : 34	21	0,9	13
HC5	Hilti Data	Spain Hueco doble		l: 232 b: 115 h: 78	t <sub>01</sub> : 9 t <sub>02</sub> : 9	t <sub>11</sub> : 8 t <sub>12</sub> : 8	a <sub>1</sub> : 28 a <sub>2</sub> : 28	4	0,8	14
HC6	Hilti Data	Belgium Wienerberger Powerbrick		l: 285 b: 135 h: 135	t <sub>01</sub> : 16 t <sub>02</sub> : 12	t <sub>11</sub> : 10 t <sub>12</sub> : 10	a <sub>1</sub> : 12 a <sub>2</sub> : 31	41	1,2	14
HC7	Hilti Data	Italy Doppio uni		l: 240 b: 120 h: 120	t <sub>01</sub> : 12 t <sub>02</sub> : 12	t <sub>11</sub> : 10 t <sub>12</sub> : 12	a <sub>1</sub> : 22 a <sub>2</sub> : 24	27	1,1	14
HC8	Hilti Data	Spain Ladrillo cara vista		l: 240 b: 115 h: 49	t <sub>01</sub> : 13 t <sub>02</sub> : 16	t <sub>11</sub> : 7 t <sub>12</sub> : 7	a <sub>1</sub> : 30 a <sub>2</sub> : 33	42	1,2	14
HC9	Hilti Data	Spain Clinker mediterraneo		l: 240 b: 115 h: 49	t <sub>01</sub> : 17 t <sub>02</sub> : 17	t <sub>11</sub> : 7 t <sub>12</sub> : 7	a <sub>1</sub> : 29 a <sub>2</sub> : 29	78	1,3	15
HC10	Hilti Data	UK Nostell red multi		l: 215 b: 102 h: 65	t <sub>01</sub> : 23 t <sub>02</sub> : 21	t <sub>11</sub> : 28 t <sub>12</sub> : --	a <sub>1</sub> : 38 a <sub>2</sub> : 56	70	1,6	15
HC11	Hilti Data	Australian common standard		l: 230 b: 110 h: 76	t <sub>01</sub> : 20 t <sub>02</sub> : 16	t <sub>11</sub> : 16 t <sub>12</sub> : 20	a <sub>1</sub> : 25 a <sub>2</sub> : 36	84	1,5	15
<b>Clay Ceiling</b>										
CC1	ETA	Clay ceiling brick Ds-1,0		l: 250 b: 510 h: 180	t <sub>01</sub> : 12 t <sub>02</sub> : 12	t <sub>11</sub> : 7 t <sub>12</sub> : 7	a <sub>1</sub> : 14 a <sub>2</sub> : 32	3	1,0	16
CC2	Hilti Data	Italy Mattone rosso		l: 250 b: 400 h: 180	t <sub>01</sub> : 9 t <sub>02</sub> : 9	t <sub>11</sub> : 7 t <sub>12</sub> : 7	a <sub>1</sub> : 69 a <sub>2</sub> : 55	26	0,6	16
<b>Solid Calcium Silicate</b>										
SCS1	ETA	Solid silica brick KS, 2DF		l: ≥ 240 b: ≥ 115 h: ≥ 113	-	-	-	12 28	2,0	16
SCS2	ETA	Solid silica brick KS, 8DF		l: ≥ 248 b: ≥ 240 h: ≥ 248	-	-	-	12 20 28	2,0	16



**Brick types and properties**

Brick code	Data	Brick name	Image	Size [mm]	t <sub>0</sub> [mm]	t <sub>1</sub> [mm]	a [mm]	f <sub>b</sub> [N/mm <sup>2</sup> ]	ρ [kg/dm <sup>3</sup> ]	Page
<b>Hollow Calcium Silicate</b>										
HCS1	ETA	Hollow silica brick KSL, 8DF		l: 248 b: 240 h: 238	t <sub>01</sub> : 34 t <sub>02</sub> : 22	t <sub>11</sub> : 11 t <sub>12</sub> : 20	a <sub>1</sub> : 52 a <sub>2</sub> : 52	12 20	1,4	17
HCS2	Hilti Data	Germany KSL 12		l: 240 b: 175 h: 113	t <sub>01</sub> : 18 t <sub>02</sub> : 20	t <sub>11</sub> : -- t <sub>12</sub> : --	a <sub>1</sub> : -- a <sub>2</sub> : --	12	1,6	17
<b>Solid Light weight concrete</b>										
SLWC1	ETA	Solid lightweight concrete brick Vbl, 2DF		l: ≥ 240 b: ≥ 115 h: ≥ 113	-	-	-	4 6	0,9	18
SLWC2	Hilti Data	Sweden Leca typ 3		l: 550 b: 190 h: 190	-	-	-	3	0,6	18
SLWC3	Hilti Data	Italy "Tufo" volcanic rock		l: 380 b: 270 h: 270	-	-	-	4	1,2	18
<b>Hollow Light weight concrete</b>										
HLWC1	ETA	Hollow lightweight concrete brick Hbl, 16DF		l: 495 b: 240 h: 238	t <sub>01</sub> : 25 t <sub>02</sub> : 51	t <sub>11</sub> : 35 t <sub>12</sub> : 36	a <sub>1</sub> : 196 a <sub>2</sub> : 52	2 6	0,7	18
HLWC2	Hilti Data	Germany Hbl 2		l: 248 b: 300 h: 248	t <sub>01</sub> : 17 t <sub>02</sub> : 21	t <sub>11</sub> : 24 t <sub>12</sub> : 22	a <sub>1</sub> : 87 a <sub>2</sub> : 40	2	0,6	19
HLWC3	Hilti Data	Germany Hbl 4		l: 248 b: 240 h: 248	t <sub>01</sub> : 48 t <sub>02</sub> : 41	t <sub>11</sub> : -- t <sub>12</sub> : 62	a <sub>1</sub> : 140 a <sub>2</sub> : 49	4	0,7	19
<b>Solid Normal weight concrete</b>										
SNW C1	ETA	Solid normal weight concrete brick Vbn, 2DF		l: ≥ 240 b: ≥ 115 h: ≥ 113	-	-	-	6 16	2,0	19
SNW C2	Hilti Data	UK Dense Concrete b=100mm		l: 440 b: 100 h: 215	-	-	-	14	2,0	19
SNW C3	Hilti Data	UK Dense concrete b=140mm		l: 440 b: 140 h: 215	-	-	-	14	2,0	20

**Brick types and properties**

Brick code	Data	Brick name	Image	Size [mm]	$t_0$ [mm]	$t_1$ [mm]	a [mm]	$f_b$ [N/mm <sup>2</sup> ]	$\rho$ [kg/dm <sup>3</sup> ]	Page
<b>Hollow Normal weight concrete</b>										
HNWC1	ETA	Hollow normal weight concrete brick parpaing creux		l: 500 b: 200 h: 200	$t_{01}$ : 15 $t_{02}$ : 15	$t_{11}$ : 15 $t_{12}$ : 15	$a_1$ : 133 $a_2$ : 75	4 10	0,9	20
HNWC2	Hilti Data	Italy Blocchi Cem		l: 500 b: 200 h: 200	$t_{01}$ : 30 $t_{02}$ : 30	$t_{11}$ : 30 $t_{12}$ : --	$a_1$ : 200 $a_2$ : 135	8	1,0	21
HNWC3	Hilti Data	Germany Hbn 4		l: 365 b: 240 h: 238	$t_{01}$ : 26 $t_{02}$ : 35	$t_{11}$ : 26 $t_{12}$ : 26	$a_1$ : 128 $a_2$ : 62	4 10	1,4	21
HNWC4	Hilti Data	UK (b=215 mm)		l: 440 b: 215 h: 215	$t_{01}$ : 48 $t_{02}$ : 48	$t_{11}$ : 40 $t_{12}$ : --	$a_1$ : 150 $a_2$ : 120	10	1,2	21
HNWC5	Hilti Data	UK (b=138 mm)		l: 440 b: 138 h: 215	$t_{01}$ : 48 $t_{02}$ : 38	$t_{11}$ : 48 $t_{12}$ : --	$a_1$ : 150 $a_2$ : 60	13	1,5	21
HNWC6	Hilti Data	UK (b=112 mm)		l: 440 b: 112 h: 215	$t_{01}$ : 30 $t_{02}$ : 30	$t_{11}$ : 30 $t_{12}$ : --	$a_1$ : 50 $a_2$ : 50	7	1,3	21
HNWC7	Hilti Data	Finland Standard concrete brick		l: 600 b: 500 h: 92	$t_{01}$ : 32 $t_{02}$ : 15	$t_{11}$ : 32 $t_{12}$ : --	$a_1$ : 62 $a_2$ : 62	6	0,9	22
HNWC8	Hilti Data	Australian block system 200		l: 390 b: 190 h: 190	$t_{01}$ : 30 $t_{02}$ : 30	$t_{11}$ : 30 $t_{12}$ : --	$a_1$ : 150 $a_2$ : 130	15	1,1	22

## Anchor installation parameters

### Brick position:

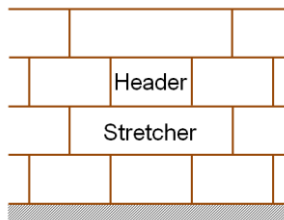

- **Header (H):** The longest dimension of the brick represents the width of the wall
- **Stretcher (S):** The longest dimension of the brick represents the length of the wall

### Spacing and edge distance:

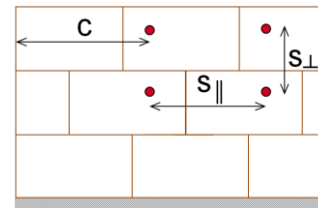

- c - Distance to the edge
- s<sub>||</sub> - Spacing parallel to the bed joint
- s<sub>⊥</sub> - Spacing perpendicular to the bed joint

### Allowed anchor positions:

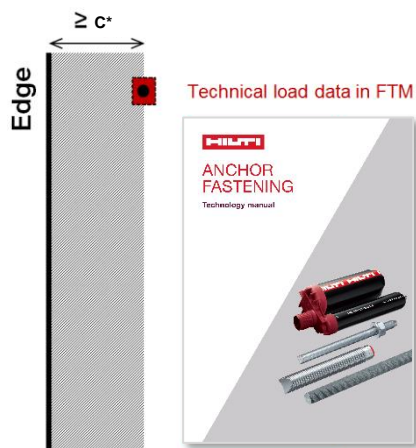

- This FTM includes the load data for single anchors in masonry with a distance to edge equal to or greater than **c\***.
- **c\*** is the distance from the anchor to the edge of the wall, such that the loading capacity of the anchor is not influenced by the edge.
- Minimum spacing between anchors = MAX (3 x h<sub>ef</sub>; size of brick in respective direction). This applies for a (conservative) manual design/calculation of a baseplate using the load tables in this manual.
- For an optimized design or cases not covered in this technical data, including anchor groups, please use PROFIS Engineering software or consult ETA-13/1036, ETA-19/0160, or ETA-22/0395.

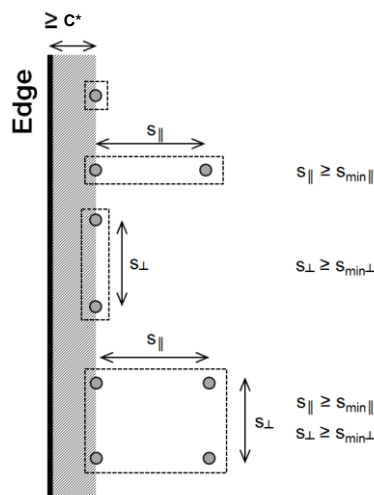

### PROFIS Engineering software interface:

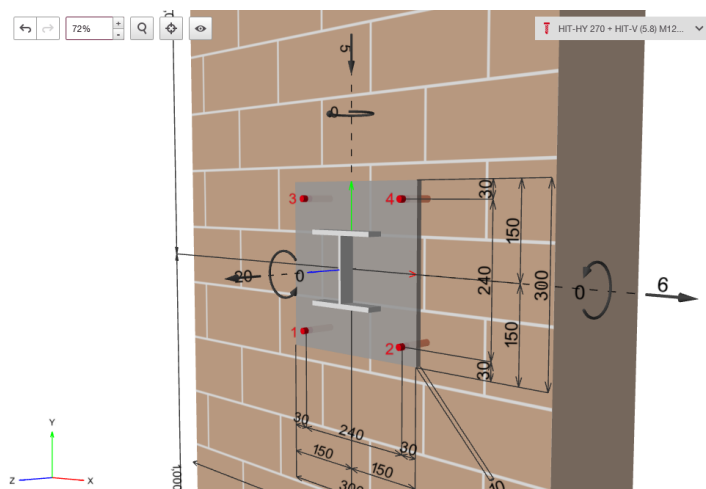

### Anchor dimensions for HIT-V and HAS-U

Anchor size		M6	M8	M10	M12	M16
Embedment depth	with HIT-SC	Variable length from 50 to 160				
	without HIT-SC	Variable length from 50 to 300*				

\* For brick types SC6 resistance for  $h_{ef}$  up to 350 mm are provided in the ETA-22/0395.

### Anchor dimensions for HIT-IC

Anchor size		M8x80	M10x80	M12x80
Embedment depth	$h_{ef}$ [mm]	80	80	80

### Design

- Anchorages are designed under the responsibility of an engineer experienced in anchorages and masonry work.
- Verifiable calculation notes and drawings are prepared taking account of the loads to be anchored. The position of the anchor is indicated on the design drawings (e.g. position of the anchor relative to supports, etc.).
- Anchorages under static or quasi-static loading and seismic loading are designed in accordance with: EOTA TR054, Design method A

### Basic loading data (for a single anchor)

The load tables provide the design resistance values for a single loaded anchor.





#### All data in this section applies to

- Edge distance  $c \geq c^*$ . For other applications, use Hilti PROFIS Engineering software.
- Correct anchor setting (see instruction for use, setting details)





Anchorages subject to:		Hilti HIT-HY 270 with HIT-V, HAS-U or HIT-IC	
		in solid bricks	in hollow bricks
Hole drilling		hammer mode	rotary mode
Use category: dry or wet structure		Category <b>d/d</b> - <b>Installation and use</b> in structures subject to <b>dry</b> , internal conditions, Category <b>w/d</b> - <b>Installation</b> in dry or <b>wet</b> substrate and <b>use</b> in structures subject to <b>dry</b> , internal conditions (except calcium silicate bricks), Category <b>w/w</b> - <b>Installation and use</b> in structures subject to dry or <b>wet</b> environmental conditions (except calcium silicate bricks).	
Installation direction	Masonry	horizontal	
Installation direction	Ceiling brick	overhead	
Temperature in the base material at installation		+5° C to +40° C	-5° C to +40° C (HIT-V or HIT-IC) 0° C to +40° C (HAS-U)
In-service temperature	Temperature range Ta:	-40 °C to +40 °C	(max. long term temperature +24 °C and max. short term temperature +40 °C)
	Temperature range Tb:	-40 °C to +80 °C	(max. long term temperature +50 °C and max. short term temperature +80 °C)

## Design – Failure modes

The design tensile resistance is the lower value of:

Failure due to tension loads		Condition
Failure of the metal part		$N_{Sd}^h \leq N_{Rd,s} = N_{Rk,s} / \gamma_{Ms}$
Pull-out failure of the anchor		$N_{Sd}^h \leq N_{Rd,p} = N_{Rk,p} / \gamma_{Mm}$
Brick breakout failure		$N_{Sd} \leq N_{Rd,b} = N_{Rk,b} / \gamma_{Mm}$ $N_{Sd}^g \leq N_{Rd}^g = N_{Rk}^g / \gamma_{Mm}$
Pull out of one brick		$N_{Sd} \leq N_{Rd,pb} = N_{Rk,pb} / \gamma_{Mm}$

The design shear resistance is the lower value of:

Failure due to shear loads		Condition
Failure of the metal part		$V_{Sd}^h \leq V_{Rd,s} = V_{Rk,s} / \gamma_{Ms}$
Local brick failure		$V_{Sd} \leq V_{Rd,b} = V_{Rk,b} / \gamma_{Mm}$ $V_{Sd}^g \leq V_{Rd}^g = V_{Rk}^g / \gamma_{Mm}$
Brick edge failure		$V_{Sd} \leq V_{Rd,c} = V_{Rk,c} / \gamma_{Mm}$ $V_{Sd}^g \leq V_{Rd}^g = V_{Rk}^g / \gamma_{Mm}$
Pushing out of one brick		$V_{Sd} \leq V_{Rd,pb} = V_{Rk,pb} / \gamma_{Mm}$

- Loads and resistances are affected by a series of factors such as visibility/filling of joints, factors for anchor groups, spacing, edge distance, embedment depth, number of brick layers.  
For deeper embedment depth, where 2 or more bricks are penetrated, see TR 054, 4.2.5.
- For other applications not covered in this FTM, use Hilti PROFIS Engineering software.

## Partial safety factors

Base material	Failure (rupture) mode - Injection Anchor ( $\gamma_{Mm}$ )
Masonry	2,5

Failure (rupture) mode - Metal part ( $\gamma_{Ms}$ )		
Tension loading	Shear loading	
	if $f_{uk} \leq 800 \text{ N/mm}^2$ and $f_{yk}/f_{uk} \leq 0,8$	if $f_{uk} > 800 \text{ N/mm}^2$ or $f_{yk}/f_{uk} > 0,8$
$1,2 / (f_{yk} / f_{uk}) \geq 1,4$	$1,0 / (f_{yk} / f_{uk}) \geq 1,25$	1,5



**Design tension and shear resistances – Steel failure for threaded rods HIT-V and HAS-U**

Anchor size		M6	M8	M10	M12	M16
N <sub>Rd,s</sub>	HIT-V 5.8 (F) HAS-U 5.8 (HDG)	6,7	12,2	19,3	28,1	52,3
	HIT-V 8.8 (F) HAS-U 8.8 (HDG)	10,7	19,5	30,9	45,0	83,7
	HIT-V-R HAS-U A4	7,5	13,7	21,7	31,6	58,8
	HIT-V-HCR HAS-U HCR	10,7	19,5	30,9	45,0	83,7
V <sub>Rd,s</sub>	HIT-V 5.8 (F) HAS-U 5.8 (HDG)	4,0	7,3	11,6	16,9	31,4
	HIT-V 8.8 (F) HAS-U 8.8 (HDG)	6,4	11,7	18,6	27,0	50,2
	HIT-V-R HAS-U A4	4,5	8,2	13,0	18,9	35,2
	HIT-V-HCR HAS-U HCR	6,4	11,7	18,6	27,0	50,2
M <sub>Rd,s</sub>	HIT-V 5.8 (F) HAS-U 5.8 (HDG)	6,4	15,2	29,6	52,8	133,6
	HIT-V 8.8 (F) HAS-U 8.8 (HDG)	9,6	24,0	48,0	84,0	212,8
	HIT-V-R HAS-U A4	7,1	16,7	33,4	59,1	149,7
	HIT-V-HCR HAS-U HCR	9,6	24,0	48,0	84,0	212,8

**Design tension and shear resistances – Steel failure for internally threaded rods HIT-IC**



Anchor size		M8	M10	M12
N <sub>Rd,s</sub>	HIT-IC [kN]	3,9	4,8	9,1
V <sub>Rd,s</sub>	HIT-V 5.8 HAS-U 5.8 [kN]	7,2	12,0	16,8
	Screw 8.8	12,0	18,4	27,2
M <sub>Rd,s</sub>	HIT-V 5.8 HAS-U 5.8 [Nm]	15,2	29,6	52,8
	Screw 8.8	24,0	48,0	84,0

**Static and quasi-static resistance (for a single anchor)**
**Design tension and shear resistances – Pull-out failure of the anchor, brick breakout failure and local brick failure at edge distance ( $c \geq c^*$ ) for single anchor applications**

Load type	Anchor size	$h_{ef}$ [mm]	$f_b$ [N/mm <sup>2</sup> ]	w/w and w/d		d/d		
				Ta	Tb	Ta	Tb	
Loads [kN]								
 <b>SC1 – Solid clay brick</b> <b>Mz, 1DF (ETA data)</b>								
$N_{Rd,p} = N_{Rd,b}$ ( $c \geq 115$ mm)	HIT-V, HAS-U      M8, M10, M12, M16	$\geq 50$	12	0,6 (0,8 <sup>a</sup> )				
			20	0,8 (1,0 <sup>a</sup> )				
			40	1,4 (1,6 <sup>a</sup> )				
	HIT-V, HAS-U      M8, M10, M12, M16 HIT-V + HIT-SC      M8, M10, M12, M16 HAS-U + HIT-SC      M8, M10, M12, M16 HIT-IC                  M8, M10, M12 HIT-IC + HIT-SC      M8, M10, M12	$\geq 80$	12	1,0 (1,2 <sup>a</sup> )				
			20	1,4 (1,6 <sup>a</sup> )				
			40	2,2 (2,6 <sup>a</sup> )				
			$\geq 100$	12	1,4 (1,6 <sup>a</sup> )			
	20	1,8 (2,0 <sup>a</sup> )						
			40	2,8 (3,2 <sup>a</sup> )				
	$V_{Rd,b}$ ( $c \geq 115$ mm)	HIT-V, HAS-U      M8, M10	$\geq 50$	12	1,0			
20				1,2				
40				1,6				
HIT-V, HAS-U      M12, M16		$\geq 50$	12	1,4				
			20	1,8				
			40	2,2				
HIT-V, HAS-U      M8, M10 HIT-V + HIT-SC      M8, M10 HAS-U + HIT-SC      M8, M10 HIT-IC                  M8 HIT-IC + HIT-SC      M8		$\geq 80$	12	2,0				
			20	2,4				
			40	3,0				
			$\geq 80$	12	2,6			
20		3,4						
40		4,2						
				40	4,2			
 <b>SC2 – Solid clay brick</b> <b>Mz, NF (ETA data)</b>								
$N_{Rd,p} = N_{Rd,b}$ ( $c \geq 50$ mm)	HIT-V, HAS-U      M8, M10, M12, M16	$\geq 50$	10	0,6 (0,6 <sup>a</sup> )				
			20	0,8 (0,8 <sup>a</sup> )				
	HIT-V, HAS-U      M8, M10, M12, M16 HIT-V + HIT-SC      M8, M10, M12, M16 HAS-U + HIT-SC      M8, M10, M12, M16	$\geq 80$	10	1,0 (1,2 <sup>a</sup> )				
			20	1,4 (1,6 <sup>a</sup> )				
$N_{Rd,p} = N_{Rd,b}$ ( $c \geq 150$ mm)	HIT-IC                  M8, M10, M12 HIT-IC + HIT-SC      M8, M10, M12	$\geq 100$	10	1,6 (1,8 <sup>a</sup> )				
			20	2,2 (2,4 <sup>a</sup> )				
$V_{Rd,b II}$ ( $c \geq 50$ mm)	HIT-V, HAS-U      M8, M10, M12, M16	$\geq 50$	10	1,2				
			20	1,8				
	HIT-V, HAS-U      M8, M10, M12, M16 HIT-V + HIT-SC      M8, M10, M12, M16 HAS-U + HIT-SC      M8, M10, M12, M16 HIT-IC                  M8, M10, M12 HIT-IC + HIT-SC      M8, M10, M12	$\geq 80$	10	1,6				

Load type	Anchor size	$h_{ef}$ [mm]	$f_b$ [N/mm <sup>2</sup> ]	w/w and w/d		d/d				
				Ta	Tb	Ta	Tb			
Loads [kN]										
$V_{Rd,b II}$ ( $c \geq 1,5 h_{ef}$ )	HIT-V, HAS-U    M8, M10, M12, M16	$\geq 50$	10			1,2				
			20			1,8				
	HIT-V, HAS-U    M8, M10 HIT-V + HIT-SC    M8, M10 HAS-U + HIT-SC    M8, M10 HIT-IC                M8 HIT-IC + HIT-SC    M8	$\geq 80$	10			2,0				
			20			2,8				
			HIT-V, HAS-U    M8, M10 HIT-V + HIT-SC    M8, M10 HAS-U + HIT-SC    M8, M10	$\geq 100$	10			3,2		
					20			4,4		
					HIT-V, HAS-U    M12, M16 HIT-V + HIT-SC    M12, M16 HAS-U + HIT-SC    M12, M16 HIT-IC                M10, M12 HIT-IC + HIT-SC    M10, M12	$\geq 80$	10			3,6
	20			4,8						
	<b>SC3 - Solid clay brick</b> <b>Mz, 2DF (ETA data)</b>									
	$N_{Rd,p} = N_{Rd,b}$ ( $c \geq 115$ mm)	HIT-V, HAS-U    M8, M10, M12, M16	$\geq 50$	12					1,0 (1,2 <sup>a</sup> )	
				20			1,0 (1,2 <sup>a</sup> )			
		HIT-V, HAS-U    M8, M10, M12, M16 HIT-V + HIT-SC    M8, M10, M12, M16 HAS-U + HIT-SC    M8, M10, M12, M16 HIT-IC                M8, M10, M12 HIT-IC + HIT-SC    M8, M10, M12	$\geq 80$	12			1,4 (1,6 <sup>a</sup> )			
20						1,8 (2,2 <sup>a</sup> )				
$\geq 100$				12			2,4 (2,8 <sup>a</sup> )			
		20			2,8 (3,2 <sup>a</sup> )					
$V_{Rd,b}$ ( $c \geq 1,5 h_{ef}$ )	HIT-V, HAS-U    M8, M10, M12, M16	$\geq 50$	12			2,2				
			20			2,8				
	HIT-V, HAS-U    M8, M10 HIT-V + HIT-SC    M8, M10 HAS-U + HIT-SC    M8, M10 HIT-IC                M8 HIT-IC + HIT-SC    M8	$\geq 80$	12			3,2				
			20			4,0				
			HIT-V, HAS-U    M12 HIT-V + HIT-SC    M12 HAS-U + HIT-SC    M12 HIT-IC                M10 HIT-IC + HIT-SC    M10	$\geq 80$	12			4,2		
					20			4,8		
	$V_{Rd,b}$ ( $c \geq 1,5 h_{ef}$ )	$\geq 80$			12			4,8		
					20			4,8		









Load type	Anchor size	$h_{ef}$ [mm]	$f_b$ [N/mm <sup>2</sup> ]	w/w and w/d		d/d	
				Ta	Tb	Ta	Tb
Loads [kN]							
 <b>SC4 - Solid clay brick</b> <b>UK London yellow Multi Stock (Hilti data)</b>							
$N_{Rd,p} = N_{Rd,b}$ ( $c \geq 100$ mm)	HIT-V + HIT-SC	M8, M10, M12, M16	$\geq 50$	16	1,4 (1,6 <sup>a</sup> )		
	HAS-U + HIT-SC	M8, M10, M12, M16			2,2 (2,6 <sup>a</sup> )		
	HIT-V + HIT-SC	M8, M10	$\geq 80$		2,6 (3,0 <sup>a</sup> )		
HAS-U + HIT-SC	M8, M10						
HIT-IC + HIT-SC	M8, M10, M12						
$V_{Rd,b}$ ( $c \geq 1,5 h_{ef}$ )	HIT-V + HIT-SC	M8, M10	$\geq 50$		16	2,6	
	HAS-U + HIT-SC	M8, M10		3,2			
	HIT-V + HIT-SC	M12, M16	$\geq 80$	3,2			
	HAS-U + HIT-SC	M12, M16		4,8			
	HIT-IC + HIT-SC	M8, M10, M12					
 <b>SC5 - Solid clay brick</b> <b>AUS Common dry pressed (Hilti data)</b>							
$N_{Rd,p} = N_{Rd,b}$ ( $c \geq 110$ mm)	HIT-V, HAS-U	M8, M10, M12	80	25	2,6 (3,0 <sup>a</sup> )		
$V_{Rd,b II}$ ( $c \geq 110$ mm)	HIT-V, HAS-U	M8, M10	80	25	3,8		
	HIT-IC	M8			4,8		
	HIT-V, HAS-U	M12					
 <b>SC6 – Rosso Classico, Rosso Vivo (ETA data)<sup>a,b</sup></b>							
$N_{Rd,p} = N_{Rd,b}$ ( $c \geq 150$ mm)	Rebar $\emptyset$	8	100	18	2,4		2,4
			200		3,8		4,0
	Rebar $\emptyset$	12	50		0,24		0,24
$V_{Rd,b II}$ ( $c \geq 150$ mm)	HIT-V, HAS-U	M12	300	18	5,2		5,6
	Rebar $\emptyset$	8	100		1,1		
	Rebar $\emptyset$	12					
	HIT-V, HAS-U	M12					



a) Compressed Air Cleaning only

b) Linear interpolation for intermediate embedment depth values, according to ETA-22/0395.

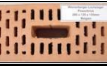
**Design tension and shear resistances – Pull-out failure of the anchor, brick breakout failure and local brick failure at edge distance ( $c \geq c^*$ ) for single anchor applications**



Load type	Anchor size	$h_{ef}$ [mm]	$f_b$ [N/mm <sup>2</sup> ]	w/w and w/d		d/d		
				Ta	Tb	Ta	Tb	
Loads [kN]								
 <b>HC1 - Hollow clay brick</b> Hz, 10DF (ETA data)								
$N_{Rd,p} = N_{Rd,b}$ ( $c \geq 150$ mm)	HIT-V + HIT-SC	M8, M10, M12, M16	≥ 80	12	2,2 (2,4 <sup>a</sup> )			
	HAS-U + HIT-SC	M8, M10, M12, M16			20	2,8 (3,2 <sup>a</sup> )		
	HIT-IC + HIT-SC	M8, M10, M12						
$V_{Rd,b II}$ ( $c \geq 300$ mm)	HIT-V + HIT-SC	M8, M10	≥ 80	12	1,8			
	HAS-U + HIT-SC	M8, M10		20	2,2			
	HIT-IC + HIT-SC	M8						
	HIT-V + HIT-SC	M12, M16		12	3,8			
	HAS-U + HIT-SC	M12, M16		20	4,0			
HIT-IC + HIT-SC	M10, M12							
 <b>HC2 - Hollow clay brick</b> Italy Mattone Alveolater 50 (Hilti data)								
$N_{Rd,p} = N_{Rd,b}$ ( $c \geq 50$ mm)	HIT-V + HIT-SC	M8, M10, M12, M16	≥ 80	16	1,8 (2,0 <sup>a</sup> )			
	HAS-U + HIT-SC	M8, M10, M12, M16						
	HIT-IC + HIT-SC	M8, M10, M12						
	HIT-V + HIT-SC	M8, M10, M12, M16	≥ 130		2,6 (3,0 <sup>a</sup> )			
HAS-U + HIT-SC	M8, M10, M12, M16							
$V_{Rd,b}$ ( $c \geq 150$ mm)	HIT-V + HIT-SC	M8, M10, M12, M16	≥ 80	16	1,4			
	HAS-U + HIT-SC	M8, M10, M12, M16						
	HIT-IC + HIT-SC	M8, M10, M12						
	HIT-V + HIT-SC	M8, M10, M12, M16	≥ 130		2,6			
HAS-U + HIT-SC	M8, M10, M12, M16							
 <b>HC3 - Hollow clay brick</b> Spain Termoarcilla (Hilti data)								
$N_{Rd,p} = N_{Rd,b}$ ( $c_{cr} = 50$ mm)	HIT-V + HIT-SC	M8, M10, M12, M16	≥ 50	22	0,6 (0,8 <sup>a</sup> )			
	HAS-U + HIT-SC	M8, M10, M12, M16						
	HIT-V + HIT-SC	M8, M10, M12, M16	≥ 80		1,0 (1,2 <sup>a</sup> )			
	HAS-U + HIT-SC	M8, M10, M12, M16						
HIT-IC + HIT-SC	M8, M10, M12							
$V_{Rd,b}$ ( $c \geq 150$ mm)	HIT-V + HIT-SC	M8, M10, M12, M16	≥ 50	22	1,8			
	HAS-U + HIT-SC	M8, M10, M12, M16						
	HIT-IC + HIT-SC	M8, M10, M12						
 <b>HC4 - Hollow clay brick</b> Belgium Wienerberger Thermobrick (Hilti data)								
$N_{Rd,p} = N_{Rd,b}$ ( $c \geq 150$ mm)	HIT-V + HIT-SC	M8, M10, M12, M16	≥ 50	21	0,5 (0,6 <sup>a</sup> )			
	HAS-U + HIT-SC	M8, M10, M12, M16						
	HIT-V + HIT-SC	M8, M10, M12, M16	≥ 80		2,2 (2,6 <sup>a</sup> )			
	HAS-U + HIT-SC	M8, M10, M12, M16						
HIT-IC + HIT-SC	M8, M10, M12							
$V_{Rd,b}$ ( $c \geq 150$ mm)	HIT-V + HIT-SC	M8, M10	≥ 50	21	2,4			
	HAS-U + HIT-SC	M8, M10						
	HIT-V + HIT-SC	M12, M16						
	HAS-U + HIT-SC	M12, M16						
HIT-IC + HIT-SC	M8, M10, M12							

Load type	Anchor size	$h_{ef}$ [mm]	$f_b$ [N/mm <sup>2</sup> ]	w/w and w/d		d/d	
				Ta	Tb	Ta	Tb
Loads [kN]							
 <b>HC5 - Hollow clay brick</b> <b>Spain Hueco doble (Hilti data)</b>							
$N_{Rd,p} = N_{Rd,b}$ ( $c \geq 120$ mm)	HIT-V + HIT-SC	M8, M10, M12, M16	$\geq 50$	4	0,4		
	HAS-U + HIT-SC	M8, M10, M12, M16					
	HIT-V + HIT-SC	M8	80		0,8 (1,0 <sup>a</sup> )		
	HAS-U + HIT-SC	M8					
	HIT-V + HIT-SC	M10			1,0 (1,2 <sup>a</sup> )		
HAS-U + HIT-SC	M10						
HIT-IC + HIT-SC	M8, M10, M12	M12, M16	1,4 (1,6 <sup>a</sup> )				
HIT-V + HIT-SC	M12, M16						
HAS-U + HIT-SC	M12, M16						
$V_{Rd,b}$ ( $c \geq 120$ mm)	HIT-V + HIT-SC	M8, M10, M12, M16	$\geq 50$	4	1,2		
 <b>HC6 - Hollow clay brick</b> <b>Belgium Wienerberger Powerbrick (Hilti data)</b>							
$N_{Rd,p} = N_{Rd,b}$ ( $c \geq 50$ mm)	HIT-V + HIT-SC	M8, M10, M12, M16	$\geq 50$	41	1,6 (1,8 <sup>a</sup> )		
	HAS-U + HIT-SC	M8, M10, M12, M16					
	HIT-V + HIT-SC	M8, M10, M12, M16	$\geq 80$		2,6 (2,8 <sup>a</sup> )		
	HAS-U + HIT-SC	M8, M10, M12, M16					
HIT-IC + HIT-SC	M8, M10, M12						
$V_{Rd,b}$ ( $c \geq 150$ mm)	HIT-V + HIT-SC	M8, M10	$\geq 50$	41	2,6		
	HAS-U + HIT-SC	M8, M10					
	HIT-V + HIT-SC	M12, M16			4,8		
	HAS-U + HIT-SC	M12, M16					
HIT-IC + HIT-SC	M8, M10, M12						
 <b>HC7 - Hollow clay brick</b> <b>Italy Doppio uni (Hilti data)</b>							
$N_{Rd,p} = N_{Rd,b}$ ( $c \geq 50$ mm)	HIT-V + HIT-SC	M8, M10, M12, M16	$\geq 50$	27	0,6		
	HAS-U + HIT-SC	M8, M10, M12, M16					
	HIT-V + HIT-SC	M8, M10, M12, M16	$\geq 80$		1,0 (1,2 <sup>a</sup> )		
	HAS-U + HIT-SC	M8, M10, M12, M16					
	HIT-IC + HIT-SC	M8, M10, M12	$\geq 130$		2,8 (3,2 <sup>a</sup> )		
HIT-V + HIT-SC	M8, M10, M12, M16						
HAS-U + HIT-SC	M8, M10, M12, M16						
$V_{Rd,b}$ ( $c \geq 150$ mm)	HIT-V + HIT-SC	M8, M10, M12, M16	$\geq 50$	27	1,6		
	HAS-U + HIT-SC	M8, M10, M12, M16					
	HIT-V + HIT-SC	M8, M10, M12, M16	$\geq 80$		3,6		
	HAS-U + HIT-SC	M8, M10, M12, M16					
HIT-IC + HIT-SC	M8, M10, M12						
 <b>HC8 - Hollow clay brick</b> <b>Spain Ladrillo cara vista (Hilti data)</b>							
$N_{Rd,p} = N_{Rd,b}$ ( $c \geq 115$ mm)	HIT-V + HIT-SC	M8, M10, M12, M16	$\geq 50$	42	0,6 (0,8 <sup>a</sup> )		
	HAS-U + HIT-SC	M8, M10, M12, M16					
	HIT-V + HIT-SC	M8, M10, M12, M16	$\geq 80$		2,2 (2,6 <sup>a</sup> )		
	HAS-U + HIT-SC	M8, M10, M12, M16					
HIT-IC + HIT-SC	M8, M10, M12						
$V_{Rd,b}$ ( $c \geq 115$ mm)	HIT-V + HIT-SC	M8, M10, M12, M16	$\geq 50$	42	1,8		
	HAS-U + HIT-SC	M8, M10, M12, M16					
	HIT-IC + HIT-SC	M8, M10, M12					

Load type	Anchor size	$h_{ef}$ [mm]	$f_b$ [N/mm <sup>2</sup> ]	w/w and w/d		d/d	
				Ta	Tb	Ta	Tb
Loads [kN]							
 <b>HC9 - Hollow clay brick</b> <b>Spain Clinker mediterraneo (Hilti data)</b>							
$N_{Rd,p} = N_{Rd,b}$ (c ≥ 115mm)	HIT-V + HIT-SC	M8, M10, M12, M16	≥ 50	78	0,6 (0,8 <sup>a</sup> )		
	HAS-U + HIT-SC	M8, M10, M12, M16	≥ 80		2,0 (2,2 <sup>a</sup> )		
	HIT-V + HIT-SC	M8, M10, M12, M16	≥ 80				
	HAS-U + HIT-SC	M8, M10, M12, M16					
$V_{Rd,b}$ (c ≥ 115 mm)	HIT-V + HIT-SC	M8, M10, M12, M16	≥ 50	78	2,0		
	HAS-U + HIT-SC	M8, M10, M12, M16	≥ 80				
	HIT-IC + HIT-SC	M8, M10, M12	≥ 80				
 <b>HC10 Hollow clay brick</b> <b>UK Nostell Red Multi (Hilti data)</b>							
$N_{Rd,p} = N_{Rd,b}$ (c ≥ 105 mm)	HIT-V + HIT-SC	M8, M10, M12, M16	≥ 50	70	2,4 (2,8 <sup>a</sup> )		
	HAS-U + HIT-SC	M8, M10, M12, M16	≥ 80		2,8 (3,2 <sup>a</sup> )		
	HIT-V + HIT-SC	M8, M10, M12, M16	≥ 80				
	HAS-U + HIT-SC	M8, M10, M12, M16					
$V_{Rd,b}$ (c ≥ 105 mm)	HIT-V + HIT-SC	M8, M10, M12, M16	≥ 50	70	4,6		
	HAS-U + HIT-SC	M8, M10, M12, M16	≥ 80		4,8		
	HIT-V + HIT-SC	M8, M10, M12, M16	≥ 80				
	HAS-U + HIT-SC	M8, M10, M12, M16					
 <b>HC11 Hollow clay brick</b> <b>AUS Common standard (Hilti data)</b>							
$N_{Rd,p} = N_{Rd,b}$ (c ≥ 110 mm)	HIT-V + HIT-SC	M8, M10, M12, M16	≥ 50	84	0,6 (0,8 <sup>a</sup> )		
	HAS-U + HIT-SC	M8, M10, M12, M16	≥ 80		2,6 (3,0 <sup>a</sup> )		
	HIT-V + HIT-SC	M8, M10	≥ 80				
	HAS-U + HIT-SC	M8, M10					
	HIT-V + HIT-SC	M12, M16	≥ 80				
	HAS-U + HIT-SC	M12, M16					
$V_{Rd,b II}$ (c ≥ 110 mm)	HIT-V + HIT-SC	M8, M10	≥ 50	84	2,0		
	HAS-U + HIT-SC	M8, M10	≥ 80		2,8		
	HIT-V + HIT-SC	M12, M16	≥ 80				
	HAS-U + HIT-SC	M12, M16					
	HIT-V + HIT-SC	M16	≥ 80				
	HAS-U + HIT-SC	M16					
HIT-IC + HIT-SC	M8, M10, M12	≥ 80	3,8				

a) Compressed Air Cleaning only



**Design tension and shear resistances – Pull-out failure of the anchor, brick breakout failure and local brick failure at edge distance ( $c \geq c^*$ ) for single anchor applications**



Load type	Anchor size	$h_{ef}$ [mm]	$f_b$ [N/mm <sup>2</sup> ]	w/w and w/d		d/d	
				Ta	Tb	Ta	Tb
Loads [kN]							
	<b>CC1 - Ceiling Hollow clay brick</b> "Ds-1,0" (ETA data)						
$N_{Rd,p} = N_{Rd,b}$ ( $c \geq 100$ mm)	HIT-V + HIT-SC M6 HAS-U + HIT-SC M6	$\geq 80$	3	0,6			
	<b>CC2 - Ceiling Hollow clay brick</b> Italy Mattone rosso (Hilti data)						
$N_{Rd,p} = N_{Rd,b}$ ( $c \geq 100$ mm)	HIT-V + HIT-SC M6, M8, M10, M12 HAS-U + HIT-SC M6, M8, M10, M12 HIT-IC + HIT-SC M8, M10, M12	$\geq 80$	3	0,6			
	<b>SCS1 - Solid silica brick</b> KS, 2DF (ETA data)						
$N_{Rd,p} = N_{Rd,b}$ ( $c \geq 115$ mm)	HIT-V, HAS-U M8, M10, M12, M16	$\geq 80$	26	0,6			
$N_{Rd,p} = N_{Rd,b}$ ( $c \geq 115$ mm) $V_{Rd,b II}$ ( $c \geq 115$ mm)	HIT-V, HAS-U M8, M10, M12, M16	$\geq 50$	12	-	2,4	2,0	
	HIT-V, HAS-U M8, M10, M12, M16 HIT-V + HIT-SC M8, M10, M12, M16 HAS-U + HIT-SC M8, M10, M12, M16 HIT-IC M8, M10, M12 HIT-IC + HIT-SC M8, M10, M12		28	-	3,6	3,0	
	HIT-V, HAS-U M8, M10, M12, M16 HIT-V + HIT-SC M8, M10, M12, M16 HAS-U + HIT-SC M8, M10, M12, M16 HIT-IC M8, M10, M12 HIT-IC + HIT-SC M8, M10, M12	$\geq 80$	12	-	2,4	2,0	
	HIT-V, HAS-U M8, M10, M12, M16 HIT-V + HIT-SC M8, M10, M12, M16 HAS-U + HIT-SC M8, M10, M12, M16 HIT-IC M8, M10, M12 HIT-IC + HIT-SC M8, M10, M12		28	-	3,6	3,0	
	$V_{Rd,b II}$ ( $c \geq 115$ mm)	HIT-V, HAS-U M8, M10, M12, M16 HIT-V, HAS-U M8, M10, M12, M16 HIT-V + HIT-SC M8, M10, M12, M16 HAS-U + HIT-SC M8, M10, M12, M16 HIT-IC M8, M10, M12 HIT-IC + HIT-SC M8, M10, M12	$\geq 50$	12	-	2,4	
		HIT-V, HAS-U M8, M10, M12, M16 HIT-V + HIT-SC M8, M10, M12, M16 HAS-U + HIT-SC M8, M10, M12, M16 HIT-IC M8, M10, M12 HIT-IC + HIT-SC M8, M10, M12		28	-	3,6	
		HIT-V, HAS-U M8, M10, M12, M16 HIT-V + HIT-SC M8, M10, M12, M16 HAS-U + HIT-SC M8, M10, M12, M16 HIT-IC M8, M10, M12 HIT-IC + HIT-SC M8, M10, M12	$\geq 80$	12	-	2,4	
		HIT-V, HAS-U M8, M10, M12, M16 HIT-V + HIT-SC M8, M10, M12, M16 HAS-U + HIT-SC M8, M10, M12, M16 HIT-IC M8, M10, M12 HIT-IC + HIT-SC M8, M10, M12					

Load type	Anchor size	$h_{ef}$ [mm]	$f_b$ [N/mm <sup>2</sup> ]	w/w and w/d		d/d		
				Ta	Tb	Ta	Tb	
				Loads [kN]				
<b>SCS2- Solid silica brick</b> <b>KS, 8DF (ETA data)</b>								
$N_{Rd,p} = N_{Rd,b}$ ( $c \geq 120$ mm)	HIT-V, HAS-U	M8, M10, M12, M16	$\geq 50$	12	-		2,8	2,2
				20	-		3,6	3,0
				28	-		4,2	3,4
	HIT-V, HAS-U	M8, M10	$\geq 80$	12	-		3,4	2,8
				20	-		4,4	3,6
				28	-		4,8	4,2
	HIT-V, HAS-U HIT-V + HIT-SC HAS-U + HIT-SC HIT-IC HIT-IC + HIT-SC	M12 M8, M10 M8, M10 M8, M10 M8	$\geq 80$	12	-		4,6	3,8
				$\geq 20$	-		4,8	
				$\geq 12$	-		4,8	
					-		4,8	
					-		4,8	
	HIT-V, HAS-U	M8, M10	$\geq 100$	12	-		4,8	4,4
				$\geq 20$	-		4,8	
				$\geq 12$	-		4,8	
	$V_{Rd,b II}$ ( $c \geq 120$ mm)	HIT-V, HAS-U	M8, M10	$\geq 50$	12	-		3,6
$\geq 50$				$\geq 20$	-		4,8	
HIT-V, HAS-U HIT-V + HIT-SC HAS-U + HIT-SC HIT-IC HIT-IC + HIT-SC		M12, M16 M8, M10, M12, M16 M8, M10, M12, M16 M8, M10, M12 M8, M10, M12	$\geq 80$	$\geq 50$	$\geq 12$	-		4,8
				$\geq 80$	$\geq 12$	-		4,8
				$\geq 80$	$\geq 12$	-		4,8
<b>HCS1 - Hollow silica brick</b> <b>KSL, 8DF (ETA data)</b>								
$N_{Rd,p} = N_{Rd,b}$ ( $c \geq 50$ mm)	HIT-V + HIT-SC HAS-U + HIT-SC HIT-IC + HIT-SC	M8, M10, M12, M16 M8, M10, M12, M16 M8, M10, M12	$\geq 80$	12	-	-	1,6	1,2
				20	-	-	2,2	1,8
	HIT-V + HIT-SC HAS-U + HIT-SC	M8, M10, M12, M16 M8, M10, M12, M16	$\geq 130$	12	-	-	2,0	1,6
				20	-	-	3,0	2,4
$V_{Rd,b II}$ ( $c \geq 125$ mm)	HIT-V + HIT-SC HAS-U + HIT-SC	M8 M8	$\geq 80$	12	-		2,4	
				20	-		3,6	
	HIT-V + HIT-SC HAS-U + HIT-SC HIT-IC + HIT-SC	M10 M10 M8		12	-		3,6	
				20	-		4,8	
	HIT-V + HIT-SC HAS-U + HIT-SC HIT-IC + HIT-SC	M12, M16 M12, M16 M10, M12		12	-		4,8	
				20	-		4,8	
<b>HCS2 - Hollow silica brick</b> <b>Germany KSL, 3DF (Hilti data)</b>								
$N_{Rd,p} = N_{Rd,b}$ ( $c \geq 50$ mm)	HIT-V + HIT-SC HAS-U + HIT-SC HIT-IC + HIT-SC	M8, M10, M12, M16 M8, M10, M12, M16 M8, M10, M12	$\geq 80$	12	-	-	2,0	1,6
$V_{Rd,b}$ ( $c \geq 120$ mm)	HIT-V + HIT-SC HAS-U + HIT-SC HIT-IC + HIT-SC	M8, M10, M12, M16 M8, M10, M12, M16 M8, M10, M12	$\geq 80$	12			2,0	

a) Compressed Air Cleaning only



**Design tension and shear resistances – Pull-out failure of the anchor, brick breakout failure and local brick failure at edge distance ( $c \geq c^*$ ) for single anchor applications**

Load type	Anchor size	$h_{ef}$ [mm]	$f_b$ [N/mm <sup>2</sup> ]	w/w and w/d		d/d	
				Ta	Tb	Ta	Tb
Loads [kN]							
 <b>SLWC1 - Solid lightweight concrete brick</b> Vbl, 2DF (ETA data)							
$N_{Rd,p} = N_{Rd,b}$ ( $c \geq 115$ mm)	HIT-V, HAS-U M8, M10, M12, M16	$\geq 50$	4	1,2	0,8	1,2 (1,4 <sup>a</sup> )	1,0
			6	1,4	1,2	1,6	1,2 (1,4 <sup>a</sup> )
	HIT-V, HAS-U M8, M10, M12, M16 HIT-V + HIT-SC M8, M10, M12, M16	$\geq 80$	4	1,8	1,4	2,0	1,6 (1,8 <sup>a</sup> )
			6	2,2	1,8	2,4 (2,6 <sup>a</sup> )	2,0 (2,2 <sup>a</sup> )
	HAS-U + HIT-SC M8, M10, M12, M16 HIT-IC M8, M10, M12	$\geq 100$	4	2,4	2,0	2,6 (2,8 <sup>a</sup> )	2,2 (2,4 <sup>a</sup> )
6			3,0	2,4	3,2 (3,4 <sup>a</sup> )	2,6 (2,8 <sup>a</sup> )	
$V_{Rd,b II}$ ( $c \geq 115$ mm)	HIT-V, HAS-U M8, M10, M12, M16	$\geq 50$	4	0,8			
			6	1,0			
	HIT-V, HAS-U M10, M12, M16 HIT-V + HIT-SC M8, M10, M12, M16	$\geq 80$	4	1,0			
			6	1,2			
	HIT-IC M8, M10, M12						
HIT-IC + HIT-SC M8, M10, M12							
 <b>SLWC2 - Solid lightweight concrete brick</b> Sweden Leca typ 3 (Hilti data)							
$N_{Rd,p} = N_{Rd,b}$ ( $c \geq 115$ mm)	HIT-V + HIT-SC M8, M10, M12, M16	$\geq 80$	3	2,2	1,8	2,4 (2,6 <sup>a</sup> )	2,0 (2,2 <sup>a</sup> )
	HAS-U + HIT-SC M8, M10, M12, M16						
	HIT-IC + HIT-SC M8, M10, M12						
$V_{Rd,b}$ ( $c \geq 115$ mm)	HIT-V + HIT-SC M8, M10, M12, M16	$\geq 80$	3	1,6			
	HAS-U + HIT-SC M8, M10, M12, M16						
	HIT-IC + HIT-SC M8, M10, M12			1,0			
 <b>SLWC3 - Solid lightweight concrete brick</b> Italy "Tufo" volcanic rock (Hilti data)							
$N_{Rd,p} = N_{Rd,b}$ ( $c \geq 115$ mm)	HIT-V, HAS-U M8	$\geq 80$	4	1,2	1,0	1,4	1,2
	HIT-V, HAS-U M10			1,6	1,2	1,8	1,4 (1,6 <sup>a</sup> )
	HIT-V, HAS-U M12			1,8	1,6	2,0	1,8
	HIT-V, HAS-U M16			2,2	1,8	2,4 (2,6 <sup>a</sup> )	2,0 (2,2 <sup>a</sup> )
$V_{Rd,b}$ ( $c \geq 115$ mm)	HIT-V, HAS-U M8	$\geq 80$	4	0,8			
	HIT-V, HAS-U M10, M12, M16			1,8			
 <b>HLWC1 - Hollow lightweight concrete brick</b> Hbl, 16DF (ETA data)							
$N_{Rd,p} = N_{Rd,b}$ ( $c \geq 125$ mm)	HIT-V + HIT-SC M8, M10	$\geq 80$	2	1,4	1,2	1,6	1,2 (1,4 <sup>a</sup> )
	HAS-U + HIT-SC M8, M10			2,4	2,0	2,6 (2,8 <sup>a</sup> )	2,2 (2,4 <sup>a</sup> )
	HIT-IC + HIT-SC M8						
	HIT-V + HIT-SC M12, M16	$\geq 80$	2	1,6	1,4	1,8	1,4 (1,6 <sup>a</sup> )
	HAS-U + HIT-SC M12, M16			2,8	2,4	3,2	2,6 (2,8 <sup>a</sup> )
	HIT-IC + HIT-SC M10, M12						
$V_{Rd,b}$ ( $c \geq 250$ mm)	HIT-V + HIT-SC M8, M10	$\geq 80$	2	1,6			
	HAS-U + HIT-SC M8, M10			2,6			
	HIT-IC + HIT-SC M8						
	HIT-V + HIT-SC M12			2,2			
	HAS-U + HIT-SC M12			3,8			
	HIT-IC + HIT-SC M10						
HIT-V + HIT-SC M16	$\geq 80$	2	2,4				
HAS-U + HIT-SC M16							
HIT-IC + HIT-SC M12			4,0				



Load type	Anchor size	$h_{ef}$ [mm]	$f_b$ [N/mm <sup>2</sup> ]	w/w and w/d		d/d		
				Ta	Tb	Ta	Tb	
Loads [kN]								
 <b>HLWC2 - Hollow lightweight concrete brick</b> Germany - Hbl 2, 10DF (Hilti data)								
$N_{Rd,p} = N_{Rd,b}$ (c ≥ 50 mm)	HIT-V + HIT-SC	M8, M10, M12, M16	≥ 80	2	0,6	0,5	0,6	0,5 (0,6 <sup>a</sup> )
	HAS-U + HIT-SC	M8, M10, M12, M16						
	HIT-IC + HIT-SC	M8, M10, M12						
$V_{Rd,b}$ (c ≥ 250 mm)	HIT-V + HIT-SC	M8, M10, M12, M16	≥ 80	2	0,6			
	HAS-U + HIT-SC	M8, M10, M12, M16						
	HIT-IC + HIT-SC	M8, M10, M12						
 <b>HLWC3 - Hollow lightweight concrete brick</b> Germany - Hbl 4, 8DF (Hilti data)								
$N_{Rd,p} = N_{Rd,b}$ (c ≥ 50 mm)	HIT-V + HIT-SC	M8, M10, M12, M16	≥ 80	4	0,6	0,6	0,8	0,6
	HAS-U + HIT-SC	M8, M10, M12, M16						
	HIT-IC + HIT-SC	M8, M10, M12						
$V_{Rd,b}$ (c ≥ 250 mm)	HIT-V + HIT-SC	M8, M10, M12, M16	≥ 80	4	1,4			
	HAS-U + HIT-SC	M8, M10, M12, M16						
	HIT-IC + HIT-SC	M8, M10, M12						

a) Compressed Air Cleaning only

**Design tension and shear resistances – Pull-out failure of the anchor, brick breakout failure and local brick failure at edge distance (c ≥ c\*) for single anchor applications**





 <b>SNWC1 - Solid normal weight concrete brick</b> Vbn, 2DF (ETA data)								
$N_{Rd,p} = N_{Rd,b}$ (c ≥ 115 mm)	HIT-V, HAS-U	M8, M10, M12, M16	≥ 80 <sup>b)</sup>	6	1,2	1,0	1,2	1,0
	HIT-V + HIT-SC	M8, M10, M12, M16						
	HAS-U + HIT-SC	M8, M10, M12, M16						
	HIT-IC	M8, M10, M12						
	HIT-IC + HIT-SC	M8, M10, M12						
$V_{Rd,b}$ (c ≥ 115 mm)	HIT-V, HAS-U	M8, M10, M12, M16	≥ 80 <sup>b)</sup>	6	1,6			
	HIT-V + HIT-SC	M8, M10, M12, M16						
	HAS-U + HIT-SC	M8, M10, M12, M16						
	HIT-IC	M8, M10, M12						
	HIT-IC + HIT-SC	M8, M10, M12						
 <b>SNWC2 - Solid normal weight concrete brick</b> UK Dense concrete b=100 mm (Hilti data)								
$N_{Rd,p} = N_{Rd,b}$ (c ≥ 115 mm)	HIT-V, HAS-U	M8, M10, M12, M16	50	14	2,2	1,8	2,2	1,8
	HIT-V + HIT-SC	M8, M10, M12, M16						
	HAS-U + HIT-SC	M8, M10, M12, M16						
$V_{Rd,b}$ (c ≥ 115 mm)	HIT-V, HAS-U	M8, M10, M12, M16	50	14	4,2			
	HIT-V + HIT-SC	M8, M10, M12, M16						
	HAS-U + HIT-SC	M8, M10, M12, M16						



Load type	Anchor size	$h_{ef}$ [mm]	$f_b$ [N/mm <sup>2</sup> ]	w/w and w/d		d/d		
				Ta	Tb	Ta	Tb	
Loads [kN]								
 <b>SNWC3 - Solid normal weight concrete brick</b> <b>UK Dense concrete b=140 mm (Hilti data)</b>								
$N_{Rd,p} = N_{Rd,b}$ (c ≥ 115 mm)	HIT-V, HAS-U	M8, M10, M12, M16	≥ 50	14	2,2	1,8	2,2	1,8
	HIT-V + HIT-SC	M8, M10, M12, M16						
	HAS-U + HIT-SC	M8, M10, M12, M16						
	HIT-IC	M8, M10, M12						
	HIT-IC + HIT-SC	M8, M10, M12						
$V_{Rd,b}$ (c ≥ 115 mm)	HIT-V, HAS-U	M8, M10, M12, M16	50	14	4,2			
	HIT-V + HIT-SC	M8, M10, M12, M16						
	HAS-U + HIT-SC	M8, M10, M12, M16						
	HIT-V, HAS-U	M8, M10	80		4,2			
	HIT-V + HIT-SC	M8, M10						
	HAS-U + HIT-SC	M8, M10						
	HIT-V, HAS-U	M12, M16			4,8			
	HIT-V + HIT-SC	M12, M16						
	HAS-U + HIT-SC	M12, M16						
	HIT-IC	M8, M10, M12						
HIT-IC + HIT-SC	M8, M10, M12							
 <b>HNWC1 - Hollow normal weight concrete brick</b> <b>Parpaing creux (ETA data)</b>								
$N_{Rd,p} = N_{Rd,b}$ (c ≥ 50 mm)	HIT-V + HIT-SC	M8, M10, M12, M16	≥ 50	4	0,36	0,36	0,36	0,36
	HAS-U + HIT-SC	M8, M10, M12, M16		10	0,8	0,6	0,8	0,6
	HIT-IC + HIT-SC	M8, M10, M12	≥ 130	4	0,6	0,5	0,6	0,5
	HIT-V + HIT-SC	M8, M10, M12, M16		10	1,0	0,8	1,0	0,8
	HAS-U + HIT-SC	M8, M10, M12, M16						
$V_{Rd,b}$ (c ≥ 200 mm)	HIT-V + HIT-SC	M8, M10, M12, M16	≥ 50	4	1,6			
	HAS-U + HIT-SC	M8, M10, M12, M16		10	2,6			
	HIT-V + HIT-SC	M8, M10, M12, M16	≥ 80	4	2,0			
	HAS-U + HIT-SC	M8, M10, M12, M16		10	3,0			
	HIT-IC + HIT-SC	M8, M10, M12						

- a) Compressed Air Cleaning only  
 b) ≥ 50 mm for HIT-V without HIT-SC

**Design tension and shear resistances – Pull-out failure of the anchor, brick breakout failure and local brick failure at edge distance ( $c \geq c^*$ ) for single anchor applications**

Load type	Anchor size	$h_{ef}$ [mm]	$f_b$ [N/mm <sup>2</sup> ]	w/w and w/d		d/d		
				Ta	Tb	Ta	Tb	
				Loads [kN]				
 <b>HNWC2 - Hollow normal weight concrete brick Italy Blocchi Cem (Hilti data)</b>								
$N_{Rd,p} = N_{Rd,b}$ ( $c \geq 50$ mm)	HIT-V + HIT-SC	M8, M10, M12, M16	$\geq 50$	8	1,0	0,8	1,0	0,8
	HAS-U + HIT-SC	M8, M10, M12, M16						
	HIT-IC + HIT-SC	M8, M10, M12						
$V_{Rd,b}$ ( $c \geq 200$ mm)	HIT-V + HIT-SC	M8, M10	$\geq 50$	8	4,0			
	HAS-U + HIT-SC	M8, M10						
	HIT-IC + HIT-SC	M8						
	HIT-V + HIT-SC	M12, M16			4,4			
	HAS-U + HIT-SC	M12, M16						
	HIT-IC + HIT-SC	M10, M12						
 <b>HNWC3 - Hollow normal weight concrete brick Germany Hbn 4, 12DF (Hilti data)</b>								
$N_{Rd,p} = N_{Rd,b}$ ( $c \geq 50$ mm)	HIT-V + HIT-SC	M8, M10, M12, M16	$\geq 80$	4	0,6	0,5	0,6	0,5
	HAS-U + HIT-SC	M8, M10, M12, M16		10	1,0	0,8	1,0	0,8
	HIT-IC + HIT-SC	M8, M10, M12						
$V_{Rd,b}$ ( $c \geq 240$ mm)	HIT-V + HIT-SC	M8, M10, M12, M16	$\geq 80$	4	2,2			
	HAS-U + HIT-SC	M8, M10, M12, M16		10	3,6			
	HIT-IC + HIT-SC	M8, M10, M12						
 <b>HNWC4 - Hollow normal weight concrete brick UK (b=215 mm) (Hilti data)</b>								
$N_{Rd,p} = N_{Rd,b}$ ( $c \geq 50$ mm)	HIT-V + HIT-SC	M8	80	10	0,4	0,4	0,4	0,4
	HAS-U + HIT-SC	M8						
	HIT-V + HIT-SC	M10, M12, M16			1,0	0,8	1,0	0,8
	HAS-U + HIT-SC	M10, M12, M16						
$V_{Rd,b}$ ( $c \geq 220$ mm)	HIT-V + HIT-SC	M8	80	10	1,4			
	HAS-U + HIT-SC	M8						
	HIT-V + HIT-SC	M10			2,0			
	HAS-U + HIT-SC	M10						
	HIT-V + HIT-SC	M12, M16			2,8			
	HAS-U + HIT-SC	M12, M16						
 <b>HNWC5 - Hollow normal weight concrete brick UK (b=138 mm) (Hilti data)</b>								
$N_{Rd,p} = N_{Rd,b}$ ( $c \geq 50$ mm)	HIT-V + HIT-SC	M8	80	13	0,6	0,6	0,6	0,6
	HAS-U + HIT-SC	M8						
	HIT-V + HIT-SC	M10, M12, M16			1,0	0,8	1,0	0,8
	HAS-U + HIT-SC	M10, M12, M16						
$V_{Rd,b}$ ( $c \geq 220$ mm)	HIT-V + HIT-SC	M8	80	13	1,4			
	HAS-U + HIT-SC	M8						
	HIT-V + HIT-SC	M10			2,0			
	HAS-U + HIT-SC	M10						
	HIT-V + HIT-SC	M12, M16			2,8			
	HAS-U + HIT-SC	M12, M16						
 <b>HNWC6 - Hollow normal weight concrete brick UK (b=112 mm) (Hilti data)</b>								
$N_{Rd,p} = N_{Rd,b}$ ( $c \geq 50$ mm)	HIT-V + HIT-SC	M8	50	7	0,6	0,6	0,6	0,6
	HAS-U + HIT-SC	M8						
	HIT-V + HIT-SC	M10, M12, M16			1,0	0,8	1,0	0,8
	HAS-U + HIT-SC	M10, M12, M16						
$V_{Rd,b}$ ( $c \geq 100$ mm)	HIT-V + HIT-SC	M8	50	7	1,4			
	HAS-U + HIT-SC	M8						
	HIT-V + HIT-SC	M10			2,0			
	HAS-U + HIT-SC	M10						
	HIT-V + HIT-SC	M12, M16			2,8			
	HAS-U + HIT-SC	M12, M16						

Load type	Anchor size	$h_{ef}$ [mm]	$f_b$ [N/mm <sup>2</sup> ]	w/w and w/d		d/d	
				Ta	Tb	Ta	Tb
Loads [kN]							
<b>HNWC7 - Hollow normal weight concrete brick</b> Finland "Standard Concrete Brick" (Hilti data)							
$N_{Rd,p} = N_{Rd,b}$ (c ≥ 50 mm)	HIT-V + HIT-SC M8, M10	50	6	0,6	0,4	0,6	0,4
	HAS-U + HIT-SC M8, M10			0,8	0,6	0,8	0,6
$V_{Rd,b}$ (c ≥ 100 mm)	HIT-V + HIT-SC M8	50	6	1,0			
	HAS-U + HIT-SC M8			1,4			
	HIT-V + HIT-SC M10			1,6			
	HAS-U + HIT-SC M10			1,6			
	HIT-V + HIT-SC M12, M16						
	HAS-U + HIT-SC M12, M16						
<b>HNWC8 - Hollow normal weight concrete brick</b> AUS Block system 200 (Hilti data)							
$N_{Rd,p} = N_{Rd,b}$ (c ≥ 50 mm)	HIT-V + HIT-SC M8, M10, M12, M16	≥ 50	15	1,0	0,8	1,0	0,8
	HAS-U + HIT-SC M8, M10, M12, M16						
	HIT-IC + HIT-SC M8, M10, M12						
$V_{Rd,b}$ (c ≥ 200 mm)	HIT-V + HIT-SC M8, M10	≥ 50	15	2,0			
	HAS-U + HIT-SC M8, M10			3,2			
	HIT-V + HIT-SC M12, M16						
	HAS-U + HIT-SC M12, M16						
	HIT-IC + HIT-SC M8, M10, M12						

a) Compressed Air Cleaning only

### Design tension and shear resistance – Pull out / Pushing out of one brick failure modes

#### Pull out of one brick (tension):

$$N_{Rd,pb} = 2 \cdot l \cdot b \cdot (0,5 \cdot f_{vko} + 0,4 \cdot \sigma_d) / (2,5 \cdot 1000) \quad [\text{kN}]$$

$$N_{Rd,pb} = (2 \cdot l \cdot b \cdot (0,5 \cdot f_{vko} + 0,4 \cdot \sigma_d) + b \cdot h \cdot f_{vko}) / (2,5 \cdot 1000) \quad [\text{kN}]$$

\* this equation is applicable if the vertical joints are filled

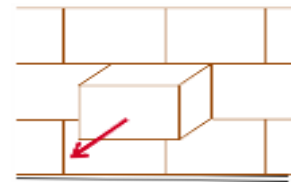

#### Pushing out of one brick (shear):

$$V_{Rd,pb} = 2 \cdot l \cdot b \cdot (0,5 \cdot f_{vko} + 0,4 \cdot \sigma_d) / (2,5 \cdot 1000) \quad [\text{kN}]$$

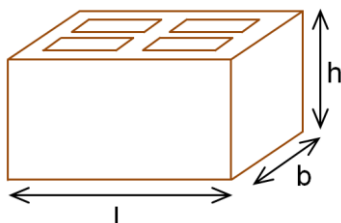
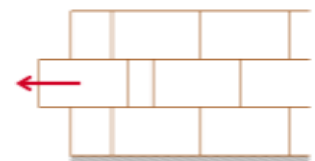

$\sigma_d$  = design compressive stress perpendicular to the shear (N/mm<sup>2</sup>)  
 $f_{vko}$  = initial shear strength according to EN 1996-1-1, Table 3.4

Brick type	Mortar strength	$f_{vko}$ [N/mm <sup>2</sup> ]
Clay brick	M2,5 to M9	0,20
	M10 to M20	0,30
All other types	M2,5 to M9	0,15
	M10 to M20	0,20

**Seismic resistance**

**Design tension and shear resistances – Pull-out failure of the anchor, brick breakout failure and local brick failure at edge distance ( $c \geq c^*$ ) for single anchor applications**

Load type	Anchor size	$h_{ef}$ [mm]	$f_b$ [N/mm <sup>2</sup> ]	w/w and w/d		d/d	
				Ta	Tb	Ta	Tb
Loads [kN]							
 <b>SC6 – Rosso Classico, Rosso Vivo (ETA data)<sup>a,b</sup></b>							
$N_{Rd,seis} =$ $N_{Rd,b,seis}$ (c ≥ 150 mm)	Rebar Ø 8	100	18	1,3		1,3	
		200		2,1		2,1	
	Rebar Ø 12 HIT-V, HAS-U M12	50		0,12		0,12	
		300		3,1		3,3	
$V_{Rd,b,seis II}$ (c ≥ 150 mm)	Rebar Ø8 8	100	18	0,6 <sup>c</sup>			
	Rebar Ø 12			0,7 <sup>c</sup>			
	HIT-V, HAS-U M12						

a) Compressed Air Cleaning only

b) Linear interpolation for intermediate embedment depth values, according to ETA-22/0395.

c) For usage of Hilti seismic filling set,  $\alpha_{gap} = 1.0$  can be applied for shear loads according to ETA-22/0395. In the given values  $\alpha_{gap} = 1.0$  was used.

**On-site tests**

For other bricks in solid or hollow masonry, not covered by the Hilti HIT-HY 270 ETA or this technical data manual, the characteristic resistance may be determined by on-site tension tests (pull-out tests or proof-load tests), according to EOTA TR053. For the evaluation of test results, the characteristic resistances shall be obtained taking into account reduction factors, which consider the different influences of the product. In case of static and quasi-static actions apply the  $\beta$ -factor and in case of seismic actions apply the factors  $\alpha_N$  (tension loading) or  $\alpha_V$  (shear loading) from the tables below. For further consult EOTA TR053 and the respective ETA for HIT-HY 270.

**Reduction factor  $\beta$  for static and quasi-static loads**

Use categories			w/w and w/d		d/d	
Temperature range			Ta*	Tb*	Ta*	Tb*
Base material	Steel element	Cleaning				
Solid clay brick (EN 771-1)	HAS-U, HIT-V M8-M16	CAC	0,96	0,96	0,96	0,96
		MC	0,84	0,84	0,84	0,84
Solid calcium silicate brick (EN 771-2)		CAC/MC	-	-	0,96	0,80
Solid light weight concrete brick (EN 771-3)		CAC	0,82	0,68	0,96	0,80
		MC	0,81	0,67	0,90	0,75
Solid normal weight concrete brick (EN 771-3)		CAC/MC	0,96	0,80	0,96	0,80
Hollow clay brick (EN 771-1)		CAC	0,96	0,96	0,96	0,96
		MC	0,84	0,84	0,84	0,84
Hollow calcium silicate brick (EN 771-2)		CAC/MC	-	-	0,96	0,80
Hollow light weight concrete brick (EN 771-3)		CAC	0,69	0,57	0,81	0,67
		MC	0,68	0,56	0,76	0,63
Hollow normal weight concrete brick (EN 771-3)		CAC/MC	0,96	0,80	0,96	0,80
Rosso Classico, Rosso Vivo (EN 771-1)	HAS-U, HIT-V M12, Rebar $\varnothing 8$ , $\varnothing 12$	CAC	0,91	0,91	0,96	0,96

\*Ta / Tb, w/w and d/d anchorage parameters, as defined on Table page 9

**Reduction factors  $\alpha_{N,seis}$ ,  $\alpha_{V,seis}$  for seismic loads**

Use categories			w/w and w/d		d/d		
Temperature range			Ta*	Tb*	Ta*	Tb*	
Base material	Steel element	$h_{ef}$	Cleaning				
Solid clay brick (EN 771-1) Rosso Classico A6R55 or Rosso Vivo A6R55W	<b>Tension loads (<math>\alpha_{N,seis}</math>)</b>						
	Rebar $\varnothing 8$	$\geq 100$	CAC	0,65	0,65	0,65	0,65
		$\geq 200$	CAC	0,53	0,53	0,55	0,55
	Rebar $\varnothing 12$ ; HIT-V, HAS-U M12	$\geq 50$	CAC	0,56	0,56	0,56	0,56
		$\geq 300$	CAC	0,53	0,53	0,56	0,56
	<b>Shear loads (<math>\alpha_{V,seis}</math>)</b>						
	Rebar $\varnothing 8$	$\geq 100$	CAC	0,36	0,36	0,36	0,36
		Rebar $\varnothing 12$ ; HIT-V, HAS-U M12	$\geq 100$	CAC	0,20	0,20	0,20

## Materials

### Material quality

Part	Material
Threaded rod HIT-V 5.8 (F) HAS-U 5.8 (HDG)	Strength class 5.8, A5 > 8% ductile Electroplated zinc coated $\geq 5 \mu\text{m}$ ; (F), (HDG) Hot dip galvanized $\geq 45 \mu\text{m}$
Threaded rod HIT-V 8.8 (F) HAS-U 8.8 (HDG)	Strength class 8.8, A5 > 8% ductile Electroplated zinc coated $\geq 5 \mu\text{m}$ ; (F), (HDG) Hot dip galvanized $\geq 45 \mu\text{m}$
Threaded rod HIT-V-R HAS-U A4	Stainless steel grade A4 A5 > 8% ductile strength class 70, 1.4401; 1.4404; 1.4578; 1.4571; 1.4439; 1.4362
Threaded rod HIT-V-HCR HAS-U HCR	High corrosion resistant steel, A5 > 8% ductile 1.4529, 1.4565
Washer	Electroplated zinc coated, hot dip galvanized
	Stainless steel 1.4401; 1.4404; 1.4578; 1.4571; 1.4439; 1.4362
	High corrosion resistant steel 1.4529, 1.4565 EN 10088
Nut	Strength class 8 steel galvanized $\geq 5 \mu\text{m}$ , ; hot dipped galvanized $\geq 45 \mu\text{m}$
	Strength class 70, stainless steel grade A4, 1.4401; 1.4404; 1.4578; 1.4571; 1.4439; 1.4362
	Strength class 70, high corrosion resistant steel, 1.4529; 1.4565
Internally threaded sleeve HIT-IC	A5 > 8% ductile ; Electroplated zinc coated $\geq 5 \mu\text{m}$
Sieve sleeve HIT-SC	Frame: Polyfort FPP 20T ; Sieve: PA6.6 N500/200

### Base materials:

- Solid brick masonry. The resistances are also valid for larger brick sizes and larger compressive strengths of the masonry unit (in case of static and seismic loading)
- Hollow brick masonry (only in case of static loading)
- Mortar strength class of the masonry: M2,5 at minimum according to EN 998-2: 2010.
- For other bricks in solid masonry and in hollow or perforated masonry, the characteristic resistance of the anchor may be determined by on-site tests according to EOTA TR053 under consideration of the  $\beta$ -factor (for static loading) or  $\alpha$ -factor (for seismic loading) according to the table on page 21.

## Installation parameters

### Applications for hollow and solid bricks with sieve sleeves

For installing HIT-V, HAS-U and HIT-IC with embedments of 50 and 80 mm, a single sieve sleeve is used.

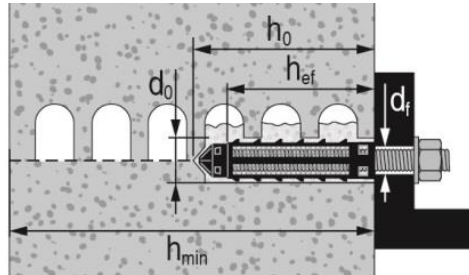

Hollow brick with threaded rod HIT-V, HAS-U or internally threaded sleeve HIT-IC and a single sieve sleeve HIT-SC

### Installation parameters of HIT-V / HAS-U with one sieve sleeve HIT-SC in hollow and solid brick

HIT-V / HAS-U		M6		M8		M10		M12		M16	
with HIT-SC		12x85	16x50	16x85	16x50	16x85	18x50	18x85	22x50	22x85	
Nominal diameter of drill bit	$d_0$ [mm]	12	16	16	16	16	18	18	22	22	
Drill hole depth	$h_0$ [mm]	95	60	95	60	95	60	95	60	95	
Effective embedment depth	$h_{ef}$ [mm]	80	50	80	50	80	50	80	50	80	
Maximum diameter of clearance hole in the fixture	$d_f$ [mm]	7	9	9	12	12	14	14	18	18	
Minimum wall thickness	$h_{min}$ [mm]	115	80	115	80	115	80	115	80	115	
Brush HIT-RB	- [-]	12	16	16	16	16	18	18	22	22	
Number of strokes HDM	- [-]	5	4	6	4	6	4	8	6	10	
Nr. of strokes HDE 500-A	- [-]	4	3	5	3	5	3	6	5	8	
Max. torque moment for all brick types except "parpaing creux"	$T_{max}$ [Nm]	0	3	3	4	4	6	6	8	8	
Maximum torque moment for "parpaing creux"	$T_{max}$ [Nm]	-	2	2	2	2	3	3	6	6	

### Installation parameters of HIT-IC with HIT-SC in hollow and solid brick

HIT-IC		M8		M10		M12	
with HIT-SC		16x85		18x85		22x85	
Nominal diameter of drill bit	$d_0$ [mm]	16		18		22	
Drill hole depth	$h_0$ [mm]	95		95		95	
Effective embedment depth	$h_{ef}$ [mm]	80		80		80	
Thread engagement length	$h_s$ [mm]	8...75		10...75		12...75	
Maximum diameter of clearance hole in the fixture	$d_f$ [mm]	9		12		14	
Minimum wall thickness	$h_{min}$ [mm]	115		115		115	
Brush HIT-RB	- [-]	16		18		22	
Number of strokes HDM	- [-]	6		8		10	
Number of strokes HDE-500	- [-]	5		6		8	
Maximum torque moment	$T_{max}$ [Nm]	3		4		6	

### Applications for hollow and solid bricks with sieve sleeves (cont.)

For installing HIT-V, HAS-U and HIT-IC with embedments of 130 and 160 mm, two attached sleeves HIT-SC are used.

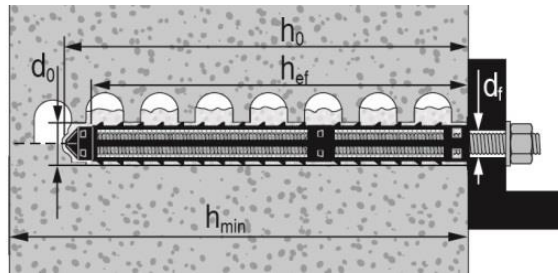

Hollow brick with threaded rod HIT-V / HAS-U and two sieve sleeves HIT-SC for deeper embedment depth

### Installation parameters of HIT-V / HAS-U with two attached sleeves HIT-SC in hollow and solid brick

HIT-V / HAS-U		M8		M10		M12		M16	
<b>with HIT-SC</b>		16x50 +	16x85 +	16x50 +	16x85 +	18x50 +	18x85 +	22x50 +	22x85 +
Nominal diameter of drill bit	$d_0$ [mm]	16	16	16	16	18	18	22	22
Drill hole depth	$h_0$ [mm]	145	180	145	180	145	180	145	180
Effective embedment depth	$h_{ef}$ [mm]	130	160	130	160	130	160	130	160
Maximum diameter of clearance hole in the fixture	$d_f$ [mm]	9	9	12	12	14	14	18	18
Minimum wall thickness	$h_{min}$ [mm]	195	230	195	230	195	230	195	230
Brush HIT-RB	- [-]	16	16	16	16	18	18	22	22
Number of strokes HDM	- [-]	4+6	6+6	4+6	6+6	4+8	8+8	6+10	10+10
Number of strokes HDE-500	- [-]	3+5	5+5	3+5	5+5	3+6	6+6	5+8	8+8
Maximum torque moment	$T_{max}$ [Nm]	3	3	4	4	6	6	8	8



### Applications for hollow and solid bricks with sieve sleeves (cont.)

For through fastenings with HIT-V and HAS-U, two attached sleeves HIT-SC are used.

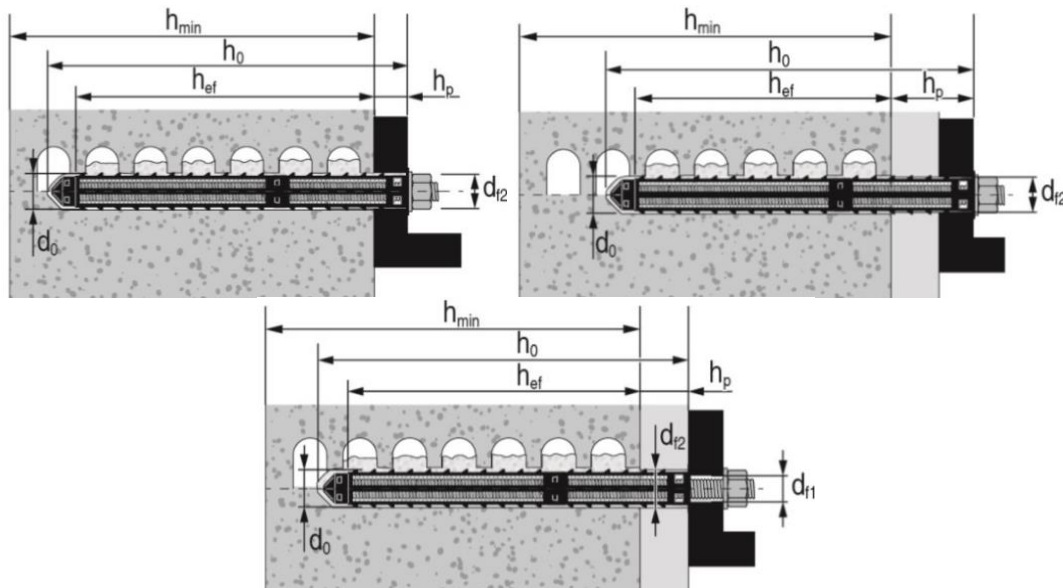

Hollow and solid brick with threaded rod HIT-V and HAS-U with two sieve sleeves HIT-SC for setting through the fixture and/or through the non-loadbearing layer

### Installation parameters of HIT-V / HAS-U with two sieve sleeves through the fixture and/or through the non-loadbearing layer in hollow and solid bricks

HIT-V / HAS-U		M8		M10		M12		M16	
<b>with HIT-SC</b>		16x50 + 16x85	16x85 + 16x85	16x50 + 16x85	16x85 + 16x85	18x50 + 18x85	18x85 + 18x85	22x50 + 22x85	22x85 + 22x85
Nominal diameter of drill bit	$d_0$ [mm]	16	16	16	16	18	18	22	22
Drill hole depth	$h_0$ [mm]	145	180	145	180	145	180	145	180
Effective embedment depth	$h_{ef, min}$ [mm]	80	80	80	80	80	80	80	80
Max. thickness of non-loadbearing layer and fixture (through setting)	$h_{p, max}$ [mm]	50	80	50	80	50	80	50	80
Max. diameter of clearance hole in the fixture (pre-setting)	$d_{r1}$ [mm]	9	9	12	12	14	14	18	18
Max. diameter of clearance hole in fixture (through setting)	$d_{r2}$ [mm]	17	17	17	17	19	19	23	23
Minimum wall thickness	$h_{min}$ [mm]	$h_{ef}+65$	$h_{ef}+70$	$h_{ef}+65$	$h_{ef}+70$	$h_{ef}+65$	$h_{ef}+70$	$h_{ef}+65$	$h_{ef}+70$
Brush HIT-RB	- [-]	16	16	16	16	18	18	22	22
Number of strokes HDM	- [-]	4+6	6+6	4+6	6+6	4+8	8+8	6+10	10+10
Number of strokes HDE	- [-]	3+5	5+5	3+5	5+5	5+8	8+8	5+8	8+8
Max. torque moment for all brick types except "parpaing creux"	$T_{max}$ [Nm]	3	3	4	4	6	6	8	8
Max. torque moment for "parpaing creux"	$T_{max}$ [Nm]	2	2	2	2	3	3	6	6

### Applications for solid bricks without sieve sleeves.

Hilti recommends the anchoring in masonry always with sieve sleeve. Anchors can only be installed without sieve sleeves in solid bricks when it is guaranteed that it has not any hole or void.

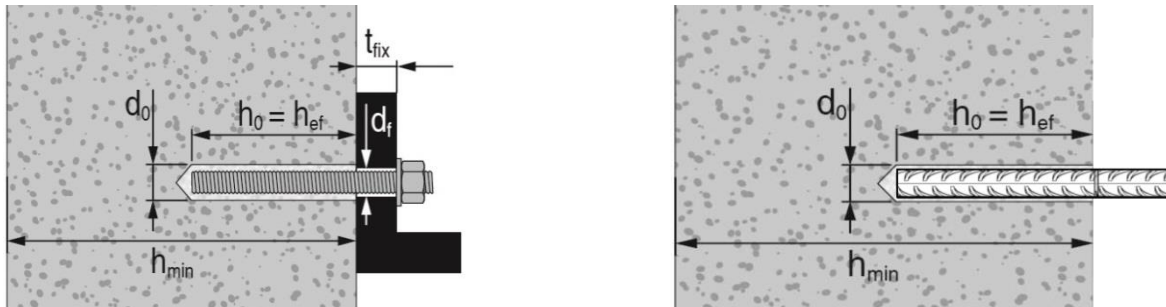

Solid brick with threaded rod HIT-V or HAS-U or Rebar

### Installation parameters of HIT-V / HAS-U / Rebar in solid bricks

Type of element	HAS-U, HIT-V				Rebar	
Anchor size	M8	M10	M12	M16	Ø8	Ø12
Nominal diameter of drill bit $d_0$ [mm]	10	12	14	18	12	14
Drill hole depth = Effective embedment depth $h_0 = h_{ef}$ [mm]	50...300	50...300	50...350 <sup>a)</sup>	50...300	100...200	50...350 <sup>a)</sup>
Maximum diameter of clearance hole in the fixture $d_f$ [mm]	9	12	14	18	9	14
Minimum wall thickness $h_{min}$ [mm]	$h_0+30$	$h_0+30$	$h_0+30$	$h_0+36$	$h_0+30; \geq 250$	
Brush HIT-RB	-	-	14	18	12	14
Maximum torque moment $T_{max}$ [Nm]	5	8	$h_{ef} < 100 \text{ mm} : 5$ $h_{ef} \geq 100 \text{ mm} : 10$	10	-	-

a) Additional details – see in ETA-22/0395

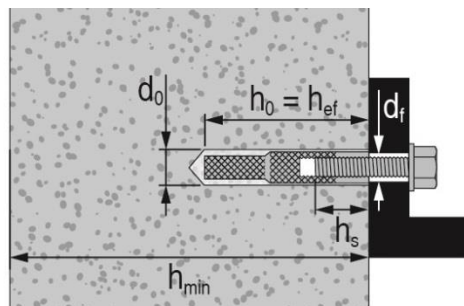

Solid brick with internal threaded sleeve HIT-IC

### Installation parameters of HIT-IC in solid bricks

HIT-IC		M8x80	M10x80	M12x80
Nominal diameter of drill bit $d_0$ [mm]		14	16	18
Drill hole depth = Effective embedment depth $h_0 = h_{ef}$ [mm]		80	80	80
Thread engagement length $h_s$ [mm]		8...75	10...75	12...75
Maximum diameter of clearance hole in the fixture $d_f$ [mm]		9	12	14
Minimum wall thickness $h_{min}$ [mm]		115	115	115
Brush HIT-RB	-	14	16	18
Maximum torque moment $T_{max}$ [Nm]		5	8	10

**Working time and curing time for solid bricks**

Temperature in the base material	Maximum working time	Minimum curing time
$T_{BM}$	$t_{work}$	$t_{cure}^{1)}$
5 °C to 9 °C	10 min	2,5 h
10 °C to 19 °C	7 min	1,5 h
20 °C to 29 °C	4 min	30 min
30 °C to 40 °C	1 min	20 min

1) The curing time data are valid for dry base material only. In wet base material, the curing times must be doubled.

**Working time and curing time for hollow bricks**

Temperature in the base material	Maximum working time	Minimum curing time
$T_{BM}$	$t_{work}$	$t_{cure}^{1)}$
-5 °C to -1 °C <sup>2)</sup>	10 min	6 h
0 °C to 4 °C	10 min	4 h
5 °C to 9 °C	10 min	2,5 h
10 °C to 19 °C	7 min	1,5 h
20 °C to 29 °C	4 min	30 min
30 °C to 40 °C	1 min	20 min

1) The curing time data are valid for dry base material only. In wet base material, the curing times must be doubled;

2) Only for HIT-V anchor rods acc.to ETA-13/1036

**Installation equipment**

Type of steel element	HAS-U, HIT-V					Rebar	
Anchor size	M6	M8	M10	M12	M16	Ø8	Ø12
Rotary hammer	TE2(A) – TE30(A)						
Other tools	compressed air gun or blow out pump, set of cleaning brushes, dispenser						

**Drilling and cleaning parameters**

HIT-V / HAS-U <sup>a)</sup>	HIT-V / HAS-U + sieve sleeve	HIT-IC <sup>a)</sup>	HIT-IC + sieve sleeve	Rebar	Hammer drill	Brush HIT-RB
					$d_0$ [mm]	size [mm]
M6	-	-	-	-	8	8
M8	-	-	-	Ø8	10	10
M10	-	-	-	-	12	12
M12	-	M8	-	Ø12	14	14
-	M8	M10	M8	-	16	16
-	M10	-	-	-	16	16
M16	M12	M12	M10	-	18	18
-	M16	-	M12	-	22	22

a) Installation without the sieve sleeve HIT-SC can be used only in case of solid bricks.

## Setting instructions

**\*For detailed information on installation see instruction for use given with the package of the product.**



### Safety regulations.

Review the Material Safety Data Sheet (MSDS) before use for proper and safe handling! Wear well-fitting protective goggles and protective gloves when working with Hilti HIT-HY 270.

### Drilling

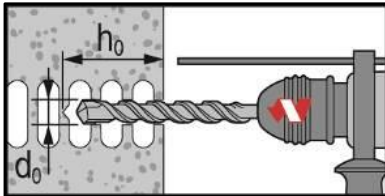

**In hollow bricks: rotary mode**

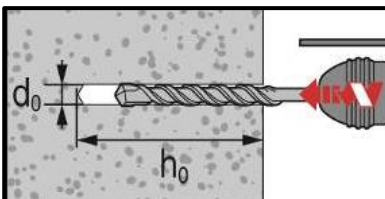

**In solid bricks: hammer mode**

### Cleaning

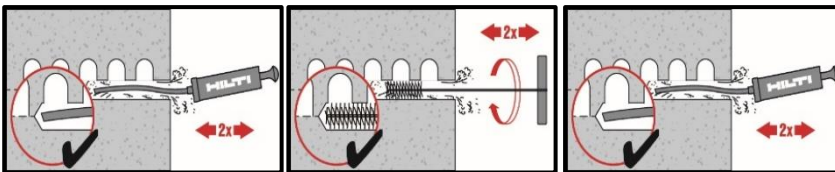

#### Manual cleaning (MC)

For drill hole diameter  $d_0 \leq 18$  mm and drill hole depth  $h_0 \leq 100$  mm

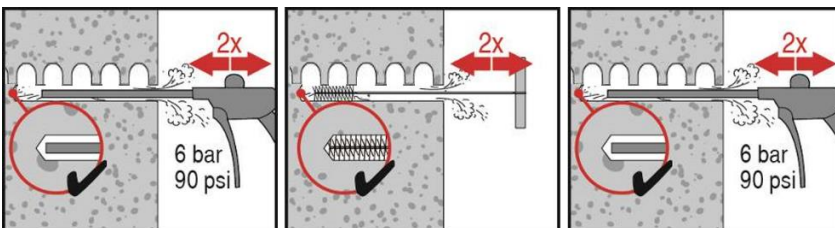

#### Compressed air cleaning (CAC)

For drill hole depth  $h_0 \leq 300$  mm

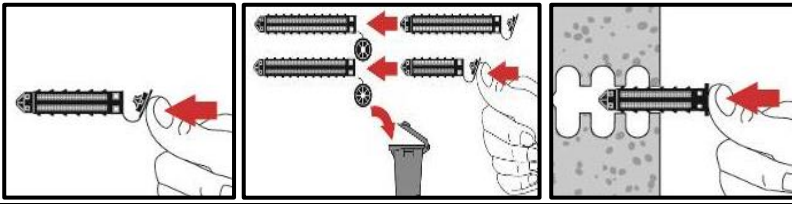
**Injection preparation for hollow and solid bricks with sieve sleeve**

Close lid and insert sieve sleeve manually.

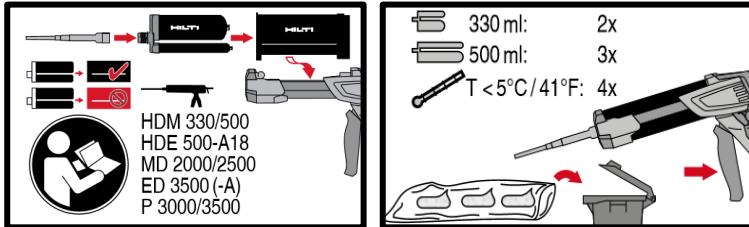
**All applications**

Injection system preparation.

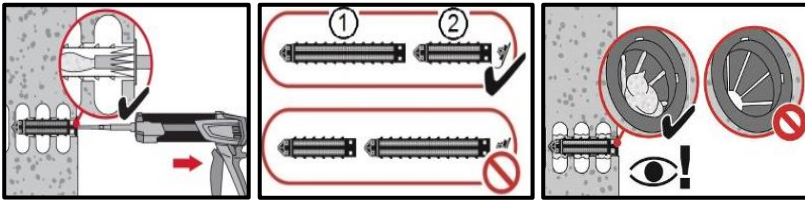
**Inject the adhesive without forming air voids**

**Injection method 1** for Installation with sieve sleeve HIT-SC. Use extension for installation with two sieve sleeves.

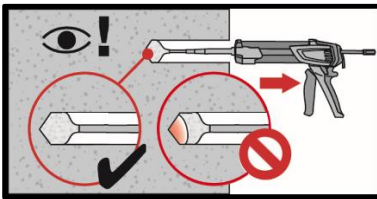

**Injection method 2** for installation in solid bricks without sieve sleeve

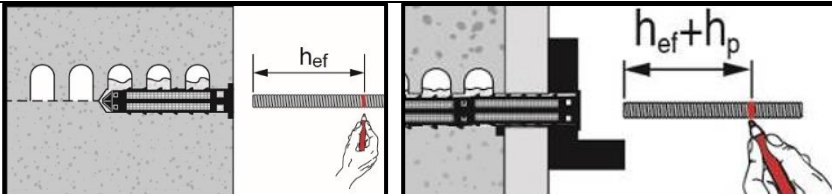
**Setting the element**

**Marking and setting element**, to the required embedment depth, observing working time  $t_{work}$ .

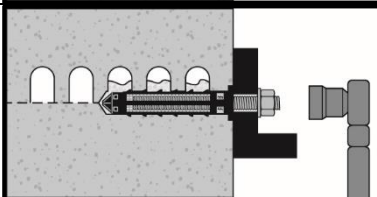

**Loading the anchor:** After required curing time  $t_{cure}$  the anchor can be loaded. The applied installation torque shall not exceed the values  $T_{max}$ .

## 3. MECHANICAL ANCHORS

### 3.1 Expansion anchors

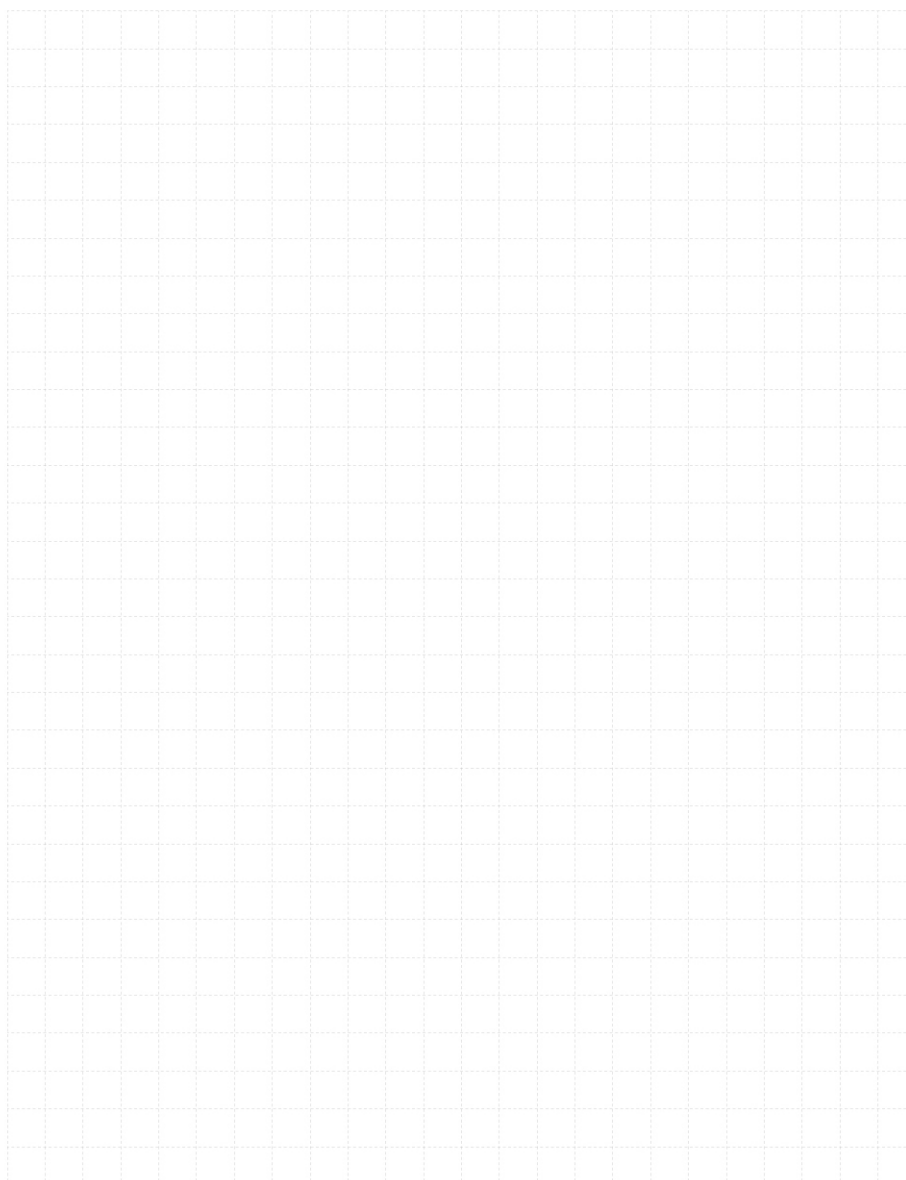

#### 3.1.1 HST3













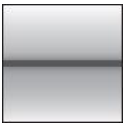

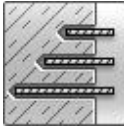
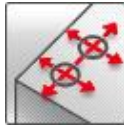
# HST3 Expansion anchor

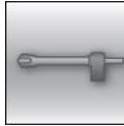
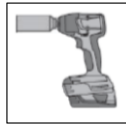
## Ultimate-performance expansion anchor for cracked concrete and seismic

Anchor version	Benefits
 <p>HST3 HST3-R (M8-M24)</p>	<ul style="list-style-type: none"> <li>- Ultimate resistance for reduced member thickness, short spacing and edge distances</li> <li>- Suitable for non-cracked and cracked concrete C 12/15 to C 80/95*</li> <li>- Highly reliable and safe anchor for structural seismic design with ETA C1/C2 assessment</li> <li>- Longer embedment depth option to get higher resistance, closer distance to the edge or smaller spacing.</li> <li>- Full design flexibility with variable embedment depth and edge &amp; spacing</li> <li>- Faster and reliable installation thanks to approved non-cleaning and adaptive torqueing tool.</li> <li>- Dome-nut version is available with adaptive tool qualification</li> <li>- Product and length identification mark facilitates quality control and inspection</li> </ul>
 <p>HST3 DN HST3-R DN (M8-M16)</p>	
 <p>HST3 BW HST3-R BW (M8-M24)</p>	

Base material	Load conditions
 <p>Concrete (non-cracked)</p>	 <p>Concrete (cracked)</p>
 <p>Static/ quasi-static</p>	 <p>Seismic ETA-C1/C2</p>
 <p>Fire resistance</p>	 <p>Variable embedment depth</p>
 <p>Small edge distance and spacing</p>	
Installation conditions	Other information
 <p>Hammer drilled holes (with no cleaning)</p>	 <p>Diamond drilled holes</p>
 <p>Hollow drill- bit drilling</p>	 <p>Impact wrench with adaptative torque module (M8-M16)</p>
 <p>European Technical Assessment</p>	 <p>CE conformity</p>
 <p>PROFIS Engineering design software</p>	 <p>Corrosion resistance</p>

### Approvals / certificates

Description	Authority / Laboratory	No. / date of issue
European technical assessment <sup>a)</sup>	DIBt, Berlin	ETA-98/0001 / 2022-11-03
Fire test report	DIBt, Berlin	ETA-98/0001 / 2022-11-03
Evaluation report acc. to ICC-ES criteria	Uniform Evaluation Service	578 / 2019-02-28
Certificate of compliance	FM	003053697 / 2016-01-25
Shock approval M10 - M24	BABS, Spiez Laboratory	BZS D 08-602 / 2019-01-29

a) All data given in this section according to ETA-98/0001, issue 2022-11-03.

\* ETA ETA-98/0001 covers the concrete strength class between C20/25 and C 50/60. Strength classes out of this interval are covered by Hilti Technical Data

**Static and quasi-static loading (for a single anchor)**
**All data in this section applies to:**

- Correct setting (See setting instruction)
- No edge distance and spacing influence
- Steel failure
- Minimum base material thickness
- Concrete C 20/25,  $f_{ck,cyl} = 20 \text{ N/mm}^2$  (EN 1992-4 design)

**Effective anchorage depth for static**

Anchor size		M8	M10		M12		M16		M20	M24
Approved variable embedment depth range <sup>a)</sup>	$h_{ef,min} - h_{ef,max}$ [mm]	47-90	40-100		50-125		65-160		101-180	125
Effective anchorage depth <sup>b)</sup>	$h_{ef}$ [mm]	47	40	60	50	70	65	85	101	125

a) Variable embedment depth approved by ETA-98/0001 of 2021-05-04;

b) Standard embedment depth used for calculations of values below. For other embedment depths PROFIS Engineering can be used

**Characteristic resistance**

Anchor size		M8	M10		M12		M16		M20	M24	
<b>Non-cracked concrete</b>											
Tension	HST3 (-BW, -DN)	$N_{Rk}$ [kN]	12,0	12,4	22,0	17,4	25,0	25,8	38,6	49,9	60,0
	HST3-R (-BW, -DN)		12,0	12,4	22,0	17,4	25,0	25,8	38,6	49,9	60,0
Shear	HST3 (-BW, -DN)	$V_{Rk}$ [kN]	13,8	21,9	23,6	34,0	35,4	54,5	55,3	83,9	94,0
	HST3-R (-BW, -DN)		15,7	25,6	25,3	31,1	36,7	48,6	63,6	97,2	115,0
<b>Cracked concrete</b>											
Tension	HST3 (-BW, -DN)	$N_{Rk}$ [kN]	8,0	8,7	15,0	12,2	20,0	18,0	27,0	35,0	40,0
	HST3-R (-BW, -DN)		8,5	8,7	15,0	12,2	20,0	18,0	27,0	35,0	40,0
Shear	HST3 (-BW, -DN)	$V_{Rk}$ [kN]	13,8	21,9	23,6	33,8	35,4	54,5	55,3	83,9	94,0
	HST3-R (-BW, -DN)		15,7	23,3	25,3	31,1	36,7	48,6	63,6	97,2	115,0

**Design resistance**

Anchor size		M8	M10		M12		M16		M20	M24	
<b>Non-cracked concrete</b>											
Tension	HST3 (-BW, -DN)	$N_{Rd}$ [kN]	8,0	8,3	14,7	11,6	16,7	17,2	25,7	33,3	40,0
	HST3-R (-BW, -DN)		8,0	8,3	14,7	11,6	16,7	17,2	25,7	33,3	40,0
Shear	HST3 (-BW, -DN)	$V_{Rd}$ [kN]	11,0	17,5	18,9	27,2	28,3	43,6	44,2	67,1	62,7
	HST3-R (-BW, -DN)		12,6	20,5	20,2	24,9	29,4	38,9	50,9	77,8	88,5
<b>Cracked concrete</b>											
Tension	HST3 (-BW, -DN)	$N_{Rd}$ [kN]	5,3	5,8	10,0	8,1	13,3	12,0	18,0	23,3	26,7
	HST3-R (-BW, -DN)		5,7	5,8	10,0	8,1	13,3	12,0	18,0	23,3	26,7
Shear	HST3 (-BW, -DN)	$V_{Rd}$ [kN]	11,0	15,5	18,9	22,6	28,3	41,0	44,2	67,1	62,7
	HST3-R (-BW, -DN)		12,6	15,5	20,2	22,6	29,4	38,9	50,9	74,6	80,2



**Recommended loads<sup>a)</sup>**

Anchor size		M8	M10	M12	M16	M20	M24				
<b>Non-cracked concrete</b>											
Tension	HST3 (-BW, -DN)	N <sub>Rec</sub> [kN]	5,7	5,9	10,5	8,3	11,9	12,3	18,4	23,8	28,6
	HST3-R (-BW, -DN)		5,7	5,9	10,5	8,3	11,9	12,3	18,4	23,8	28,6
Shear	HST3 (-BW, -DN)	V <sub>Rec</sub> [kN]	7,9	12,5	13,5	19,4	20,2	31,1	31,6	47,9	44,8
	HST3-R (-BW, -DN)		9,0	14,6	14,5	17,8	21,0	27,8	36,3	55,5	63,2
<b>Cracked concrete</b>											
Tension	HST3 (-BW, -DN)	N <sub>Rec</sub> [kN]	3,8	4,1	7,1	5,8	9,5	8,6	12,9	16,6	19,0
	HST3-R (-BW, -DN)		4,0	4,1	7,1	5,8	9,5	8,6	12,9	16,6	19,0
Shear	HST3 (-BW, -DN)	V <sub>Rec</sub> [kN]	7,9	11,1	13,5	16,1	20,2	29,3	31,6	47,9	44,8
	HST3-R (-BW, -DN)		9,0	11,1	14,5	16,1	21,0	27,8	36,3	53,3	57,3

a) With overall partial safety factor for action  $\gamma = 1,4$ . The partial safety factors for action depend on the type of loading and shall be taken from national regulations

**Seismic loading (for a single anchor)**
**All data in this section applies to:**

- Correct setting (See setting instruction)
- No edge distance and spacing influence
- Steel failure
- Minimum base material thickness
- Concrete C 20/25,  $f_{ck,cyl} = 20 \text{ N/mm}^2$  (EN 1992-4 design)
- $\alpha_{gap} = 1,0$  (using Hilti seismic filling set)

**Effective anchorage depth for seismic C2 and C1**

Anchor size		M8	M10	M12	M16	M20	M24
Approved variable embedment depth range <sup>a)</sup>	$h_{ef,min} - h_{ef,max}$ [mm]	47-90	60-100	70-125	85-160	101-180	-
Effective anchorage depth <sup>b)</sup>	$h_{ef}$ [mm]	47	60	70	85	101	-

a) Variable embedment depth approved by ETA-98/0001 of 2021-05-04;

b) Standard embedment depth used for calculations of values below. For other embedment depths PROFIS Engineering can be used

**Characteristic resistance in case of seismic performance C2 (with Hilti filling set)**

Anchor size		M8	M10	M12	M16	M20	M24	
Tension	HST3 (-BW, -DN)	N <sub>Rk, seis</sub> [kN]	3,0	10,4	17,1	22,9	29,7	-
	HST3-R (-BW, -DN)		3,4	10,4	17,1	22,9	29,7	-
Shear	HST3 (-BW, -DN)	V <sub>Rk, seis</sub> [kN]	9,9	19,0	28,6	48,5	84,3	-
	HST3-R (-BW, -DN)		9,9	17,2	27,6	42,5	67,4	-

**Design resistance in case of seismic performance C2 (with Hilti filling set)**

Anchor size		M8	M10	M12	M16	M20	M24	
Tension	HST3 (-BW, -DN)	N <sub>Rk, seis</sub> [kN]	2,0	6,9	11,4	15,3	19,8	-
	HST3-R (-BW, -DN)		2,3	6,9	11,4	15,3	19,8	-
Shear	HST3 (-BW, -DN)	V <sub>Rk, seis</sub> [kN]	7,9	15,2	22,9	38,8	63,4	-
	HST3-R (-BW, -DN)		7,9	13,8	22,1	34,0	53,9	-

**Characteristic resistance in case of seismic performance C1 (with Hilti filling set)**

Anchor size			M8	M10	M12	M16	M20	M24
Tension	HST3 (-BW, -DN)	$N_{Rk, se}$ [kN]	8,0	13,6	17,1	22,9	29,7	-
	HST3-R (-BW, -DN)		8,5	13,6	17,1	22,9	29,7	-
Shear	HST3 (-BW, -DN)	$V_{Rk, se}$ [kN]	16,6	25,8	39,0	60,9	95,1	-
	HST3-R (-BW, -DN)		19,5	28,4	44,3	70,2	95,1	-

**Design resistance in case of seismic performance C1**

Anchor size			M8	M10	M12	M16	M20	M24
Tension	HST3 (-BW, -DN)	$N_{Rd, se}$ [kN]	5,3	9,1	11,4	15,3	19,8	-
	HST3-R (-BW, -DN)		5,7	9,1	11,4	15,3	19,8	-
Shear	HST3 (-BW, -DN)	$V_{Rd, se}$ [kN]	13,3	20,6	31,2	48,7	63,4	-
	HST3-R (-BW, -DN)		15,6	22,7	31,8	52,1	63,4	-

**Fire resistance**
**All data in this section applies to:**

- Correct setting (See setting instruction)
- No edge distance and spacing influence
- Steel failure
- Minimum base material thickness
- Concrete C 20/25,  $f_{ck, cyl} = 20 \text{ N/mm}^2$  (EN 1992-4 design)
- Hilti technical data for concrete strength class C55/67 to C80/95: for a structural element that fulfills the requirements according to DIN EN 1992-1-2 the fire resistance of C20/25 could be assumed.
- partial safety factor for resistance under fire exposure  $\gamma_{M, fi} = 1,0$  (in absence of other national regulations)

**Effective anchorage depth for static**

Anchor size			M8	M10	M12	M16	M20	M24			
Approved variable embedment depth range <sup>a)</sup>	$h_{ef, min}$	[mm]	47-	40-	60-	50-	70-	65-	85-	101-	125
	$h_{ef, max}$		90	59	100	69	125	84	160	180	
Effective anchorage depth <sup>b)</sup>		$h_{ef}$	47	40	60	50	70	65	85	101	125

a) Variable embedment depth approved by ETA-98/0001 of 2021-05-04;

b) Standard embedment depth used for calculations of values below. For other embedment depths PROFIS Engineering can be used

**Characteristic resistance**

Anchor size			M8	M10	M12	M16	M20	M24			
<b>Fire Exposure R30</b>											
Tension	HST3 (-BW, -DN)	$N_{Rk, fi}$ [kN]	0,9	1,5	2,4	2,3	5,0	4,4	7,1	9,1	12,6
	HST3-R (-BW, -DN)		1,9	1,8	3,0	3,2	5,0	4,7	7,1	9,1	12,6
Shear	HST3 (-BW, -DN)	$V_{Rk, fi}$ [kN]	0,9	1,5	2,4	2,3	5,2	4,4	9,7	15,2	21,9
	HST3-R (-BW, -DN)		4,9	4,7	11,8	8,9	17,1	16,9	31,9	37,0	62,8
<b>Fire Exposure R120</b>											
Tension	HST3 (-BW, -DN)	$N_{Rk, fi}$ [kN]	0,6	0,8	0,9	0,8	1,3	1,5	2,4	3,8	5,4
	HST3-R (-BW, -DN)		1,5	1,5	2,4	2,5	4,0	3,8	5,6	7,3	10,1
Shear	HST3 (-BW, -DN)	$V_{Rk, fi}$ [kN]	0,6	0,8	0,9	0,8	1,3	1,5	2,4	3,8	5,4
	HST3-R (-BW, -DN)		1,7	2,0	3,3	3,3	4,8	6,2	9,0	14,1	20,3

**Design resistance**

Anchor size				M8	M10	M12	M16	M20	M24			
<b>Fire Exposure R30</b>												
Tension	HST3 (-BW, -DN)	$N_{Rd,fi}$	[kN]	0,9	1,5	2,4	2,3	5,0	4,4	7,1	9,1	12,6
	HST3-R (-BW, -DN)			1,9	1,8	3,0	3,2	5,0	4,7	7,1	9,1	12,6
Shear	HST3 (-BW, -DN)	$V_{Rd,fi}$	[kN]	0,9	1,5	2,4	2,3	5,2	4,4	9,7	15,2	21,9
	HST3-R (-BW, -DN)			4,9	4,7	11,8	8,9	17,1	16,9	31,9	37,0	62,8
<b>Fire Exposure R120</b>												
Tension	HST3 (-BW, -DN)	$N_{Rd,fi}$	[kN]	0,6	0,8	0,9	0,8	1,3	1,5	2,4	3,8	5,4
	HST3-R (-BW, -DN)			1,5	1,5	2,4	2,5	4,0	3,8	5,6	7,3	10,1
Shear	HST3 (-BW, -DN)	$V_{Rd,fi}$	[kN]	0,6	0,8	0,9	0,8	1,3	1,5	2,4	3,8	5,4
	HST3-R (-BW, -DN)			1,7	2,0	3,3	3,3	4,8	6,2	9,0	14,1	20,3

For more information about different failure modes and fire resistance times please see the full ETA-98/0001 report

**Materials**
**Mechanical properties**

Anchor size				M8	M10	M12	M16	M20	M24	
Nominal tensile strength	HST3 (-BW, -DN)	$f_{uk,thread}$	[N/mm <sup>2</sup> ]	800	800	800	720	700	530	
	HST3-R (-BW, -DN)			720	710	710	650	650	650	
Yield strength	HST3 (-BW, -DN)	$f_{yk,thread}$	[N/mm <sup>2</sup> ]	640	640	640	576	560	450	
	HST3-R (-BW, -DN)			576	568	568	520	520	500	
Stressed cross-section			$A_s$	[mm <sup>2</sup> ]	36,6	58,0	84,3	157	245	353
Moment of resistance			$W$	[mm <sup>3</sup> ]	31,2	62,3	109	277	541	935
Characteristic bending resistance	HST3 (-BW, -DN)	$M^0_{Rk,s}$	[Nm]	30	60	105	240	457	595	
	HST3-R (-BW, -DN)			27	53	93	216	425	730	

**Material quality**

Part		Material
Expansion sleeve	HST3 (-BW, -DN)	M10, M16: Galvanized or Stainless steel M8, M12, M20, M24: Stainless steel
	HST3-R (-BW, -DN)	Stainless steel A4
Bolt	HST3 (-BW, -DN)	Carbon steel, galvanized, coated (transparent)
	HST3-R (-BW, -DN)	Stainless steel A4, cone coated (transparent)
Washer	HST3 (-BW, -DN)	Galvanized
	HST3-R (-BW, -DN)	Stainless steel A4
Hexagon nut	HST3 (-BW)	Strength class 8
	HST3-R (-BW)	Stainless steel A4, coated
Dome nut	HST3 DN	Galvanized
	HST3-R DN	Stainless steel A4, coated

**Anchor dimensions**

Anchor size			M8	M10	M12	M16	M20	M24
Maximum length of anchor	$l_{max} \leq$	[mm]	260	280	350	475	450	500
Shaft diameter at the cone	$d_R$	[mm]	5,60	6,94	8,22	11,00	14,62	17,4
Length of expansion sleeve	$l_s$	[mm]	13,6	16,0	20,0	25,0	28,3	36,0
Diameter of washer	$d_w \geq$	[mm]	15,57	19,48	23,48	29,48	36,38	43,38
Length of dome nut thread	$L_{thread} \geq$	[mm]	13,3	16,8	17,8	22,3	-	-
Length of dome nut	$L_{DN} \geq$	[mm]	18,1	21,9	24,0	29,5	-	-

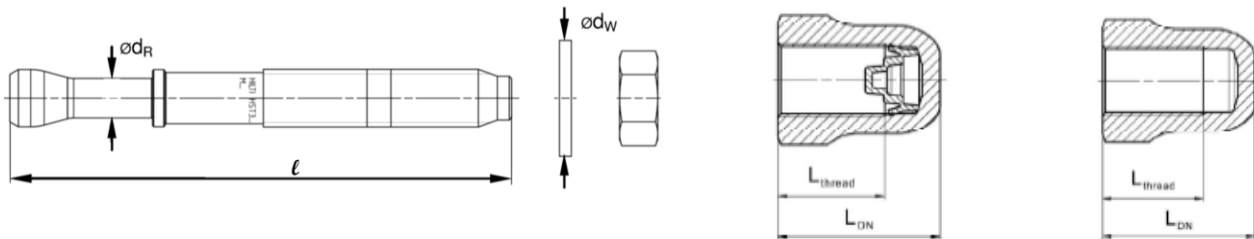
**Setting information**
**Setting details**

Anchor size			M8	M10	M12	M16	M20	M24
Nominal diameter of drill bit	$d_o$	[mm]	8	10	12	16	20	24
Cutting diameter of drill bit	$d_{cut} \leq$	[mm]	8,45	10,45	12,5	16,5	20,55	24,55
Effective embedment depth	$h_{ef,1}$	[mm]	-	40-59	50-69	65-84	-	-
	$h_{ef,2}$	[mm]	47-90	60-100	70-125	85-160	101-180	125
Drill hole depth <sup>1) 3)</sup>	$h_{1,1} \geq$	[mm]	-	$h_{ef}+13$	$h_{ef}+18$	$h_{ef}+21$	-	-
	$h_{1,2} \geq$	[mm]	$h_{ef}+12$	$h_{ef}+13$	$h_{ef}+18$	$h_{ef}+21$	$h_{ef}+23$	151
Nominal embedment depth	$h_{nom,1}$	[mm]	-	$h_{ef}+8$	$h_{ef}+10$	$h_{ef}+13$	-	-
	$h_{nom,2}$	[mm]	$h_{ef}+7$	$h_{ef}+8$	$h_{ef}+10$	$h_{ef}+13$	$h_{ef}+15$	143
Maximum diameter of clearance hole in the fixture <sup>2)</sup>	$d_f$	[mm]	9	12	14	18	22	26
Torque moment	$T_{inst}$	[Nm]	20	45	60	110	180	300
Maximum thickness of fixture	$t_{fix,max}$	[mm]	195	220	270	370	310	330
Width across	SW	[mm]	13	17	19	24	30	36

- 1) In case of diamond drilling +5 mm for M8 to M10 and +2 mm for M12 to M24.
- 2) For the design of bigger clearance holes in the fixture see EN 1992-4:2018.
- 3) In case of hammer drilling with non-cleaned boreholes + 12 mm for M8 to M20.

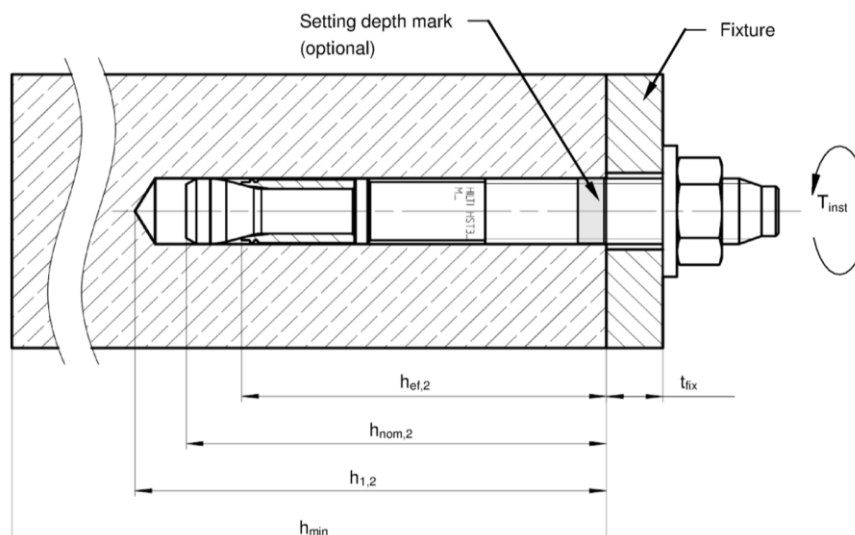

**Installation equipment**

Anchor size	M8	M10	M12	M16	M20	M24
Rotary hammer	TE2(-A) – TE30(-A)				TE40 – TE80	
Diamond coring tool	DD-30W, DD-EC1					
Torquing tool	Hilti SIW 6AT A22 – SI-AT-A22				-	
Setting tool	HS-SC				-	
Hollow drill bit	-		TE-CD, TE-YD			
Other tools	hammer, torque wrench, blow out pump					

**Setting parameters of HST3 (-BW, -DN) / HST3-R (-BW, -DN) for M8 and M10\***

Anchor Size			M8			M10		
Concrete class			C20/25 to C50/60 <sup>a)</sup> C55/67 to C80/95 <sup>b)</sup>	C12/15 <sup>b)</sup> C16/20 <sup>b)</sup>	C20/25 to C50/60 <sup>a)</sup>	C20/25 to C50/60 <sup>a)</sup> C55/67 to C80/95 <sup>b)</sup>	C12/15 <sup>b)</sup> C16/20 <sup>b)</sup>	
Effective anchorage depth	$h_{ef}$	[mm]	47		47	40	60	
Minimum base material thickness	$h_{min}$	[mm]	80	100	100	80	100	120
Minimum spacing in non-cracked concrete	$s_{min}$	[mm]	35	35	35	50	40	40
	for $c \geq$	[mm]	70	55	65	65	90	75
Minimum spacing in cracked concrete	$s_{min}$	[mm]	35	35	35	40	40	40
	for $c \geq$	[mm]	55	40	55	50	70	55
Minimum edge distance in non-cracked concrete	$c_{min}$	[mm]	45	40	50	50	60	50
	for $s \geq$	[mm]	110	80	80	95	130	110
Minimum edge distance in cracked concrete	$c_{min}$	[mm]	40	40	40	45	50	45
	for $s \geq$	[mm]	70	35	75	55	90	65
Critical spacing for splitting failure and concrete cone failure	$s_{cr,sp}$	[mm]	141		188	168	180	
	$s_{cr,N}$	[mm]	141		141	120	180	
Critical edge distance for splitting failure and concrete cone failure	$c_{cr,sp}$	[mm]	71		94	84	90	
	$c_{cr,N}$	[mm]	71		71	60	90	

a) Data covered by ETA-98/0001 issue 2021-05-04.

b) Data covered by Hilti Technical Data

\* ETA-98/0001 provides flexible edge & spacing values for each anchor layout configuration depending on base material thickness. Minimum spacing and edge distance values on the table are recommendations for specific anchor layout and base material dimensions. We kindly ask you to check your designs on PROFIS Engineering software to verify the edge & spacing values.

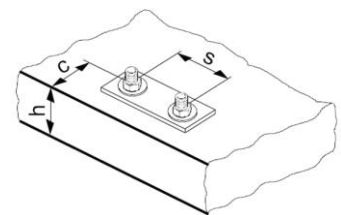

**Setting parameters of HST3 (-BW, -DN) / HST3-R (-BW, -DN) for M12 and M16\***

Anchor Size			M12			M16				
			C20/25 to C50/60 <sup>a)</sup>	C20/25 to C50/60 <sup>a)</sup> C55/67 to C80/95 <sup>b)</sup>	C12/15 <sup>b)</sup> C16/20 <sup>b)</sup>	C20/25 to C50/60 <sup>a)</sup>	C20/25 to C50/60 <sup>a)</sup> C55/67 to C80/95 <sup>b)</sup>	C12/15 <sup>b)</sup> C16/20 <sup>b)</sup>	C12/15 <sup>b)</sup> C16/20 <sup>b)</sup>	
Effective anchorage	$h_{ef}$	[mm]	50	70		70	65	85		85
Minimum base material	$h_{min}$	[mm]	100	120	140	140	120	140	160	160
Minimum spacing in non-cracked concrete	$s_{min}$	[mm]	55	50	60	110	75	80	65	90
	for $c$	[mm]	85	110	85	140	100	115	100	145
Minimum spacing in cracked concrete	$s_{min}$	[mm]	50	50	50	80	65	80	65	70
	for $c \geq$	[mm]	65	80	65	120	75	80	75	125
Minimum edge distance in non-cracked concrete	$c_{min}$	[mm]	60	75	60	90	65	80	70	110
	for $s \geq$	[mm]	130	145	135	190	175	180	160	170
Minimum edge distance in cracked concrete	$c_{min}$	[mm]	55	60	55	80	65	65	65	90
	for $s \geq$	[mm]	75	100	75	170	85	125	85	165
Critical spacing for splitting failure and concrete cone failure	$s_{cr,sp}$	[mm]	180	210		280	208	255		340
	$s_{cr,N}$	[mm]	150	210		210	195	255		255
Critical edge distance for splitting failure and concrete cone failure	$c_{cr,sp}$	[mm]	90	105		140	104	128		170
	$c_{cr,N}$	[mm]	75	105		105	98	128		128

c) Data covered by ETA-98/0001 issue 2021-05-04.

d) Data covered by Hilti Technical Data

\* ETA-98/0001 provides flexible edge & spacing values for each anchor layout configuration depending on base material thickness. Minimum spacing and edge distance values on the table are recommendations for specific anchor layout and base material dimensions. We kindly ask you to check your designs on PROFIS Engineering software to verify the edge & spacing values.

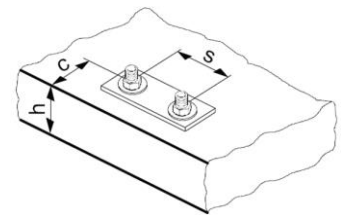

**Setting parameters of HST3(-BW) / HST3-R(-BW) for M20 and M24\***

Anchor Size			M20		M24		
Concrete class			C20/25 to C50/60 <sup>a)</sup> C55/67 to C80/95 <sup>b)</sup>	C12/15 <sup>b)</sup> C16/20 <sup>b)</sup>	C20/25 to C50/60 <sup>a)</sup> C55/67 to C80/95 <sup>b)</sup>	C12/15 <sup>b)</sup> C16/20 <sup>b)</sup>	
Effective anchorage	$h_{ef}$	[mm]	101		101	125	125
Minimum base material	$h_{min}$	[mm]	160	200	200	250	250
Minimum spacing in non-cracked concrete	HST3	$s_{min}$ [mm]	120	90	90	125	180
	HST3-BW	for $c \geq$ [mm]	130	105	165	255	375
Minimum spacing in cracked concrete	HST3-R	$s_{min}$ [mm]	120	90	90	125	180
	HST3-R-BW	for $c \geq$ [mm]	130	105	165	205	375
Minimum spacing in cracked concrete	HST3	$s_{min}$ [mm]	90	90	90	125	140
	HST3-BW	for $c \geq$ [mm]	100	80	165	180	325
Min. edge distance in non-cracked concrete	HST3	$c_{min}$ [mm]	110	80	90	170	260
	HST3-BW	for $s \geq$ [mm]	170	160	140	295	400
Min. edge distance in cracked concrete	HST3-R	$c_{min}$ [mm]	110	80	120	150	260
	HST3-R-BW	for $s \geq$ [mm]	170	160	270	235	400
Critical spacing for splitting failure and concrete cone failure	HST3	$c_{min}$ [mm]	90	80	100	125	230
	HST3-BW	for $s \geq$ [mm]	115	90	240	240	295
Critical spacing for splitting failure and concrete cone failure	HST3-R	$c_{min}$ [mm]	90	80	100	125	230
	HST3-R-BW	for $s \geq$ [mm]	115	90	240	140	295
Critical spacing for splitting failure and concrete cone failure		$s_{cr,sp}$ [mm]	384		404	375	500
		$s_{cr,N}$ [mm]	303		303	375	375
Critical spacing for splitting failure and concrete cone failure		$c_{cr,sp}$ [mm]	192		202	188	250
		$c_{cr,N}$ [mm]	152		152	188	188

e) Data covered by ETA-98/0001 issue 2021-05-04.

f) Data covered by Hilti Technical Data

For spacing (edge distance) smaller than critical spacing (critical edge distance) the design loads have to be reduced.

\* ETA-98/0001 provides flexible edge & spacing values for each anchor layout configuration with M20 depending on base material thickness. Minimum spacing and edge distance values on the table are recommendations for specific anchor layout and base material dimensions. We kindly ask you to check your designs on PROFIS Engineering software to verify the edge & spacing values.

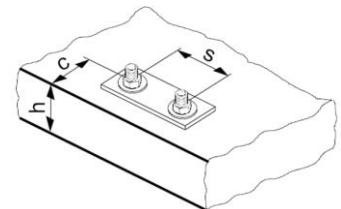



**Setting instructions**

\*For detailed information on installation see instruction for use given with the package of the product

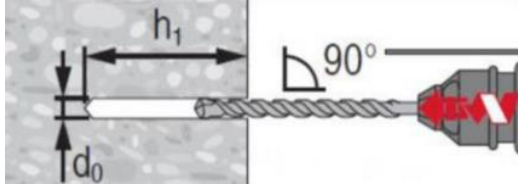
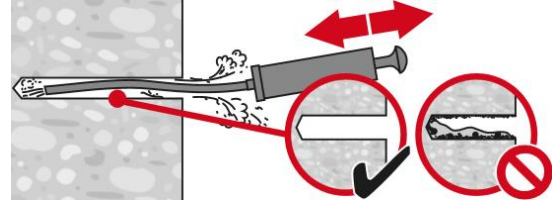
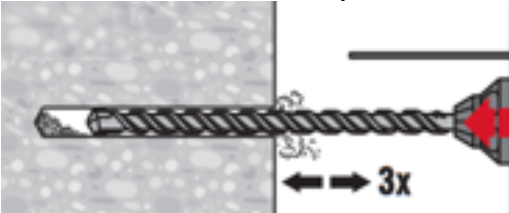
**Setting instruction for HST3 (-BW, -DN) / HST3-R (-BW, -DN) <sup>a)</sup>**
**Hammer drilling (M8, M10, M12, M16, M20, M24)**
**1. Drill the hole (+12 mm for non-cleaned holes)**

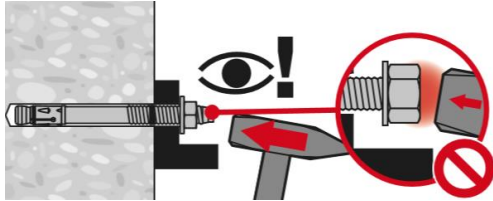
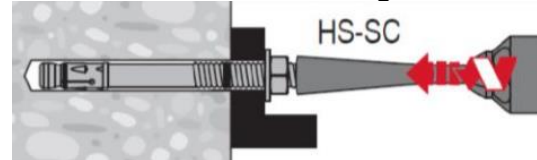
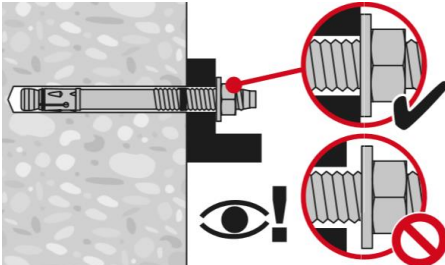
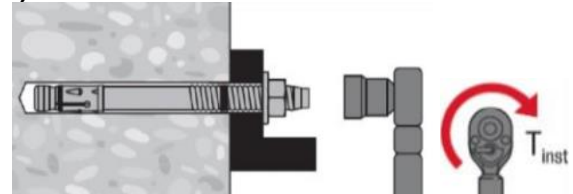
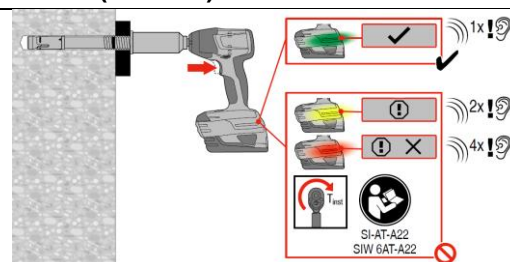
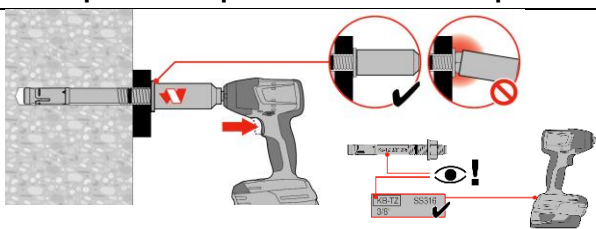
**2a. Clean the hole**

**2bi. Move the drill bit in & out (non-cleaned hole)**

**2bii. Check**

**3a. Insert the anchor with hammer**

**3b. Insert the anchor with setting tool HS-SC**

**4. Check**

**5a. Torque with calibrated torque wrench (M8-M24)**

**5b. Torque with impact wrench with Adaptive torque module (M8-M16) <sup>b)</sup>**

a) HST3 DN covers the diameter range between M8 and M16;

b) Equivalent combination of Hilti SIW + SI-AT tool, compatible to this anchor type, may be used (e.g. Hilti SIW 4AT-22 with SI-AT-22)



Hollow Drill Bit (M16, M20, M24), no cleaning is required even without buffer <sup>a)</sup>	
<b>1. Drill the hole with the Hollow drill bit</b> 	<b>2a. Insert the anchor with hammer</b> 
<b>2b. Insert the anchor with setting tool HS-SC</b> 	<b>3. Check</b> 
<b>5a. Torque with calibrated torque wrench (M8-M24)</b> 	<b>5b. Torque with impact wrench with Adaptive torque module (M8-M16) <sup>b)</sup></b> 

a) HST3 DN covers the diameter range between M8 and M16;

b) Equivalent combination of Hilti SIW + SI-AT tool, compatible to this anchor type, may be used (e.g. Hilti SIW 4AT-22 with SI-AT-22)

**Diamond coring (M8, M10, M12, M16, M20, M24) <sup>a)</sup>**

<p><b>1. Core the hole</b></p>	<p><b>2. Flushing</b></p>
<p><b>3. Clean the hole</b></p> <p>6 bar / 90 psi</p>	<p><b>4a. Insert the anchor with hammer</b></p>
<p><b>4b. Use a setting tool HS-SC</b></p> <p>HS-SC</p>	<p><b>5. Check</b></p>
<p><b>6a. Torque with calibrated torque wrench (M8-M24)</b></p> <p><math>T_{inst}</math></p>	<p><b>5b. Torque with impact wrench with Adaptive torque module (M8-M16) <sup>b)</sup></b></p> <p>SI-AT-A22 SIW 6AT-A22</p>

a) HST3 DN covers the diameter range between M8 and M16;

b) Equivalent combination of Hilti SIW + SI-AT tool, compatible to this anchor type, may be used (e.g. Hilti SIW 4AT-22 with SI-AT-22)

### 3.1.2 HST2

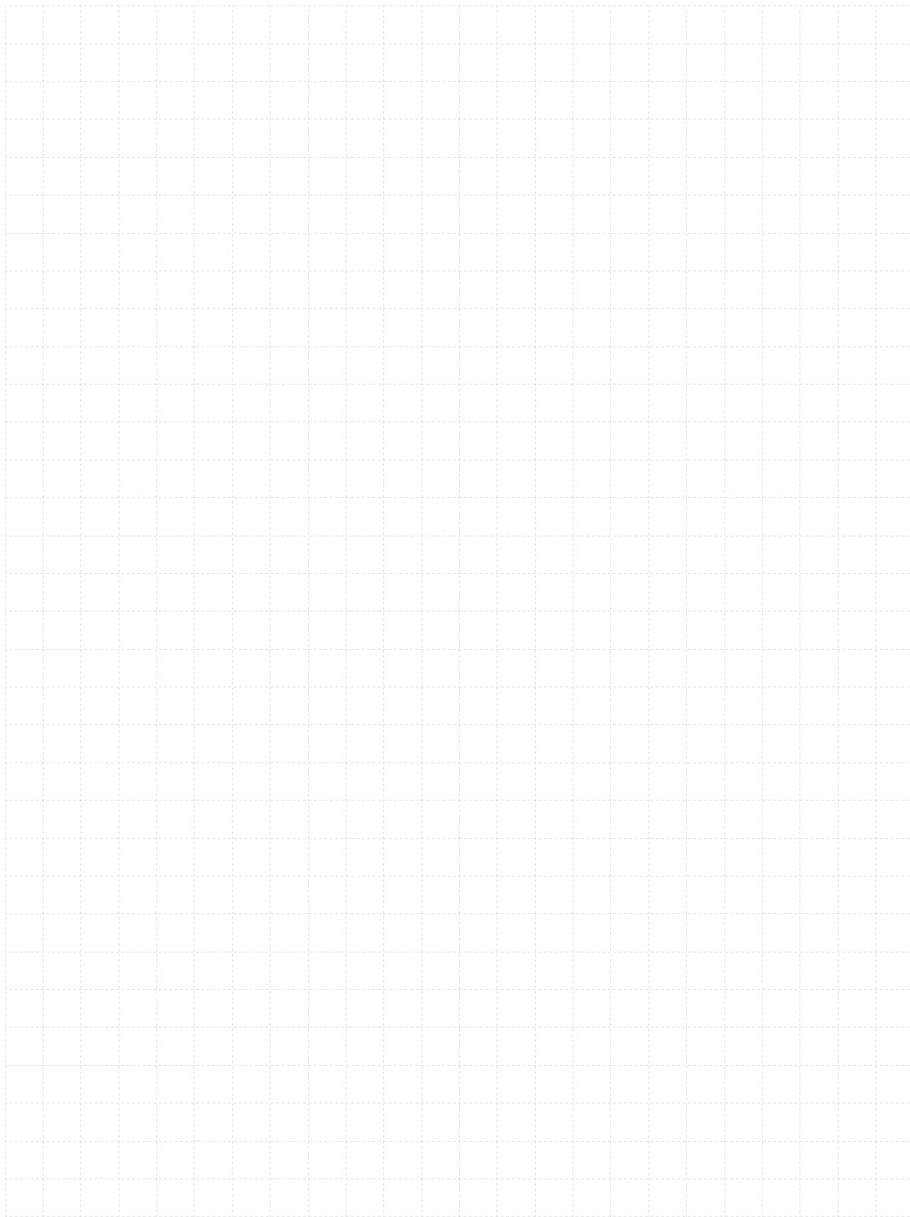

# HST2 Expansion anchor

Everyday standard expansion anchor for cracked concrete

## Anchor version



HST2  
HST2-R  
(M8-M16)

## Benefits

- Optimized expansion cone and wedge design combined with special steel and coatings.
- Suitable for non-cracked and cracked concrete
- Product and length identification mark facilitates quality control and inspection

## Base material



Concrete  
(non-cracked)



Concrete  
(cracked)

## Load conditions

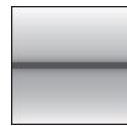

Static/  
quasi-static



Fire  
resistance



Seismic  
ETA-C1, C2

## Installation conditions

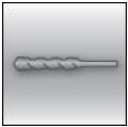

Hammer  
drilled holes



Diamond  
drilled holes

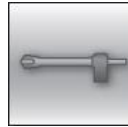

Hollow drill-  
bit drilling

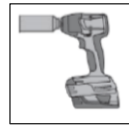

Impact wrench  
with adaptative  
torque module



European  
Technical  
Assessment



CE  
conformity



PROFIS  
Engineering  
design  
software



FM  
approved

## Approvals / certificates

Description	Authority / Laboratory	No. / date of issue
European technical assessment <sup>a)</sup>	DIBt, Berlin	ETA-15/0435 / 2022-11-16
Fire test report	DIBt, Berlin	ETA-15/0435 / 2022-11-16

a) All data given in this section according to ETA-15/0435, issue 2022-11-16

**Static and quasi-static loading (for a single anchor)**
**All data in this section applies to:**

- Correct setting (See setting instruction)
- No edge distance and spacing influence
- Steel failure
- Minimum base material thickness
- Concrete C 20/25,  $f_{ck,cube} = 25 \text{ N/mm}^2$

**Effective anchorage depth for static**

Anchor size			M8	M10	M12	M16
Effective anchorage depth	$h_{ef}$	[mm]	47	60	70	82

**Characteristic resistance**

Anchor size				M8	M10	M12	M16
<b>Non-cracked concrete</b>							
Tension	HST2	$N_{Rk}$	[kN]	9,0	16,0	20,0	35,0
	HST2-R			9,0	16,0	20,0	35,0
Shear	HST2	$V_{Rk}$	[kN]	11,4	21,6	31,4	55,3
	HST2-R			15,7	25,3	36,7	63,6
<b>Cracked concrete</b>							
Tension	HST2	$N_{Rk}$	[kN]	5,0	9,0	12,0	20,0
	HST2-R			5,0	9,0	12,0	25,0
Shear	HST2	$V_{Rk}$	[kN]	11,4	21,6	31,4	55,3
	HST2-R			15,7	25,3	36,7	63,6

**Design resistance**

Anchor size				M8	M10	M12	M16
<b>Non-cracked concrete</b>							
Tension	HST2	$N_{Rd}$	[kN]	6,0	10,7	13,3	23,3
	HST2-R			6,0	10,7	13,3	23,3
Shear	HST2	$V_{Rd}$	[kN]	9,1	17,3	25,1	44,2
	HST2-R			12,6	20,2	29,4	50,9
<b>Cracked concrete</b>							
Tension	HST2	$N_{Rd}$	[kN]	3,3	6,0	8,0	13,3
	HST2-R			3,3	6,0	8,0	16,7
Shear	HST2	$V_{Rd}$	[kN]	9,1	17,3	25,1	42,6
	HST2-R			12,6	20,2	29,4	42,6

**Recommended loads <sup>a)</sup>**

Anchor size				M8	M10	M12	M16
<b>Non-cracked concrete</b>							
Tension	HST2	$N_{rec}$	[kN]	4,3	7,6	9,5	16,7
	HST2-R			4,3	7,6	9,5	16,7
Shear	HST2	$V_{rec}$	[kN]	6,5	12,3	17,9	31,6
	HST2-R			9,0	14,5	21,0	36,3
<b>Cracked concrete</b>							
Tension	HST2	$N_{rec}$	[kN]	2,4	4,3	5,7	9,5
	HST2-R			2,4	4,3	5,7	11,9
Shear	HST2	$V_{rec}$	[kN]	6,5	12,3	17,9	30,4
	HST2-R			9,0	14,5	21,0	30,4

a) With overall partial safety factor for action  $\gamma = 1,4$ . The partial safety factors for action depend on the type of loading and shall be taken from national regulations.

### Seismic loading (for a single anchor)

#### All data in this section applies to:

- Correct setting (See setting instruction)
- No edge distance and spacing influence
- Steel failure
- Minimum base material thickness
- Concrete C 20/25,  $f_{ck,cube} = 25 \text{ N/mm}^2$
- $\alpha_{gap} = 1,0$  (using Hilti seismic filling set)

#### Effective anchorage depth for seismic

Anchor size		M10	M12	M16
Effective anchorage depth	$h_{ef}$ [mm]	60	70	82

#### Characteristic resistance in case of seismic performance C2

Anchor size				M10	M12	M16
Tension	HST2	$N_{Rk,seis}$	[kN]	3,3	10,0	12,8
Shear	HST2	$V_{Rk,seis}$	[kN]	16,0	24,2	41,3

#### Design resistance in case of seismic performance C2

Anchor size				M10	M12	M16
Tension	HST2	$N_{Rd,seis}$	[kN]	2,2	6,7	8,5
Shear	HST2	$V_{Rd,seis}$	[kN]	12,8	19,4	33,0

#### Characteristic resistance in case of seismic performance C1

Anchor size				M10	M12	M16
Tension	HST2	$N_{Rk,seis}$	[kN]	8,0	10,7	18,0
Shear	HST2	$V_{Rk,seis}$	[kN]	16,0	27,0	41,3

#### Design resistance in case of seismic performance C1

Anchor size				M10	M12	M16
Tension	HST2	$N_{Rd,seis}$	[kN]	5,3	7,1	12,0
Shear	HST2	$V_{Rd,seis}$	[kN]	12,8	21,6	33,0

## Fire resistance

### All data in this section applies to:

- Correct setting (See setting instruction)
- No edge distance and spacing influence
- Steel failure
- Minimum base material thickness
- Concrete C 20/25,  $f_{ck,cube} = 25 \text{ N/mm}^2$
- Hilti technical data for concrete strength class C55/67 to C80/95: for a structural element that fullfills the requirements according to DIN EN 1992-1-2 the fire resistance of C20/25 could be assumed.
- partial safety factor for resistance under fire exposure  $\gamma_{M,fi}=1,0$  (in absence of other national regulations)

### Effective anchorage depth for fire

Anchor size			M8	M10	M12	M16
Effective anchorage depth	$h_{ef}$	[mm]	47	60	70	82

### Characteristic resistance

Anchor size			M8	M10	M12	M16
<b>Fire Exposure R30</b>						
Tension	HST2	$N_{Rk,fi}$ [kN]	0,9	2,3	3,0	5,0
	HST2-R		0,9	2,3	3,0	5,0
Shear	HST2	$V_{Rk,fi}$ [kN]	0,9	2,5	5,0	9,0
	HST2-R		0,9	2,5	5,0	9,0
<b>Fire Exposure R120</b>						
Tension	HST2	$N_{Rk,fi}$ [kN]	0,5	0,7	1,0	2,0
	HST2-R		0,5	0,7	1,0	2,0
Shear	HST2	$V_{Rk,fi}$ [kN]	0,5	0,7	1,0	2,0
	HST2-R		0,5	0,7	1,0	2,0

### Design resistance

Anchor size			M8	M10	M12	M16
<b>Fire Exposure R30</b>						
Tension	HST2	$N_{Rd,fi}$ [kN]	0,9	2,3	3,0	5,0
	HST2-R		0,9	2,3	3,0	5,0
Shear	HST2	$V_{Rd,fi}$ [kN]	0,9	2,5	5,0	9,0
	HST2-R		0,9	2,5	5,0	9,0
<b>Fire Exposure R120</b>						
Tension	HST2	$N_{Rd,fi}$ [kN]	0,5	0,7	1,0	2,0
	HST2-R		0,5	0,7	1,0	2,0
Shear	HST2	$V_{Rd,fi}$ [kN]	0,5	0,7	1,0	2,0
	HST2-R		0,5	0,7	1,0	2,0

## Materials

### Mechanical properties

Anchor size			M8	M10	M12	M16
Nominal tensile strength	HST2	$f_{uk,thread}$ [N/mm <sup>2</sup> ]	660	730	710	720
	HST2-R		720	710	710	650
Yield strength	HST2	$f_{yk,thread}$ [N/mm <sup>2</sup> ]	528	584	568	576
	HST2-R		576	568	568	520
Stressed cross-section		$A_s$ [mm <sup>2</sup> ]	36,6	58,0	84,3	157
Moment of resistance		$W$ [mm <sup>3</sup> ]	31,2	62,3	109	277
Characteristic bending resistance	HST2	$M^{0Rk,s}$ [Nm]	25	55	93	240
	HST2-R		27	53	93	216

### Material quality

Part		Material
Expansion sleeve	HST2	Stainless steel A2
	HST2-R	Stainless steel A4
Bolt	HST2	Carbon steel, galvanized
	HST2-R	Stainless steel A4
Washer	HST2	Carbon steel, galvanized
	HST2-R	Stainless steel A4
Hexagon nut	HST2	Carbon steel, galvanized
	HST2-R	Stainless steel A4

### Anchor dimensions

Anchor size			M8	M10	M12	M16
Minimum thickness of fixture	$t_{fix,min}$	[mm]	2	2	2	2
Maximum thickness of fixture	$t_{fix,max}$	[mm]	195	200	200	235
Shaft diameter at the cone	$d_R$	[mm]	5,5	7,2	8,5	11,6
Minimum length of anchor	$l_{1,min} \geq$	[mm]	75	90	105	140
Maximum length of anchor	$l_{1,max} \leq$	[mm]	260	280	295	350
Length of expansion sleeve	$l_2$	[mm]	14,8	18,2	22,7	24,3

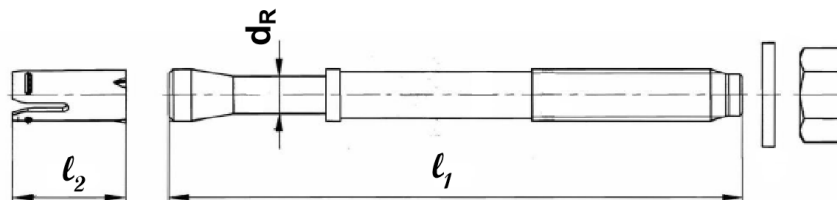



## Setting information

### Setting details

Anchor size		M8	M10	M12	M16
Nominal diameter of drill bit	$d_o$ [mm]	8	10	12	16
Cutting diameter of drill bit	$d_{cut} \leq$ [mm]	8,45	10,45	12,50	16,50
Effective embedment depth	$h_{ef}$ [mm]	47	60	70	82
Nominal embedment depth	$h_{nom}$ [mm]	55	69	80	95
Drill hole depth <sup>1)</sup>	$h_{1,1} \geq$ [mm]	60	74	88	103
	$h_{1,2} \geq$ [mm]	65	79	90	105
Diameter of clearance hole in the fixture	$d_f$ [mm]	9	12	14	18
Torque moment	$T_{inst}$ [Nm]	20	45	60	110
Width across	SW [mm]	13	17	19	24

1)  $h_{1,1}$  valid for hammer drilled holes and  $h_{1,2}$  valid for diamond drilled holes.

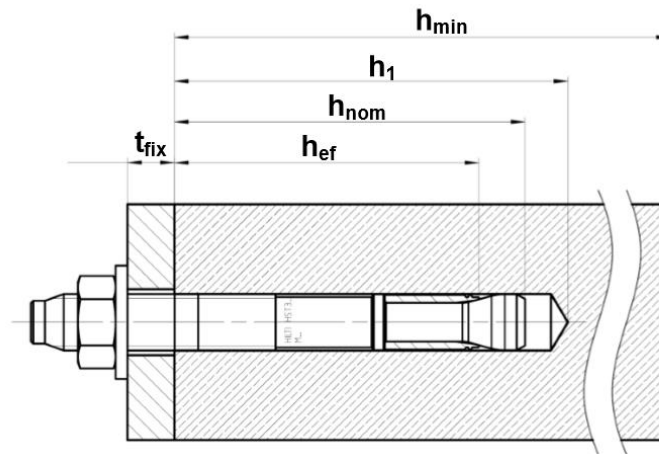

### Installation equipment

Anchor size	M8	M10	M12	M16
Rotary hammer	TE2 – TE16			
Diamond coring tool	DD – 30W, DD – EC1			
Hollow drill bit	-	-	TE – CD, TE – YD	
Other tools	hammer, torque wrench, blow out pump			

**Setting parameters**

Anchor Size		M8		M10		M12		M16		
Effective anchorage depth	$h_{ef}$ [mm]	47		60		70		82		
Minimum base material thickness	$h_{min}$ [mm]	$h_{min,1}$	$h_{min,2}$	$h_{min,1}$	$h_{min,2}$	$h_{min,1}$	$h_{min,2}$	$h_{min,1}$	$h_{min,2}$	
		100	80	120	100	140	120	160	140	
Minimum spacing in non-cracked concrete	HST2	$s_{min}$ [mm]	60	60	55	55	60	60	70	80
		for $c \geq$ [mm]	50	75	80	115	85	100	110	140
	HST2-R	$s_{min}$ [mm]	60	60	55	55	60	60	70	80
		for $c \geq$ [mm]	60	75	70	115	80	100	110	140
Minimum spacing in cracked concrete	HST2	$s_{min}$ [mm]	40	50	55	55	60	60	70	80
		for $c \geq$ [mm]	50	60	70	110	75	100	100	140
	HST2-R	$s_{min}$ [mm]	40	50	55	55	60	60	70	80
		for $c \geq$ [mm]	50	60	65	110	75	100	100	140
Minimum edge distance in non-cracked concrete	HST2	$c_{min}$ [mm]	50	70	55	70	55	70	85	80
		for $s \geq$ [mm]	60	80	115	110	145	130	150	180
	HST2-R	$c_{min}$ [mm]	60	70	50	70	55	70	70	80
		for $c \geq$ [mm]	60	80	115	110	145	130	160	180
Minimum edge distance in cracked concrete	HST2	$c_{min}$ [mm]	45	55	55	70	55	70	70	80
		for $s \geq$ [mm]	50	60	90	100	120	130	150	180
	HST2-R	$c_{min}$ [mm]	45	55	50	70	55	70	60	80
		for $c \geq$ [mm]	50	60	90	100	110	130	160	180
Critical spacing for splitting failure and concrete cone failure	$s_{cr,sp}$ [mm]	141		180		210		246		
	$s_{cr,N}$ [mm]									
Critical spacing for splitting failure and concrete cone failure	$c_{cr,sp}$ [mm]	71		90		105		123		
	$c_{cr,N}$ [mm]									

For spacing (edge distance) smaller than critical spacing (critical edge distance) the design loads have to be reduced.

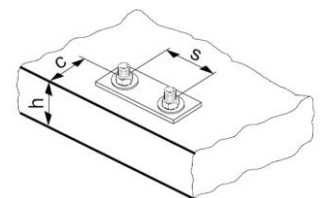

**Setting instructions**

\*For detailed information on installation see instruction for use given with the package of the product

Setting instruction	
Hammer drilling	
<b>1. Drill the hole</b> 	<b>2. Clean the hole</b> 
<b>3a. Insert the anchor with hammer</b> 	<b>3a. Insert the anchor with setting tool HS-SC (M8-M16)</b> 
<b>4. Check</b> 	<b>5a. Torque with calibrated torque wrench (M8-M16)</b> 
<b>5b. Torque with impact wrench with Adaptive torque module (M8-M12) a)</b> 	

a) Equivalent combination of Hilti SIW + SI-AT tool, compatible to this anchor type, may be used (e.g. Hilti SIW 4AT-22 with SI-AT-22)

**Hollow Drill Bit, no cleaning required**

**1. Drill the hole with the Hollow drill bit**

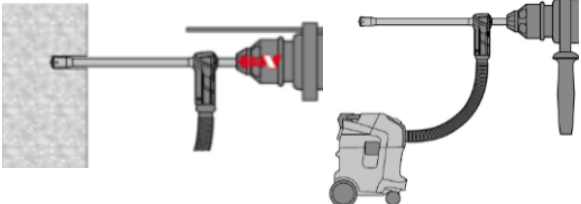

**2a. Insert the anchor with hammer**

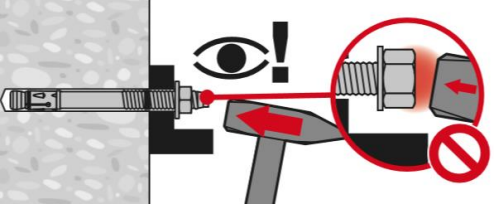

**2a. Insert the anchor with setting tool HS-SC**

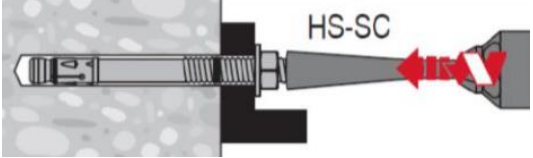

**3. Check**

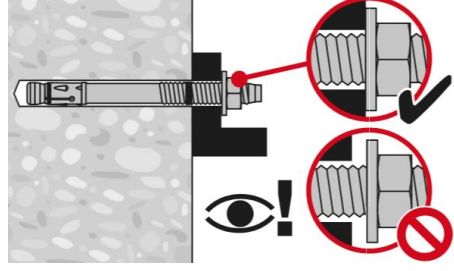

**4a. Torque with calibrated torque wrench (M8-M16)**

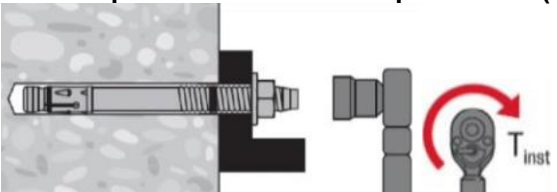

**4b. Torque with impact wrench with Adaptive torque module (M8-M12) a)**

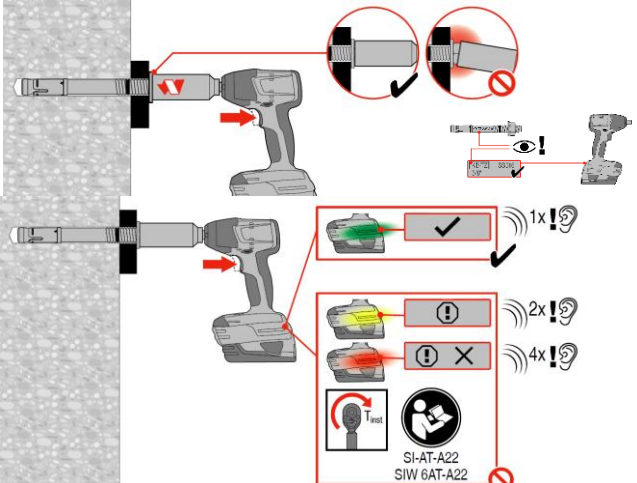

a) Equivalent combination of Hilti SIW + SI-AT tool, compatible to this anchor type, may be used (e.g. Hilti SIW 4AT-22 with SI-AT-22)

**Diamond coring**

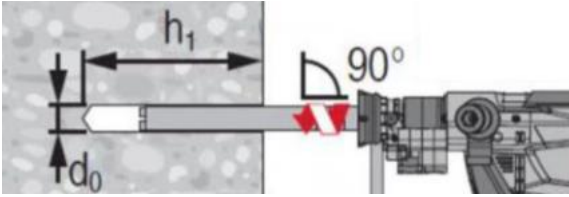
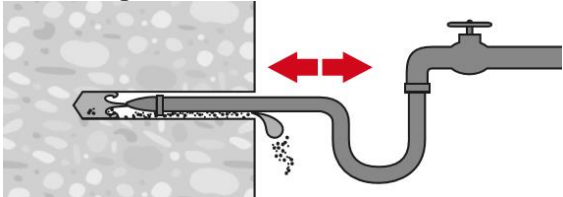
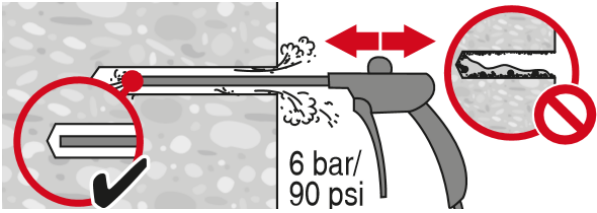
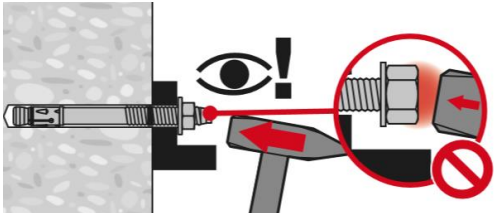
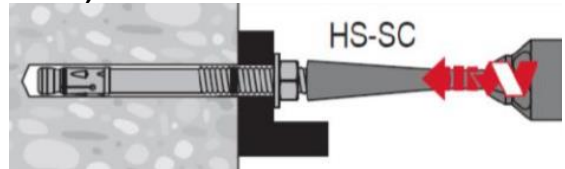
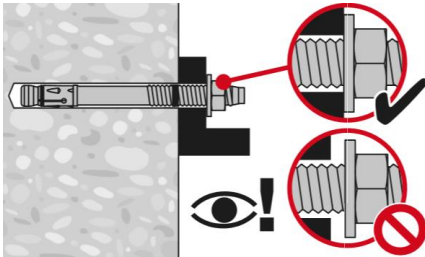
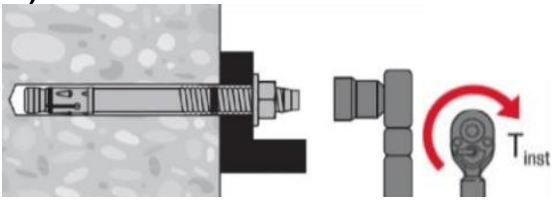
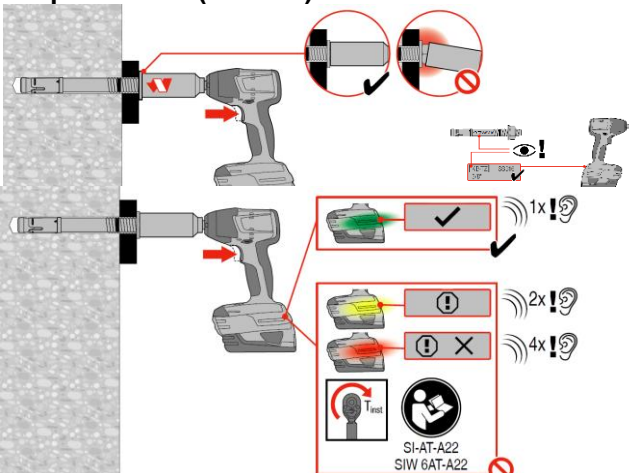
<p><b>1. Core the hole</b></p> 	<p><b>2. Flushing</b></p> 
<p><b>3. Clean the hole</b></p>  <p>6 bar/ 90 psi</p>	<p><b>4a. Insert the anchor with hammer</b></p> 
<p><b>4b. Insert the anchor with setting tool HS-SC (M8-M16)</b></p>  <p>HS-SC</p>	<p><b>5. Check</b></p> 
<p><b>6a. Torque with calibrated torque wrench (M8-M16)</b></p>  <p><math>T_{inst}</math></p>	<p><b>6b. Torque with impact wrench with Adaptive torque module (M8-M12)</b></p>  <p>SI-AT-A22 SIW 6AT-A22</p>

### 3.1.3 HSA



 **Go back to the table of content**  
Push this button

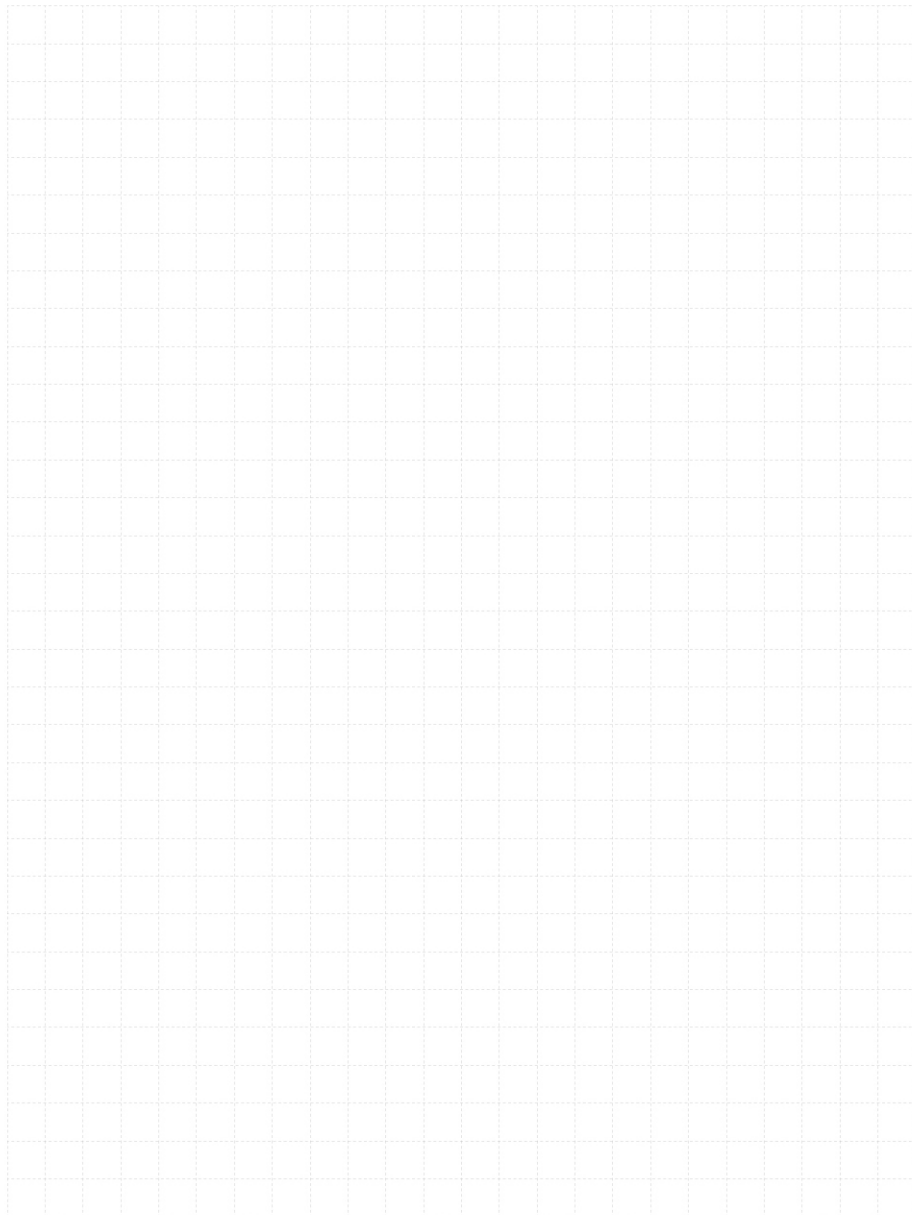

 **Go back to the anchor selector**  
Push this button







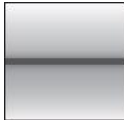

# HSA Expansion anchor

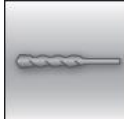
Everyday standard expansion anchor for uncracked concrete

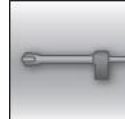
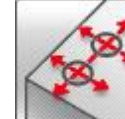
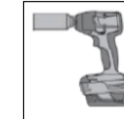
Anchor version	Benefits
 <p>HSA HSA-F HSA-R HSA-R2 (M6-M20)</p>	<ul style="list-style-type: none"> <li>- Fast &amp; convenient setting behaviour</li> <li>- Reliable ETA approved torquing using impact wrench with the innovative SIW 6AT-A22 and SI-AT-A22 system for automatic torquing</li> <li>- Small edge and spacing distances</li> <li>- High loads</li> <li>- Three embedment depths for maximal design flexibility</li> </ul>
 <p>HSA-BW (M6-M20)</p>	<ul style="list-style-type: none"> <li>- M10, M12, M16 and M20 ETA approved for diamond cored holes using DD 30-W and matching diamond core bit</li> <li>- Suitable for pre- and through fastening</li> <li>- Long lengths available suitable for wood structures fastening applications</li> </ul>

Base material	Load conditions
 <p>Concrete (non-cracked)</p>	  <p>Static/ quasi- static</p> <p>Fire resistance</p>

Installation conditions	Other information
     <p>Hammer drilled holes</p> <p>Diamond drilled holes</p> <p>Hollow drill- bit drilling</p> <p>Small edge distance and spacing</p> <p>Impact wrench with adaptative torque module</p>	    <p>European Technical Assessment</p> <p>CE conformity</p> <p>PROFIS Engineering design software</p> <p>Corrosion resistance</p>

## Approvals / certificates

Description	Authority / Laboratory	No. / date of issue
European technical assessment <sup>a)</sup>	DIBt, Berlin	ETA-11/0374 / 2022-11-03

a) All data given in this section according to ETA-11/0374, issued 2022-11-03.



**Static and quasi-static loading (for a single anchor)**
**All data in this section applies to:**

- Correct setting (See setting instruction)
- No edge distance and spacing influence
- Steel failure
- Minimum base material thickness
- Concrete C 20/25

**Effective anchorage depth**

Anchor size			M6			M8			M10		
Effective anchorage depth	$h_{ef}$	[mm]	30	40	60	30	40	70	40	50	80
Anchor size			M12			M16			M20		
Effective anchorage depth	$h_{ef}$	[mm]	50	65	100	65	80	120	75	100	115

**Characteristic resistance**

Anchor size			M6			M8			M10		
Effective anchorage depth	$h_{ef}$	[mm]	30	40	60	30	40	70	40	50	80
Tension	HSA, HSA-BW	$N_{Rk}$ [kN]	6,0	7,5	9,0	8,1	12,4	16,0	12,4	17,4	25,0
	HSA-R2, HSA-R		6,0	7,5	9,0	8,1	12,4	16,0	12,4	17,4	25,0
	HSA-F		6,0	7,5	9,0	8,1	12,4	15,9	12,4	17,4	25,0
Shear	HSA, HSA-BW	$V_{Rk}$ [kN]	6,5	6,5	6,5	8,1	10,6	10,6	18,9	18,9	18,9
	HSA-R2, HSA-R		7,2	7,2	7,2	8,1	12,3	12,3	22,6	22,6	22,6
	HSA-F		6,5	6,5	6,5	8,1	10,6	10,6	18,9	18,9	18,9
Anchor size			M12			M16			M20		
Effective anchorage depth	$h_{ef}$	[mm]	50	65	100	65	80	120	75	100	115
Tension	HSA, HSA-BW	$N_{Rk}$ [kN]	17,4	25,8	35,0	25,8	35,2	50,0	32,0	49,2	60,7
	HSA-R2, HSA-R		17,4	25,8	35,0	25,8	35,2	50,0	32,0	49,2	60,7
	HSA-F		17,4	25,8	35,0	25,8	35,2	50,0	32,0 <sup>a)</sup>	49,2 <sup>a)</sup>	60,7 <sup>a)</sup>
Shear	HSA, HSA-BW	$V_{Rk}$ [kN]	29,5	29,5	29,5	51,0	51,0	51,0	63,9	85,8	85,5
	HSA-R2, HSA-R		29,3	29,3	29,3	56,5	56,5	56,5	63,9	91,9	91,9
	HSA-F		29,5	29,5	29,5	51,0	51,0	51,0	63,9 <sup>a)</sup>	68,6 <sup>a)</sup>	68,6 <sup>a)</sup>

a) Data covered by Hilti Technical Data.

**Design resistance**

Anchor size			M6			M8			M10		
Effective anchorage depth	$h_{ef}$	[mm]	30	40	60	30	40	70	40	50	80
Tension	HSA, HSA-BW	$N_{Rd}$ [kN]	4,0	5,0	6,0	5,4	8,3	10,7	8,3	11,6	16,7
	HSA-R2, HSA-R		4,0	5,0	6,0	5,4	8,3	10,7	8,3	11,6	16,7
	HSA-F		4,0	5,0	6,0	5,4	8,3	10,7	8,3	11,6	16,7
Shear	HSA, HSA-BW	$V_{Rd}$ [kN]	5,2	5,2	5,2	5,4	8,5	8,5	15,1	15,1	15,1
	HSA-R2, HSA-R		5,8	5,8	5,8	5,4	9,8	9,8	18,1	18,1	18,1
	HSA-F		5,2	5,2	5,2	5,4	8,5	8,5	15,1	15,1	15,1
Anchor size			M12			M16			M20		
Effective anchorage depth	$h_{ef}$	[mm]	50	65	100	65	80	120	75	100	115
Tension	HSA, HSA-BW	$N_{Rd}$ [kN]	11,6	17,2	23,3	17,2	23,5	33,3	21,3	32,8	40,4
	HSA-R2, HSA-R		11,6	17,2	23,3	17,2	23,5	33,3	21,3	32,8	40,4
	HSA-F		11,6	17,2	23,3	17,2	23,5	33,3	21,3 <sup>a)</sup>	32,8 <sup>a)</sup>	40,4 <sup>a)</sup>
Shear	HSA, HSA-BW	$V_{Rd}$ [kN]	23,2	23,6	23,6	40,8	40,8	40,8	42,6	68,6	68,4
	HSA-R2, HSA-R		23,2	23,4	23,4	45,2	45,2	45,2	42,6	73,5	73,5
	HSA-F		23,2	23,6	23,6	40,8	40,8	40,8	42,6 <sup>a)</sup>	54,9 <sup>a)</sup>	54,9 <sup>a)</sup>

a) Data covered by Hilti Technical Data.



**Recommended loads <sup>a)</sup>**

Anchor size			M6			M8			M10		
Effective anchorage depth	$h_{ef}$	[mm]	30	40	60	30	40	70	40	50	80
Tension	HSA, HSA-BW		2,9	3,6	4,3	3,8	5,9	7,6	5,9	8,3	11,9
	HSA-R2, HSA-R		2,9	3,6	4,3	3,8	5,9	7,6	5,9	8,3	11,9
	HSA-F		2,9	3,6	4,3	3,8	5,9	7,6	5,9	8,3	11,9
Shear	HSA, HSA-BW		3,7	3,7	3,7	3,8	6,1	6,1	10,8	10,8	10,8
	HSA-R2, HSA-R		4,1	4,1	4,1	3,8	7,0	7,0	12,9	12,9	12,9
	HSA-F		3,7	3,7	3,7	3,8	6,1	6,1	10,8	10,8	10,8
Anchor size			M12			M16			M20		
Effective anchorage depth	$h_{ef}$	[mm]	50	65	100	65	80	120	75	100	115
Tension	HSA, HSA-BW		8,3	12,3	16,7	12,3	16,8	23,8	15,2	23,4	28,9
	HSA-R2, HSA-R		8,3	12,3	16,7	12,3	16,8	23,8	15,2	23,4	28,9
	HSA-F		8,3	12,3	16,7	12,3	16,8	23,8	15,2 <sup>b)</sup>	23,4 <sup>b)</sup>	28,9 <sup>b)</sup>
Shear	HSA, HSA-BW		16,6	16,9	16,9	29,1	29,1	29,1	30,4	49,0	48,9
	HSA-R2, HSA-R		16,6	16,7	16,7	32,3	32,3	32,3	30,4	52,5	52,5
	HSA-F		16,6	16,9	16,9	29,1	29,1	29,1	30,4 <sup>b)</sup>	39,2 <sup>b)</sup>	39,2 <sup>b)</sup>

a) With overall partial safety factor for action  $\gamma = 1,4$ . The partial safety factors for action depend on the type of loading and shall be taken from national regulations.

b) Data covered by Hilti Technical data

**Materials**
**Mechanical properties**

Anchor size			M6	M8	M10	M12	M16	M20
Nominal tensile strength	HSA, HSA-BW, HSA-F		650	580	650	700	650	700
	HSA-R2, HSA-R		650	560	650	580	600	625
Yield strength	HSA, HSA-BW, HSA-F		520	464	520	560	520	560
	HSA-R2, HSA-R		520	448	520	464	480	500
Stressed cross-section	$A_s$	[mm <sup>2</sup> ]	20,1	36,6	58	84,3	157	245
Moment of resistance	$W$	[mm <sup>3</sup> ]	12,7	31,2	62,3	109,2	277,5	540,9
Characteristic bending resistance	HSA, HSA-BW, HSA-F		9,9	21,7	48,6	91,7	216,4	454,4
	HSA-R2, HSA-R		9,9	21	48,6	76	199,8	405,7

**Material quality**

Part		Material
HSA HSA-BW	Bolt	Carbon steel, 18MnV5 or 1.0511 or 1.0501 / Galvanized ( $\geq 5 \mu\text{m}$ )
	Sleeve	Carbon steel, 1.0347 / Galvanized ( $\geq 5 \mu\text{m}$ )
	Washer	Carbon steel, DIN 125 strength class 140HV / Galvanized ( $\geq 5 \mu\text{m}$ )
	Hexagon nut	Carbon steel, DIN 934 strength class 8 / Galvanized ( $\geq 5 \mu\text{m}$ )
HSA-R2	Bolt	Stainless steel A2, 1.4301
	Sleeve	Stainless steel A2, 1.4301
	Washer	Stainless steel A2, DIN 125 strength class 140HV
	Hexagon nut	Stainless steel A2, DIN 934 strength class 8
HSA-R	Bolt	Stainless steel A4, 1.4401 or Duplex steel, 1.4362
	Sleeve	Stainless steel A2, 1.4301
	Washer	Stainless steel A4, DIN 125 strength class 140HV
	Hexagon nut	Stainless steel A4, DIN 934 strength class 8
HSA-F	Bolt	Carbon steel, 18MnV5 or 1.0501 or 1.1172 / Hot-dip galvanized ( $\geq 42 \mu\text{m}$ )
	Sleeve	Stainless steel A2, 1.4301
	Washer	Carbon steel, DIN 125 strength class 140HV / Hot-dip galvanized ( $\geq 42 \mu\text{m}$ )
	Hexagon nut	Carbon steel, DIN 934 strength class 8 / Hot-dip galvanized ( $\geq 42 \mu\text{m}$ )

**Washer dimensions**

Anchor size		M6	M8	M10	M12	M16	M20
<b>Inner diameter d</b>							
HSA, HSA-R2, HSA-R, HSA-F	[mm]	6,4	8,4	10,5	13,0	17,0	21
HSA-BW, HSA-R2	[mm]	6,4	8,4	10,5	13,0	17,0	22
<b>Outer diameter D</b>							
HSA, HSA-R2, HSA-R, HSA-F	[mm]	12,0	16,0	20,0	24,0	30,0	37,0
HSA-BW, HSA-R2	[mm]	18,0	24,0	30,0	37,0	50,0	60,0
<b>Thickness h</b>							
HSA, HSA-R2, HSA-R, HSA-F	[mm]	1,6	1,6	2,0	2,5	3,0	3,0
HSA-BW, HSA-R2	[mm]	1,8	2,0	2,5	3,0	3,0	4,0

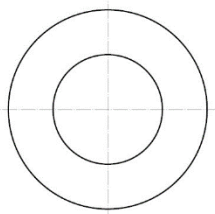
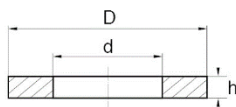

**Nut dimensions – according to DIN 934**

Anchor size			M6	M8	M10	M12	M16	M20
Dimension	s	[mm]	10	13	17	19	24	30
Dimension	e	[mm]	11.05	14.38	18.90	21.10	26.75	32.95
Thickness	m	[mm]	5	6.5	8	10	13	16

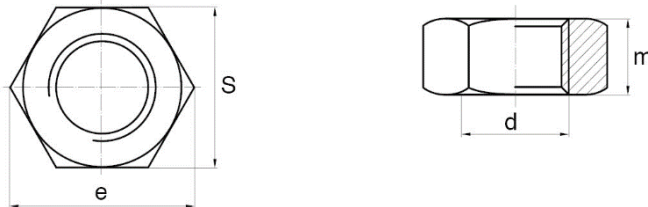
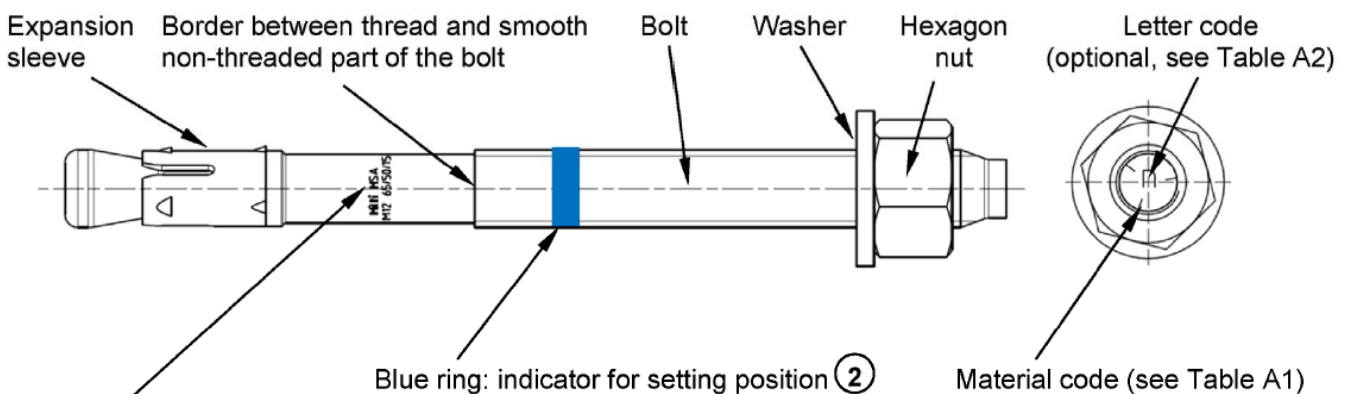
**Product marking and identification of anchor:**
**Product description: Hilti metal expansion anchor HSA, HSA-BW, HSA-F, HSA-R2 and HSA-R**

**Marking:**

 Hilti HSA M...  $t_{fix,1}/t_{fix,2}/t_{fix,3}$ 

 Brand and metal expansion anchor type as well as metal expansion anchor size and max. fixture thicknesses  $t_{fix,1}/t_{fix,2}/t_{fix,3}$ 
**Material code for identification of different materials**

Type	HSA, HSA-BW, HSA-F (carbon steel)	HSA-R2 (Stainless steel grade A2)	HSA-R (stainless steel grade A4)
Material code			
	Letter code without mark	Letter code with two marks	Letter code with three marks

**Letter code for anchor length (optional) and maximum thickness of the fixture  $t_{fix}$** 

Type	HSA, HSA-BW, HSA-R2, HSA-R, HSA-F					
Size	M6	M8	M10	M12	M16	M20
$h_{nom}$ [mm]	37 / 47 / 67	39 / 49 / 79	50 / 60 / 90	64 / 79 / 114	77 / 92 / 132	90 / 115 / 130
Letter	$t_{fix}$	$t_{fix,1}/t_{fix,2}/t_{fix,3}$	$t_{fix,1}/t_{fix,2}/t_{fix,3}$	$t_{fix,1}/t_{fix,2}/t_{fix,3}$	$t_{fix,1}/t_{fix,2}/t_{fix,3}$	$t_{fix,1}/t_{fix,2}/t_{fix,3}$
<b>z</b>	<b>5/-/-</b>	<b>5/-/-</b>	<b>5/-/-</b>	<b>5/ -/-</b>	<b>5/-/-</b>	5/-/-
<b>y</b>	10/-/-	10/-/-	10/-/-	10/-/-	10/-/-	<b>10/-/-</b>
<b>x</b>	15/5/-	15/5/-	15/5/-	15/-/-	15/-/-	15/-/-
<b>w</b>	<b>20/10/-</b>	<b>20/10/-</b>	<b>20/10/-</b>	<b>20/5/-</b>	<b>20/5/-</b>	20/-/-
<b>v</b>	25/15/-	25/15/-	25/15	25/10/-	25/10/-	25/-/-
<b>u</b>	30/20/-	30/20/-	30/20/-	30/15/-	30/15/-	30/5/-
<b>t</b>	35/25/5	<b>35/25/-</b>	<b>35/25/-</b>	<b>35/20/-</b>	35/20/-	35/10/-
<b>s</b>	<b>40/30/10</b>	40/30/-	40/30/-	40/25/-	<b>40/25/-</b>	40/15/-
<b>r</b>	45/35/15	45/35/5	45/35/5	45/30/-	45/30/-	45/20/5
<b>q</b>	50/40/20	50/40/10	<b>50/40/10</b>	50/35/-	50/35/-	50/25/10
<b>p</b>	<b>55/45/25</b>	<b>55/45/15</b>	55/45/15	55/40/5	55/40/-	<b>55/30/15</b>
<b>o</b>	60/50/30	60/50/20	60/50/20	60/45/10	60/45/5	60/35/20
<b>n</b>	65/55/35	65/55/25	65/55/25	<b>65/50/15</b>	65/50/10	65/40/25
<b>m</b>	70/60/40	70/60/30	<b>70/60/30</b>	70/55/20	70/55/15	70/45/30
<b>l</b>	75/65/45	75/65/35	75/65/35	75/60/25	75/60/20	75/50/35
<b>k</b>	80/70/50	<b>80/70/40</b>	80/70/40	80/65/30	80/65/25	80/55/40
<b>j</b>	85/75/55	85/75/45	85/75/45	85/70/35	<b>85/70/30</b>	85/60/45
<b>i</b>	90/80/60	90/80/50	<b>90/80/50</b>	90/75/40	90/75/35	90/65/50
<b>h</b>	95/85/65	95/85/55	95/85/55	<b>95/80/45</b>	95/80/40	95/70/55
<b>g</b>	100/90/70	100/90/60	100/90/60	100/85/50	100/85/45	100/75/60
<b>f</b>	105/95/75	105/95/65	<b>105/95/65</b>	105/90/55	105/90/50	105/80/65
<b>e</b>	110/100/80	110/100/70	110/100/70	110/95/60	110/95/55	110/85/70
<b>d</b>	115/105/85	115/105/75	115/105/75	115/100/65	115/100/60	115/90/75
<b>c</b>	120/110/90	120/110/80	120/110/80	<b>125/110/75</b>	120/105/65	120/95/80
<b>b</b>	125/115/95	125/115/85	125/115/85	135/120/85	125/110/70	125/100/85
<b>a</b>	130/120/100	130/120/90	130/120/90	<b>145/130/95</b>	<b>135/120/80</b>	130/105/90
<b>aa</b>	-	-	-	155/140/105	145/130/90	-
<b>ab</b>	-	-	-	165/150/115	155/140/100	-
<b>ac</b>	-	-	-	175/160/125	165/150/110	-
<b>ad</b>	-	-	-	180/165/130	190/175/135	-
<b>ae</b>	-	-	-	230/215/180	240/225/185	-
<b>af</b>	-	-	-	280/265/230	290/275/235	-
<b>ag</b>	-	-	-	330/315/280	340/325/285	-

Anchor length in bolt type and grey shaded are standard items. For selection of other anchor length, check availability of the items.

**Setting information**
**Setting details**

Anchor size		M6			M8			M10		
Nominal anchorage depth	$h_{nom}$ [mm]	37	47	67	39	49	79	50	60	90
Minimum base material thickness	$h_{min}$ [mm]	100	100	120	100	100	120	100	120	160
Minimum spacing	$s_{min}$ [mm]	35	35	35	35	35	35	50	50	50
Minimum edge distance	$c_{min}$ [mm]	35	35	35	40	35	35	50	40	40
Nominal diameter of drill bit	$d_0$ [mm]	6			8			10		
Cutting diameter of drill bit	$d_{cut} \leq$ [mm]	6,4			8,45			10,45		
Depth of drill hole	$h_1 \geq$ [mm]	42	52	72	44	54	84	55	65	95
Diameter of clearance hole in the fixture	$d_r \leq$ [mm]	7			9			12		
Torque moment	$T_{inst}$ [Nm]	5			15			25		
Width across flats	SW [mm]	10			13			17		
Anchor size		M12			M16			M20		
Nominal anchorage depth	$h_{nom}$ [mm]	64	79	114	77	92	132	90	115	130
Minimum base material thickness	$h_{min}$ [mm]	100	140	180	140	160	180	160	220	220
Minimum spacing	$s_{min}$ [mm]	70	70	70	90	90	90	195	175	175
Minimum edge distance	$c_{min}$ [mm]	70	65	55	80	75	70	130	120	120
Nominal diameter of drill bit	$d_0$ [mm]	12			16			20		
Cutting diameter of drill bit	$d_{cut} \leq$ [mm]	12,5			16,5			20,55		
Depth of drill hole	$h_1 \geq$ [mm]	72	87	122	85	100	140	98	123	138
Diameter of clearance hole in the fixture	$d_r \leq$ [mm]	14			18			22		
Torque moment	$T_{inst}$ [Nm]	50			80			200		
Width across flats	SW [mm]	19			24			30		

For spacing (edge distance) smaller than critical spacing (critical edge distance) the design loads have to be reduced.

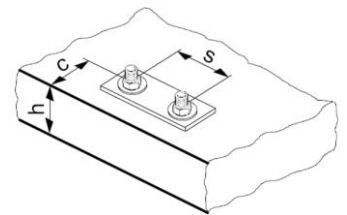

**Installation equipment**

Anchor size		M6	M8	M10	M12	M16	M20	
<b>Drilling</b>								
Rotary hammer		TE2 – TE30					TE40 – TE80	
- With hammer drilling (HD)		✓	✓	✓	✓	✓	✓	
- With Hilti hollow drill bits (HDB) TE-CD, TE-YD		-			✓	✓	✓	
Diamond coring (DD) with DD-30W and C+...SPX-T (abrasive) core bits		-		✓	✓	✓	✓	
<b>Borehole cleaning</b>								
Manual cleaning: hand blow out pump		✓	✓	✓	✓	✓	✓	
Automatic cleaning: rotary hammer with Hilti TE-CD and TE-YD drilling system including Hilti Vacuum Cleaner (VC)		-	-	-	✓	✓	✓	
<b>Anchor setting</b>								
Manual setting: hammer		✓	✓	✓	✓	✓	✓	
Machine setting: rotary hammer with setting tool HS-SC		-	✓	✓	✓	✓	-	
<b>Application of the torque moment</b>								
Manual: calibrated torque wrench		✓	✓	✓	✓	✓	✓	
Automatic: impact wrench with S-TB HSA torque bar		-	Hilti SIW 14-A Hilti SIW 22-A / Hilti SIW 6AT-A22			Hilti SIW 22T-A / Hilti SIW 6AT-A22		-
Speed setting of impact wrench	HSA, HSA-BW, HSA-F	-	1		3	- <sup>1)</sup>	-	
	HSA-R2, HSA-R	-	3		3	- <sup>1)</sup>	-	
Setting time $t_{set}$ [sec]		-	4				-	
Automatic: impact wrench with SIW 6AT-A22 and SI-AT-A22 adaptive torque module		-	✓	✓	✓	✓	-	

1) The impact wrench operates with a fixed speed.

**Setting parameters**

Anchor size			M6			M8			M10		
Nominal anchorage depth	$h_{nom}$	[mm]	37	47	67	39	49	79	50	60	90
Effective anchorage depth	$h_{ef}$	[mm]	30	40	60	30	40	70	40	50	80
Critical spacing for splitting failure	$s_{cr,sp}$	[mm]	100	120	130	130	180	200	190	210	290
Critical edge distance for splitting failure	$c_{cr,sp}$	[mm]	50	60	65	65	90	100	95	105	145
Critical spacing for concrete cone failure	$s_{cr,N}$	[mm]	90	120	180	90	120	210	120	150	240
Critical edge distance for concrete cone failure	$c_{cr,N}$	[mm]	45	60	90	45	60	105	60	75	120
Anchor size			M12			M16			M20		
Nominal anchorage depth	$h_{nom}$	[mm]	64	79	114	77	92	132	90	115	130
Effective anchorage depth	$h_{ef}$	[mm]	50	65	100	65	80	120	75	100	115
Critical spacing for splitting failure	$s_{cr,sp}$	[mm]	200	250	310	230	280	380	260	370	400
Critical edge distance for splitting failure	$c_{cr,sp}$	[mm]	100	125	155	115	140	190	130	185	200
Critical spacing for concrete cone failure	$s_{cr,N}$	[mm]	150	195	300	195	240	360	225	300	345
Critical edge distance for concrete cone failure	$c_{cr,N}$	[mm]	75	97,5	150	97,5	120	180	112,5	150	172,5

**Setting instructions**

\*For detailed information on installation see instruction for use given with the package of the product

1. Hole drilling		
<b>Hammer drilling (HD): M6-M20</b> 	<b>Hammer drilling with Hilti hollow drill bit (HDB): M12-M20</b> 	<b>Diamond drilling (DD): M10-M20</b> 
2. Cleaning		
<b>Manual cleaning (MC): M6-M20</b> 	<b>Automatic cleaning (AC): M12-M20</b> 	

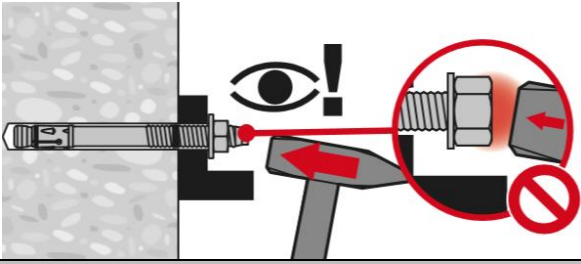
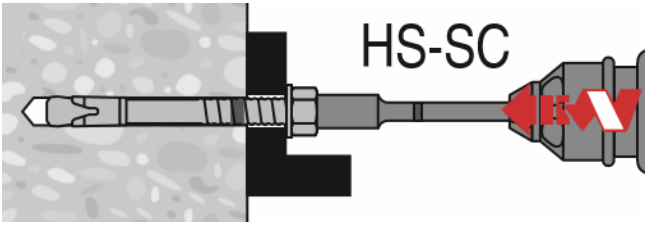
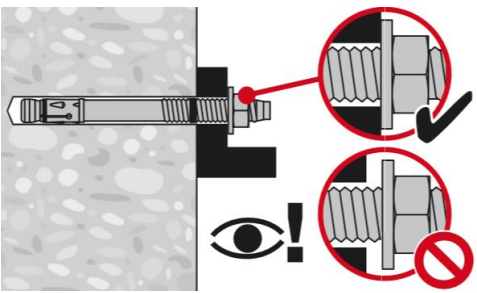
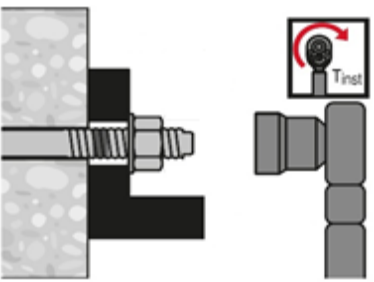
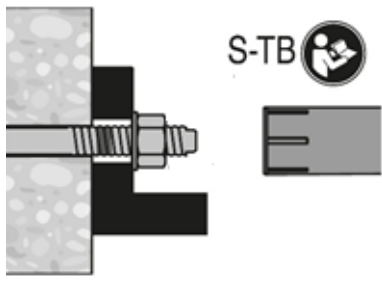
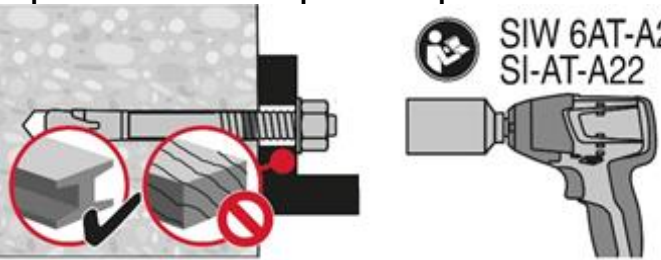
<b>3. Anchor setting</b>	
<p><b>Hammer setting: M6-M20</b></p> 	<p><b>Machine setting (impact screw driver with setting tool): M8-M16</b></p> 
<b>4. Check setting</b>	
	
<b>5. Anchor torqueing</b>	
<p><b>Torque wrench: M6-M20</b></p> 	<p><b>Impact screw driver with setting tool (only for HSA-F)</b></p> 
<p><b>Impact wrench with adaptative torque module <sup>a)</sup></b></p>  <p style="margin-left: 200px;">SIW 6AT-A22+ SI-AT-A22</p>	

a) Equivalent combination of Hilti SIW + SI-AT tool, compatible to this anchor type, may be used (e.g. Hilti SIW 4AT-22 with SI-AT-22)



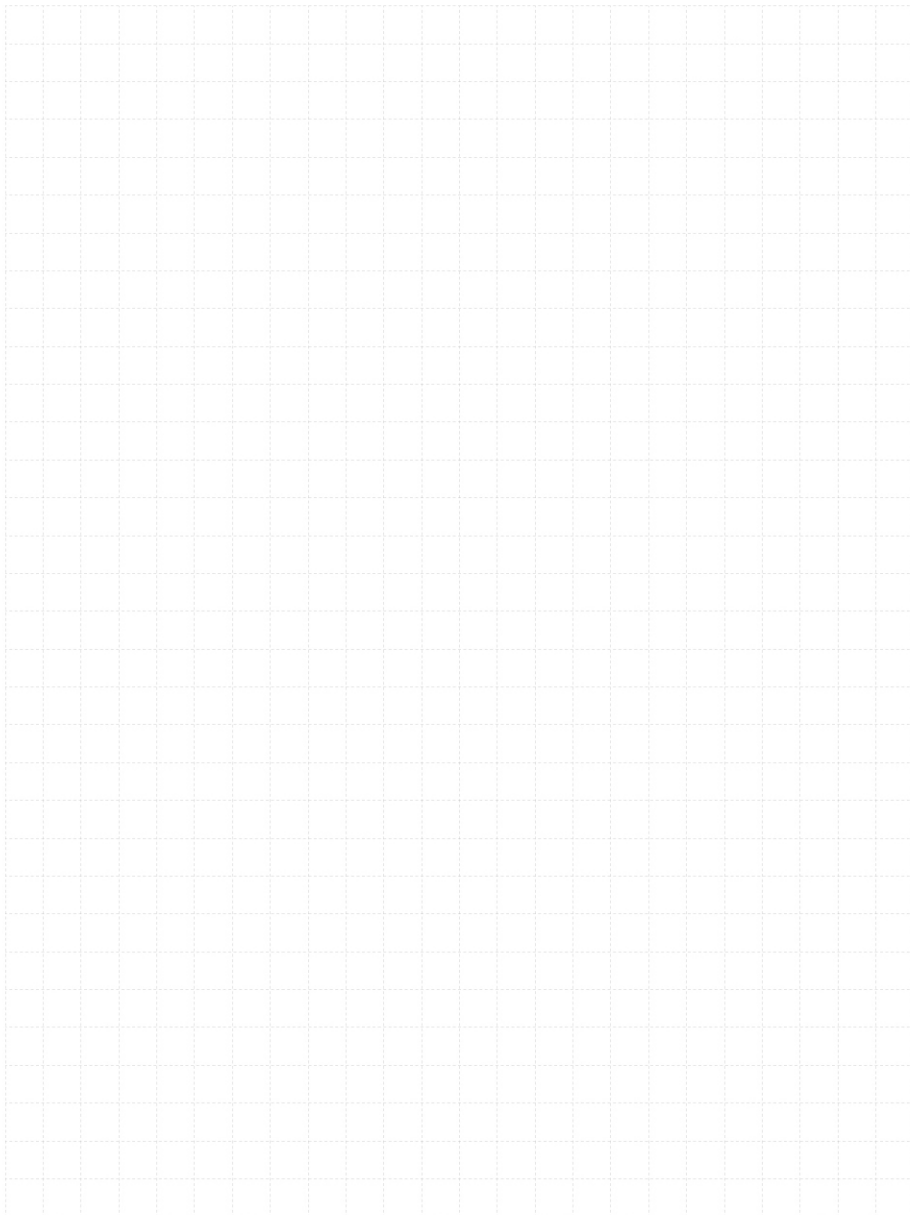

### 3.1.4 HSV



# HSV Expansion anchor

## Economical expansion anchor for uncracked concrete

Anchor version	Benefits
 <p>HSV (F) (M8-M16)</p>	<ul style="list-style-type: none"> <li>- Torque-controlled mechanical expansion allows immediate load application</li> <li>- Setting mark</li> <li>- Cold-formed to prevent breaking during installation</li> <li>- Raised impact section prevents thread damage during installation</li> <li>- Drill bit size is same as anchor size for easy installation.</li> </ul>
 <p>HSV-BW (M8-M16)</p>	

### Base material



Concrete  
(non-cracked)

### Basic loading data (for a single anchor)

#### All data in this section applies to:

- Correct setting (See setting instruction)
- No edge distance and spacing influence
- Concrete as specified in the table
- Steel failure
- Minimum base material thickness
- Concrete C 20/25,  $f_{ck,cube} = 25 \text{ N/mm}^2$

#### Effective anchorage depth for static <sup>a)</sup>

Anchor size			M8		M10		M12		M16	
Effective anchorage depth	$h_{ef}$	[mm]	30	40	40	50	50	65	65	80

a) HSV-F only for sizes M10, M12 and M16

#### Characteristic resistance

Anchor size				M8		M10		M12		M16	
Tension	HSV / HSV-BW	$N_{Rk}$	[kN]	8,3	12,0	12,0	14,0	14,5	20,0	26,5	36,1
	HSV-F			-	-	10,0	14,0	14,5	20,0	26,5	36,1
Shear	HSV / HSV-BW	$V_{Rk}$	[kN]	8,3	8,5	12,8	14,4	17,9	22,6	42,4	42,4
	HSV-F			-	-	12,8	14,4	17,9	22,6	42,4	42,4

#### Design resistance

Anchor size				M8		M10		M12		M16	
Tension	HSV / HSV-BW	$N_{Rd}$	[kN]	4,6	6,7	8,0	9,3	9,7	13,3	14,7	20,1
	HSV-F			-	-	6,7	9,3	9,7	13,3	14,7	20,1
Shear	HSV / HSV-BW	$V_{Rd}$	[kN]	5,5	6,8	8,5	11,5	11,9	18,1	33,9	33,9
	HSV-F			-	-	8,5	11,5	11,9	18,1	33,9	33,9

**Recommended loads <sup>a)</sup>**

Anchor size				M8		M10		M12		M16	
Tension	HSV / HSV-BW	$N_{Rec}$	[kN]	3,3	4,8	5,7	6,7	6,9	9,5	10,5	14,3
	HSV-F			-	-	4,8	6,7	6,9	9,5	10,5	14,3
Shear	HSV / HSV-BW	$V_{Rec}$	[kN]	4,0	4,9	6,1	8,2	8,5	12,9	24,2	24,2
	HSV-F			-	-	6,1	8,2	8,5	12,9	24,2	24,2

a) With overall partial safety factor for action  $\gamma = 1,4$ . The partial safety factors for action depend on the type of loading and shall be taken from national regulations.

**Materials**
**Mechanical properties <sup>a)</sup>**

Anchor size			M8	M10	M12	M16
Nominal tensile strength	$f_{uk}$	[N/mm <sup>2</sup> ]	580	660	660	660
Yield strength	$f_{yk}$	[N/mm <sup>2</sup> ]	464	528	528	528
Stressed cross-section, thread	$A_s$	[mm <sup>2</sup> ]	36,6	58,0	84,3	157
Stressed cross-section, neck	$A_{s, necl}$	[mm <sup>2</sup> ]	26,9	39,6	63,6	105,7
Moment of resistance	$W$	[mm <sup>3</sup> ]	31,2	62,3	109,2	277,5
Char. bending resistance for rod or bolt with 5.8 steel grade	$M^{0}_{Rk,s}$	[Nm]	19,5	41,1	72,1	166,5

a) HSV-F only for sizes M10, M12 and M16.

**Material quality**

Part		Material
Bolt	HSV	Carbon steel, galvanized to min. 5 $\mu$ m
	HSV - BW	Carbon steel, galvanized to min. 5 $\mu$ m with DIN 9021 washer and DIN 127b spring washer
	HSV-F	For M10 to M16 hot dipped galvanized to min. 42 $\mu$ m with DIN 9021 washer and DIN 127b spring washer

**Anchor dimension <sup>a)</sup>**

Anchor size			M8	M10	M12	M16
Shaft diameter at the cone	$d_R$	[mm]	5,85	7,1	9,0	11,6
Maximum length of the anchor	$l_1$	[mm]	75	100	150	140
Length of expansion sleeve	$l_2$	[mm]	15	17,6	20,6	24

a) HSV-F only for sizes M10, M12 and M16.

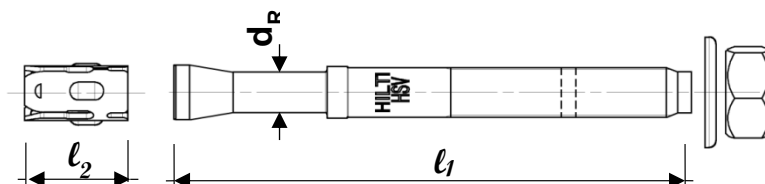

**Setting information**
**Setting details <sup>a)</sup>**

Anchor size		M8		M10		M12		M16	
Effective anchorage depth	$h_{ef}$ [mm]	30	40	40	50	50	65	65	80
Nominal embedment depth	$h_{nom}$ [mm]	39	49	51	61	62	77	81	96
Nominal diameter of drill bit	$d_0$ [mm]	8		10		12		16	
Cutting diameter of drill bit	$d_{cut} \leq$ [mm]	8,45		10,45		12,5		16,5	
Depth of drill hole	$h_1 \geq$ [mm]	45	55	60	70	70	85	90	105
Min. thickness of fixture <sup>b)</sup>	$t_{fix,min}$ [mm]	5	0	5	0	5	0	5	0
Max. thickness of fixture <sup>b)</sup>	HSV(-BW) $t_{fix,max}$ [mm] HSV-F	20	10	35	25	70	55	35	20
		-	-	55	45	60	45	35	20
Diameter of clearance hole in the fixture	$d_f \leq$ [mm]	9		12		14		18	
Torque moment	$T_{inst}$ [Nm]	15		30		50		100	
Width across nut flats	SW [mm]	13		17		19		24	

a) HSV-F only for sizes M10, M12 and M16.

b) The values are only valid for HSV with standard washer. For HSV-BW with DIN 9021 washer and DIN 127b spring washer the thickness of the fixture has to be reduced.

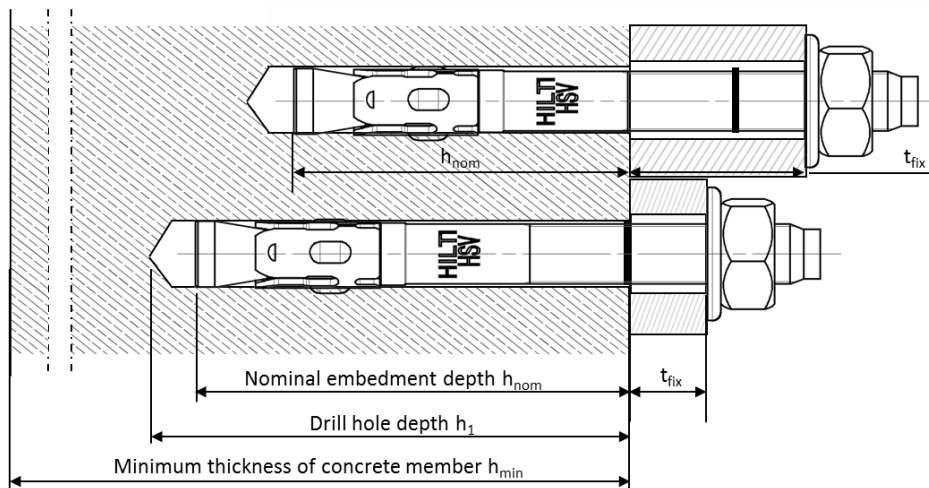
**Installation equipment <sup>a)</sup>**

Anchor size	M8	M10	M12	M16
Rotary hammer	TE 1 – TE 30			
Other tools	Blow out pump, hammer, torque wrench			

a) HSV-F only for sizes M10, M12 and M16.

**Setting parameters <sup>a)</sup>**

Anchor size				M8		M10		M12		M16	
Effective anchorage depth	HSV (-BW)	$h_{ef}$	[mm]	30	40	40	50	50	65	65	80
	HSV-F			-	-	40	50	50	65	65	80
Minimum base material thickness	HSV (-BW)	$h_{min} \geq$	[mm]	100	100	100	120	140	140	130	170
	HSV-F			-	-	120	120	140	140	170	170
Minimum spacing	HSV (-BW)	$s_{min} \geq$	[mm]	60	60	70	70	80	80	120	100
	HSV-F			-	-	105	105	120	120	190	190
Minimum edge distance	HSV (-BW)	$c_{min} \geq$	[mm]	60	60	70	70	90	90	120	100
	HSV-F			-	-	105	105	140	140	140	140
Critical spacing for splitting failure <sup>b)</sup>	HSV (-BW)	$s_{cr,sp}$	[mm]	180	240	240	300	300	390	390	480
	HSV-F			-	-	240	300	300	390	390	480
Critical edge distance for splitting failure <sup>b)</sup>	HSV (-BW)	$c_{cr,sp}$	[mm]	90	120	120	150	150	195	195	240
	HSV-F			-	-	120	150	150	195	195	240
Critical spacing for concrete cone failure <sup>b)</sup>	HSV (-BW)	$s_{cr,N}$	[mm]	90	120	120	150	150	195	195	240
	HSV-F			-	-	120	150	150	195	195	240
Critical edge distance for concrete cone failure <sup>b)</sup>	HSV (-BW)	$c_{cr,N}$	[mm]	45	60	60	75	75	97,5	97,5	120
	HSV-F			-	-	60	75	75	97,5	97,5	120

a) HSV-F only for sizes M10, M12 and M16.

b) In a case of smaller edge distance and spacing than  $c_{cr,sp}$ ,  $s_{cr,sp}$ , and  $s_{cr,N}$  the load values shall be reduced according ETAG 001, Annex C.

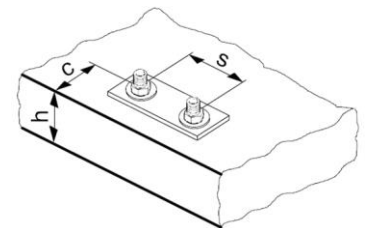
**Setting instruction**

\*For detailed information on installation see instruction for use given with the package of the product.

Setting instruction for HSV (-BW)	
<b>1. Drilling</b> 	<b>2. Cleaning</b> 
<b>3. Inserting the anchor</b> 	<b>4. Checking</b> 
<b>5. Checking</b> 	<b>6. Applying setting tool</b> 

### 3.1.5 HSB

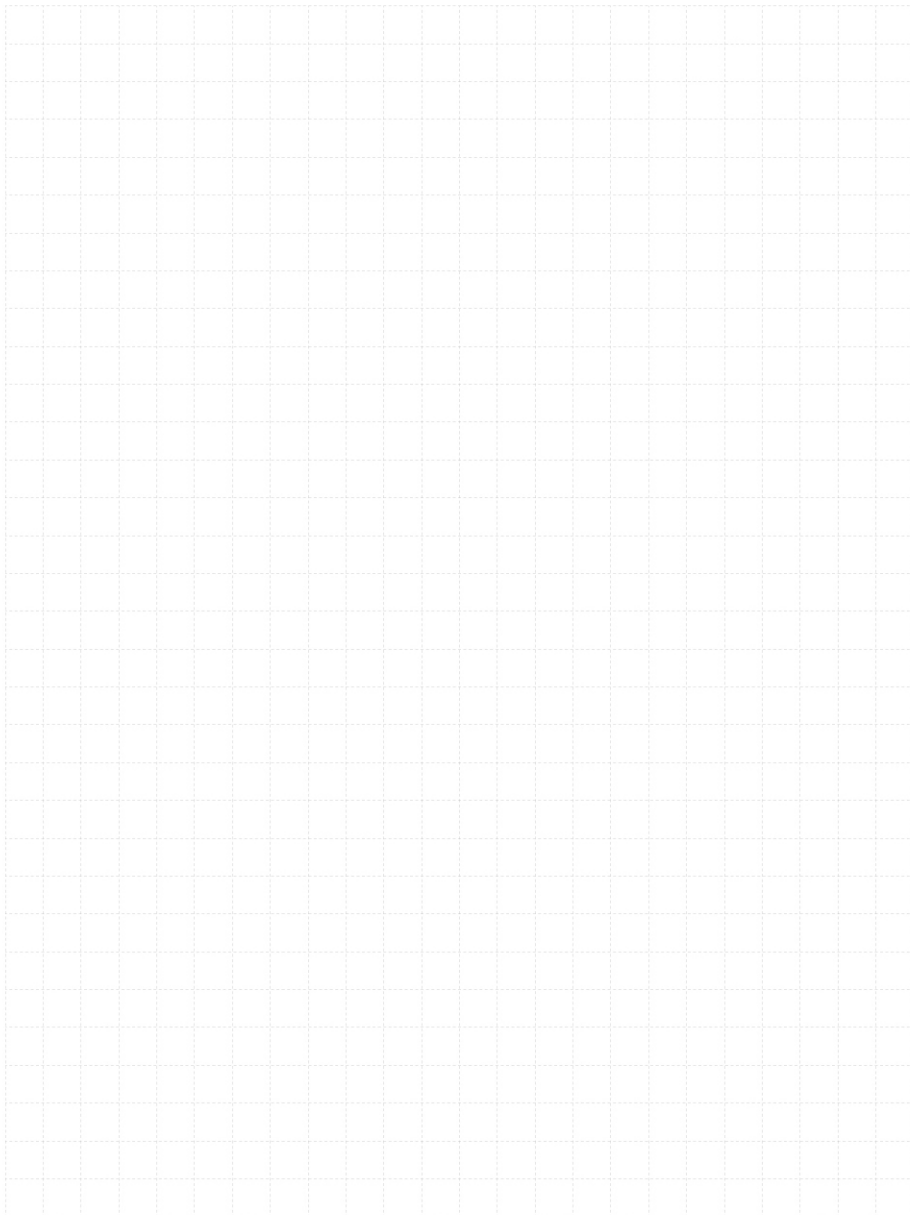
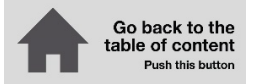

# HSB Expansion anchor

Everyday economical expansion anchor for uncracked concrete

## Anchor version



HSB  
(M8-M16)

## Benefits

- Torque-controlled mechanical expansion allows immediate load application
- Drill bit size is same as anchor size for easy installation
- Suitable for pre- and through-fastening
- ETA approved

## Base material



Concrete  
(non-cracked)

## Load conditions

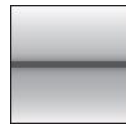

Static/  
quasi-static

## Installation conditions

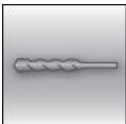

Hammer  
drilled holes

## Other information



European  
Technical  
Assessment



CE  
conformity

## Approvals / certificates

Description	Authority / Laboratory	No. / date of issue
European technical assessment <sup>a)</sup>	DIBt, Berlin	ETA-17/0452 / 2017-07-27

a) All data given in this section according to ETA-17/0452, issue 2017-07-27.

## Basic loading data (for a single anchor)

### All data in this section applies to:

- Correct setting (See setting instruction)
- No edge distance and spacing influence
- Concrete as specified in the table
- Steel failure
- Minimum base material thickness
- Concrete C 20/25,  $f_{ck,cube} = 25 \text{ N/mm}^2$

### Effective anchorage depth

Anchor size		M8	M10	M12	M16
Effective anchorage depth	$h_{ef}$ [mm]	30	40	50	65

### Characteristic resistance

Anchor size		M8	M10	M12	M16
Tension	$N_{Rk}$ [kN]	8,1	12,0	14,6	25,8
Shear	$V_{Rk}$ [kN]	8,1	12,4	17,4	42,4

### Design resistance

Anchor size		M8	M10	M12	M16
Tension	$N_{Rd}$ [kN]	4,5	8,0	9,7	14,3
Shear	$V_{Rd}$ [kN]	5,4	8,3	11,6	33,9

### Recommended loads <sup>a)</sup>

Anchor size		M8	M10	M12	M16
Tension	$N_{Rec}$ [kN]	3,2	5,7	7,0	10,2
Shear	$V_{Rec}$ [kN]	3,8	5,9	8,3	24,2

a) With overall partial safety factor for action  $\gamma = 1,4$ . The partial safety factors for action depend on the type of loading and shall be taken from national regulations.

## Materials

### Mechanical properties

Anchor size		M8	M10	M12	M16
Nominal tensile strength	$f_{uk}$ [N/mm <sup>2</sup> ]	580	660	660	660
Yield strength	$f_{yk}$ [N/mm <sup>2</sup> ]	464	528	528	528
Stressed cross-section, thread	$A_s$ [mm <sup>2</sup> ]	36,6	58,0	84,3	157
Stressed cross-section, neck	$A_{s, neck}$ [mm <sup>2</sup> ]	26,9	39,6	63,6	105,7
Moment of resistance	$W$ [mm <sup>3</sup> ]	31,2	62,3	109,2	277,5
Characteristic bending resistance	$M^0_{Rk,s}$ [Nm]	19,5	41,1	72,1	166,5

### Material quality

Part	Material
Expansion sleeve	Carbon steel, galvanized
Bolt	Carbon steel, galvanized, rupture elongation ( $l_0=5d$ )>8%
Washer	Carbon steel, galvanized
Hexagon nut	Carbon steel, galvanized



**Anchor dimension**

Anchor size		M8	M10	M12	M16
Min. inner diameter of washer	$d_1$ [mm]	8,4	10,5	13	17
Min. outer diameter of washer	$d_w$ [mm]	16	20	24	30
Min. thickness of washer	$h$ [mm]	1,6	2	2,5	3

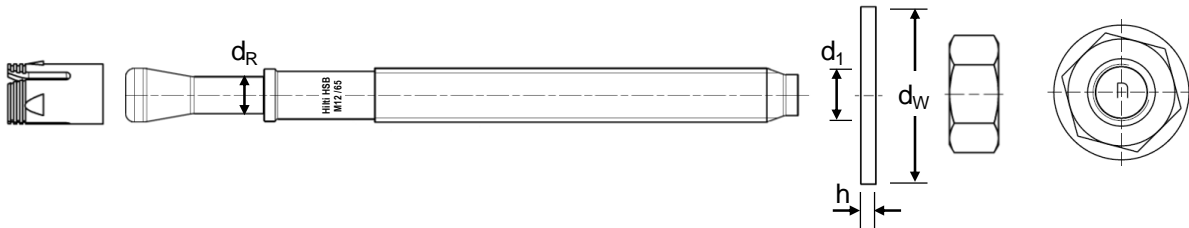
**Letter code for identification of fixture thickness**

Anchor size		M8	M10	M12	M16
Letter	$t_{fix}$	[mm]	[mm]	[mm]	[mm]
z		5	5	5	5
w		20	20	20	20
t		35	35	35	-
s		-	-	-	40
q		-	50	-	-
p		55	-	-	-
n		-	-	65	-
m		-	70	-	-
j		-	-	-	85
h		-	-	95	-

**Setting information**
**Setting details**

Anchor size		M8	M10	M12	M16
Effective anchorage depth	$h_{ef}$ [mm]	30	40	50	65
Nominal anchorage depth	$h_{nom}$ [mm]	39	50	64	77
Nominal diameter of drill bit	$d_0$ [mm]	8	10	12	16
Cutting diameter of drill bit	$d_{cut} \leq$ [mm]	8,45	10,45	12,5	16,5
Depth of drill hole	$h_1 \geq$ [mm]	44	55	72	85
Diameter of clearance hole in the fixture	$d_f \leq$ [mm]	9	12	14	18
Torque moment	$T_{inst}$ [Nm]	15	30	50	80
Width across flats	SW [mm]	13	17	19	24

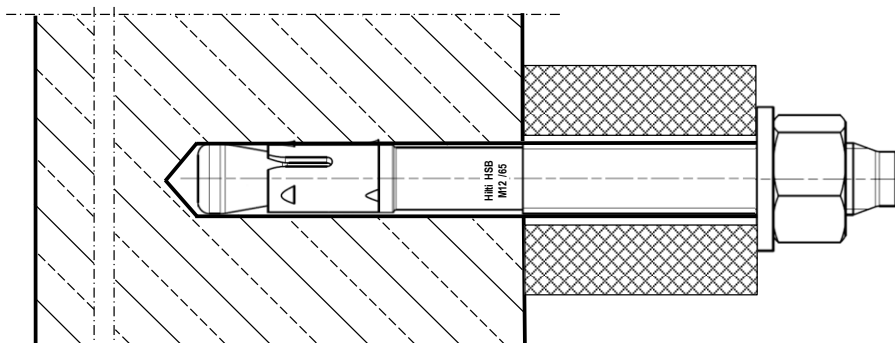

**Installation equipment**

Anchor size	M8	M10	M12	M16
Rotary hammer	TE 2 – TE 16			
Other tools	Blow out pump, hammer, torque wrench			

**Setting parameters**

Anchor size		M8	M10	M12	M16
Min. thickness of concrete member	$h_{min}$ [mm]	100	100	100	140
Min. spacing	$s_{min} \geq$ [mm]	60	70	80	100
Min. edge distance	$c_{min} \geq$ [mm]	60	70	90	100

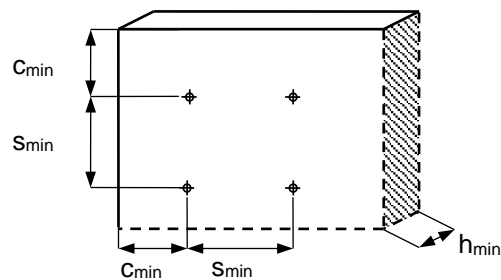
**Setting instruction**

\*For detailed information on installation see instruction for use given with the package of the product.

Setting instruction for HSB	
<b>1. Hammer drilling</b> 	<b>2. Manual cleaning</b> 
<b>3. Insert the anchor</b> 	<b>4. Check setting</b> 
<b>5. Torque wrench</b> 	<b>6. Check installation</b> 

### 3.1.6 HSL-4

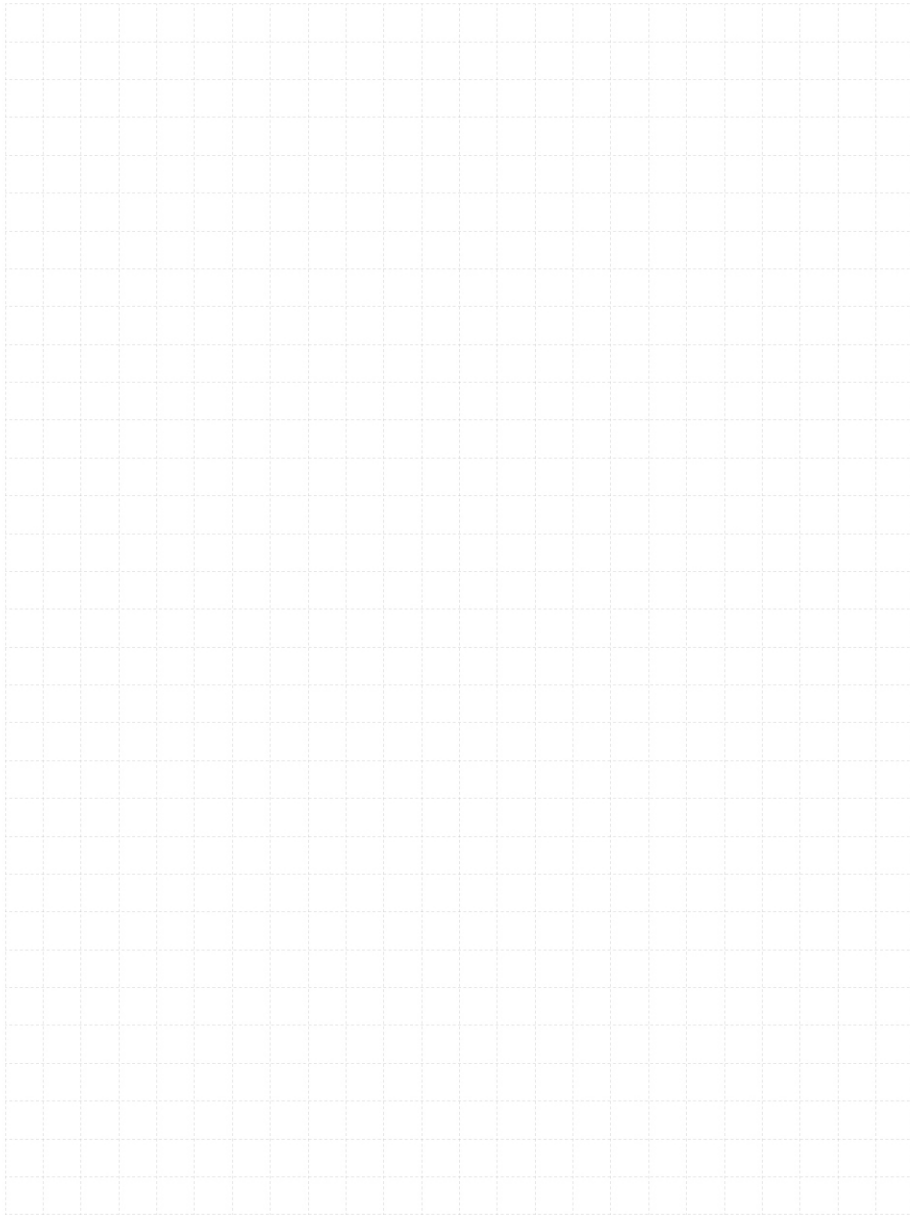

<http://hilti.to/traceable-fastener>

# HSL4 expansion anchor

## Ultimate-performance heavy-duty expansion anchor

Anchor versions		Benefits
		HSL4 Bolt version (M8-M24)
		HSL4-G Threaded rod version (M8-M24)
		HSL4-B Safety cap version (M12-M24)
		HSL4-SK Countersunk version (M8-M12)

- Suitable for cracked concrete C20/25 to C50/60
- Suitable for seismic C1 and C2, shock, fire and fatigue
- Installation with hammer drilling, diamond drilling and hollow drill bit available for same performance
- Top shear performance due to high strength expansion and shear sleeves
- HSL4-B special safety cap ensures proper installation torque even without calibrated torque wrench
- Tracefast improves quality assurance of anchor installation by making every fastener uniquely identifiable and allowing easy documentation
- Easily removable for temporary and machine fastening applications or retrofit needs

### Base material

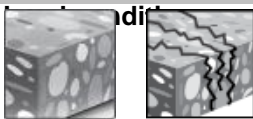

Concrete (uncracked)    Concrete (cracked)

### Load conditions

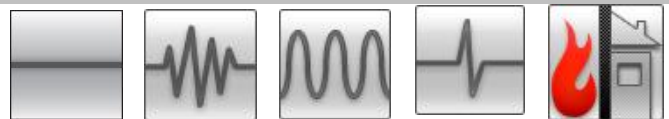

Static/quasi-static    Seismic ETA-C1, C2    Fatigue ETA    Shock    Fire resistance ETA

### Installation conditions

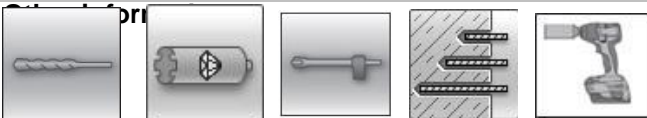

Hammer drilled holes    Diamond cored holes    Hollow drill bit drilling    Variable embedment depth    Impact wrench with adaptive torque module

### Other information



Tracefast    European Technical Assessment    CE conformity    Nuclear power plant approval    PROFIS Engineering design Software



<http://hilti.to/traceable-fastener>

### Approvals/certificates

Description	Authority / Laboratory	No. / Date of issue
European technical Assessment <sup>a)</sup>	CSTB, Marne-la-Vallée	ETA-19/0556 / 2022-11-02
Fire test report	CSTB, Marne-la-Vallée	ETA-19/0556 / 2022-11-02
European technical Assessment <sup>b)</sup>	CSTB, Marne-la-Vallée	ETA-19/0858 / 2022-11-02
ICC-ES report incl. seismic <sup>c)</sup>	ICC evaluation service	ESR 4386 / 2020-03
Shock approval	Civil Protection of Switzerland	BZS D 19-601
ACI 349-01 nuclear suitability	Hilti, Inc. Plano, Texas	2021-01-19

a) All data for static or seismic load cases given in this section according to ETA-19/0556, issued 2022-11-02.

b) All data for fatigue relevant load cases given in this section according to ETA-19/0858, issued 2022-11-02.

c) For more details on Technical Data according to ICC please consult the relevant HNA FTM.

### Static and quasi-static resistance (for a single anchor)

#### All data in this section applies to:

- Correct setting (See setting instruction)
- No edge distance and spacing influence
- Steel failure
- Minimum base material thickness
- Concrete C 20/25,  $f_c = 20 \text{ N/mm}^2$

#### Effective anchorage depth <sup>a)</sup>

Anchor size	M8			M10			M12		
	$h_{ef,1}^{b)}$	$h_{ef,2}$	$h_{ef,3}$	$h_{ef,1}^{b)}$	$h_{ef,2}$	$h_{ef,3}$	$h_{ef,1}^{b)}$	$h_{ef,2}$	$h_{ef,3}$
Effective anchorage depth $h_{ef}$ [mm]	60	80	100	70	90	110	80	105	130
Anchor size	M16			M20			M24		
	$h_{ef,1}$	$h_{ef,2}$	$h_{ef,3}$	$h_{ef,1}$	$h_{ef,2}$	$h_{ef,3}$	$h_{ef,1}$	$h_{ef,2}$	$h_{ef,3}$
Effective anchorage depth $h_{ef}$ [mm]	100	125	150	125	155	185	150	180	210

a) HSL4-SK only available in sizes M8-M12, HSL4-B only available in sizes M12-M24

b) HSL4-SK can only be set in position 1.

<http://hilti.to/traceable-fastener>
**Characteristic resistance**

Anchor size				M8			M10			M12		
<b>Non-cracked concrete</b>												
Tension	HSL4 / HSL4-B HSL4-G HSL4-SK <sup>a)</sup>	N <sub>Rk</sub>	[kN]	22,9	29,3	29,3	28,8	42,0	46,4	35,2	52,9	67,4
Shear	HSL4 / HSL4-B HSL4-G	V <sub>Rk</sub>	[kN]	31,1	31,1	31,1	60,5	60,5	60,5	89,6	89,6	89,6
				26,1	26,1	26,1	41,8	41,8	41,8	59,3	59,3	59,3
	HSL4-SK <sup>a)</sup>	t <sub>fix</sub>	[mm]	≥11	-	-	≥11	-	-	≥13	-	-
		V <sub>Rk</sub>	[kN]	31,1	-	-	60,5	-	-	89,6	-	-
		t <sub>fix</sub>	[mm]	<11	-	-	<11	-	-	<13	-	-
V <sub>Rk</sub>	[kN]	14,6	-	-	23,2	-	-	33,7	-	-		
<b>Cracked concrete</b>												
Tension	HSL4 / HSL4-B HSL4-G HSL4-SK <sup>a)</sup>	N <sub>Rk</sub>	[kN]	12,0	12,0	12,0	16,0	16,0	16,0	24,6	24,0	24,0
Shear	HSL4 / HSL4-B HSL4-G	V <sub>Rk</sub>	[kN]	31,1	31,1	31,1	52,4	60,5	60,5	66,5	89,6	89,6
				26,1	26,1	26,1	41,8	41,8	41,8	59,3	59,3	59,3
	HSL4-SK <sup>a)</sup>	t <sub>fix</sub>	[mm]	≥11	-	-	≥11	-	-	≥13	-	-
		V <sub>Rk</sub>	[kN]	31,1	-	-	52,4	-	-	66,5	-	-
		t <sub>fix</sub>	[mm]	<11	-	-	<11	-	-	<13	-	-
V <sub>Rk</sub>	[kN]	14,6	-	-	23,2	-	-	33,7	-	-		
<b>Anchor size</b>				<b>M16</b>			<b>M20</b>			<b>M24</b>		
<b>Non-cracked concrete</b>												
Tension	HSL4 / HSL4-B HSL4-G	N <sub>Rk</sub>	[kN]	49,2	65,0	65,0	68,8	94,9	95,0	90,4	100	100
Shear	HSL4 / HSL4-B HSL4-G	V <sub>Rk</sub>	[kN]	137,7	158,5	158,5	186,0	186,0	186,0	204,5	204,5	204,5
				120,6	120,6	120,6	155,3	155,3	155,3	204,5	204,5	204,5
<b>Cracked concrete</b>												
Tension	HSL4 / HSL4-B HSL4-G	N <sub>Rk</sub>	[kN]	34,4	36,0	36,0	48,1	50,0	50,0	63,3	65,0	65,0
Shear	HSL4 / HSL4-B HSL4-G	V <sub>Rk</sub>	[kN]	96,4	135	158,5	182,9	186,0	186,0	202,4	204,5	204,5
				96,4	120,6	120,6	155,3	155,3	155,3	202,4	204,5	204,5

a) HSL4-SK can only be set in position 1.

<http://hilti.to/traceable-fastener>
**Design resistance**

Anchor size			M8			M10			M12		
<b>Non-cracked concrete</b>											
Tension	HSL4 / HSL4-B HSL4-G HSL4-SK <sup>a)</sup>	N <sub>Rd</sub> [kN]	15,2	19,5	19,5	19,2	28,0	30,9	23,5	35,3	45,0
Shear	HSL4 / HSL4-B HSL4-G	V <sub>Rd</sub> [kN]	24,9	24,9	24,9	48,4	48,4	48,4	63,4	71,7	71,7
		t <sub>fix</sub> [mm]	≥11	-	-	≥11	-	-	≥13	-	-
	HSL4-SK <sup>a)</sup>	V <sub>Rd</sub> [kN]	24,9	-	-	48,4	-	-	63,4	-	-
		t <sub>fix</sub> [mm]	<11	-	-	<11	-	-	<13	-	-
		V <sub>Rd</sub> [kN]	11,7	-	-	18,6	-	-	27,0	-	-
<b>Cracked concrete</b>											
Tension	HSL4 / HSL4-B HSL4-G HSL4-SK <sup>a)</sup>	N <sub>Rd</sub> [kN]	8,0	8,0	8,0	10,7	10,7	10,7	16,4	16,0	16,0
Shear	HSL4 / HSL4-B HSL4-G	V <sub>Rd</sub> [kN]	20,1	24,9	24,9	35,0	48,4	48,4	44,4	66,7	71,7
		t <sub>fix</sub> [mm]	≥11	-	-	≥11	-	-	≥13	-	-
	HSL4-SK <sup>a)</sup>	V <sub>Rd</sub> [kN]	20,1	-	-	35,0	-	-	44,4	-	-
		t <sub>fix</sub> [mm]	<11	-	-	<11	-	-	<13	-	-
		V <sub>Rd</sub> [kN]	11,7	-	-	18,6	-	-	27,0	-	-
<b>Anchor size</b>			<b>M16</b>			<b>M20</b>			<b>M24</b>		
<b>Non-cracked concrete</b>											
Tension	HSL4 / HSL4-B HSL4-G	N <sub>Rd</sub> [kN]	32,8	43,3	43,3	45,8	63,3	63,3	60,2	66,7	66,7
Shear	HSL4 / HSL4-B HSL4-G	V <sub>Rd</sub> [kN]	91,8	126,8	126,8	148,8	148,8	148,8	163,6	163,6	163,6
		t <sub>fix</sub> [mm]	91,8	96,5	96,5	124,2	124,2	124,2	163,6	163,6	163,6
<b>Cracked concrete</b>											
Tension	HSL4 / HSL4-B HSL4-G	N <sub>Rd</sub> [kN]	23,0	24,0	24,0	32,1	33,3	33,3	42,2	43,3	43,3
Shear	HSL4 / HSL4-B HSL4-G	V <sub>Rd</sub> [kN]	64,3	89,8	118,1	121,9	148,8	148,8	135,0	163,6	163,6
		t <sub>fix</sub> [mm]	64,3	89,8	96,5	121,9	124,2	124,2	135,0	163,6	163,6

a) HSL4-SK can only be set in position 1

<http://hilti.to/traceable-fastener>
**Recommended loads <sup>b)</sup>**

Anchor size			M8			M10			M12		
<b>Non-cracked concrete</b>											
Tension	HSL4 / HSL4-B HSL4-G HSL4-SK <sup>a)</sup>	N <sub>Rec</sub> [kN]	10,9	13,9	13,9	13,7	20,0	22,1	16,8	25,2	32,1
	Shear	HSL4 / HSL4-B HSL4-G	V <sub>Rec</sub> [kN]	17,8	17,8	17,8	34,6	34,6	34,6	45,3	51,2
HSL4-SK <sup>a)</sup>		t <sub>fix</sub> [mm]	≥11	-	-	≥11	-	-	≥13	-	-
		V <sub>Rec</sub> [kN]	17,8	-	-	34,6	-	-	45,3	-	-
		t <sub>fix</sub> [mm]	<11	-	-	<11	-	-	<13	-	-
		V <sub>Rec</sub> [kN]	8,3	-	-	13,3	-	-	19,3	-	-
<b>Cracked concrete</b>											
Tension	HSL4 / HSL4-B HSL4-G HSL4-SK <sup>a)</sup>	N <sub>Rec</sub> [kN]	5,7	5,7	5,7	7,6	7,6	7,6	11,7	11,4	11,4
	Shear	HSL4 / HSL4-B HSL4-G	V <sub>Rec</sub> [kN]	17,8	17,8	17,8	25,0	34,6	34,6	31,7	47,6
HSL4-SK <sup>a)</sup>		t <sub>fix</sub> [mm]	≥11	-	-	≥11	-	-	≥13	-	-
		V <sub>Rec</sub> [kN]	17,8	-	-	25,0	-	-	31,7	-	-
		t <sub>fix</sub> [mm]	<11	-	-	<11	-	-	<13	-	-
		V <sub>Rec</sub> [kN]	8,3	-	-	13,3	-	-	19,3	-	-
Anchor size			M16			M20			M24		
<b>Non-cracked concrete</b>											
Tension	HSL4 / HSL4-B HSL4-G	N <sub>Rec</sub> [kN]	23,4	31,0	31,0	32,7	45,2	45,2	43,0	47,6	47,6
	Shear	HSL4 / HSL4-B	V <sub>Rec</sub> [kN]	65,6	90,6	90,6	106,3	106,3	106,3	116,9	116,9
HSL4-G		65,6		68,9	68,9	88,7	88,7	88,7	116,9	116,9	116,9
<b>Cracked concrete</b>											
Tension	HSL4 / HSL4-B HSL4-G	N <sub>Rec</sub> [kN]	16,4	17,1	17,1	22,9	23,8	23,8	30,1	31,0	31,0
	Shear	HSL4 / HSL4-B	V <sub>Rec</sub> [kN]	45,9	64,2	84,3	87,1	106,3	106,3	96,4	116,9
HSL4-G		45,9		64,2	68,9	87,1	88,7	88,7	96,4	116,9	116,9

a) HSL4-SK only available in sizes M8-M12, HSL4-B only available in sizes M12-M24

b) With overall partial safety factor for action  $\gamma = 1,4$ . The partial safety factors for action depend on the type of loading and shall be taken from national regulations.



<http://hilti.to/traceable-fastener>

### Seismic resistance (for a single anchor)

#### All data in this section applies to:

- Correct setting (See setting instruction)
- No edge distance and spacing influence
- Steel failure
- Minimum base material thickness
- Concrete C 20/25,  $f_c = 20 \text{ N/mm}^2$
- $\alpha_{\text{gap}} = 0,5$

#### Effective anchorage depth for seismic C2<sup>a)</sup>

Anchor size		M10			M12					
Effective anchorage depth	$h_{\text{ef}}$ [mm]	$h_{\text{ef},1}^{\text{b)}$	$h_{\text{ef},2}$	$h_{\text{ef},3}$	$h_{\text{ef},1}^{\text{b)}$	$h_{\text{ef},2}$	$h_{\text{ef},3}$			
		70	90	110	80	105	130			
Anchor size		M16			M20			M24		
Effective anchorage depth	$h_{\text{ef}}$ [mm]	$h_{\text{ef},1}$	$h_{\text{ef},2}$	$h_{\text{ef},3}$	$h_{\text{ef},1}$	$h_{\text{ef},2}$	$h_{\text{ef},3}$	$h_{\text{ef},1}$	$h_{\text{ef},2}$	$h_{\text{ef},3}$
		100	125	150	125	155	185	150	180	210

a) HSL4-SK only available in sizes M8-M12, HSL4-B only available in sizes M12-M24

b) HSL4-SK can only be set in position 1.

#### Characteristic resistance in case of seismic category C2

Anchor size		M10			M12						
Tension	HSL4 / HSL4-B HSL4-G	$N_{\text{Rk,seis}}$ [kN]	12,2	12,2	12,2	20,9	25,8	25,8			
	HSL4-SK		12,2	-	-	20,9	-	-			
Shear	HSL4 / HSL4-B HSL4-G	$V_{\text{Rk,seis}}$ [kN]	12,7	12,7	12,7	15,3	15,3	15,3			
	HSL4-G		11,3	11,3	11,3	11,3	11,3	11,3			
	HSL4-SK	$t_{\text{fix}}$ [mm]	$\geq 11$	-	-	$\geq 13$	-	-			
		$V_{\text{Rk,seis}}$ [kN]	12,7	-	-	15,3	-	-			
Anchor size		M16			M20			M24			
Tension	HSL4 / HSL4-B HSL4-G	$N_{\text{Rk,seis}}$ [kN]	29,3	34,2	34,2	40,1	40,1	40,1	45,9	45,9	45,9
	HSL4 / HSL4-B HSL4-G		$V_{\text{Rk,seis}}$ [kN]	30,9	30,9	30,9	39,1	39,1	39,1	44,0	44,0
Shear	HSL4-G	22,3		22,3	22,3	25,1	25,1	25,1	38,9	38,9	38,9

#### Design resistance in case of seismic category C2

Anchor size		M10			M12						
Tension	HSL4 / HSL4-B HSL4-G	$N_{\text{Rd,seis}}$ [kN]	8,1	8,1	8,1	14,0	17,2	17,2			
	HSL4-SK		8,1	-	-	14,0	-	-			
Shear	HSL4 / HSL4-B HSL4-G	$V_{\text{Rd,seis}}$ [kN]	10,2	10,2	10,2	12,2	12,2	12,2			
	HSL4-G		9,0	9,0	9,0	9,0	9,0	9,0			
	HSL4-SK	$t_{\text{fix}}$ [mm]	$\geq 11$	-	-	$\geq 13$	-	-			
		$V_{\text{Rd,seis}}$ [kN]	10,2	-	-	12,2	-	-			
Anchor size		M16			M20			M24			
Tension	HSL4 / HSL4-B HSL4-G	$N_{\text{Rd,seis}}$ [kN]	19,5	22,8	22,8	26,7	26,7	26,7	30,6	30,6	30,6
	HSL4 / HSL4-B HSL4-G		$V_{\text{Rd,seis}}$ [kN]	24,7	24,7	24,7	31,2	31,2	31,2	35,2	35,2
Shear	HSL4-G	17,8		17,8	17,8	20,1	20,1	20,1	31,1	31,1	31,1

<http://hilti.to/traceable-fastener>
**Effective anchorage depth for seismic C1 <sup>a)</sup>**

Anchor size			M8			M10			M12		
Effective anchorage depth	$h_{ef}$	[mm]	$h_{ef,1}^{b)}$	$h_{ef,2}$	$h_{ef,3}$	$h_{ef,1}^{b)}$	$h_{ef,2}$	$h_{ef,3}$	$h_{ef,1}^{b)}$	$h_{ef,2}$	$h_{ef,3}$
			60	80	100	70	90	110	80	105	130
Anchor size			M16			M20			M24		
Effective anchorage depth	$h_{ef}$	[mm]	$h_{ef,1}$	$h_{ef,2}$	$h_{ef,3}$	$h_{ef,1}$	$h_{ef,2}$	$h_{ef,3}$	$h_{ef,1}$	$h_{ef,2}$	$h_{ef,3}$
			100	125	150	125	155	185	150	180	210

a) HSL4-SK only available in sizes M8-M12, HSL4-B only available in sizes M12-M24

b) HSL4-SK can only be set in position 1.

**Characteristic resistance in case of seismic category C1**

Anchor size			M8			M10			M12		
Tension	HSL4 / HSL4-B	$N_{Rk,seis}$ [kN]	12,0	12,0	12,0	16,0	16,0	16,0	20,9	24,0	24,0
	HSL4-G		12,0	-	-	16,0	-	-	21,9	-	-
Shear	HSL4 / HSL4-B	$V_{Rk,seis}$ [kN]	8,9	8,9	8,9	22,1	22,1	22,1	28,3	29,1	29,1
	HSL4-G		7,5	7,5	7,5	15,3	15,3	15,3	19,3	19,3	19,3
	HSL4-SK <sup>a)</sup>	$t_{fix}$ [mm]	≥11	-	-	≥11	-	-	≥13	-	-
		$V_{Rk,seis}$ [kN]	8,9	-	-	22,1	-	-	28,3	-	-
Anchor size			M16			M20			M24		
Tension	HSL4 / HSL4-B	$N_{Rk,seis}$ [kN]	29,3	36,0	36,0	40,9	50,0	50,0	53,8	65,0	65,0
	HSL4-G		41,0	57,1	57,1	54,9	54,9	54,9	81,8	81,8	81,8
Shear	HSL4 / HSL4-B	$V_{Rk,seis}$ [kN]	41,0	43,4	43,4	45,8	45,8	45,8	-	-	-
	HSL4-G		41,0	43,4	43,4	45,8	45,8	45,8	-	-	-

**Design resistance in case of seismic category C1**

Anchor size			M8			M10			M12		
Tension	HSL4 / HSL4-B	$N_{Rd,seis}$ [kN]	8,0	8,0	8,0	10,7	10,7	10,7	14,0	16,0	16,0
	HSL4-G		8,0	-	-	10,7	-	-	14,0	-	-
Shear	HSL4 / HSL4-B	$V_{Rd,seis}$ [kN]	7,1	7,1	7,1	14,9	17,7	17,7	18,8	23,3	23,3
	HSL4-G		6,0	6,0	6,0	12,2	12,2	12,2	15,4	15,4	15,4
	HSL4-SK <sup>a)</sup>	$t_{fix}$ [mm]	≥11	-	-	≥11	-	-	≥13	-	-
		$V_{Rk,seis}$ [kN]	7,1	-	-	14,9	-	-	18,8	-	-
Anchor size			M16			M20			M24		
Tension	HSL4 / HSL4-B	$N_{Rd,seis}$ [kN]	19,5	24,0	24,0	27,3	33,3	33,3	35,8	43,3	43,3
	HSL4-G		27,3	38,2	45,6	43,9	43,9	43,9	57,4	65,4	65,4
Shear	HSL4 / HSL4-B	$V_{Rd,seis}$ [kN]	27,3	34,7	34,7	36,6	36,6	36,6	-	-	-
	HSL4-G		27,3	34,7	34,7	36,6	36,6	36,6	-	-	-



<http://hilti.to/traceable-fastener>

## Fatigue resistance

### All data in this section applies to:

- Correct setting using Hilti seismic filling set (See setting instruction)
- No edge distance and spacing influence
- Minimum base material thickness
- Concrete C 20/25,  $f_c = 20 \text{ N/mm}^2$
- Only applicable to HSL4-G version

### Effective anchorage depth

Anchor size			M16			M20		
Effective anchorage depth	$h_{ef}$	[mm]	$h_{ef,1}$	$h_{ef,2}$	$h_{ef,3}$	$h_{ef,1}$	$h_{ef,2}$	$h_{ef,3}$
			100	125	150	125	155	185

### Characteristic resistance

Anchor size			M16			M20			
<b>Non-cracked concrete</b>									
Tension	HSL4-G	$\Delta N_{Rk,0,\infty}$	[mm]	8,3	8,3	8,3	12,0	12,0	12,0
Shear	HSL4-G	$\Delta V_{Rk,0,\infty}$	[mm]	8,0	8,0	8,0	10,0	10,0	10,0
<b>Cracked concrete</b>									
Tension	HSL4-G	$\Delta N_{Rk,0,\infty}$	[mm]	8,3	8,3	8,3	12,0	12,0	12,0
Shear	HSL4-G	$\Delta V_{Rk,0,\infty}$	[mm]	8,0	8,0	8,0	10,0	10,0	10,0

### Design resistance

Anchor size			M16			M20			
<b>Non-cracked concrete</b>									
Tension	HSL4-G	$\Delta N_{Rk,0,\infty}$	[mm]	6,1	6,1	6,1	8,9	8,9	8,9
Shear	HSL4-G	$\Delta V_{Rk,0,\infty}$	[mm]	5,9	5,9	5,9	7,4	7,4	7,4
<b>Cracked concrete</b>									
Tension	HSL4-G	$\Delta N_{Rk,0,\infty}$	[mm]	6,1	6,1	6,1	8,9	8,9	8,9
Shear	HSL4-G	$\Delta V_{Rk,0,\infty}$	[mm]	5,9	5,9	5,9	7,4	7,4	7,4

For more information about different failure modes under fatigue load please see the full ETA-19/0858 report.

<http://hilti.to/traceable-fastener>

## Materials

### Mechanical properties <sup>a)</sup>

Anchor size			M8	M10	M12	M16	M20	M24
<b>HSL4, HSL4-G, HSL4-B, HSL4-SK</b>								
Nominal tensile strength	$f_{uk}$	[N/mm <sup>2</sup> ]	800	800	800	800	800	800
Yield strength	$f_{yk}$	[N/mm <sup>2</sup> ]	640	640	640	640	640	640
Stressed cross-section	$A_s$	[mm <sup>2</sup> ]	36,6	58,0	84,3	157	245	353
Moment of resistance	$W$	[mm <sup>3</sup> ]	31,3	62,5	109	277	541	935
Characteristic bending resistance without sleeve	$M^0_{Rk,s}$	[Nm]	30,0	60,0	105,0	266,0	519,0	898,0

a) HSL4-SK only available in sizes M8-M12, HSL4-B only available in sizes M12-M24

### Material quality

Part		Material
<b>Carbon Steel</b>		
HSL4	Cone	Carbon steel, galvanized to $\geq 5 \mu\text{m}$
HSL4-G	Expansion sleeve	Carbon steel, galvanized to $\geq 5 \mu\text{m}$
HSL4-B	Collapsible element	POM + TPE Plastic element
HSL4-SK	Distance sleeve	Carbon steel, galvanized to $\geq 5 \mu\text{m}$
HSL4	Washer	Carbon steel, galvanized to $\geq 5 \mu\text{m}$
	Hexagonal bolt	Carbon steel, galvanized to $\geq 5 \mu\text{m}$ , rupture elongation $\geq 12\%$
HSL4-G	Hexagonal nut	Carbon steel, galvanized to $\geq 5 \mu\text{m}$
	Threaded rod	Carbon steel, galvanized to $\geq 5 \mu\text{m}$ , rupture elongation $\geq 12\%$
HSL4-B	Hexagonal bolt with safety cap	Carbon steel, galvanized to $\geq 5 \mu\text{m}$ , rupture elongation $\geq 12\%$
HSL4-SK	Countersunk bolt	Carbon steel, galvanized to $\geq 5 \mu\text{m}$ , rupture elongation $\geq 12\%$
	Cup washer	Carbon steel, galvanized to $\geq 5 \mu\text{m}$



<http://hilti.to/traceable-fastener>

### Anchor dimensions of HSL4, HSL4-G, HSL4-B, HSL4-SK

Anchor version	Thread size	$t_{\text{fix}}$ [mm]		$d_s$ [mm]	$l_1$ [mm]	$l_2$ [mm]	$l_3$ [mm]	$l_4$ [mm]		$p$ [mm]
		min	max					min	max	
HSL4	M8	5	200	11,9	12	32	15,2	19	214	2
HSL4-G	M10	5	200	14,8	14	36	17,2	23	218	3
HSL4 HSL4-G HSL4-B	M12	5	200	17,6	17	40	20	28	223	3
	M16	10	200	23,6	20	54,4	24,4	34,5	224,5	4
	M20	10	200	27,6	20	57	31,5	51	241	4
	M24	10	200	31,6	22	65	39	57	247	4
HSL4-SK	M8	6	20	11,9	12	32	15,2	18,2	28,2	2
	M10	6	20	14,8	14	36	17,2	32,2		3
	M12	8	25	17,6	17	40	20	40		3

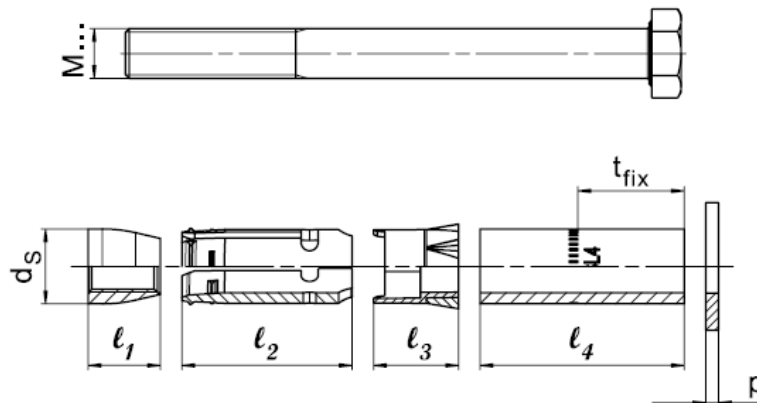



## Setting information

### Setting positions <sup>a)</sup>

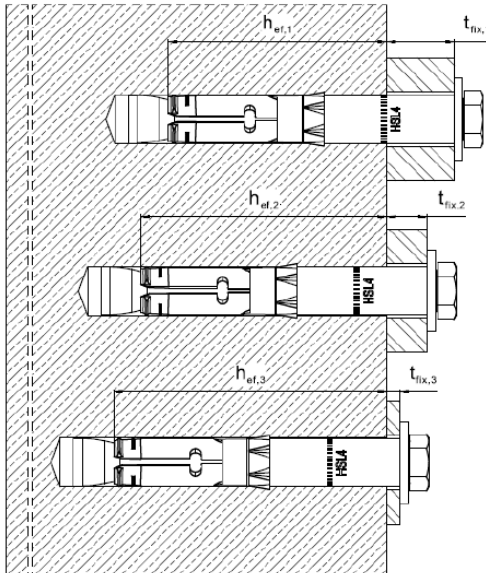

Setting position

①

Setting position

②

Setting position

③

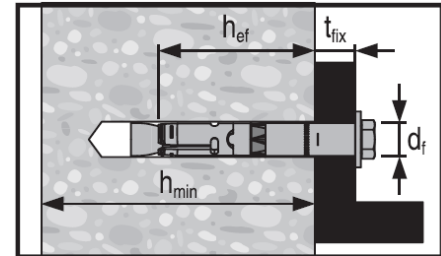

a) HSL4-SK can only be set in position 1.

### Setting details for HSL4

Anchor version		M8			M10			M12		
		①	②	③	①	②	③	①	②	③
Nominal diameter of drill bit	$d_0$ [mm]	12			15			18		
Max. cutting diameter of drill bit	$d_{cut}$ [mm]	12,5			15,5			18,5		
Max. diameter of clearance hole in the fixture	$d_f$ [mm]	14			17			20		
Setting position	$i$	①	②	③	①	②	③	①	②	③
Fixture thickness	$t_{fix,1}$ [mm]	5-200			5-200			5-200		
Effective fixture thickness	$t_{fix,i}$	$t_{fix,1}^{(1)} - \Delta i$								
Reduction of fixture thickness	$\Delta i$ [mm]	0	20	40	0	20	40	0	25	50
Effective anchorage depth	$h_{ef,i}$ [mm]	60	80	100	70	90	110	80	105	130
Min. depth of drill hole	$h_{1,i}$ [mm]	80	100	120	90	110	130	105	130	155
Min. thickness of concrete member	$h_{min,i}$ [mm]	120	170	190	140	195	215	160	225	250
Width across flats	SW [mm]	13			17			19		
Installation torque	$T_{inst}$ [Nm]	15			25			60		
Anchor version		M16			M20			M24		
Nominal diameter of drill bit	$d_0$ [mm]	24			28			32		
Max. cutting diameter of drill bit	$d_{cut}$ [mm]	24,55			28,55			32,7		
Max. diameter of clearance hole in the fixture	$d_f$ [mm]	26			31			35		
Setting position	$i$	①	②	③	①	②	③	①	②	③
Fixture thickness	$t_{fix1}$ [mm]	10-200			10-200			10-200		
Effective fixture thickness	$t_{fix,i}$	$t_{fix,1}^{(1)} - \Delta i$								
Reduction of fixture thickness	$\Delta i$ [mm]	0	25	50	0	30	60	0	30	60
Effective anchorage depth	$h_{ef,i}$ [mm]	100	125	150	125	155	185	150	180	210
Min. depth of drill hole	$h_{1,i}$ [mm]	125	150	175	155	185	215	180	210	240
Min. thickness of concrete member	$h_{min,i}$ [mm]	200	275	300	250	380	410	300	405	435
Width across flats	SW [mm]	24			30			36		
Installation torque	$T_{inst}$ [Nm]	75			145			210		

<http://hilti.to/traceable-fastener>
**Setting details for HSL4-G**

Anchor version					M8			M10			M12		
Nominal diameter of drill bit	$d_0$ [mm]	12			15			18					
Max. cutting diameter of drill bit	$d_{cut}$ [mm]	12,5			15,5			18,5					
Max. diameter of clearance hole in the fixture	$d_f$ [mm]	14			17			20					
Setting position	$i$	①	②	③	①	②	③	①	②	③			
Fixture thickness	$t_{fix,1}$ [mm]	5-200			5-200			5-200					
Effective fixture thickness	$t_{fix,i}$	$t_{fix,1} - \Delta i$											
Reduction of fixture thickness	$\Delta i$ [mm]	0	20	40	0	20	40	0	25	50			
Effective anchorage depth	$h_{ef,i}$ [mm]	60	80	100	70	90	110	80	105	130			
Min. depth of drill hole	$h_{1,i}$ [mm]	80	100	120	90	110	130	105	130	155			
Min. thickness of concrete member	$h_{min,i}$ [mm]	120	170	190	140	195	215	160	225	250			
Width across flats	SW [mm]	13			17			19					
Installation torque	$T_{inst}$ [Nm]	20			27			60					
Anchor version		M16			M20			M24					
Nominal diameter of drill bit	$d_0$ [mm]	24			28			32					
Max. cutting diameter of drill bit	$d_{cut}$ [mm]	24,55			28,55			32,7					
Max. diameter of clearance hole in the fixture	$d_f$ [mm]	26			31			35					
Setting position	$i$	①	②	③	①	②	③	①	②	③			
Fixture thickness	$t_{fix,1}$ [mm]	10-200			10-200			10-200					
Effective fixture thickness	$t_{fix,i}$	$t_{fix,1} - \Delta i$											
Reduction of fixture thickness	$\Delta i$ [mm]	0	25	50	0	30	60	0	30	60			
Effective anchorage depth	$h_{ef,i}$ [mm]	100	125	150	125	155	185	150	180	210			
Min. depth of drill hole	$h_{1,i}$ [mm]	125	150	175	155	185	215	180	210	240			
Min. thickness of concrete member	$h_{min,i}$ [mm]	200	275	300	250	380	410	300	405	435			
Width across flats	SW [mm]	24			30			36					
Installation torque	$T_{inst}$ [Nm]	70			105			180					

**Setting details for HSL4-B**

Anchor version					M12			M16			M20			M24		
Nominal diameter of drill bit	$d_0$ [mm]	18			24			28			32					
Max. cutting diameter of drill bit	$d_{cut}$ [mm]	18,5			24,55			28,55			32,7					
Max. diameter of clearance hole in the fixture	$d_f$ [mm]	20			26			31			35					
Setting position	$i$	①	②	③	①	②	③	①	②	③	①	②	③			
Fixture thickness	$t_{fix,1}$ [mm]	5 - 200			10 - 200			10 - 200			10 - 200					
Effective fixture thickness	$t_{fix,i}$	$t_{fix,1} - \Delta i$														
Reduction of fixture thickness	$\Delta i$ [mm]	0	25	50	0	25	50	0	30	60	0	30	60			
Effective anchorage depth	$h_{ef,i}$ [mm]	80	105	130	100	125	150	125	155	185	150	180	210			
Min. depth of drill hole	$h_{1,i}$ [mm]	105	130	155	125	150	175	155	185	215	180	210	240			
Min. thickness of concrete member	$h_{min,i}$ [mm]	160	225	250	200	275	300	250	380	410	300	405	435			
Width across flats	SW [mm]	24			30			36			41					
Installation torque	$T_{inst}$ [Nm]	The torque moment is controlled by the safety cap														

<http://hilti.to/traceable-fastener>
**Setting details for HSL4-SK <sup>a)</sup>**

Anchor version			M8	M10	M12
Nominal diameter of drill bit	$d_0$	[mm]	12	15	18
Max. cutting diameter of drill bit	$d_{cut}$	[mm]	12,5	15,5	18,5
Max. diameter of clearance hole in the fixture	$d_f$	[mm]	14	17	20
Top diameter of countersunk head in the fixture	$d_h$	[mm]	22,5	25,5	32,9
Bottom diameter of countersunk head in the fixture	$d_h$	[mm]	11,4	14,4	17,4
Height of the countersunk head in the fixture	$h_{cs}$	[mm]	5,8	5,8	8,0
Min. Fixture thickness	$t_{fix,min}^{b)}$	[mm]	6	6	8
Effective anchorage depth	$h_{ef}$	[mm]	60	70	80
Min. depth of drill hole	$h_1$	[mm]	80	90	105
Min. thickness of concrete member	$h_{min}$	[mm]	120	140	160
Width across flats	SW	[mm]	5	6	8
Installation torque	$T_{inst}$	[Nm]	20	32	65

a) HSL4-SK can only be set in position 1.

b) The influence of the thickness of fixture to the characteristic resistance for shear loads, steel failure without lever arm is taken into account

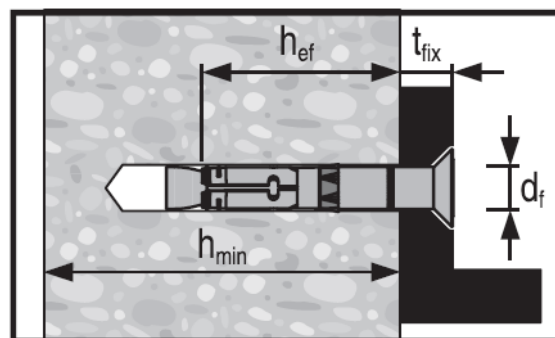
**Installation equipment**

Anchor size	M8	M10	M12	M16	M20	M24
Rotary hammer	TE 2 – TE 30			TE 40 – TE 80		
Diamond coring	DD 30-W or DD-EC-1 + SPX-T DD 110 / 150 + SPX-L handheld		DD 30-W or DD-EC-1 + SPX-T DD 110 / 150 + SPX-L handheld DD 120 / 160 / 150 + SPX-L	DD 30-W or DD-EC-1 + SPX-T DD 110 / 150 + SPX-L handheld DD 120 / 160 / 150 / 200 / 250 + SPX-L		
Other tools	blow out pump, hammer, torque wrench <sup>1)</sup>					

1) HSL4-B only requires a regular wrench as it automatically ensures correct torque is applied.



<http://hilti.to/traceable-fastener>
**Setting parameters for HSL4, HSL4-G, HSL4-B, HSL4-SK <sup>a)</sup>**

Anchor size			M8			M10			M12		
Setting position <sup>b)</sup>	i		①	②	③	①	②	③	①	②	③
Minimum base material thickness	$h_{min}$	[mm]	120	170	190	140	195	215	160	225	250
<b>Uncracked concrete</b>											
Minimum spacing	$s_{min}$	[mm]	60			70			80		
	for $c \geq$	[mm]	100			100			160		
Minimum edge distance	$c_{min}$	[mm]	60			70			80		
	for $s \geq$	[mm]	100			160			240		
<b>Cracked concrete</b>											
Minimum spacing	$s_{min}$	[mm]	50			70			70		
	for $c \geq$	[mm]	80			100			140		
Minimum edge distance	$c_{min}$	[mm]	60			70			70		
	for $s \geq$	[mm]	80			120			160		
Anchor size			M16			M20			M24		
Setting position	i		①	②	③	①	②	③	①	②	③
Minimum base material thickness	$h_{min}$	[mm]	200	275	300	250	380	410	300	405	435
<b>Uncracked concrete</b>											
Minimum spacing	$s_{min}$	[mm]	100			125			150		
	for $c \geq$	[mm]	240			300			300		
Minimum edge distance	$c_{min}$	[mm]	100			150			150		
	for $s \geq$	[mm]	240			300			300		
<b>Cracked concrete</b>											
Minimum spacing	$s_{min}$	[mm]	80			120			120		
	for $c \geq$	[mm]	180			220			260		
Minimum edge distance	$c_{min}$	[mm]	100			120			120		
	for $s \geq$	[mm]	200			220			280		

a) HSL4-SK only available in sizes M8-M12, HSL4-B only available in sizes M12-M24

b) HSL4-SK can only be set in position 1.

<http://hilti.to/traceable-fastener>

## Setting instructions

\*For detailed information on installation of each specific HSL4 version, see instruction for use given with the package of the product.

Setting instruction		
Hole drilling and cleaning		
a) Hammer drilling (HD) with manual cleaning (MC):	b) Diamond coring (DD) with flushing and blowing	c) Hammer drilling (HD) with hollow drill bit (HDB)
Anchor setting		
Hammer setting, check setting		

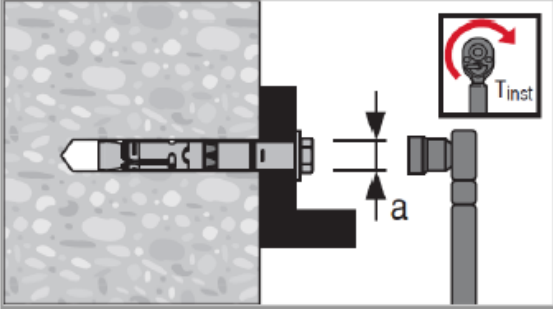
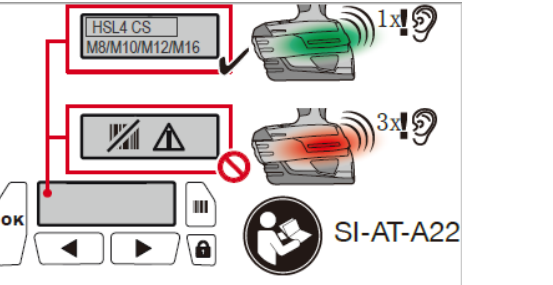
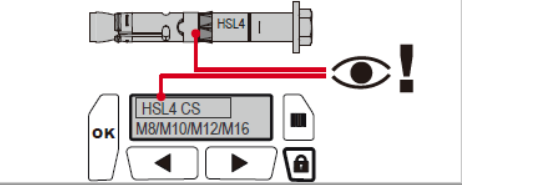
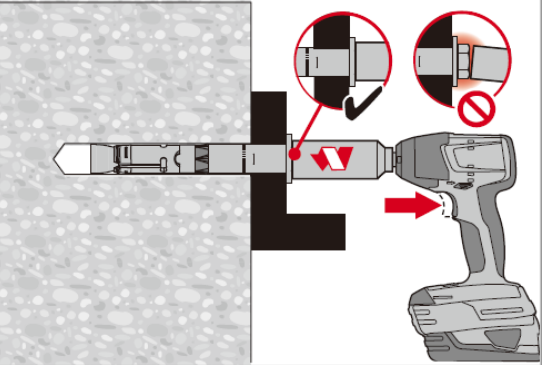
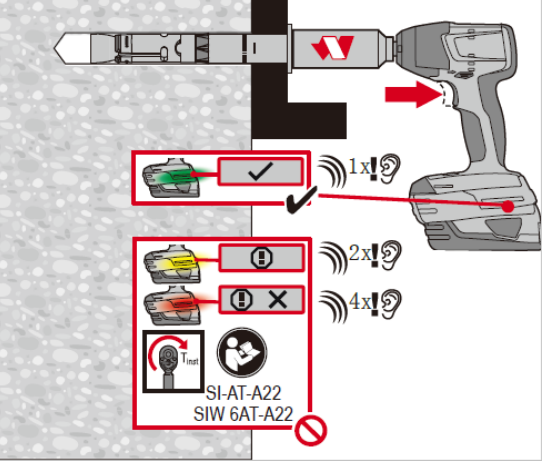
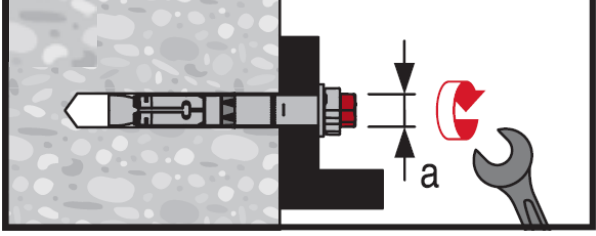
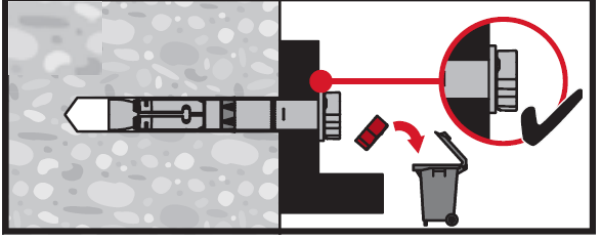

<http://hilti.to/traceable-fastener>

Anchor torquing for HSL4, HSL4-G, SL-4-SK	HSL4-B Safety cap
<p><b>a) Use torque wrench</b></p>  <p><b>b) Machine torquing: Only HSL4 and HSL4-G M8 to M16 a).</b></p>    	 

a) Equivalent combination of Hilti SIW + SI-AT tool, compatible to this anchor type, may be used (e.g. Hilti SIW 4AT-22 with SI-AT-22)



<http://hilti.to/traceable-fastener>

## Setting instructions

\*For detailed information on installation of HSL4-G version, see instruction for use given with the package of the product.

Installation instructions for the filling set															
HSL4-G															
<p>1</p> <p>HSL4-G</p>	<p>1a</p>	<p>2</p>	<p>3</p> <p><math>T_{inst}</math></p>	<p>4</p> <p><math>T_{inst}</math></p> <p>HSL4-G</p>	<p>5</p>	<p>6</p> <p><math>\frac{1}{4} - \frac{1}{2}</math></p> <p><math>t_{fix, effective}</math></p>	<p>7</p> <p>HIT-HY 200-A/-R</p>	<p>8</p> <p>1...3</p>	<p>9</p> <p><math>t_{cure}</math></p> <p>HIT-HY 200-A/-R</p>						
				<table border="1"> <thead> <tr> <th>Size</th> <th><math>t_{fix, effective}</math> (mm)</th> </tr> </thead> <tbody> <tr> <td>M16</td> <td>10 ... 200</td> </tr> <tr> <td>M20</td> <td>10 ... 200</td> </tr> </tbody> </table>		Size	$t_{fix, effective}$ (mm)	M16	10 ... 200	M20	10 ... 200				
Size	$t_{fix, effective}$ (mm)														
M16	10 ... 200														
M20	10 ... 200														

### 3.1.7 HSL-3 (R)

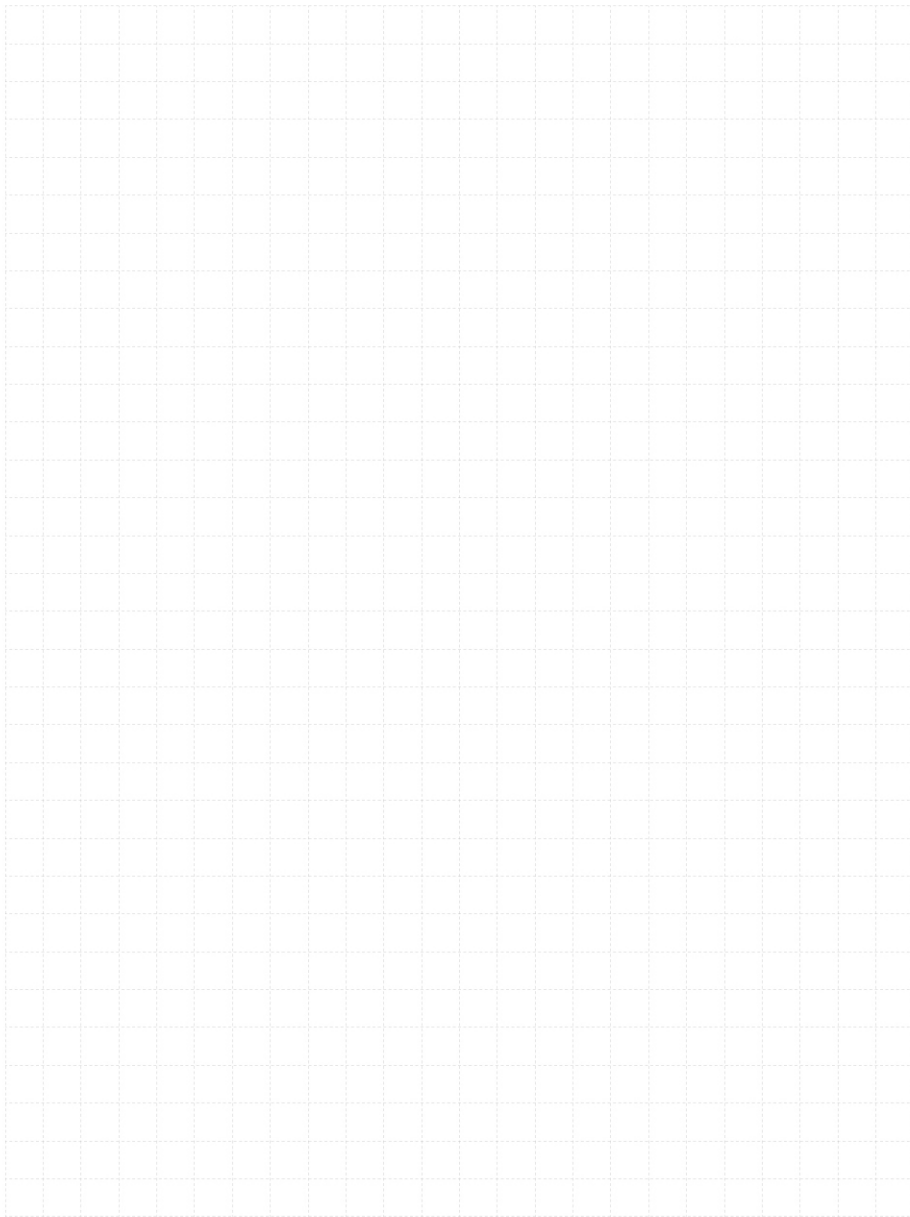

# HSL-3-R expansion anchor

## Ultimate-performance heavy-duty expansion anchor

Anchor versions		Benefits
		<ul style="list-style-type: none"> <li>- Suitable for cracked concrete C20/25 to C50/60</li> <li>- Suitable for all dynamic loads: seismic C1, shock and fatigue</li> <li>- Can be installed with hammer or Hollow drilling<sup>a)</sup> for same performance</li> <li>- Top shear performance due to high strength expansion and shear sleeves</li> <li>- Length can be customized to a specific project need</li> <li>- Easily removable for temporary fastening or retrofit</li> </ul>

a) Condition valid only for size M12, M16 & M20

Base material		Load conditions			
Concrete (non-cracked)	Concrete (cracked)	Static/ quasi-static	Seismic ETA-C1	Shock	Fire resistance
Installation conditions		Other information			
Hammer drilled holes	Hollow drill-bits drilling	Variable embedment depth	European Technical Assessment	CE conformity	PROFIS Engineering design Software
					Corrosion resistance

### Approvals/certificates

Description	Authority / Laboratory	No. / Date of issue
European technical Assessment <sup>a)</sup>	CSTB, Marne-la-Vallée	ETA-02/0042 / 2017-11-22
Fire test report	CSTB, Marne-la-Vallée	ETA-02/0042 / 2017-11-22
ICC-ES report incl. seismic <sup>b)</sup>	ICC evaluation service	ESR 1545 / 2019-04
Shock approval	Civil Protection of Switzerland	BZS D 08-601

a) All data given in this section according to ETA-02/0042, issue 2017-07-20.

b) For more details on Technical Data according to ICC please consult the relevant HNA FTM.

**Static and quasi-static resistance (for a single anchor)**
**All data in this section applies to:**

- Correct setting (See setting instruction)
- No edge distance and spacing influence
- Steel failure
- Minimum base material thickness
- Concrete C 20/25,  $f_{ck,cube}=25 \text{ N/mm}^2$
- Values for Hollow drill-bits drilling only applicable for M12, M16 and M20.

**Effective anchorage depth <sup>a)</sup>**

Anchor size		M8			M10			M12		
Effective anchorage depth	$h_{ef}$ [mm]	$h_{ef,1}^{b)}$	$h_{ef,2}^{b)}$	$h_{ef,3}$	$h_{ef,1}^{b)}$	$h_{ef,2}^{b)}$	$h_{ef,3}$	$h_{ef,1}^{b)}$	$h_{ef,2}^{b)}$	$h_{ef,3}$
		60	80	100	70	90	110	80	105	130
Anchor size		M16			M20					
Effective anchorage depth	$h_{ef}$ [mm]	$h_{ef,1}$	$h_{ef,2}$	$h_{ef,3}$	$h_{ef,1}$	$h_{ef,2}$	$h_{ef,3}$			
		100	125	150	125	155	185			

a) HSL-3-SKR only available in sizes M8-M12

b) HSL-3-SKR can only be set in position 1.

**Characteristic resistance**

Anchor size		M8			M10			M12			
<b>Non-cracked concrete</b>											
Tension	HSL-3-R / HSL-3-SKR <sup>a)</sup> HSL-3-GR	$N_{Rk}$ [kN]	20,0	20,0	20,0	28,8	40,6	40,6	35,2	50,0	50,0
			20,0	20,0	20,0	28,8	40,6	40,6	35,2	50,0	50,0
Shear	HSL-3-R / HSL-3-SKR <sup>a)</sup> HSL-3-GR	$V_{Rk}$ [kN]	45,7	50,9	50,9	57,6	63,9	63,9	70,4	82,8	82,8
			40,3	40,3	40,3	58,9	58,9	58,9	70,4	78,7	78,7
<b>Cracked concrete</b>											
Tension	HSL-3-R / HSL-3-SKR <sup>a)</sup> HSL-3-GR	$N_{Rk}$ [kN]	12,0	12,0	12,0	16,0	16,0	16,0	24,6	24,0	24,0
			32,0	49,3	50,9	40,3	58,8	63,9	49,3	74,1	82,8
Shear	HSL-3-R / HSL-3-SKR <sup>a)</sup> HSL-3-GR	$V_{Rk}$ [kN]	32,0	40,3	40,3	40,3	58,8	58,9	49,3	74,1	78,7
			32,0	40,3	40,3	40,3	58,8	58,9	49,3	74,1	78,7
Anchor size		M16			M20						
<b>Non-cracked concrete</b>											
Tension	HSL-3-R / HSL-3-GR	$N_{Rk}$ [kN]	49,2	65,0	65,0	68,8	95,0	95,0			
Shear	HSL-3-R HSL-3-GR	$V_{Rk}$ [kN]	98,4	127,7	127,7	137,5	154,8	154,8			
			98,4	129,5	129,5	137,5	151,9	151,9			
Anchor size		M16			M20						
<b>Cracked concrete</b>											
Tension	HSL-3-R / HSL-3-GR	$N_{Rk}$ [kN]	34,4	36,0	36,0	48,1	50,0	50,0			
Shear	HSL-3-R HSL-3-GR	$V_{Rk}$ [kN]	68,9	96,3	126,5	96,3	132,9	154,8			
			68,9	96,3	126,5	96,3	132,9	151,9			

a) HSL-3-SKR can only be set in position 1.

**Design resistance**

Anchor size		M8			M10			M12				
<b>Non-cracked concrete</b>												
Tension	HSL-3-R / HSL-3-SKR <sup>a)</sup>	N <sub>Rd</sub>	[kN]	13,3	13,3	13,3	19,2	21,7	21,7	23,5	31,6	31,6
	HSL-3-GR			13,3	13,3	13,3	19,2	27,1	27,1	23,5	33,3	33,3
Shear	HSL-3-R / HSL-3-SKR <sup>a)</sup>	V <sub>Rd</sub>	[kN]	30,5	40,7	40,7	38,4	41,0	41,0	46,9	53,1	53,1
	HSL-3-GR			30,5	32,2	32,2	38,4	47,1	47,1	46,9	63,0	63,0
<b>Cracked concrete</b>												
Tension	HSL-3-R / HSL-3-SKR <sup>a)</sup> HSL-3-GR	N <sub>Rd</sub>	[kN]	8,0	8,0	8,0	10,7	10,7	10,7	16,4	16,0	16,0
Shear	HSL-3-R / HSL-3-SKR <sup>a)</sup>	V <sub>Rd</sub>	[kN]	21,3	32,9	40,7	26,9	39,2	41,0	32,9	49,4	53,1
	HSL-3-GR			21,3	32,2	32,2	26,9	39,2	47,1	32,9	49,4	63,0
Anchor size		M16			M20							
<b>Non-cracked concrete</b>												
Tension	HSL-3-R / HSL-3-GR	N <sub>Rd</sub>	[kN]	32,8	43,3	43,3	45,8	63,3	63,3			
Shear	HSL-3-R / HSL-3-GR	V <sub>Rd</sub>	[kN]	65,6	81,9	81,9	91,7	99,2	99,2			
	HSL-3-GR			65,6	91,7	103,6	91,7	121,5	121,5			
<b>Cracked concrete</b>												
Tension	HSL-3-R / HSL-3-GR	N <sub>Rd</sub>	[kN]	23,0	24,0	24,0	33,5	33,3	33,3			
Shear	HSL-3-R	V <sub>Rd</sub>	[kN]	45,9	64,2	81,9	64,2	88,6	99,2			
	HSL-3-GR			45,9	64,2	84,3	64,2	88,6	115,5			

a) HSL-3-SKR only available in sizes M8-M12

**Recommended loads <sup>b)</sup>**

Anchor size		M8			M10			M12				
<b>Non-cracked concrete</b>												
Tension	HSL-3-R / HSL-3-SKR <sup>a)</sup>	N <sub>Rec</sub>	[kN]	9,5	9,5	9,5	13,7	15,5	15,5	16,8	22,5	22,5
	HSL-3-GR			9,5	9,5	9,5	13,7	19,3	19,3	16,8	23,8	23,8
Shear	HSL-3-R / HSL-3-SKR <sup>a)</sup>	V <sub>Rec</sub>	[kN]	21,8	29,1	29,1	27,4	29,3	29,3	33,5	37,9	37,9
	HSL-3-GR			21,8	23,0	23,0	27,4	33,7	33,7	33,5	45,0	45,0
<b>Cracked concrete</b>												
Tension	HSL-3-R / HSL-3-SKR <sup>a)</sup>	N <sub>Rec</sub>	[kN]	5,7	5,7	5,7	7,6	7,6	7,6	11,7	11,4	11,4
	HSL-3-GR			5,7	5,7	5,7	7,6	7,6	7,6	11,7	11,4	11,4
Shear	HSL-3-R / HSL-3-SKR <sup>a)</sup>	V <sub>Rec</sub>	[kN]	15,2	23,5	29,1	19,2	28,0	29,3	23,5	35,3	37,9
	HSL-3-GR			15,2	23,0	23,0	19,2	28,0	33,7	23,5	35,3	45,0
Anchor size		M16			M20							
<b>Non-cracked concrete</b>												
Tension	HSL-3-R / HSL-3-GR	N <sub>Rec</sub>	[kN]	23,4	31,0	31,0	32,7	45,2	45,2			
Shear	HSL-3-R / HSL-3-GR	V <sub>Rec</sub>	[kN]	46,9	58,5	58,5	65,5	70,9	70,9			
	HSL-3-GR			46,9	65,5	74,0	65,5	86,8	86,8			
<b>Cracked concrete</b>												
Tension	HSL-3-R / HSL-3-GR	N <sub>Rec</sub>	[kN]	16,4	17,1	17,1	22,9	23,8	23,8			
Shear	HSL-3-R	V <sub>Rec</sub>	[kN]	32,8	45,8	58,5	45,8	63,3	70,9			
	HSL-3-GR			32,8	45,8	60,2	45,8	63,3	82,5			

a) HSL-3-SKR only available in sizes M8-M12.

b) With overall partial safety factor for action  $\gamma = 1,4$ . The partial safety factors for action depend on the type of loading and shall be taken from national regulations.



**Seismic resistance (for a single anchor)**
**All data in this section applies to:**

- Correct setting (See setting instruction)
- No edge distance and spacing influence
- Steel failure
- Minimum base material thickness
- Concrete C 20/25,  $f_{ck,cube}=25 \text{ N/mm}^2$
- $\alpha_{gap} = 0,5$
- Values for Hollow drill-bits drilling only applicable for M12, M16 and M20

**Effective anchorage depth for seismic C1 <sup>a)</sup>**

Anchor size		M8			M10			M12		
Effective anchorage depth	$h_{ef}$ [mm]	$h_{ef,1}^{b)}$	$h_{ef,2}^{b)}$	$h_{ef,3}$	$h_{ef,1}^{b)}$	$h_{ef,2}^{b)}$	$h_{ef,3}$	$h_{ef,1}^{b)}$	$h_{ef,2}^{b)}$	$h_{ef,3}$
		60	80	100	70	90	110	80	105	130
Anchor size		M16			M20					
Effective anchorage depth	$h_{ef}$ [mm]	$h_{ef,1}$	$h_{ef,2}$	$h_{ef,3}$	$h_{ef,1}$	$h_{ef,2}$	$h_{ef,3}$			
		100	125	150	125	155	185			

a) HSL-3-SKR only available in sizes M8-M12

b) HSL-3-SKR can only be set in position 1.

**Characteristic resistance in case of seismic category C1**

Anchor size		M8			M10			M12			
Tension	HSL-3-R / HSL-3-GR / HSL-3-SKR	$N_{Rk,seis}$ [kN]	12,0	12,0	12,0	16,0	16,0	16,0	20,9	24,0	24,0
Shear	HSL-3-GR	$V_{Rk,seis}$ [kN]	5,2	5,2	5,2	12,9	12,9	12,9	14,0	14,0	14,0
	HSL-3-R / HSL-3-SKR		5,2	5,2	5,2	12,9	12,9	12,9	14,0	14,0	14,0
Anchor size		M16			M20						
Tension	HSL-3-R / HSL-3-GR / HSL-3-SKR	$N_{Rk,seis}$ [kN]	29,3	36,0	36,0	40,9	50,0	50,0			
Shear	HSL-3-GR	$V_{Rk,seis}$ [kN]	29,3	29,6	29,6	29,6	29,6	29,6			
	HSL-3-R / HSL-3-SKR		29,3	29,6	29,6	29,6	29,6	29,6			

**Design resistance in case of seismic category C1**

Anchor size		M8			M10			M12			
Tension	HSL-3-R / HSL-3-GR / HSL-3-SKR	$N_{Rd,seis}$ [kN]	8,0	8,0	8,0	10,7	10,7	10,7	14,0	16,0	16,0
Shear	HSL-3-GR	$V_{Rd,seis}$ [kN]	4,2	4,2	4,2	10,3	10,3	10,3	11,2	11,2	11,2
	HSL-3-R / HSL-3-SKR		4,2	4,2	4,2	8,3	8,3	8,3	9,0	9,0	9,0
Anchor size		M16			M20						
Tension	HSL-3-R / HSL-3-GR / HSL-3-SKR	$N_{Rd,seis}$ [kN]	19,5	24,0	24,0	27,3	33,3	33,3			
Shear	HSL-3-GR	$V_{Rd,seis}$ [kN]	19,5	23,7	23,7	23,7	23,7	23,7			
	HSL-3-R / HSL-3-SKR		19,0	19,0	19,0	19,0	19,0	19,0			

**Fire resistance**
**All data in this section applies to:**

- Correct setting (See setting instruction)
- No edge distance and spacing influence
- Steel failure
- Minimum base material thickness
- Concrete C 20/25,  $f_{ck,cyl} = 20 \text{ N/mm}^2$
- partial safety factor for resistance under fire exposure  $\gamma_{M,fi}=1,0$  (in absence of other national regulations)

**Effective anchorage depth<sup>a)</sup>**

Anchor size		M8			M10			M12		
Effective anchorage depth	$h_{ef}$ [mm]	$h_{ef,1}^{b)}$	$h_{ef,2}^{b)}$	$h_{ef,3}$	$h_{ef,1}^{b)}$	$h_{ef,2}^{b)}$	$h_{ef,3}$	$h_{ef,1}^{b)}$	$h_{ef,2}^{b)}$	$h_{ef,3}$
		60	80	100	70	90	110	80	105	130
Anchor size		M16			M20					
Effective anchorage depth	$h_{ef}$ [mm]	$h_{ef,1}$	$h_{ef,2}$	$h_{ef,3}$	$h_{ef,1}$	$h_{ef,2}$	$h_{ef,3}$			
		100	125	150	125	155	185			

a) HSL-3-SKR only available in sizes M8-M12

b) HSL-3-SKR can only be set in position 1.

**Characteristic resistance**

Anchor size		M8			M10			M12			
<b>Fire exposure R30</b>											
Tension	HSL-3-R / HSL-3-GR / HSL-3-SKR	$N_{Rk,fi}$ [kN]	0,7	0,7	0,7	1,5	1,5	1,5	2,5	2,5	2,5
Shear	HSL-3-R / HSL-3-GR / HSL-3-SKR	$V_{Rk,fi}$ [kN]	0,7	0,7	0,7	1,5	1,5	1,5	2,5	2,5	2,5
<b>Fire exposure R120</b>											
Tension	HSL-3-R / HSL-3-GR / HSL-3-SKR	$N_{Rk,fi}$ [kN]	0,4	0,4	0,4	0,8	0,8	0,8	1,3	1,3	1,3
Shear	HSL-3-R / HSL-3-GR / HSL-3-SKR	$V_{Rk,fi}$ [kN]	0,4	0,4	0,4	0,8	0,8	0,8	1,3	1,3	1,3
Anchor size		M16			M20						
<b>Fire exposure R30</b>											
Tension	HSL-3-R / HSL-3-GR / HSL-3-SKR	$N_{Rk,fi}$ [kN]	4,7	4,7	4,7	7,4	7,4	7,4			
Shear	HSL-3-R / HSL-3-GR / HSL-3-SKR	$V_{Rk,fi}$ [kN]	4,7	4,7	4,7	7,4	7,4	7,4			
<b>Fire exposure R120</b>											
Tension	HSL-3-R / HSL-3-GR / HSL-3-SKR	$N_{Rk,fi}$ [kN]	2,5	2,5	2,5	3,9	3,9	3,9			
Shear	HSL-3-R / HSL-3-GR / HSL-3-SKR	$V_{Rk,fi}$ [kN]	2,5	2,5	2,5	3,9	3,9	3,9			

**Characteristic resistance**

Anchor size		M8			M10			M12			
<b>Fire exposure R30</b>											
Tension	HSL-3-R / HSL-3-GR / HSL-3-SKR	$N_{Rk,fi}$ [kN]	0,7	0,7	0,7	1,5	1,5	1,5	2,5	2,5	2,5
Shear	HSL-3-R / HSL-3-GR / HSL-3-SKR	$V_{Rk,fi}$ [kN]	0,7	0,7	0,7	1,5	1,5	1,5	2,5	2,5	2,5
<b>Fire exposure R120</b>											
Tension	HSL-3-R / HSL-3-GR / HSL-3-SKR	$N_{Rk,fi}$ [kN]	0,4	0,4	0,4	0,8	0,8	0,8	1,3	1,3	1,3
Shear	HSL-3-R / HSL-3-GR / HSL-3-SKR	$V_{Rk,fi}$ [kN]	0,4	0,4	0,4	0,8	0,8	0,8	1,3	1,3	1,3
Anchor size		M16			M20						
<b>Fire exposure R30</b>											
Tension	HSL-3-R / HSL-3-GR / HSL-3-SKR	$N_{Rk,fi}$ [kN]	4,7	4,7	4,7	7,4	7,4	7,4			
Shear	HSL-3-R / HSL-3-GR / HSL-3-SKR	$V_{Rk,fi}$ [kN]	4,7	4,7	4,7	7,4	7,4	7,4			
<b>Fire exposure R120</b>											
Tension	HSL-3-R / HSL-3-GR / HSL-3-SKR	$N_{Rk,fi}$ [kN]	2,5	2,5	2,5	3,9	3,9	3,9			
Shear	HSL-3-R / HSL-3-GR / HSL-3-SKR	$V_{Rk,fi}$ [kN]	2,5	2,5	2,5	3,9	3,9	3,9			

For more information about different failure modes and fire resistance times please see the full ETA-02/0042 report.

**Materials**
**Mechanical properties**

Anchor size			M8	M10	M12	M16	M20
<b>HSL-3-R, HSL-3-GR, HSL-3-SKR</b>							
Nominal tensile strength	$f_{uk}$	[N/mm <sup>2</sup> ]	700	700	700	700	700
Yield strength	HSL-3-R	$f_{yk}$	[N/mm <sup>2</sup> ]	560	450	450	450
	HSL-3-SKR			560	560	560	560
	HSL-3-GR			560	560	560	560
Stressed cross-section	$A_s$	[mm <sup>2</sup> ]	36,6	58,0	84,3	157	245
Moment of resistance	W	[mm <sup>3</sup> ]	31,3	62,5	109,4	277,1	540,6
Characteristic bending resistance	$M^{0}_{Rk,s}$	[Nm]	26,2	52,3	91,7	233,1	454,4

**Material quality**

Part	Material	
<b>Stainless Steel</b>		
HSL-3-R	Cone	Stainless steel A4, coated
HSL-3-GR	Expansion sleeve	Stainless steel A4
HSL-3-SKR	Collapsible element	Plastic element
	Distance sleeve	Stainless steel A4
HSL-3-R	Washer	Stainless steel A4, coated
	Hexagonal bolt	Stainless steel A4, coated, rupture elongation $\geq 12\%$
HSL-3-GR	Hexagonal nut	Stainless steel A4, coated
	Threaded rod	Stainless steel A4, coated, rupture elongation $\geq 12\%$
HSL-3-SKR	Countersunk bolt	Stainless steel A4, coated, rupture elongation $\geq 12\%$
	Cup washer	Stainless steel A4, coated

**Anchor dimensions of HSL-3-R, HSL-3-GR, HSL-3-SKR**

Anchor version	Thread size	$t_{fix}$ [mm]		$d_s$ [mm]	$l_1$ [mm]	$l_2$ [mm]	$l_3$ [mm]	$l_4$ [mm]		$p$ [mm]
		min	max					min	max	
HSL-3-R	M8	5	200	11,9	12	32	15,2	34	54	2
	M10	5	200	14,8	14	36	17,2	38	58	3
	M12	5	200	17,6	17	40	20	48	73	3
	M16	10	200	23,6	20	54,4	24,4	49,5	74,5	4
	M20	10	200	27,6	20	57	31,5	71	101	4
HSL-3-GR	M8	5	200	11,9	12	32	15,2	34	114	2
	M10	5	200	14,8	14	36	17,2	38	118	3
	M12	5	200	17,6	17	40	20	48	123	3
	M16	10	200	23,6	20	54,4	24,4	49,5	124,5	4
	M20	10	200	27,6	20	57	31,5	71	141	4
HSL-3-SKR	M8	10	20	11,9	12	32	15,2	18,2	28,2	2
	M10	20		14,8	14	36	17,2	32,2		3
	M12	25		17,6	17	40	20	40		3

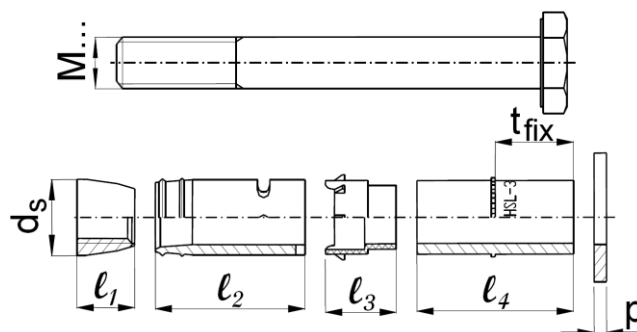
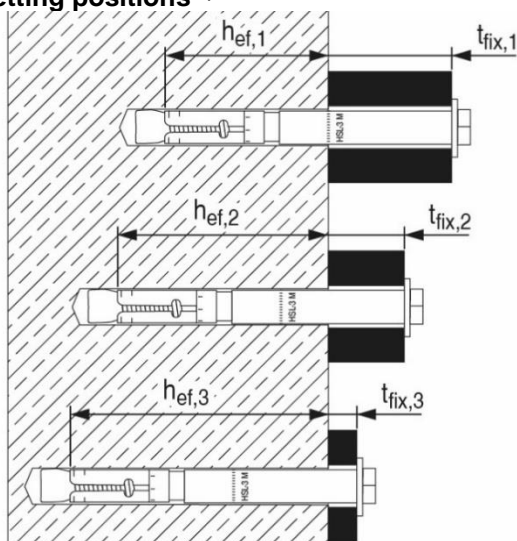
**Setting information**
**Setting positions a)**

Setting position

①

Setting position

②

Setting position

③

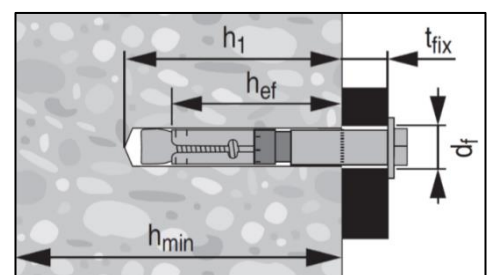

a) HSL-3-SKR can only be set in position 1.

**Setting details for HSL-3-R**

Anchor version		M8			M10			M12		
		①	②	③	①	②	③	①	②	③
Nominal diameter of drill bit	$d_0$ [mm]	12			15			18		
Max. cutting diameter of drill bit	$d_{cut}$ [mm]	12,5			15,5			18,5		
Max. diameter of clearance hole in the fixture	$d_f$ [mm]	14			17			20		
Setting position	$i$	①	②	③	①	②	③	①	②	③
Fixture thickness	$t_{fix,1}$ [mm]	5-200			5-200			5-200		
Effective fixture thickness	$t_{fix,i}$	$t_{fix,1}^{1)} - \Delta i$								
Reduction of fixture thickness	$\Delta i$ [mm]	0	20	40	0	20	40	0	25	50
Effective anchorage depth	$h_{ef,i}$ [mm]	60	80	100	70	90	110	80	105	130
Min. depth of drill hole	$h_{1,i}$ [mm]	80	100	120	90	110	130	105	130	155
Min. thickness of concrete member	$h_{min,i}$ [mm]	120	170	195	140	195	215	160	225	250
Width across flats	SW [mm]	13			17			19		
Installation torque	$T_{inst}$ [Nm]	25			35			80		
Anchor version		M16			M20					
Nominal diameter of drill bit	$d_0$ [mm]	24			28					
Max. cutting diameter of drill bit	$d_{cut}$ [mm]	24,55			28,55					
Max. diameter of clearance hole in the fixture	$d_f$ [mm]	26			31					
Setting position	$i$	①	②	③	①	②	③			
Fixture thickness	$t_{fix,1}$ [mm]	10-200			10-200					
Effective fixture thickness	$t_{fix,i}$	$t_{fix,1}^{1)} - \Delta i$								
Reduction of fixture thickness	$\Delta i$ [mm]	0	25	50	0	30	60			
Effective anchorage depth	$h_{ef,i}$ [mm]	100	125	150	125	155	185			
Min. depth of drill hole	$h_{1,i}$ [mm]	125	150	175	155	185	215			
Min. thickness of concrete member	$h_{min,i}$ [mm]	200	275	300	250	380	410			
Width across flats	SW [mm]	24			30					
Installation torque	$T_{inst}$ [Nm]	120			200					

**Setting details for HSL-3-GR**

Anchor version		M8			M10			M12		
Nominal diameter of drill bit	d <sub>0</sub> [mm]	12			15			18		
Max. cutting diameter of drill bit	d <sub>cut</sub> [mm]	12,5			15,5			18,5		
Max. diameter of clearance hole in the fixture	d <sub>f</sub> [mm]	14			17			20		
Setting position	i	①	②	③	①	②	③	①	②	③
Fixture thickness	t <sub>fix,1</sub> [mm]	5-200			5-200			5-200		
Effective fixture thickness	t <sub>fix,i</sub>	t <sub>fix,1</sub> <sup>1)</sup> - Δi								
Reduction of fixture thickness	Δi [mm]	0	20	40	0	20	40	0	25	50
Effective anchorage depth	h <sub>ef,i</sub> [mm]	60	80	100	70	90	110	80	105	130
Min. depth of drill hole	h <sub>1,i</sub> [mm]	80	100	120	90	110	130	105	130	155
Min. thickness of concrete member	h <sub>min,i</sub> [mm]	120	170	190 <sup>a)</sup> / 195	140	195	215	160	225	250
Width across flats	SW [mm]	13			17			19		
Installation torque	T <sub>inst</sub> [Nm]	30			50			80		
Anchor version		M16			M20					
Nominal diameter of drill bit	d <sub>0</sub> [mm]	24			28					
Max. cutting diameter of drill bit	d <sub>cut</sub> [mm]	24,55			28,55					
Max. diameter of clearance hole in the fixture	d <sub>f</sub> [mm]	26			31					
Setting position	i	①	②	③	①	②	③			
Fixture thickness	t <sub>fix1</sub> [mm]	10-200			10-200					
Effective fixture thickness	t <sub>fix,i</sub>	t <sub>fix,1</sub> <sup>1)</sup> - Δi								
Reduction of fixture thickness	Δi [mm]	0	25	50	0	30	60			
Effective anchorage depth	h <sub>ef,i</sub> [mm]	100	125	150	125	155	185			
Min. depth of drill hole	h <sub>1,i</sub> [mm]	125	150	175	155	185	215			
Min. thickness of concrete member	h <sub>min,i</sub> [mm]	200	275	300	250	380	410			
Width across flats	SW [mm]	24			30					
Installation torque	T <sub>inst</sub> [Nm]	120			200					

**Setting details for HSL-3-SKR <sup>a)</sup>**

Anchor version		M8			M10			M12		
Nominal diameter of drill bit	d <sub>0</sub> [mm]	12			15			18		
Max. cutting diameter of drill bit	d <sub>cut</sub> [mm]	12,5			15,5			18,5		
Max. diameter of clearance hole in the fixture	d <sub>f</sub> [mm]	14			17			20		
Top diameter of countersunk head in the fixture	d <sub>h</sub> [mm]	22,5			25,5			32,9		
Bottom diameter of countersunk head in the fixture	d <sub>h</sub> [mm]	11,4			14,4			17,4		
Height of the countersunk head in the fixture	h <sub>cs</sub> [mm]	5,8			6,0			8,0		
Fixture thickness	t <sub>fix</sub> [mm]	10 – 20			20			25		
Effective anchorage depth	h <sub>ef</sub> [mm]	60			70			80		
Min. depth of drill hole	h <sub>1</sub> [mm]	80			90			105		
Min. thickness of concrete member	h <sub>min</sub> [mm]	120			140			160		
Width across flats	SW [mm]	5			6			8		
Installation torque	T <sub>inst</sub> [Nm]	18			50			80		

a) HSL-3-SKR can only be set in position 1.

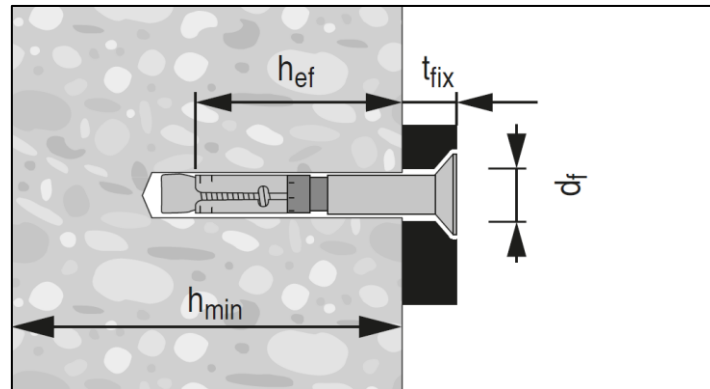

### Installation equipment

Anchor size	M8	M10	M12	M16	M20
Rotary hammer	TE 2 – TE 30			TE 40 – TE 80	
Hollow drill bit	-			TE-CD, TE-YD	
Other tools	blow out pump, hammer, torque wrench				

### Setting parameters for HSL-3-R, HSL-3-GR, HSL-3-SKR

Anchor size		M8			M10			M12			M14			M20		
Setting position	i	①	②	③	①	②	③	①	②	③	①	②	③	①	②	③
Minimum base material thickness	$h_{min}$ [mm]	120	170	195	140	195	215	160	225	250	200	275	300	250	380	410
<b>Non-cracked concrete</b>																
Minimum spacing	$s_{min}$ [mm]	70			70			80			100			125		
	for $c \geq$ [mm]	100			100			160			240			300		
Minimum edge distance	$c_{min}$ [mm]	70			80			80			100			150		
	for $s \geq$ [mm]	140			160			240			240			300		
<b>Cracked concrete</b>																
Minimum spacing	$s_{min}$ [mm]	70			70			80			100			125		
	for $c \geq$ [mm]	100			100			170			240			300		
Minimum edge distance	$c_{min}$ [mm]	70			120			80			100			150		
	for $s \geq$ [mm]	140			160			240			240			300		

**Setting instructions**

\*For detailed information on installation of each specific HSL-3-R/GR/SKR versions see instruction for use given with the package of the product.

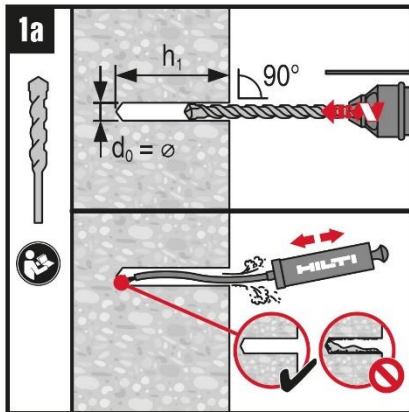
**HSL-3-R / HSL-3-GR**

**Hammer drilled hole**  
Drilling and cleaning

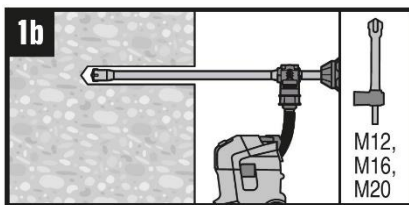

**Hammer drilled hole with Hollow Drilled Bit (HDB)**  
No cleaning required

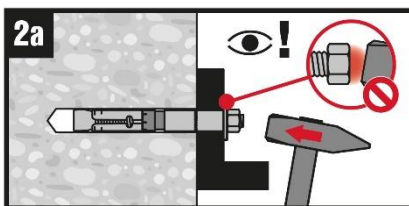

**Insert the anchor with hammer**

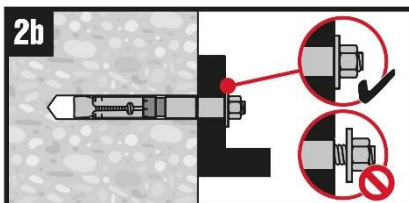

**Check**

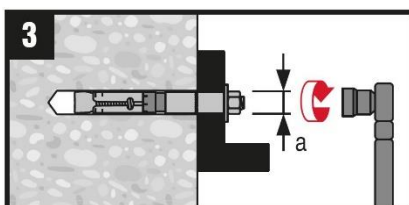

**Applying tightening torque**

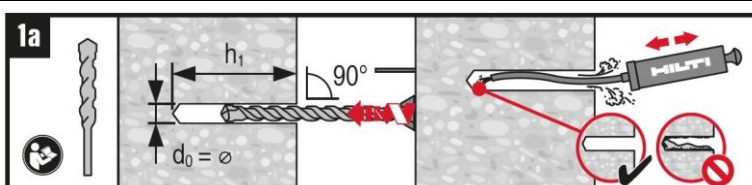
**HSL-3-SKR**

**Hammer drilled hole**  
Drilling and cleaning



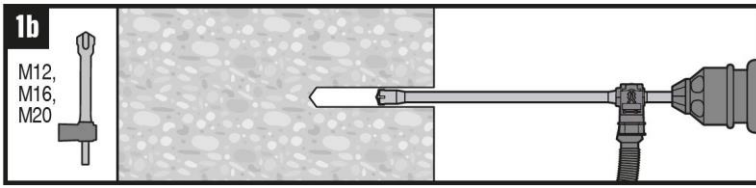

**Hammer drilled hole with Hollow Drilled Bit (HDB)**

No cleaning required

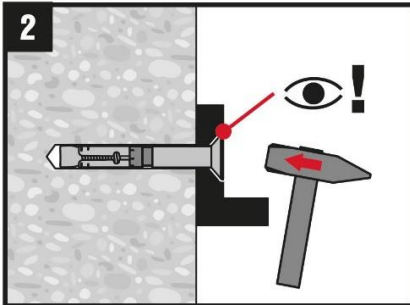

**Insert the anchor with hammer**

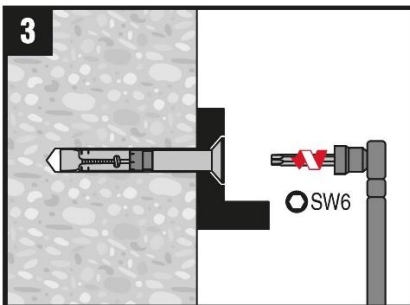

**Applying tightening torque**

## 3.2 Screw anchors



### 3.2.1 HUS4

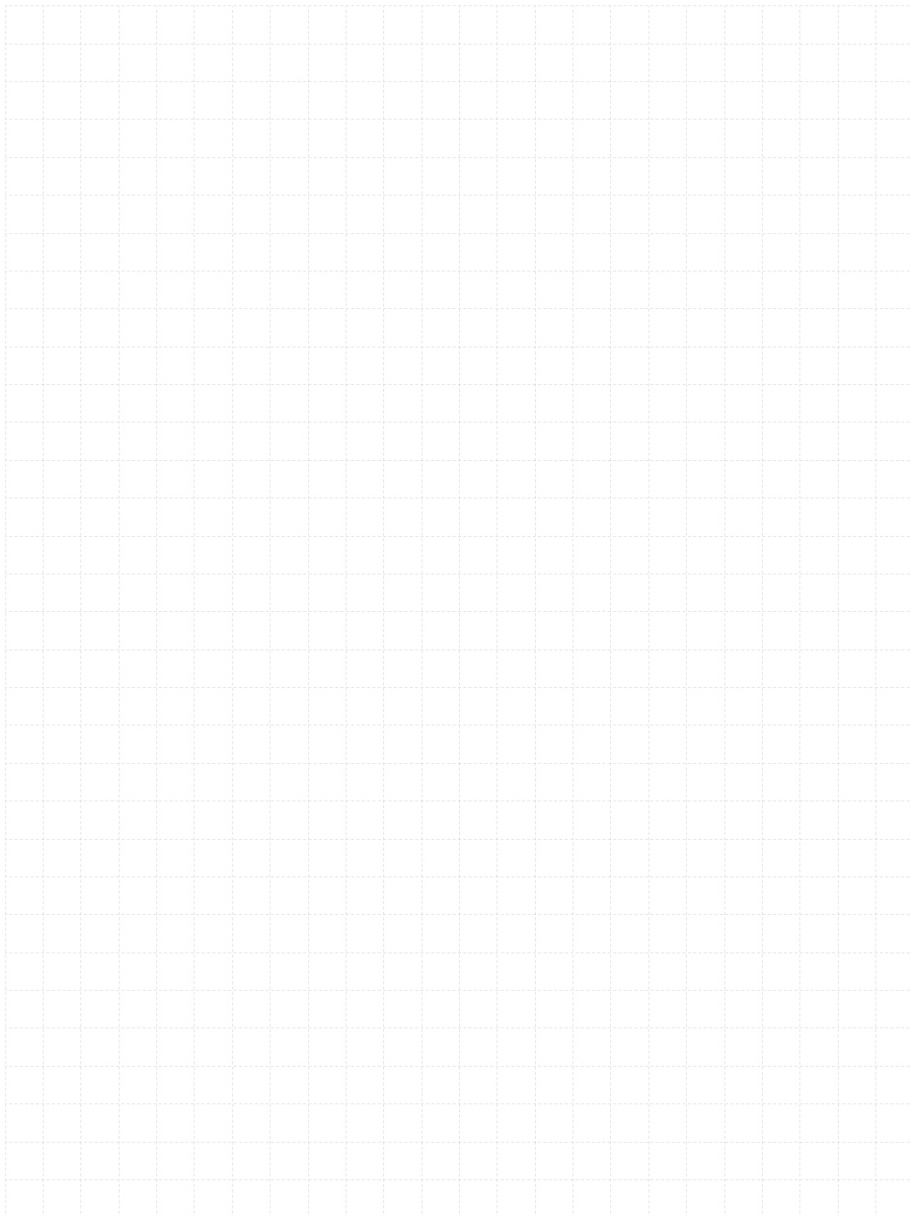





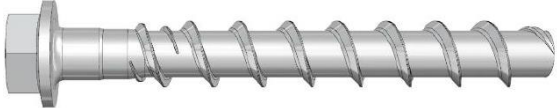

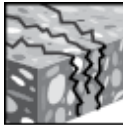

(for HUS4-MAX please refer to the chemical anchor section)

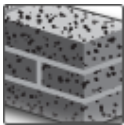
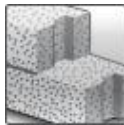
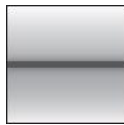

# HUS4 Screw anchor

## Ultimate performance screw anchor for single point fastening

Anchor version		Benefits
	HUS4-H(F) (8-16)*	- High productivity - less drilling and fewer operations than with conventional anchors
	HUS4-C (8-10)	- ETA approval for cracked and non-cracked concrete - ETA approval for Seismic C1 and C2
	HUS4-A(F) (10-14)	- ETA approval for adjustability (unscrew-rescrew) - Smaller edge and spacing distance - aBG (DIBt) approval for reusability in fresh concrete ( $f_{ck, cube} = 10/15/20/25 \text{ Nmm}^2$ ) for temporary applications - Three embedment depths for maximum design flexibility and flexible design for concrete cone capacity - No cleaning required size 8 to 14 - HUS4-HF and HUS4-AF with multilayer coatings for additional corrosion protection - Through fastening with H, A and C head - Pre-fastening with A head

Base material				Load conditions			
							
Concrete (non-cracked)	Concrete (cracked)	Hollow core slabs	Solid brick	Autoclaved aerated concrete	Static / quasi-static	Seismic ETA-C1/C2	Fire resistance
Installation conditions				Other information			
							
Small edge distance and spacing				European Technical Assessment	CE conformity	PROFIS Engineering design software	DIBt Approval Reusability

### Approvals / certificates

Description	Authority	No. / date of issue
European Technical Assessment	DIBt	ETA-20/0867 / 14-04-2022
Fire test report	DIBt	ETA-20/0867 / 14-04-2022
aBG for temporary fastening	DIBt	Z-21.8-2137 / 21-12-2021

\*HUS4-HF not available in size 12

**Static and quasi-static loading data (for a single anchor)**
**All data in this section applies to:**

- Correct setting (See setting instruction)
- No edge distance and spacing influence
- Steel failure
- Minimum base material thickness
- Concrete C 20/25,  $f_{ck,cube} = 25 \text{ N/mm}^2$

**Anchorage depth**

Anchor size		8			10			12			14			16	
Type	HUS4	H, HF, C			H, HF, C, A, AF			H			H, HF, A, AF			H, HF	
		$h_{nom1}$	$h_{nom2}$	$h_{nom3}$	$h_{nom1}$	$h_{nom2}$	$h_{nom3}$	$h_{nom1}$	$h_{nom2}$	$h_{nom3}$	$h_{nom1}$	$h_{nom2}$	$h_{nom3}$	$h_{nom1}$	$h_{nom2}$
Nominal embedment depth	$h_{nom}$ [mm]	40	60	70	55	75	85	60	80	100	65	85	115	85	130

**Characteristic resistance**

Anchor size		8			10			12			14			16	
Type	HUS4	H, HF, C			H, HF, C, A, AF			H			H, HF, A, AF			H, HF	
		$h_{nom1}$	$h_{nom2}$	$h_{nom3}$	$h_{nom1}$	$h_{nom2}$	$h_{nom3}$	$h_{nom1}$	$h_{nom2}$	$h_{nom3}$	$h_{nom1}$	$h_{nom2}$	$h_{nom3}$	$h_{nom1}$	$h_{nom2}$
<b>Non-cracked concrete</b>															
Tension	$N_{Rk}$ [kN]	8,3	16,2	20,7	13,0	22,0	27,6	15,3	24,5	35,1	17,0	26,6	43,3	22,0	46,0
Shear	$V_{Rk}$ [kN]	8,3	18,8	21,9	13,6	28,8	32,0	30,6	38,9	44,9	34,1	53,1	62,0	53,5	73,1
<b>Cracked concrete</b>															
Tension	$N_{Rk}$ [kN]	5,5	11,3	14,5	9,5	15,8	19,3	10,0	17,2	24,6	11,9	18,6	30,3	16,0	32,0
Shear	$V_{Rk}$ [kN]	5,8	18,8	21,9	9,5	28,8	32,0	21,4	34,4	44,9	23,8	37,2	60,6	37,4	73,1

**Design resistance**

Anchor size		8			10			12			14			16	
Type	HUS4	H, HF, C			H, HF, C, A, AF			H			H, HF, A, AF			H, HF	
		$h_{nom1}$	$h_{nom2}$	$h_{nom3}$	$h_{nom1}$	$h_{nom2}$	$h_{nom3}$	$h_{nom1}$	$h_{nom2}$	$h_{nom3}$	$h_{nom1}$	$h_{nom2}$	$h_{nom3}$	$h_{nom1}$	$h_{nom2}$
<b>Non-cracked concrete</b>															
Tension	$N_{Rd}$ [kN]	5,6	10,8	13,8	7,2	14,7	18,4	10,2	16,4	23,4	11,4	17,7	28,8	14,7	30,7
Shear	$V_{Rd}$ [kN]	5,6	15,0	17,5	9,1	23,0	25,6	20,4	31,1	35,9	22,7	35,4	49,6	35,6	58,5
<b>Cracked concrete</b>															
Tension	$N_{Rd}$ [kN]	3,7	7,5	9,6	5,3	10,5	12,9	6,7	11,5	16,4	7,9	12,4	20,2	10,7	21,3
Shear	$V_{Rd}$ [kN]	3,9	15,0	17,5	6,4	21,1	25,6	14,3	22,9	32,8	15,9	24,8	40,4	25,0	49,3

**Recommended loads**

Anchor size		8			10			12			14			16	
Type	HUS4	H, HF, C			H, HF, C, A, AF			H			H, HF, A, AF			H, HF	
		$h_{nom1}$	$h_{nom2}$	$h_{nom3}$	$h_{nom1}$	$h_{nom2}$	$h_{nom3}$	$h_{nom1}$	$h_{nom2}$	$h_{nom3}$	$h_{nom1}$	$h_{nom2}$	$h_{nom3}$	$h_{nom1}$	$h_{nom2}$
<b>Non-cracked concrete</b>															
Tension	$N_{Rec}$ [kN]	4,0	7,7	9,8	5,2	10,5	13,1	7,3	11,7	16,7	8,1	12,6	20,6	10,5	21,9
Shear	$V_{Rec}$ [kN]	4,0	10,7	12,5	6,5	16,5	18,3	14,6	22,2	25,7	16,2	25,3	35,4	25,5	41,8
<b>Cracked concrete</b>															
Tension	$N_{Rec}$ [kN]	2,6	5,4	6,9	3,8	7,5	9,2	4,8	8,2	11,7	5,7	8,9	14,4	7,6	15,2
Shear	$V_{Rec}$ [kN]	2,8	10,7	12,5	4,5	15,1	18,3	10,2	16,4	23,4	11,4	17,7	28,8	17,8	35,2

With overall partial safety factor for action  $\gamma = 1,4$ . The partial safety factors for action depend on the type of loading and shall be taken from national regulations.

**Seismic loading data (for single anchor)**
**All data in this section applies to:**

- Correct setting (See setting instruction)
- No edge distance and spacing influence
- Steel failure
- Minimum base material thickness
- Concrete C 20/25,  $f_{ck,cube} = 25 \text{ N/mm}^2$
- $\alpha_{gap} = 1,0$  (using Hilti seismic filling set) or  $\alpha_{gap} = 0,5$  (without using Hilti seismic filling set) accordingly

Anchor size		8	10	12	14
Nominal embedment depth	$h_{nom}$ [mm]	$h_{nom3}$	$h_{nom3}$	$h_{nom3}$	$h_{nom3}$
		70	85	100	115

**Characteristic resistance in case of seismic performance category C2**

Anchor size		8	10	12	14
<b>with Hilti filling set (HUS4-H and HUS4-A)</b>					
Type	HUS4	H, HF	H, HF, A, AF	H	H, HF, A, AF
Tension	$N_{Rk,seis}$ [kN]	2,7	5,4	11,4	17,7
Shear	$V_{Rk,seis}$	13,9	21,5	27,2	46,5
<b>without Hilti filling set</b>					
Type	HUS4	H, HF, C	H, HF, C, A, AF	H	H, HF, A, AF
Tension	$N_{Rk,seis}$ [kN]	2,7	5,4	11,4	17,7
Shear	$V_{Rk,seis}$	4,7	6,9	11,3	17,2

**Design resistance in case of seismic performance category C2**

Anchor size		8	10	12	14
<b>with Hilti filling set (HUS4-H and HUS4-A)</b>					
Type	HUS4	H, HF	H, HF, A, AF	H	H, HF, A, AF
Tension	$N_{Rd,seis}$ [kN]	1,8	3,6	7,6	11,8
Shear	$V_{Rd,seis}$	11,1	17,2	21,8	34,3
<b>without Hilti filling set</b>					
Type	HUS4	H, HF, C	H, HF, C, A, AF	H	H, HF, A, AF
Tension	$N_{Rd,seis}$ [kN]	1,8	3,6	7,6	11,8
Shear	$V_{Rd,seis}$	3,8	5,5	9,0	13,8

**Anchorage depth**

Anchor size		8		10		12		14		16	
Type	HUS4	H, HF, C		H, HF, C, A, AF		H		H, HF, A, AF		H, HF	
		$h_{nom2}$	$h_{nom3}$	$h_{nom2}$	$h_{nom3}$	$h_{nom2}$	$h_{nom3}$	$h_{nom2}$	$h_{nom3}$	$h_{nom1}$	$h_{nom2}$
Nominal embedment depth	$h_{nom}$ [mm]	60	70	75	85	80	100	85	115	85	130

**Characteristic resistance in case of seismic performance category C1**

Anchor size		8		10		12		14		16	
Type	HUS4	H, HF, C		H, HF, C, A, AF		H		H, HF, A, AF		H, HF	
		$h_{nom2}$	$h_{nom3}$	$h_{nom2}$	$h_{nom3}$	$h_{nom2}$	$h_{nom3}$	$h_{nom2}$	$h_{nom3}$	$h_{nom2}$	$h_{nom3}$
<b>with Hilti filling set (HUS4-H and HUS4-A)</b>											
Tension	$N_{Rk,seis}$ [kN]	9,6	12,3	13,4	16,4	14,6	20,9	15,8	25,7	7,5	19,0
Shear	$V_{Rk,seis}$ [kN]	18,8	18,8	26,7	26,7	29,2	38,9	22,5	34,5	31,8	25,3
<b>without Hilti filling set</b>											
Tension	$N_{Rk,seis}$ [kN]	9,6	12,3	13,4	16,4	14,6	20,9	15,8	25,7	7,5	19,0
Shear	$V_{Rk,seis}$ [kN]	9,4	9,4	13,4	13,4	14,6	19,5	11,3	17,3	15,9	12,7

**Design resistance in case of seismic performance category C1**

Anchor size		8		10		12		14		16	
Type	HUS4	H, HF, C		H, HF, C, A, AF		H		H, HF, A, AF		H, HF	
		$h_{nom2}$	$h_{nom3}$	$h_{nom2}$	$h_{nom3}$	$h_{nom2}$	$h_{nom3}$	$h_{nom2}$	$h_{nom3}$	$h_{nom2}$	$h_{nom3}$
<b>with Hilti filling set (HUS4-H and HUS4-A)</b>											
Tension	$N_{Rd,seis}$ [kN]	6,4	8,2	9,0	10,9	9,7	13,9	10,5	17,2	5,0	12,7
Shear	$V_{Rd,seis}$ [kN]	12,8	15,0	17,9	21,4	19,5	27,9	18,0	27,6	21,2	20,2
<b>without Hilti filling set</b>											
Tension	$N_{Rd,seis}$ [kN]	6,4	8,2	9,0	10,9	9,7	13,9	10,5	17,2	5,0	12,7
Shear	$V_{Rd,seis}$ [kN]	6,4	7,5	9,0	10,7	9,7	13,9	9,0	13,8	10,6	10,1

## Fire resistance

### All data in this section applies to:

- Correct setting (see setting instruction)
- No edge distance and spacing influence
- Steel failure
- Minimum base material thickness
- Partial safety factor for resistance under fire exposure  $\gamma_{M,fi}=1,0$  (in absence of other national regulations)
- For more fire resistance data please see ETA-20/0867.

### Anchorage depth

Anchor size		8						10								
Type	HUS4	H, HF			C			H, HF			C			A		
Nominal embedment depth	$h_{nom}$ [mm]	$h_{nom1}$	$h_{nom2}$	$h_{nom3}$	$h_{nom1}$	$h_{nom2}$	$h_{nom3}$	$h_{nom1}$	$h_{nom2}$	$h_{nom3}$	$h_{nom1}$	$h_{nom2}$	$h_{nom3}$	$h_{nom1}$	$h_{nom2}$	$h_{nom3}$
		40	60	70	40	60	70	55	75	85	55	75	85	55	75	85

### Characteristic resistance

Anchor size		8						10								
Type	HUS4	H, HF			C			H, HF			C			A		
<b>Fire exposure R30</b>																
Tension	$N_{RK,fi}$ [kN]	0,8	2,6	2,6	0,5	0,5	0,5	2,0	3,9	4,2	1,0	1,0	1,0	2,0	3,9	4,2
Shear	$V_{RK,fi}$ [kN]	0,9	2,6	2,6	0,5	0,5	0,5	2,0	3,9	4,2	1,0	1,0	1,0	2,0	4,2	4,2
<b>Fire exposure R120</b>																
Tension	$N_{RK,fi}$ [kN]	0,7	0,9	0,9	0,2	0,2	0,2	1,5	1,7	1,7	0,6	0,6	0,6	1,6	2,1	2,1
Shear	$V_{RK,fi}$ [kN]	0,7	0,9	0,9	0,2	0,2	0,2	1,5	1,7	1,7	0,6	0,6	0,6	1,6	2,1	2,1

### Design resistance

Anchor size		8						10								
Type	HUS4	H, HF			C			H, HF			C			A		
<b>Fire exposure R30</b>																
Tension	$N_{Rd,fi}$ [kN]	0,8	2,6	2,6	0,5	0,5	0,5	2,0	3,9	4,2	1,0	1,0	1,0	2,0	3,9	4,2
Shear	$V_{Rd,fi}$ [kN]	0,9	2,6	2,6	0,5	0,5	0,5	2,0	3,9	4,2	1,0	1,0	1,0	2,0	4,2	4,2
<b>Fire exposure R120</b>																
Tension	$N_{Rd,fi}$ [kN]	0,7	0,9	0,9	0,2	0,2	0,2	1,5	1,7	1,7	0,6	0,6	0,6	1,6	2,1	2,1
Shear	$V_{Rd,fi}$ [kN]	0,7	0,9	0,9	0,2	0,2	0,2	1,5	1,7	1,7	0,6	0,6	0,6	1,6	2,1	2,1

**Anchorage depth**

Anchor size		12			14						16	
Type	HUS4	H, HF			H, HF			A			H, HF	
Nominal embedment depth	$h_{nom}$ [mm]	$h_{nom1}$	$h_{nom2}$	$h_{nom3}$	$h_{nom1}$	$h_{nom2}$	$h_{nom3}$	$h_{nom1}$	$h_{nom2}$	$h_{nom3}$	$h_{nom1}$	$h_{nom2}$
				40	60	70	40	60	70	55	75	85

**Anchorage depth**

Anchor size		12			14						16	
Type	HUS4	H, HF			H, HF			A			H, HF	
<b>Fire exposure R30</b>												
Tension	$N_{Rk,fi}$ [kN]	2,4	4,2	6,1	2,9	4,5	7,5	2,9	4,5	7,5	4,6	8,7
Shear	$V_{Rk,fi}$ [kN]	4,9	7,6	7,6	5,9	10,4	10,5	5,9	8,4	8,4	10,6	10,7
<b>Fire exposure R120</b>												
Tension	$N_{Rk,fi}$ [kN]	1,9	3,0	3,1	2,3	3,6	4,4	2,3	3,6	4,3	3,7	4,5
Shear	$V_{Rk,fi}$ [kN]	2,8	3,0	3,1	3,9	4,2	4,4	4,3	4,3	4,3	4,3	4,5

**Anchorage depth**

Anchor size		12			14						16	
Type	HUS4	H, HF			H, HF			A			H, HF	
<b>Fire exposure R30</b>												
Tension	$N_{Rd,fi}$ [kN]	2,4	4,2	6,1	2,9	4,5	7,5	2,9	4,5	7,5	4,6	8,7
Shear	$V_{Rd,fi}$ [kN]	4,9	7,6	7,6	5,9	10,4	10,5	5,9	8,4	8,4	10,6	10,7
<b>Fire exposure R120</b>												
Tension	$N_{Rd,fi}$ [kN]	1,9	3,0	3,1	2,3	3,6	4,4	2,3	3,6	4,3	3,7	4,5
Shear	$V_{Rd,fi}$ [kN]	2,8	3,0	3,1	3,9	4,2	4,4	4,3	4,3	4,3	4,3	4,5



## Materials

### Mechanical properties

Anchor size		8	10	12	14	16
Nominal tensile strength	$f_{uk}$ [N/mm <sup>2</sup> ]	758	799	767	728	622
Yield strength	$f_{yk}$ [N/mm <sup>2</sup> ]	606	639	613	582	494
Stressed cross-section	$A_s$ [mm <sup>2</sup> ]	47,5	68,9	103	139	173
Moment of resistance	$W$ [mm <sup>3</sup> ]	35	67	130	213	321
Characteristic bending resistance	$M^0_{Rk,s}$ [Nm]	32	64	120	186	240

### Material quality

Type	Material
HUS4 - H, A, C	Carbon steel, galvanized
HUS4 - HF, AF	Carbon steel, multi-layer coating <sup>a)</sup>

a) Multi-layer coating provides a higher corrosion resistance compared to regular hot dip galvanized (HDG) systems with a 40µm coating thickness.

### Head configuration

Type	Part	
HUS4-H HUS4-HF	Hexagonal head	
HUS4-C	Countersunk head	
HUS4-A	External thread	 Hilti HUS4-A, size 10 with external thread M12 and size 14 with external thread M16

### Fastener dimensions and marking HUS4-H(F)

Anchor size		8	10	12	14	16
Type	HUS4	H, HF	H, HF	H	H, HF	H, HF
Outer diameter of screw thread	$d_t$ [mm]	10,50	12,70	14,70	16,70	18,80
Diameter of integrated washer	$d_i$ [mm]	17,50	20,50	23,60	29,00	32,60
Length of the screw (min/max)	$L$ [mm]	45/150	60/305	70/150	75/150	100/205

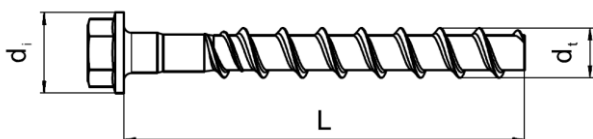

**HUS4:** Hilti Universal Screw 4<sup>th</sup> generation  
**H:** Hexagonal head  
**10:** Screw diameter  
**100:** total length of the screw

**Fastener dimensions and marking HUS4-C**

Anchor size		8	10
Type		C	C
Outer diameter of the screw thread	$d_t$ [mm]	10,50	12,70
Countersunk head diameter	$d_h$ [mm]	18,00	21,00
Length of the screw (min/max)	L [mm]	55/85	70/120

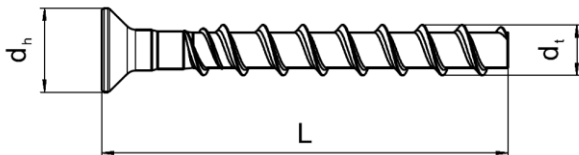

**HUS4:** Hilti Universal Screw 4<sup>th</sup> generation  
**C:** Countersunk head  
**10:** Screw diameter  
**100:** total length of the screw

**Fastener dimensions and marking HUS4-A(F)**

Anchor size		10	14
Type		A, AF	A, AF
Outer diameter of the screw thread	$d_t$ [mm]	12,70	16,70
Diameter of the metric thread	$d_M$ [mm]	M12	M16
Length of the screw (min/max)	L [mm]	120/165	155/205

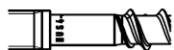
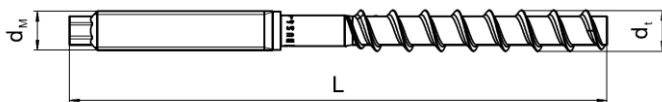

E.g. HUS4-A 10x165



**HUS4:** Hilti Universal Screw 4<sup>th</sup> generation  
**A:** Threaded head  
**10:** Screw diameter  
**100:** total length of the screw  
**8:** carbon steel 8.8  
**K:** length of the screw (more info in ETA)

**Setting information**
**Setting details size 8-12**

Anchor size		8			10			12		
Type	HUS4	H, HF, C			H, HF, C, A, AF			H		
Nominal embedment depth	[mm]	$h_{nom1}$	$h_{nom2}$	$h_{nom3}$	$h_{nom1}$	$h_{nom2}$	$h_{nom3}$	$h_{nom1}$	$h_{nom2}$	$h_{nom3}$
		40	60	70	55	75	85	60	80	100
Nominal diameter of drill bit	$d_0$ [mm]	8			10			12		
Clearance hole diameter	$d_f \leq$ [mm]	12			14			16		
Wrench size HEX head	SW1 [mm]	13			15			17		
Wrench size Threaded head	SW1 [mm]	-			8			-		
Wrench size for nut on Threaded head	SW2 [mm]	-			19			-		
Torx size "C" head	TX -	45			50			-		
Countersunk head diameter	$d_h$ [mm]	18			21					
Depth of drill hole for cleaned hole; or uncleaned hole overhead	$h_1 \geq$ [mm]	50	70	80	65	85	95	70	90	110
Depth of drill hole for uncleaned hole hammer drilling in wall and floor position	$h_1 \geq$ [mm]	66	86	96	85	105	115	94	114	134

**Setting details size 14-16**

Anchor size		14			16	
Type	HUS4	H, HF, A, AF			H, HF	
Nominal embedment depth [mm]	[mm]	$h_{nom1}$	$h_{nom2}$	$h_{nom3}$	$h_{nom1}$	$h_{nom2}$
		65	85	115	85	130
Nominal diameter of drill bit	$d_0$ [mm]	14			16	
Clearance hole diameter	$d_f \leq$ [mm]	18			20	
Wrench size Hex head	SW1 [mm]	21			24	
Wrench size Threaded head	SW1 [mm]	12			-	
Wrench size for nut on Threaded head	SW2 [mm]	24			-	
Depth of drill hole for cleaned hole; or uncleaned hole overhead	$h_1 \geq$ [mm]	75	95	125	95	140
Depth of drill hole for uncleaned hole hammer drilling in wall and floor position	$h_1 \geq$ [mm]	103	123	153	-	-

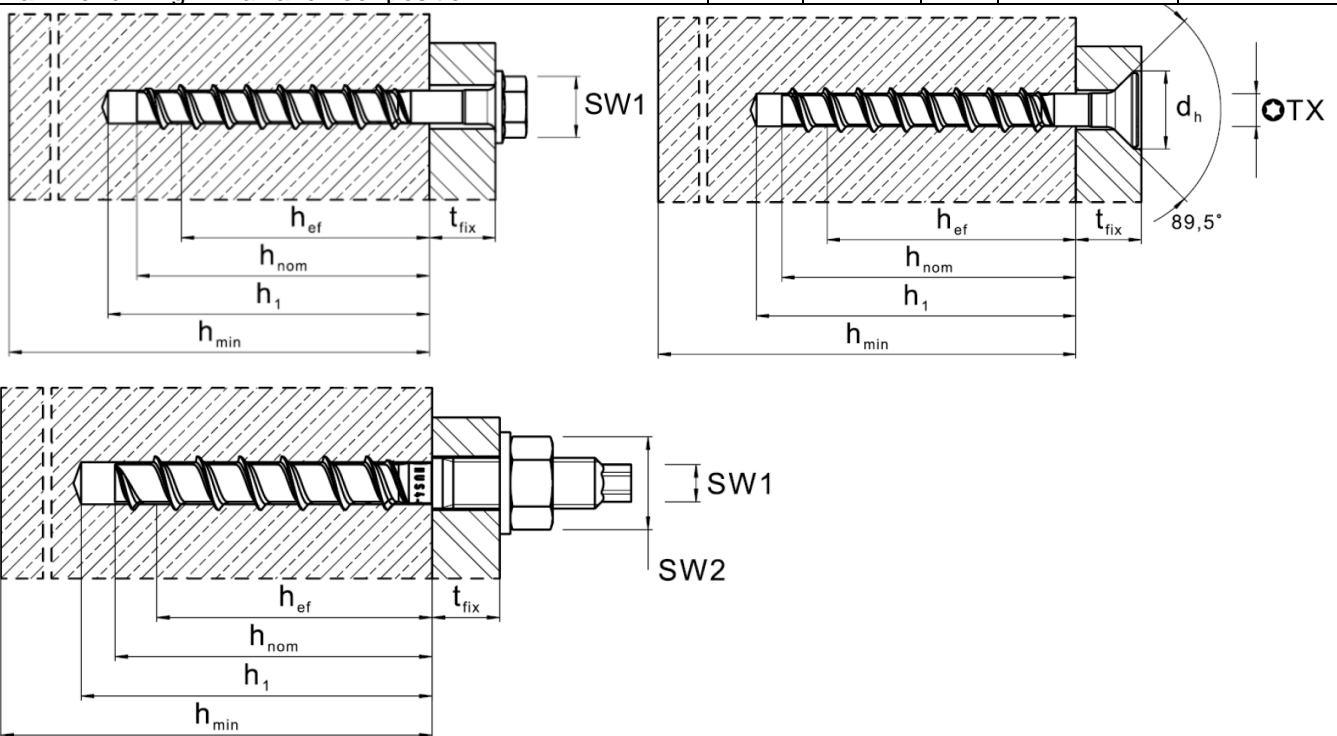

**Installation equipment table:**

Anchor size	8	10	12	14	16
Type	HUS4- H,C,HF	H,HF, C, A, AF	H	H,HF, A, AF	H,HF
Rotary hammer	TE4 – TE30				
Drill bit for concrete, solid clay brick and solid sand-lime brick	TE-CX 8	TE-CX 10	TE-CX 12	TE-CX 14	TE-CX 16
Socket wrench insert for hex screw (SW1)	SI-S 1/2" 13S	SI-S 1/2" 15S	S 1/2" 17S	SI-S 1/2" 21S	S 1/2" 24S
Socket wrench insert for threaded head screw	-	SI-S 1/2" 8S	-	SI-S 1/2" 12S	-
Socket wrench insert for nuts for threaded head screw (SW2)	-	SI-S 1/2" 19S	-	SI-S 1/2" 24S	-
Torx bit for countersunk screw	S-SY TX45	S-SY TX50	-	-	-
Check gauge for reusability <sup>1)</sup>	HRG 8	HRG 10	HRG 12	HRG 14	HRG 16
Setting tool for cracked and uncracked concrete	SIW 6AT-A22 1/2" SIW 4AT-22 1/2" SIW 6-22 1/2" gear 1	SIW 22T-A 1/2" SIW 22T-A 3/4" SIW 6AT-A22 1/2" SIW 4AT-22 1/2" SIW 6-22 1/2" SIW 8-22 1/2" gear 1 SIW 9-A22 3/4"	SIW 22T-A 1/2" SIW 22T-A 3/4" SIW 6-22 1/2" SIW 8-22 1/2" SIW 9-A22 3/4"		
Setting tool for solid brick and aerated concrete	SIW 6AT-A22 1/2", SIW 4AT-22 1/2"		-		
Setting tool for hollow core slab	SIW 6AT-A22 1/2" SIW 4AT-22 1/2"	SIW 6AT-A22 1/2" SIW 4AT-22 1/2" SIW 22T-A 1/2" SIW 22T-A 3/4" SIW 6AT-A22 1/2"			

1) For HUS4-A and HUS4-H

**Setting parameters**

Anchor size		8			10			12			14			16	
Type	HUS4														
Nominal embedment depth	$h_{nom}$ [mm]	40	60	70	55	75	85	60	80	100	65	85	115	85	130
Minimum base material thickness	$h_{min}$ [mm]	80	100	120	100	130	140	110	130	150	120	160	200	130	195
Minimum spacing	$s_{min}$ [mm]	35			40			50			60			90	
Minimum edge distance	$c_{min}$ [mm]	35			40			50			60			65	
Critical spacing for splitting failure	$s_{cr,sp}$ [mm]	3 $h_{ef}$			3.3 $h_{ef}$			3.3 $h_{ef}$			3.3 $h_{ef}$				
Critical edge distance for splitting	$c_{cr,sp}$ [mm]	1.5 $h_{ef}$			1.65 $h_{ef}$			1.65 $h_{ef}$			1.65 $h_{ef}$				
Critical spacing for concrete cone failure	$s_{cr,N}$ [mm]	3 $h_{ef}$													
Critical edge distance for concrete cone failure	$c_{cr,N}$ [mm]	1,5 $h_{ef}$													

For spacing (edge distance) smaller than critical spacing (critical edge distance ) the design loads have to be reduced (see system design resistance ).

Critical spacing and critical edge distance for splitting failure apply only for non-cracked concrete. For cracked concrete only the critical spacing and critical edge distance for concrete cone failure are decisive.

**Setting instructions**

\*For detailed information on installation see instruction for use given with the package of the product

**Setting instruction with adjustment**

**A** HUS4-H(F) 14x(L)  $t_{fix,max1} / t_{fix,max2} / t_{fix,max3}$

**1**

	$d_0$ [mm]						
	$\varnothing 14$	$h_{nom1}$	$\geq 65\text{mm}$				
	$\varnothing 14$	$h_{nom2}$	$\geq 85\text{mm}$				
	$\varnothing 14$	$h_{nom3}$	$\geq 115\text{mm}$				
					$h_2$	10mm	40mm
					10mm	10mm	10mm

**2a**

**2b**

**2c**

**2d**

**3a**

**3b**

**3c**

**3d**

**4a**

**4b**

**4c**

**4d**

**5**

**optional**

**7**

	HUS4-H(F) 14
SIW 22-A 1/2" (01)	
SIW 6AT-A22 1/2" (01)	
SIW 22T-A 1/2" (01)	
SIW 22T-A 3/4" (01)	
SIW 9-A22 3/4" (01)	

**6**

**8**

**Basic loading data for temporary application in standard and fresh concrete <28 days old,  $f_{ck,cube} \geq 10 \text{ N/mm}^2$** 
**All data in this section applies to the following conditions:**

- Strength class,  $f_{ck,cube} \geq 10 \text{ N/mm}^2$
- Only temporary use
- Screw is reusable, before each usage it must be checked according to Hilti instruction for use with the suited tube Hilti HRG
- Design resistance is valid for single anchor only
- Design resistance is valid for all load directions and valid for both cracked and non-cracked concrete
- Minimum base material thickness
- No edge distance and spacing influence
- Valid for HUS4-H and HUS4-A
- All data in this section are according to DIBt approval Z-21.8-2137 issue 2021-12-21

Anchor size		HUS4-H (A)	8		10			12			14			16		
			$h_{nom2}$	$h_{nom3}$	$h_{nom1}$	$h_{nom2}$	$h_{nom3}$	$h_{nom1}$	$h_{nom2}$	$h_{nom3}$	$h_{nom1}$	$h_{nom2}$	$h_{nom3}$	$h_{nom1}$	$h_{nom2}$	
Nominal embedment depth	$h_{nom}$	[mm]	75	85	55	75	85	60	80	100	65	85	115	85	115	
Tension	$\frac{f_{ck,cube} \geq 10 \text{ N/mm}^2}{f_{ck,cube} \geq 15 \text{ N/mm}^2}$	$N_{rd}$	[kN]	3,3	4,7	3,3	5,3	6,3	2,6	5,4	7,8	4,4	7,0	12,3	5,5	12,6
			[kN]	4,0	5,7	4,0	6,4	7,8	3,5	7,3	10,6	5,4	8,5	15,0	7,5	17,0
Shear	$\frac{f_{ck,cube} \geq 20 \text{ N/mm}^2}{f_{ck,cube} \geq 25 \text{ N/mm}^2}$	$V_{rd}$	[kN]	4,6	6,6	4,7	7,4	9,0	4,0	8,4	12,2	6,2	9,9	17,3	8,7	19,7
			[kN]	5,1	7,4	5,3	8,3	10,1	4,5	9,4	13,6	6,9	11,1	19,3	9,7	22,0

**Setting details**

Anchor size		HUS4-H (A)	8		10			12			14			16	
			$h_{nom2}$	$h_{nom3}$	$h_{nom1}$	$h_{nom2}$	$h_{nom3}$	$h_{nom1}$	$h_{nom2}$	$h_{nom3}$	$h_{nom1}$	$h_{nom2}$	$h_{nom3}$	$h_{nom1}$	$h_{nom2}$
Nominal embedment depth	$h_{nom}$	[mm]	60	70	55	75	85	60	80	100	65	85	115	85	130
Drilling depth	$h_1 \geq$	[mm]	70	80	65	85	95	70	90	110	75	95	125	95	140
<b>Option 1</b>															
Minimum edge distance	$c_1 \geq$	[mm]	80	100	75	100	115	65	105	135	85	115	180	105	180
Minimum base material thickness	$h_{min} \geq$	[mm]	120	150	115	150	175	110	160	205	130	175	255	160	220
<b>Option 2</b>															
Minimum edge distance	$c_1 \geq$	[mm]	85	110	85	120	135	65	120	160	100	135	300	115	215
Minimum base material thickness	$h_{min} \geq$	[mm]	100	120	100	130	140	110	130	150	120	160	200	130	195
Minimum edge distance	$c_2 \geq$	[mm]	1.5 x $c_1$												
Minimum spacing	$s_{min} \geq$	[mm]	3.0 x $c_1$												
Check gauge			HRG 8		HRG 10			HRG 12			HRG 14			HRG 16	
Diameter of clearance hole for H head	$d_f \leq$	[mm]	14		16			20			22			24	
Diameter of clearance hole for A head	$d_f \leq$	[mm]	-		14			-			18			-	
Socket size H head	SW		13		15			17			21			24	
Socket size A head	SW1 (SW2)		-		8 (17)			-			12 (24)			-	



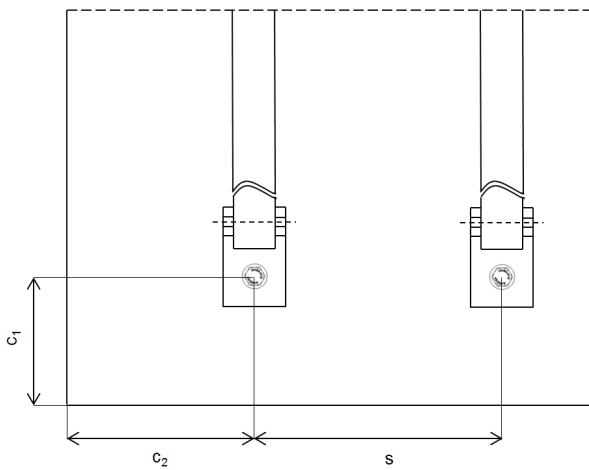
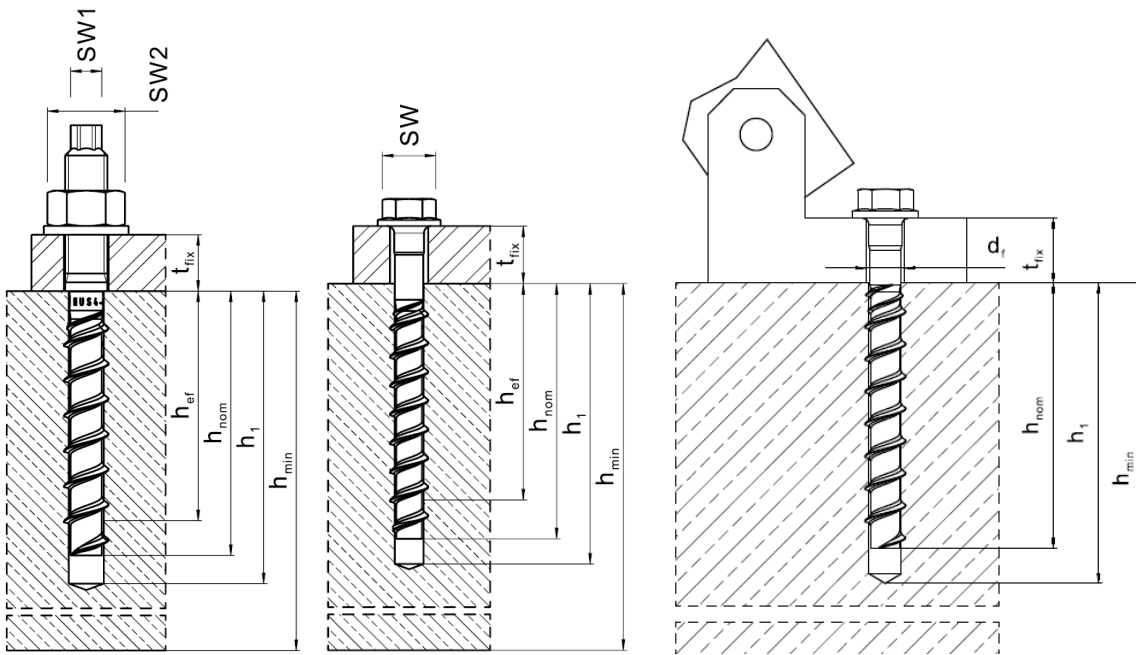

### Setting instructions



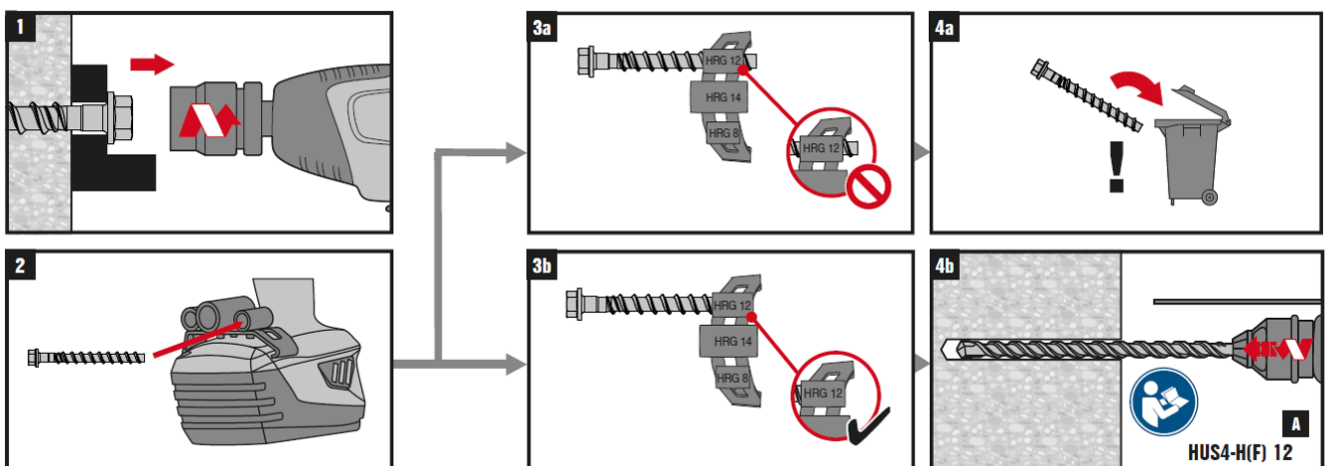

\*For detailed information on installation see instruction for use given with the package of the product example for size 10 screw







**Basic loading data (for a single anchor) in solid masonry units**
**All data in this section applies to:**

- Load values valid for holes drilled with TE rotary hammers (without hammering for PPW)
- Correct anchor setting (see instruction for use, setting details)
- Recommended setting machine: SIW 6AT-A
- The ratio of hollow or holes space to solid may not exceed 15 % of a bed joint area
- The brim area around holes must be at least 70mm
- Edge distances, spacing and other influences, see below
- All data given in this section according to Hilti Technical Data

Anchor size			8	10
Nominal embedment depth	$h_{nom}$	[mm]	60	75
Drilling diameter for Mz, KS	$d_0$	[mm]	8	10
Drilling diameter for Vbl, PPW, Leca5®	$d_0$	[mm]	6	8

Anchor size			8	10
Compressive strength class			H, C, HF	H, C, HF
		[N/mm <sup>2</sup> ]	$N_{rec}$ Tensile loads	
	Solid clay brick Mz 12 / 2,0 (EN 771-1)	≥ 12	1,4	1,4
		≥ 20	1,8	1,8
	Solid sand-lime brick KS 12 / 2,0 (EN 771-2)	≥ 12	3,7	4,2
		≥ 20	4,8	5,4
	Aerated concrete PPW 6-0,4 (EN 771-4)	≥ 6	1,0	1,6
	Solid lightweight concrete brick Vbl, 2DF (EN 771-3) Solid lightweight concrete brick Leca5® Murblock 19 (EN 771-3)	≥ 5	2,0	2,0

Anchor size			8	10
Compressive strength class			H, C, HF	H, C, HF
		[N/mm <sup>2</sup> ]	$V_{rec}$ Shear loads	
	Solid clay brick Mz 12 / 2,0 (EN 771-1)	≥ 12	3,8	5,5
		≥ 20	4,6	5,7
	Solid sand-lime brick KS 12 / 2,0 (EN 771-2)	≥ 12	4,6	5,7
		≥ 20	4,6	5,7
	Aerated concrete PPW 6-0,4 (EN 771-4)	≥ 6	1,3	1,5
	Solid lightweight concrete brick Vbl, 2DF (EN 771-3) Solid lightweight concrete brick Leca5® Murblock 19 (EN 771-3)	≥ 5	2,1	2,8

## Permissible anchor location in brick and block walls

### Edge distance and spacing influence

- The technical data for HUS4 anchors are reference loads for MZ 12, KS 12, Vbl 6, PPW 6 and Leca5®. Due to the large variation of natural stone slid bricks, on site anchor testing is recommended to validate technical data
- The HUS4 anchor was installed and tested in center of solid bricks as shown. The HUS4 anchor was not tested in the mortar joint between solid bricks or in hollow bricks, however a load reduction is expected
- For brick walls where anchor position in brick can not be determined, 100 % anchor testing is recommended
- Distance to free edge free edge to solid masonry (Mz, KS and light weight concrete) units  $\geq 200\text{mm}$
- Distance to free edge free edge to solid masonry (autoclaved aerated gas concrete) units  $\geq 170\text{mm}$
- The minimum distance to horizontal and vertical mortar joint ( $C_{\min}$ ) is started in drawing below
- Minimum anchor spacing ( $s_{\min}$ ) in one brick/block is  $\geq 80\text{ mm}$

### Limits

- All data is for multiple use for non-structural applications
- Plaster, graveling, lining or levelling courses are regarded as non-bearing and may not be taken into account for the calculation of embedment depth
- The decisive resistance to tension loads is the lower value of  $N_{\text{rec}}$  (brick breakout, pull out) and  $N_{\text{max,pb}}$  (pull out of one brick)

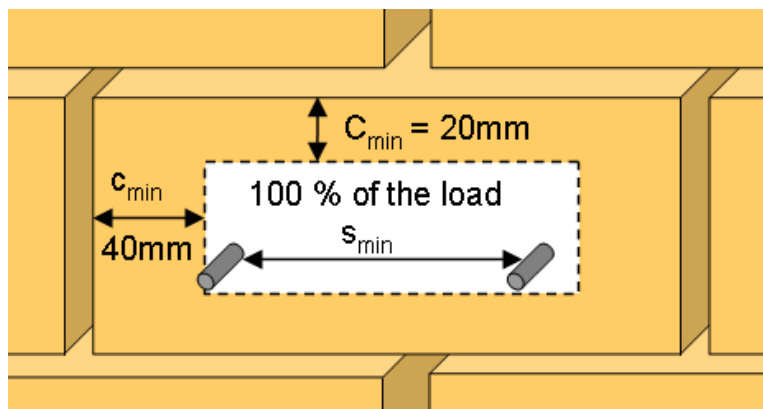

**Basic loading data for single anchor in pre-stressed Hollow core slab (HCS) for permanent fastening**
**All data in this section applies to**

- Correct anchor setting (see instruction for use, setting details)
- Recommended drilling machine: TE2 A22, recommended setting machine: SIW 6AT-A
- No edge distance and spacing influence
- Ratio core width / web thickness  $\leq 5,3$
- Concrete from C30/37, uncracked
- All data given in this section according to Hilti Technical Data

Anchor size			8	10
Nominal embedment depth	$h_{nom}$	[mm]	$d_b$	$d_b$
Drilling depth	$d_0$	[mm]	$\geq d_b + 10 \text{ mm}$	

**Characteristic resistance**

Anchor size		HUS4	8					10				
Concrete strength			C30/37			C45/55		C30/37			C45/55	
Bottom flange thickness	$d_b \geq$	[mm]	30	35	40	35	40	30	35	40	35	40
Tension	$N_{Rk}$	[kN]	2,0	5,8	7,1	7,1	8,7	2,0	5,8	7,1	7,1	8,7
Shear	$V_{Rk}$	[kN]	2,0	9,3	11,4	11,4	14,0	2,0	10,2	12,4	12,5	15,2

**Design resistance**

Anchor size		HUS4	8					10				
Concrete strength			C30/37			C45/55		C30/37			C45/55	
Bottom flange thickness	$d_b \geq$	[mm]	30	35	40	35	40	30	35	40	35	40
Tension	$N_{Rd}$	[kN]	1,3	3,2	3,9	4,0	4,8	1,3	3,2	3,9	4,0	4,8
Shear	$V_{Rd}$	[kN]	1,3	6,2	7,6	7,6	9,3	1,3	6,8	8,3	8,3	10,1

**Recommended loads**

Anchor size		HUS4	8					10				
Concrete strength			C30/37			C45/55		C30/37			C45/55	
Bottom flange thickness	$d_b \geq$	[mm]	30	35	40	35	40	30	35	40	35	40
Tension	$N_{Rec}$	[kN]	0,95	2,3	2,8	2,9	3,4	0,95	2,3	2,8	2,9	3,4
Shear	$V_{Rec}$	[kN]	0,95	4,4	5,4	5,4	6,6	0,95	4,9	5,9	5,9	7,2

With overall partial safety factor for action  $\gamma = 1,4$ . The partial safety factors for action depend on the type of loading and shall be taken from national regulations.

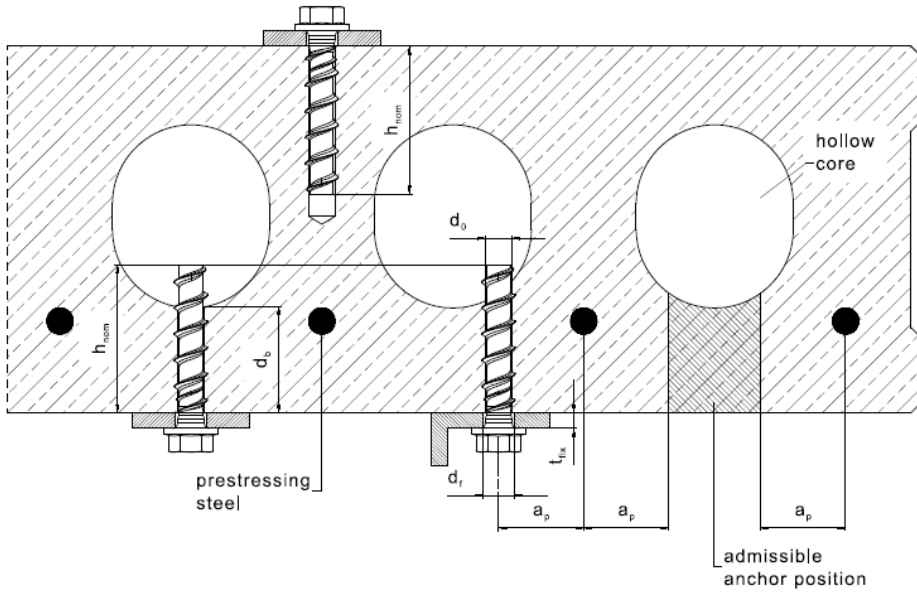

Loads recommendation applies also for installation from top position with no restriction of the admissible anchor position in case of no reinforcement in the related area

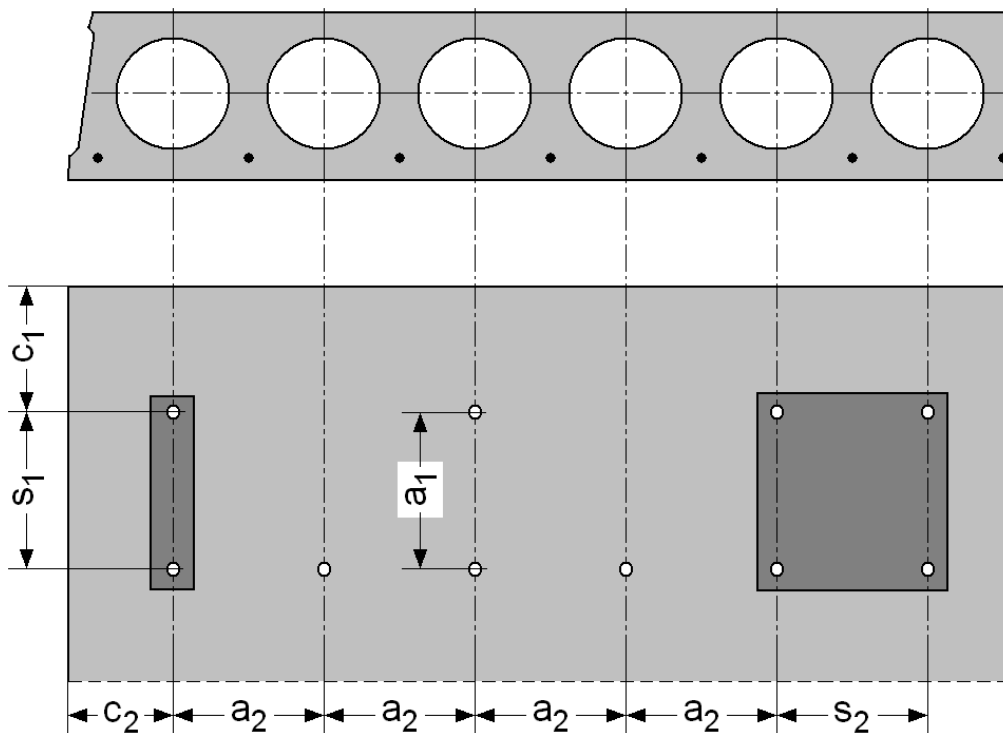

Anchor size		8	10
Type	HUS4	C, H, HF	C, H, HF, A, AF
Minimum and characteristic spacing	$s_{min} = s_{cr}$ [mm]	4 * $d_b$	
Minimum and characteristic edge distance	$c_{min} = c_{cr}$ [mm]	4 * $d_b$	
Minimum group distance	$a_{min}$ [mm]	4 * $d_b$	

Anchor Type	Size [mm]	Length [mm]	$d_b=30$ [mm]		$d_b=35$ [mm]		$d_b=40$ [mm]		$d_b=50$ [mm]	
			$t_{fix,min}$ [mm]	$t_{fix,max}$ [mm]	$t_{fix,min}$ [mm]	$t_{fix,max}$ [mm]	$t_{fix,min}$ [mm]	$t_{fix,max}$ [mm]	$t_{fix,min}$ [mm]	$t_{fix,max}$ [mm]
HUS4-H(F)	8	45	5	10	5	5	-	-	-	-
		55	15	20	15	15	-	-	-	-
		65	5	30	5	25	5	20	5	10
		75	10	40	10	35	10	30	10	20
		85	20	50	20	45	20	40	20	30
		100	35	65	35	60	35	55	35	45
		120	55	85	55	80	55	75	55	65
		150	85	115	85	110	85	105	85	95
HUS4-H(F)	10	60	5	20	5	15	5	10	-	-
		70	15	30	15	25	15	20	-	-
		80	5	40	5	35	5	30	5	20
		90	10	50	10	45	10	40	10	30
		100	20	60	20	55	20	50	20	40
		110	30	70	30	65	30	60	30	50
		130	50	90	50	85	50	80	50	70
		150	70	110	70	105	70	100	70	90

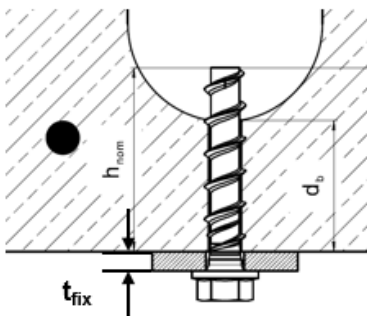

### Setting instructions

\*For detailed information on installation see instruction for use given with the package of the product  
**Installation in Hollow core slabs - example size 10**

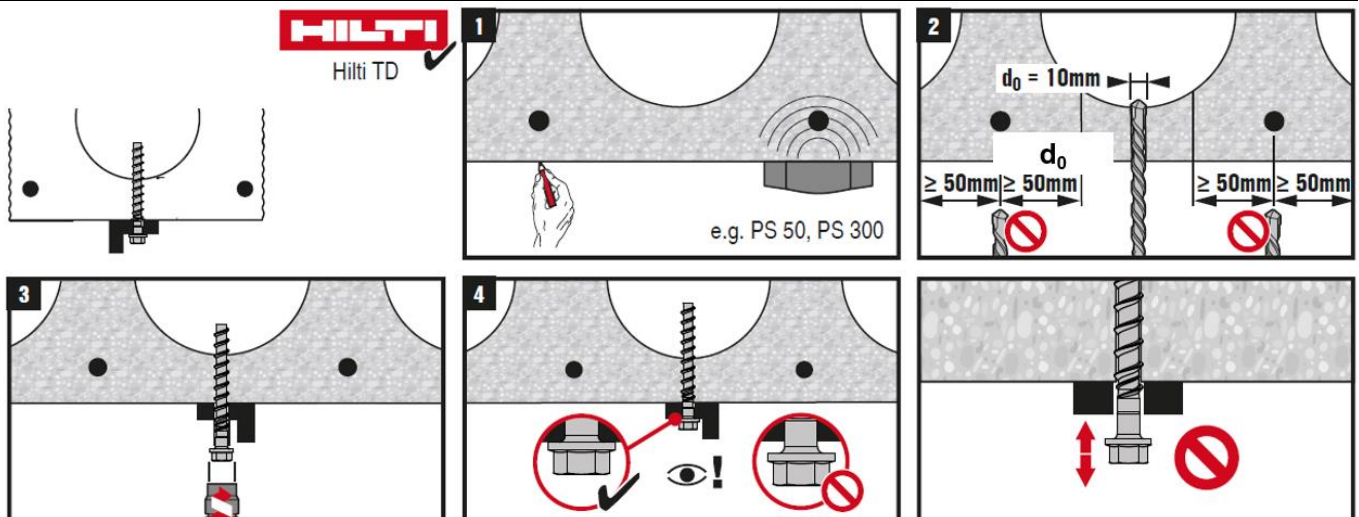

**Basic loading data for single anchor in pre-stressed Hollow core slab (HCS) for temporary fastening**
**All data in this section applies to**

- Correct setting (see setting instruction)
- Verification of wear of the screw with HUS HRG check gauge is needed

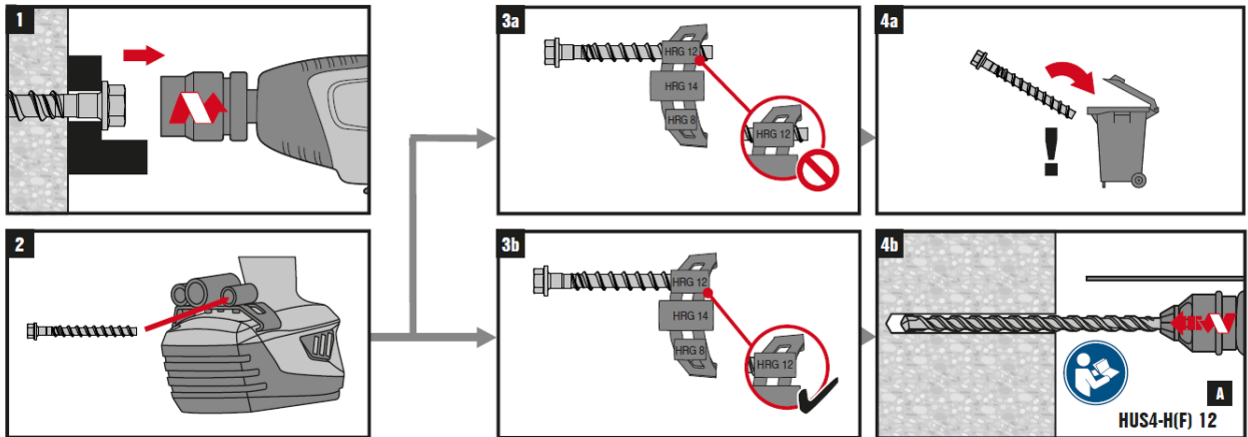

- No edge distance and spacing influence
- Ratio core width / web thickness  $w/e \leq 5,3$
- Concrete C30/37 to C50/60, uncracked

**Installation position for temporary fastening in HCS:**

- Top position of the slab is allowed.
- Anchor to be installed within position of  $\pm 10$  mm of the thickest section of the solid part.

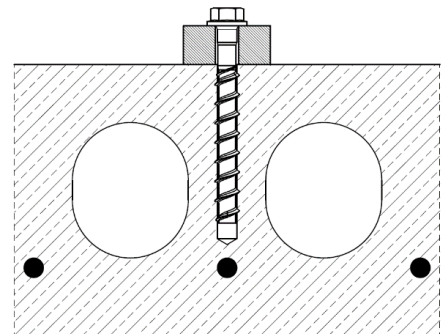

Anchor size		10	12	14
Nominal embedment depth	$h_{nom}$ [mm]	55 / 75 / 85	60 / 80 / 100	65 / 85 / 115
Drill hole depth	$h_1 \geq$ [mm]	$h_{nom} + 10$ mm		

**Characteristic resistance: Concrete C30/37**

Anchor size			10			12			14		
Type			A, AF, C, H, HF			H			A, AF, H, HF		
Nom. embedment depth	$h_{nom}$	[mm]	55	75	85	60	80	100	65	85	115
Tension	$N_{Rk}$	[kN]	14,3	22,1	23,6	16,9	24,0	30,1	18,2	26,5	37,6
Shear	$V_{Rk}$	[kN]	15,0	25,1	26,4	23,3	28,3	33,3	25,5	31,4	37,0

**Design resistance: Concrete C30/37**

Anchor size			10			12			14		
Type			A, AF, C, H, HF			H			A, AF, H, HF		
Nom. embedment depth	$h_{nom}$	[mm]	55	75	85	60	80	100	65	85	115
Tension	$N_{Rd}$	[kN]	9,6	14,7	15,8	11,2	16,0	20,1	12,1	17,7	25,1
Shear	$V_{Rd}$	[kN]	10,0	16,7	17,6	15,5	18,8	22,2	17,0	20,9	24,7

**Recommended load: Concrete C30/37**

Anchor size			10			12			14		
Type			A, AF, C, H, HF			H			A, AF, H, HF		
Nom. embedment depth	$h_{nom}$	[mm]	55	75	85	60	80	100	65	85	115
Tension	$N_{Rec}$	[kN]	6,8	10,5	11,3	8,0	11,4	14,3	8,7	12,6	17,9
Shear	$V_{Rec}$	[kN]	7,2	12,0	12,6	11,1	13,5	15,9	12,1	15,0	17,6

With overall partial safety factor for action  $\gamma = 1,4$ . The partial safety factors for action depend on the type of loading and shall be taken from national regulations.



**Characteristic resistance: Concrete C45/55**

Anchor size			10			12			14		
Type	HUS4		A, AF, C, H, HF			H			A, AF, H, HF		
Nom. embedment depth	$h_{nom}$	[mm]	55	75	85	60	80	100	65	85	115
Tension	$N_{Rk}$	[kN]	17,6	27,1	29,0	20,7	29,4	36,9	22,3	32,5	46,1
Shear	$V_{Rk}$	[kN]	18,4	25,1	26,4	23,3	28,3	33,3	25,9	31,4	37,0

**Design resistance: Concrete C45/55**

Anchor size			10			12			14		
Type	HUS4		A, AF, C, H, HF			H			A, AF, H, HF		
Nom. embedment depth	$h_{nom}$	[mm]	55	75	85	60	80	100	65	85	115
Tension	$N_{Rd}$	[kN]	11,7	18,1	19,3	13,8	19,6	24,6	14,9	21,7	30,7
Shear	$V_{Rd}$	[kN]	12,3	16,7	17,6	15,5	18,8	22,2	17,3	20,9	24,7

**Recommended load: Concrete C45/55**

Anchor size			10			12			14		
Type	HUS4		A, AF, C, H, HF			H			A, AF, H, HF		
Nom. embedment depth	$h_{nom}$	[mm]	55	75	85	60	80	100	65	85	115
Tension	$N_{Rec}$	[kN]	8,4	12,9	13,8	9,8	14,0	17,6	10,6	15,5	21,9
Shear	$V_{Rec}$	[kN]	8,8	12,0	12,6	11,1	13,5	15,9	12,3	15,0	17,6

With overall partial safety factor for action  $\gamma = 1,4$ . The partial safety factors for action depend on the type of loading and shall be taken from national regulations.

**Anchor spacing and edge distance**



Anchor size			10			12			14		
Type	HUS4		A, AF, C, H, HF			H			A, AF, H, HF		
Minimum spacing	$s_{min}$	[mm]	40			50			60		
Characteristic spacing	$s_{cr}$	[mm]	$3 * h_{ef}$								
Minimum edge distance	$c_{min}$	[mm]	40			50			60		
Characteristic edge distance	$c_{cr}$	[mm]	$1,5 * h_{ef}$								

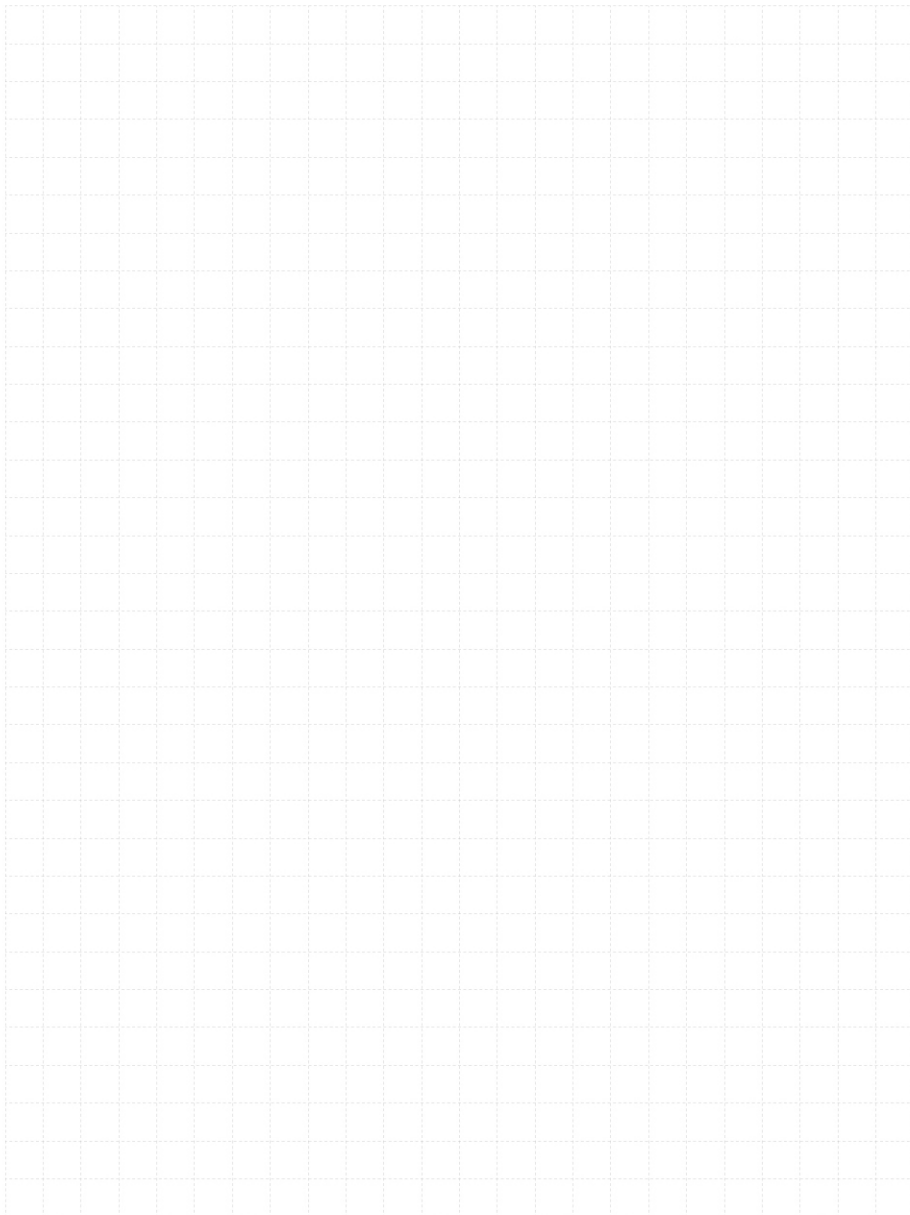







### 3.2.2 HUS4-HR/ HUS4-CR

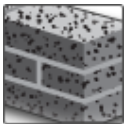
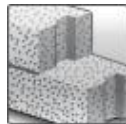
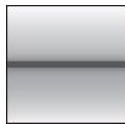

# HUS4-HR / HUS4-CR Screw anchor

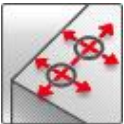
Ultimate performance screw anchor for single point fastening

Anchor version	Benefits
 <p>HUS4-HR (6-14)*</p>	<ul style="list-style-type: none"> <li>- High productivity - less drilling and fewer operations than with conventional anchors</li> <li>- ETA approval for cracked and non-cracked concrete</li> <li>- ETA approval for Seismic C1</li> <li>- Smaller edge and spacing distance</li> <li>- Three embedment depths for maximum design flexibility and flexible design for concrete cone capacity</li> <li>- No cleaning required size 6 to 14</li> <li>- Through fastening with H and C head</li> </ul>
 <p>HUS4-CR (6-10)</p>	

Base material	Load conditions
 <p>Concrete (non-cracked)</p>	 <p>Concrete (cracked)</p>
 <p>Solid brick</p>	 <p>Autoclaved aerated concrete</p>
 <p>Static / quasi-static</p>	 <p>Seismic ETA-C1</p>
 <p>Fire resistance</p>	
Installation conditions	Other information
 <p>Small edge distance and spacing</p>	 <p>European Technical Assessment</p>
	 <p>CE conformity</p>
	 <p>PROFIS Engineering design software</p>
	 <p>Corrosion resistance</p>

## Approvals / certificates

Description	Authority	No. / date of issue
European Technical Assessment	DIBt	ETA-20/0867 / 14-07-2022
Fire test report	DIBt	ETA-20/0867 / 14-07-2022

\*HUS4-HR not available in size 12

**Static and quasi-static resistance (for a single anchor)**
**All data in this section applies to:**

- Correct setting (See setting instruction)
- No edge distance and spacing influence
- Steel failure
- Minimum base material thickness
- Concrete C 20/25,  $f_{ck,cube} = 25 \text{ N/mm}^2$

**Anchorage depth**

Anchor size		6	8			10			14		
Type	HUS4	HR, CR	HR, CR			HR, CR			HR		
Nominal embedment depth	$h_{nom}$ [mm]	55	50 <sup>a)</sup>	60	80	60 <sup>a)</sup>	70	90	-	70	110

a) Hilti Technical Data for embedment depth

**Characteristic resistance**

Anchor size		6	8			10			14		
Type	HUS4	HR, CR	HR, CR			HR, CR			HR		
<b>Non-cracked concrete</b>											
Tension	$N_{Rk}$ [kN]	9,0	9,0 <sup>a)</sup>	12,0	16,0	12,0 <sup>a)</sup>	16,0	25,0	-	18,4	39,2
Shear	$V_{Rk}$ [kN]	17,0	23,0 <sup>a)</sup>	26,0	26,0	30,7 <sup>a)</sup>	33,0	33,0	-	36,9	77,0
<b>Cracked concrete</b>											
Tension	$N_{Rk}$ [kN]	5,0	5,0 <sup>a)</sup>	8,5	15,0	7,5 <sup>a)</sup>	12,0	16,0	-	12,0	25,0
Shear	$V_{Rk}$ [kN]	15,6	16,1 <sup>a)</sup>	22,2	26,0	21,5 <sup>a)</sup>	27,3	33,0	-	25,8	54,9

a) Hilti Technical Data

**Design resistance**

Anchor size		6	8			10			14		
Type	HUS4	HR, CR	HR, CR			HR, CR			HR		
<b>Non-cracked concrete</b>											
Tension	$N_{Rd}$ [kN]	4,3	5,0 <sup>a)</sup>	8,0	8,9	6,7 <sup>a)</sup>	8,9	16,7	-	10,2	21,8
Shear	$V_{Rd}$ [kN]	11,3	15,4 <sup>a)</sup>	17,3	17,3	20,5 <sup>a)</sup>	22,0	22,0	-	24,6	51,3
<b>Cracked concrete</b>											
Tension	$N_{Rd}$ [kN]	2,4	2,8 <sup>a)</sup>	5,7	8,3	4,2 <sup>a)</sup>	6,7	10,7	-	6,7	13,9
Shear	$V_{Rd}$ [kN]	10,4	10,8 <sup>a)</sup>	14,8	17,3	14,3 <sup>a)</sup>	18,2	22,0	-	17,2	36,6

a) Hilti Technical Data

**Recommended loads<sup>b)</sup>**

Anchor size		6	8			10			14		
Type	HUS4	HR, CR	HR, CR			HR, CR			HR		
<b>Non-cracked concrete</b>											
Tension	$N_{Rec}$ [kN]	3,1	3,6 <sup>a)</sup>	5,7	6,3	4,8 <sup>a)</sup>	6,3	11,9	-	7,3	15,6
Shear	$V_{Rec}$ [kN]	8,1	11,0 <sup>a)</sup>	12,4	12,4	14,6 <sup>a)</sup>	15,7	15,7	-	17,6	36,7
<b>Cracked concrete</b>											
Tension	$N_{Rec}$ [kN]	1,7	2,0 <sup>a)</sup>	4,0	6,0	3,0 <sup>a)</sup>	4,8	7,6	-	4,8	9,9
Shear	$V_{Rec}$ [kN]	7,4	7,7 <sup>a)</sup>	10,6	12,4	10,2 <sup>a)</sup>	13,0	15,7	-	12,3	26,2

a) Hilti Technical Data

 b) With overall partial safety factor for action  $\gamma = 1,4$ . The partial safety factors for action depend on the type of loading and shall be taken from national regulations.

## Seismic resistance

### All data in this section applies to:

- Correct setting (See setting instruction)
- No edge distance and spacing influence
- Steel failure
- Minimum base material thickness
- Concrete C 20/25,  $f_{ck,cube} = 25 \text{ N/mm}^2$

### Anchorage depth

Anchor size			8	10	14
Type	HUS4-		HR, CR	HR, CR	HR, CR
Nominal anchorage depth	$h_{nom}$	[mm]	80	90	110

### Characteristic resistance in case of seismic performance category C1

Anchor size			8	10	14
Type	HUS4-		HR	HR	HR
<b>with Hilti filling set</b>					
Tension	$N_{Rk,seis}$	[kN]	7,7	12,5	17,5
Shear	$V_{Rk,seis}$		11,1	17,9	46,7
Type	HUS4-		HR, CR	HR, CR	HR, CR
<b>without Hilti filling set</b>					
Tension	$N_{Rk,seis}$	[kN]	7,7	12,5	17,5
Shear	$V_{Rk,seis}$		5,6	9,0	23,3

### Design resistance in case of seismic performance category C1

Anchor size			8	10	14
Type	HUS4-		HR	HR	HR
<b>with Hilti filling set</b>					
Tension	$N_{Rd,seis}$	[kN]	4,3	8,3	9,7
Shear	$V_{Rd,seis}$		7,4	11,9	31,1
Type	HUS4-		HR, CR	HR, CR	HR, CR
<b>without Hilti filling set</b>					
Tension	$N_{Rd,seis}$	[kN]	4,3	8,3	9,7
Shear	$V_{Rd,seis}$		3,7	6,0	15,6

## Fire resistance

### All data in this section applies to:

- Correct setting (See setting instruction)
- No edge distance and spacing influence
- Steel failure
- Minimum base material thickness
- Concrete C 20/25,  $f_{ck,cube} = 25 \text{ N/mm}^2$
- Partial safety factor for resistance under fire exposure  $\gamma_{M,fi}=1,0$  (in absence of other national regulations)
- For more fire resistance data please see ETA-20/0867.

### Anchorage depth

Anchor size		6		8				10				14	
Type	HUS4-	HR	CR	HR	CR	HR	CR	HR	CR	HR	CR	HR	
Nominal anchorage depth	$h_{nom}$ [mm]	55	55	60	80	60	80	70	90	70	90	70	110

### Characteristic resistance

Anchor size		6		8				10				14	
Type	HUS4-	HR	CR	HR	CR	HR	CR	HR	CR	HR	CR	HR	
<b>Fire Exposure R30</b>													
Tension	$N_{Rk}$ [kN]	1,3	0,2	1,5	3,0	0,8	0,8	2,3	4,0	1,4	1,4	3,0	6,3
Shear	$V_{Rk}$ [kN]	3,5	0,2	5,2	9,3	0,8	0,8	7,4	14,6	1,4	1,4	6,7	23,6
<b>Fire Exposure R120</b>													
Tension	$N_{Rk}$ [kN]	1,0	0,1	1,2	1,7	0,4	0,4	1,8	2,4	0,8	0,8	2,4	5,0
Shear	$V_{Rk}$ [kN]	1,0	0,1	1,7	1,7	0,4	0,4	2,4	2,4	0,8	0,8	5,4	5,4

### Design resistance

Anchor size		6		8				10				14	
Type	HUS4-	HR	CR	HR	CR	HR	CR	HR	CR	HR	CR	HR	
<b>Fire Exposure R30</b>													
Tension	$N_{Rd}$ [kN]	1,3	0,2	1,5	3,0	0,8	0,8	2,3	4,0	1,4	1,4	3,0	6,3
Shear	$V_{Rd}$ [kN]	3,5	0,2	5,2	9,3	0,8	0,8	7,4	14,6	1,4	1,4	6,7	23,6
<b>Fire Exposure R120</b>													
Tension	$N_{Rd}$ [kN]	1,0	0,1	1,2	1,7	0,4	0,4	1,8	2,4	0,8	0,8	2,4	5,0
Shear	$V_{Rd}$ [kN]	1,0	0,1	1,7	1,7	0,4	0,4	2,4	2,4	0,8	0,8	5,4	5,4



**Materials**
**Mechanical properties**

Anchor size		6	8	10	14
Type	HUS4-	HR, CR	HR, CR	HR, CR	HR
Nominal tensile strength	$f_{uk}$ [N/mm <sup>2</sup> ]	1050	870	950	690
Yield strength	$f_{yk}$ [N/mm <sup>2</sup> ]	900	745	815	590
Stressed cross-section	$A_s$ [mm <sup>2</sup> ]	22,9	39	55,4	143,1
Moment of resistance	$W$ [mm <sup>3</sup> ]	15	34	58	255
Characteristic bending resistance	$M^{0}_{Rk,s}$ [Nm]	19	36	66	193

**Material quality**

Part	Material
Hexagonal head concrete screw	Stainless steel (grade A4)
Countersunk head concrete screw	Stainless steel (grade A4)

**Head configuration**

Type	Part	
HUS4-HR	Hexagonal head	
HUS4-CR	Countersunk head	

**Fastener dimensions**

Anchor size		6	8	10	14
Type	HUS4-	HR	HR	HR	HR
Outer diameter of the screw thread	$d_t$ [mm]	7,55	10,05	12,25	16,56
Diameter of integrated	$d_i$ [mm]	17,00	17,50	20,50	30,00
Length of the screw (min/max)	$L$ [mm]	60/70	65/105	75/130	80/135

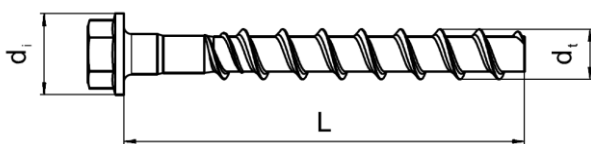

**HUS4:** Hilti Universal Screw 4<sup>th</sup> generation

**HR:** Hexagonal head, stainless steel

**10:** Nominal screw diameter

**100:** total length of the screw

Anchor size		6	8	10
Type	HUS4-	CR	CR	CR
Outer diameter of the screw thread	$d_t$ [mm]	7,55	10,05	12,25
Countersunk head diameter	$d_h$ [mm]	17,50	18,00	21,00
Length of the screw (min/max)	$L$ [mm]	60/70	65/95	75/105

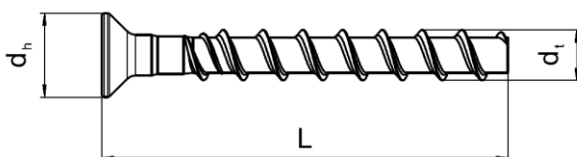

**HUS4:** Hilti Universal Screw 4<sup>th</sup> generation

**HR:** Hexagonal head, stainless steel

**CR:** Countersunk head, stainless steel

**10:** Nominal screw diameter

**100:** total length of the screw

**Setting information**
**Setting details**

Anchor size			6	8			10			14		
Type	HUS-	HR, CR	HR, CR <sup>a)</sup>			HR, CR <sup>a)</sup>			HR			
Nominal embedment depth	$h_{nom}$	[mm]	55	50	60	80	60	70	90	70	110	
Effective anchorage depth	$h_{ef}$	[mm]	45	38	47	64	46	54	71	52	86	
Nominal diameter of drill bit	$d_0$	[mm]	6	8			10			14		
Cutting diameter of drill bit	$d_{cut}$	[mm]	6,4	8,45			10,45			14,5		
Clearance hole diameter	$d_f$	[mm]	9	12			14			18		
Depth drill hole (cleaning)	$h_1$	[mm]	65	60	70	90	70	80	100	80	120	
Depth drill hole (no cleaning)	$h_1$	[mm]	77	76	86	106	90	100	120	108	148	
Wrench size	SW	[mm]	13	13			15			21		
Diameter of countersunk	$d_h$	[mm]	11	18			21			-		
Installation torque	Concrete	$T_{inst}$	[Nm]	-a)	35	-a)	-a)	45 <sup>c)</sup>			65	
	Solid m, Mz 12	$T_{inst}$	[Nm]	10	- b)	16	16	- b)	20	20	- b)	- b)
	Solid m, KS 12	$T_{inst}$	[Nm]	10	- b)	16	16	- b)	20	20	- b)	- b)
	Aerated concrete	$T_{inst}$	[Nm]	4	- b)	8	8	- b)	10	10	- b)	- b)

a) Hand setting in concrete base material not allowed (machine setting only)

b) Hilti does not recommend this setting process for this application.

c) Installation torque refer to HUS4-HR only

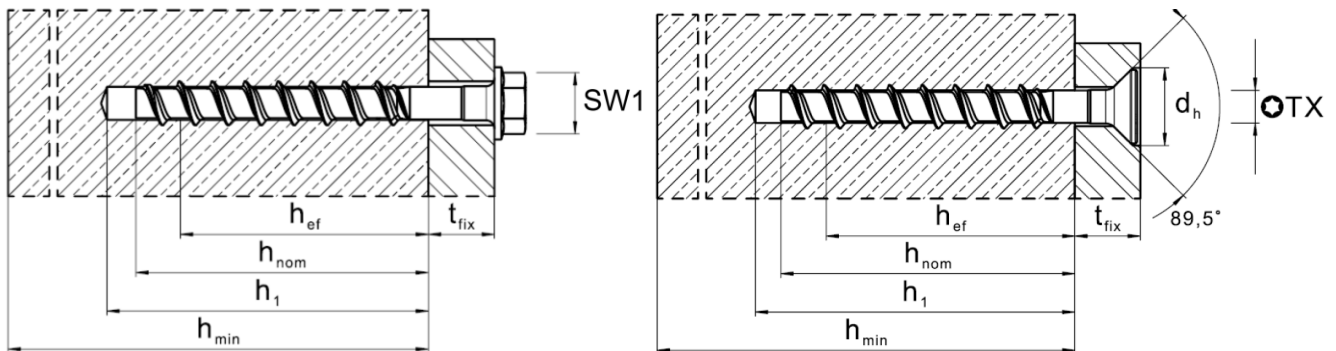



**Installation equipment**

Anchor size	6	8	10	14
Type	HUS4- HR, CR	HR, CR	HR, CR	HR
Rotary hammer	TE 2 – TE 30			
Drill bit	TE-CX4 (SDS PLUS) 6/17	TE-CX4 (SDS PLUS) 8/17	TE-CX4 (SDS PLUS) 10/22	TE-CX4 (SDS PLUS) 14/22
Socket wrench insert	SI-S 13 1/2" (S)	SI-S 13 1/2" (S) S-NSD 13 1/2" (L)	SI-S 13 1/2" (S)	SI-S 13 1/2" (S)
Torx (CR type only)	-	S-SY TX 45	S-SY TX 50	-
Impact screw driver <sup>1)</sup>	SIW 6AT-A22 1/2" SIW 4AT-A22 1/2" h <sub>nom1</sub> – gr.1 h <sub>nom2</sub> – gr.2 h <sub>nom3</sub> – gr.3	SIW 6AT-A22 1/2" SIW 4AT-A22 1/2" SIW22T-A 1/2", 3/4" (L=55&65mm – long socket) SIW6-22 gr.2 1/2" (L=55&65mm – long socket)	SIW 6AT-A22 1/2" SIW 4AT-A22 1/2" SIW22T-A 1/2", 3/4" SIW6-22 gr.2 1/2"	SIW22T-A 1/2" SIW6-22 gr.2 1/2" SIW8-22 gr.1 1/2" SIW9-22 3/4"

<sup>1)</sup> Installation with other impact screw driver of equivalent power is possible.

**Setting parameters**

Anchor size	6	8	10	14
Type	HUS- HR, CR	HR, CR <sup>a)</sup>	HR, CR <sup>a)</sup>	HR
Nominal anchorage depth	h <sub>nom</sub> [mm]	55	50 60 80	60 70 90 70 110
Minimum base material thickness	h <sub>min</sub> [mm]	100	100 100 120	120 120 140 140 160
Minimum spacing	s <sub>min</sub> [mm]	35	45 45 50	50 50 50 50 60
Minimum edge distance	c <sub>min</sub> [mm]	35	45 45 50	50 50 50 50 60
Critical spacing for splitting failure	s <sub>cr,sp</sub> [mm]	135	114 114 192	166 194 256 187 310
Critical edge distance for splitting failure	c <sub>cr,sp</sub> [mm]	68	57 71 96	83 97 128 94 155
Critical spacing for concrete cone failure	s <sub>cr,N</sub> [mm]	135	114 114 192	166 194 256 187 310
Critical edge distance for concrete cone failure	c <sub>cr,N</sub> [mm]	68	57 71 96	83 97 128 94 155

For spacing (edge distance) smaller than critical spacing (critical edge distance) the design loads have to be reduced (see system design resistance).

Critical spacing and critical edge distance for splitting failure apply only for non-cracked concrete. For cracked concrete only the critical spacing and critical edge distance for concrete cone failure are decisive.

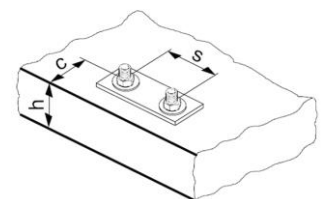

**Setting instructions**

\*For detailed information on installation see instruction for use given with the package of the product

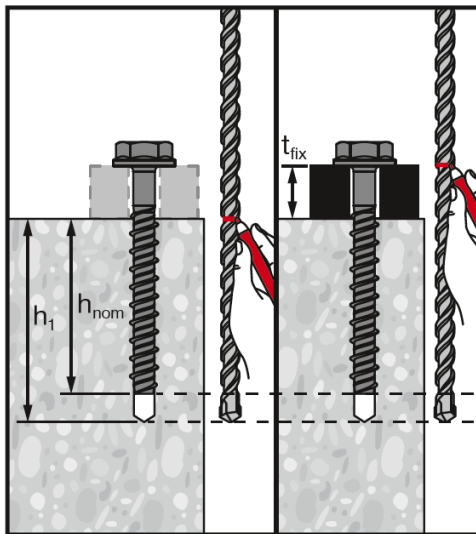
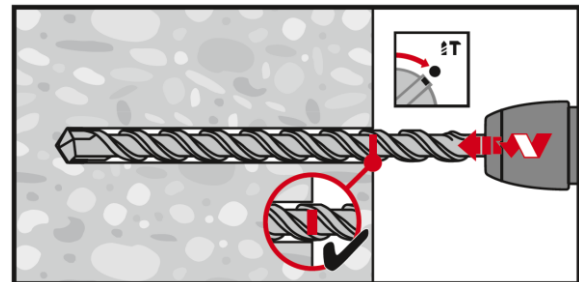
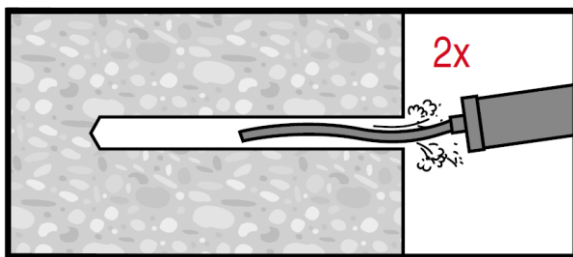
**Setting instruction**
**Mark drill-bit length:**

**1. Hammer drilling:**

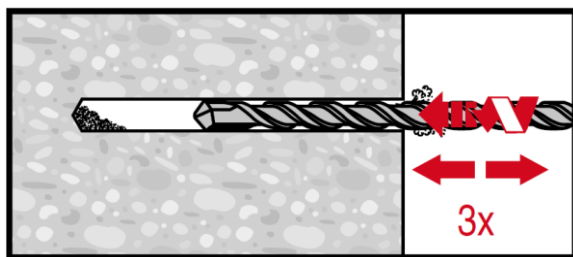
**2a. Cleaning:**

Cleaning needed in downward and horizontal installation direction with drill hole depth  $h_{nom} + 10\text{mm}$

**2b. Non-cleaning – 3x ventilation**

No cleaning is allowed in upward installation direction. No cleaning is allowed in downward and horizontal installation direction when 3x ventilation<sup>1)</sup> after drilling is executed.

Drill hole depth  $h_{nom} + 10\text{mm} + 2 * d_0$

<sup>1)</sup> moving the drill bit in and out of the drill hole 3 times after the recommended drilling depth  $h_1$  is achieved. This procedure shall be done with both revolution and hammer functions activated in the drilling machine. For more details read the relevant installation instruction (MPII).

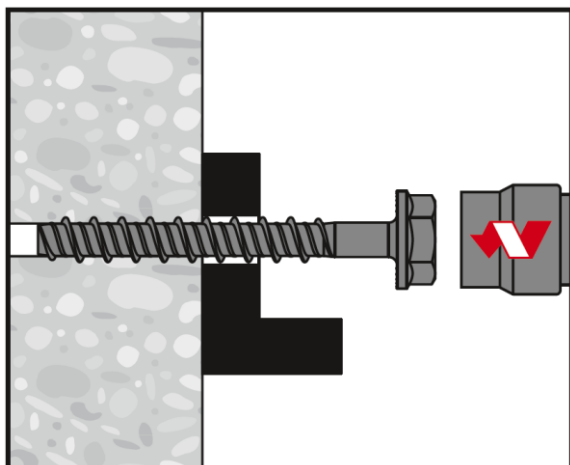
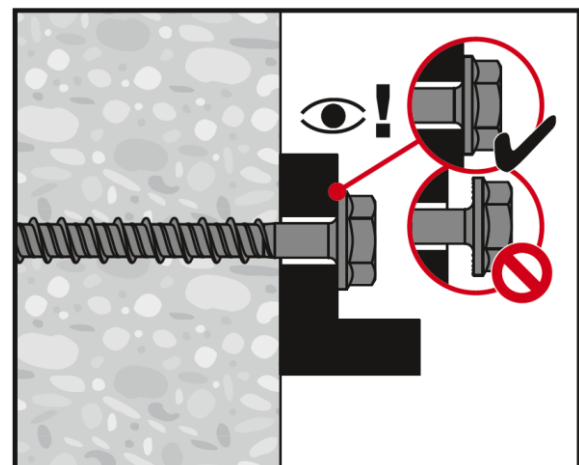
**3. Setting by impact screw driver**

**4. Setting check**

## Basic loading data (for a single anchor) in solid masonry units



### All data in this section applies to:

- Load values valid for holes drilled with TE rotary hammers in hammering mod
- Correct anchor setting (see instruction for use, setting details)
- The core/material ratio may not exceed 15 % of a bed joint area
- The brim area around holes must be at least 70mm
- Edge distances, spacing and other influences, see below
- All data given in this section according to Hilti Technical Data

### Nominal embedment depth

Anchor size		6	8	10
Type	HUS4-	HR	HR	HR, CR
Nominal embedment depth	$h_{nom}$ [mm]	55	60	70

### Recommended loads for HUS4-HR / HUS4-CR

Anchor size			6	8	10
	Solid clay brick Mz 12/2,0 DIN 105 / EN 771-1 $f_b^{a)} \geq 12 \text{ N/mm}^2$	Tension $N_{Rec}$ [kN]	0,9	1,0	1,1
		Shear $V_{Rec}$ [kN]	1,4	2,0	2,3
	Solid sand-lime brick Mz 12/2,0 DIN 106/EN 771-2 $f_b^{a)} \geq 12 \text{ N/mm}^2$	Tension $N_{Rec}$ [kN]	0,6	0,6	1,0
		Shear $V_{Rec}$ [kN]	0,9	1,1	1,7
	Aerated concrete PPW 6-0,4 DIN 4165/EN 771-4 $f_b^{a)} \geq 6 \text{ N/mm}^2$	Tension $N_{Rec}$ [kN]	0,2	0,2	0,4
		Shear $V_{Rec}$ [kN]	0,4	0,4	0,9

## Permissible anchor location in brick and block walls

### Edge distance and spacing influence

- The technical data for HUS4-HR anchors are reference loads for MZ 12 and KS 12. Due to the large variation of natural stone slid bricks, on site anchor testing is recommended to validate technical data
- The HUS4-HR anchor was installed and tested in center of solid bricks as shown. The HUS4-HR anchor was not tested in the mortar joint between solid bricks or in hollow bricks, however a load reduction is expected
- For brick walls where anchor position in brick can not be determined, 100 % anchor testing is recommended
- Distance to free edge free edge to solid masonry (Mz and KS) units  $\geq 170\text{mm}$
- Distance to free edge free edge to solid masonry (autoclaved aerated gas concrete) units  $\geq 170\text{mm}$
- The minimum distance to horizontal and vertical mortar joint ( $c_{min}$ ) is started in drawing below
- Minimum anchor spacing ( $s_{min}$ ) in one brick/block is  $\geq 2 \cdot c_{min}$

### Limits

- Applied load to individual bricks may not exceed 1,0 kN without compression or 1,4 kN with compression
- All data is for multiple use for non-structural applications
- Plaster, graveling, lining or levelling courses are regarded as non-bearing and may not be taken into account for the calculation of embedment depth

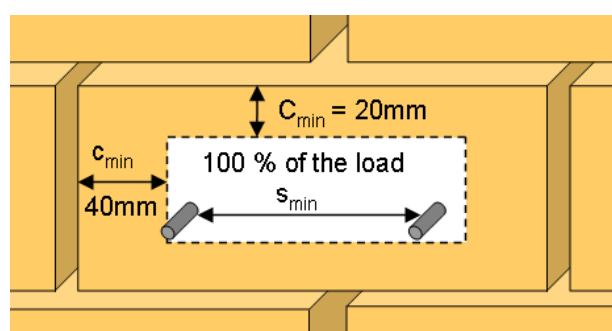



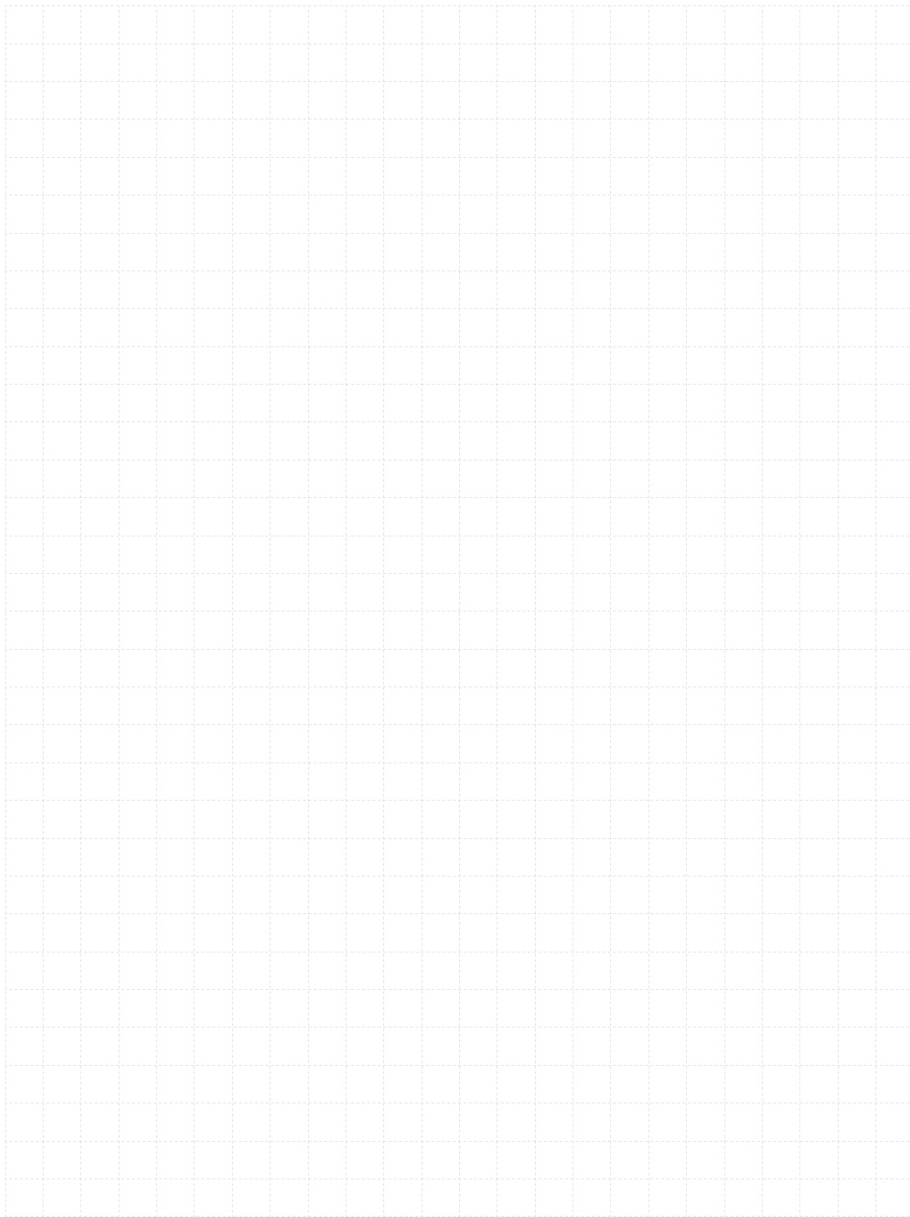











### 3.2.3 HUS3 H



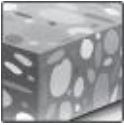

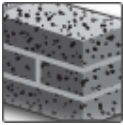

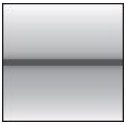
# HUS3 Screw anchor

## Ultimate performance screw anchor for single point fastening

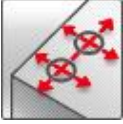
Anchor version		Benefits
	HUS3-H (6-14)	- High productivity - less drilling and fewer operations than with conventional anchors
	HUS3-HF (8-14)	- ETA approval for cracked and non-cracked concrete - ETA approval for Seismic C1 and C2
	HUS3-C (8-10)	- ETA approval for adjustability (unscrew-rescrew) - High loads
	HUS3-A (6)	- Small edge and spacing distance
	HUS3-P (6)	- abZ (DIBt) approval for reusability in fresh concrete ( $f_{ck, cube} = 10/15/20 \text{ Nmm}^2$ ) for temporary applications
	HUS3-PL (6)	- Three embedment depths for maximum design flexibility - No cleaning required
	HUS3-PS (6)	- HUS3-HF with multilayer coatings for additional corrosion protection
	HUS3-I (6)	- Forged-on washer and hexagon head with no protruding thread - Through fastening
	HUS3-I Flex (6)	

Base material				Load conditions		
						
Concrete (non-cracked)	Concrete (cracked)	Solid brick	Autoclaved aerated concrete	Static / quasi-static	Seismic ETA-C1,C2	Fire resistance

Installation conditions	Other information			
				
Small edge distance and spacing	European Technical Assessment	CE conformity	PROFIS Engineering design software	DIBt Approval Reusability

### Approvals / certificates

Description	Authority / Laboratory	No. / date of issue
European Technical Assessment	DIBt, Berlin	ETA-13/1038 / 28-07-2020
Fire test report	DIBt, Berlin	ETA-13/1038 / 28-07-2020

a) All data given in this section according ETA-13/1038 issue 22-07-2019.

**Static and quasi-static loading data (for a single anchor)**
**All data in this section applies to:**

- Correct setting (See setting instruction)
- No edge distance and spacing influence
- Steel failure
- Minimum base material thickness
- Concrete C 20/25,  $f_{ck} = 20 \text{ N/mm}^2$
- Hilti technical data calculated acc. to EN 1992-4

**Anchorage depth**

Anchor size	6				8			10			14			
Type	HUS3-	H, C, A, I, I-Flex	P, PS, PL	H, C, A, I, I-Flex	P, PS, PL	H, C, HF			H, C, HF			H, HF		
Nominal embedment depth $h_{nom}$ [mm]		$h_{nom1}$		$h_{nom2}$		$h_{nom1}$	$h_{nom2}$	$h_{nom3}$	$h_{nom1}$	$h_{nom2}$	$h_{nom3}$	$h_{nom1}$	$h_{nom2}$	$h_{nom3}$
		40		55		50	60	70	55	75	85	65	85	115

**Characteristic resistance**

Anchor size	6				8			10			14			
Type	HUS3-	H, C, A, I, I-Flex	P, PS, PL	H, C, A, I, I-Flex	P, PS, PL	H, C, HF			H, C, HF			H, HF		
<b>Non-cracked concrete</b>														
Tension	$N_{Rk}$ [kN]	7,0	7,0	9,0	7,5	9,0	12,0	16,0	12,0	20,0	27,0	17,0	26,6	43,3
Shear	$V_{Rk}$ [kN]	8,1	8,1	12,5	12,5	12,4	19,0	22,0	13,2	30,0	34,0	34,1	53,1	62,0
<b>Cracked concrete</b>														
Tension	$N_{Rk}$ [kN]	2,5	2,5	6,0	6,0	6,0	9,0	12,0	9,0	15,0	18,9	11,9	18,6	30,0
Shear	$V_{Rk}$ [kN]	5,7	5,7	12,5	12,5	8,7	19,0	22,0	9,2	30,0	34,0	23,8	37,2	60,6

**Design resistance**

Anchor size	6				8			10			14			
Type	HUS3-	H, C, A, I, I-Flex	P, PS, PL	H, C, A, I, I-Flex	P, PS, PL	H, C, HF			H, C, HF			H, HF		
<b>Non-cracked concrete</b>														
Tension	$N_{Rd}$ [kN]	3,9	3,9	5,0	4,2	6,0	8,0	10,7	8,0	13,3	18,0	11,4	17,7	28,8
Shear	$V_{Rd}$ [kN]	5,4	5,4	8,3	8,3	8,3	12,7	14,7	8,8	20,0	22,7	22,7	35,4	41,3
<b>Cracked concrete</b>														
Tension	$N_{Rd}$ [kN]	1,4	1,4	3,3	3,3	4,0	6,0	8,0	6,0	10,0	12,6	7,9	12,4	20,0
Shear	$V_{Rd}$ [kN]	3,8	3,8	8,3	8,3	5,8	12,7	14,7	6,2	20,0	22,7	15,9	24,8	40,4

**Recommended<sup>a)</sup> loads**

Anchor size	6				8			10			14			
Type	HUS3-	H, C, A, I, I-Flex	P, PS, PL	H, C, A, I, I-Flex	P, PS, PL	H, C, A			H, C, HF			H, HF		
<b>Non-cracked concrete</b>														
Tension	$N_{Rec}$ [kN]	2,8	2,8	3,6	3,0	4,3	5,7	7,6	5,7	9,5	12,9	8,1	12,6	20,6
Shear	$V_{Rec}$ [kN]	3,8	3,8	6,0	6,0	5,9	9,1	10,5	6,3	14,3	16,2	16,2	25,3	29,5
<b>Cracked concrete</b>														
Tension	$N_{Rec}$ [kN]	1,0	1,0	2,4	2,4	2,9	4,3	5,7	4,3	7,1	9,0	5,6	8,9	14,3
Shear	$V_{Rec}$ [kN]	2,7	2,7	6,0	6,0	4,1	9,1	10,5	4,4	14,3	16,2	11,4	17,7	28,9

a) With overall partial safety factor for action  $\gamma = 1,4$ . The partial safety factors for action depend on the type of loading and shall be taken from national regulations.

**Seismic loading data (for single anchor)**
**All data in this section applies to:**

- Correct setting (See setting instruction)
- No edge distance and spacing influence
- Steel failure
- Minimum base material thickness
- Concrete C 20/25,  $f_{ck,cube} = 25 \text{ N/mm}^2$
- $\alpha_{gap} = 1,0$  (using Hilti seismic filling set) or  $\alpha_{gap} = 0,5$  (without using Hilti seismic filling set) accordingly

**Anchorage depth for seismic C2**

Anchor size			8	10	14
Type			H,C,HF	H,C,HF	H,C,HF
Nominal embedment depth	$h_{nom}$	[mm]	$h_{nom3}$	$h_{nom3}$	$h_{nom3}$
			70	85	115
Effective anchorage depth	$h_{ef}$	[mm]	54,9	67,1	91,8

**Characteristic resistance in case of seismic performance category C2**

Anchor size			8	10	14
<b>with Hilti filling set (HUS3-H only)</b>					
Type			H	H	H
Tension	$N_{Rk,seis}$	[kN]	3,2	9,4	17,7
Shear	$V_{Rk,seis}$		14,7	25,6	46,5
<b>without Hilti filling set</b>					
Type			H,C,HF	H,C,HF	H,C,HF
Tension	$N_{Rk,seis}$	[kN]	3,2	9,4	17,7
Shear	$V_{Rk,seis}$		5,4	8,9	17,2

**Design resistance in case of seismic performance category C2**

Anchor size			8	10	14
<b>with Hilti filling set (HUS3-H only)</b>					
Type			H	H	H
Tension	$N_{Rk,seis}$	[kN]	2,1	6,3	11,8
Shear	$V_{Rk,seis}$		9,8	17,1	31,1
<b>without Hilti filling set</b>					
Type			H,C,HF	H,C,HF	H,C,HF
Tension	$N_{Rk,seis}$	[kN]	2,1	6,3	11,8
Shear	$V_{Rk,seis}$		3,6	5,9	11,5

**Anchorage depth for seismic C1**

Anchor size		6		8		10		14	
Type	HUS3-	H, C, A, I, I-Flex, P, PS, PL		H,C,HF		H,C,HF		H,C,HF	
Nominal embedment depth	$h_{nom}$ [mm]	$h_{nom1}$	$h_{nom2}$	$h_{nom2}$	$h_{nom3}$	$h_{nom2}$	$h_{nom3}$	$h_{nom2}$	$h_{nom3}$
		40	55	60	70	75	85	85	115
Effective anchorage depth	$h_{ef}$ [mm]	30	42	46,4	54,9	58,6	67,1	66,3	91,8

**Characteristic resistance in case of seismic performance category C1**

Anchor size		6		8		10		14	
with Hilti filling set (HUS3-H only)									
Type	HUS3 -	H		H		H		H	
Tension	$N_{Rk,seis}$ [kN]	- a)	- a)	9,0	11,9	13,1	16,1	15,8	25,7
Shear	$V_{Rk,seis}$	- a)	- a)	11,9	11,9	16,8	17,7	22,5	34,5
without Hilti filling set									
Type	HUS3 -	H, C, A, I, I-Flex, P, PS, PL		H, C, HF		H, C, HF		H, C, HF	
Tension	$N_{Rk,seis}$ [kN]	2,5	4,0	9,0	11,9	13,1	16,1	15,8	25,7
Shear	$V_{Rk,seis}$	2,4	2,4	6,0	6,0	8,4	8,9	11,3	17,3

a) Hilti filling set is not available for size 6

**Design resistance in case of seismic performance category C1**

Anchor size		6		8		10		14	
with Hilti filling set (HUS3-H only)									
Type	HUS3 -	H		H		H		H	
Tension	$N_{Rd,seis}$ [kN]	- a)	- a)	6,0	7,9	8,8	10,7	10,5	17,2
Shear	$V_{Rd,seis}$	- a)	- a)	7,9	7,9	11,2	11,8	15,0	23,0
without Hilti filling set									
Type	HUS3 -	H, C, A, I, I-Flex, P, PS, PL		H, C, HF		H, C, HF		H, C, HF	
Tension	$N_{Rd,seis}$ [kN]	1,4	2,2	6,0	7,9	8,8	10,7	10,5	17,2
Shear	$V_{Rd,seis}$	1,7	1,7	4,0	4,0	5,6	5,9	7,5	11,5

a) Hilti filling set is not available for size 6



## Fire resistance

### All data in this section applies to:

- Correct setting (see setting instruction)
- No edge distance and spacing influence
- Steel failure
- Minimum base material thickness
- For more fire resistance data please see the full ETA-13/1038 report.
- Partial safety factor for resistance under fire exposure  $\gamma_{M,fi}=1,0$  (in absence of other national regulations)

### Anchorage depth

Anchor size	6		8				10			14			
Type	HUS3-		H, C, A, I, I-Flex, P, PS, PL		H, H		C	H, HF		C	H, HF		
Nominal embedment depth $h_{nom}$ [mm]	$h_{nom1}$	$h_{nom2}$	$h_{nom1}$	$h_{nom2}$	$h_{nom3}$	$h_{nom1-3}$	$h_{nom1}$	$h_{nom2}$	$h_{nom3}$	$h_{nom1-3}$	$h_{nom1}$	$h_{nom2}$	$h_{nom3}$
	40	55	50	60	70	50-70	55	75	85	55-85	65	85	115

### Characteristic resistance

Anchor size	6		8				10			14				
Type	HUS3-		H, C, A, I, I-Flex, P, PS, PL		H, HF		C	H, HF		C	H, HF			
<b>Fire exposure R30</b>														
Tension	$N_{Rk,fi}$ [kN]	0,5	1,5	1,5	2,3	3,0	0,5	2,0	4,0	4,9	1,2	3,0	4,8	7,8
Shear	$V_{Rk,fi}$ [kN]	0,5	1,6	1,7	3,5	3,8	0,5	1,9	6,2	6,2	1,2	5,9	10,6	10,6
<b>Fire exposure R120</b>														
Tension	$N_{Rk,fi}$ [kN]	0,4	0,7	1,2	1,2	1,5	0,2	1,6	2,5	2,5	0,6	2,4	3,8	4,3
Shear	$V_{Rk,fi}$ [kN]	0,4	0,7	1,2	1,2	1,5	0,2	1,5	2,5	2,5	0,6	4,0	4,3	4,3

### Design resistance

Anchor size	6		8				10			14				
Type	HUS3-		H, C, A, I, I-Flex, P, PS, PL		H, H		C	H, HF		C	H, HF			
<b>Fire exposure R30</b>														
Tension	$N_{Rd,fi}$ [kN]	0,5	1,5	1,5	2,3	3,0	0,5	2,0	4,0	4,9	1,2	3,0	4,8	7,8
Shear	$V_{Rd,fi}$ [kN]	0,5	1,6	1,7	3,5	3,8	0,5	1,9	6,2	6,2	1,2	5,9	10,6	10,6
<b>Fire exposure R120</b>														
Tension	$N_{Rd,fi}$ [kN]	0,4	0,7	1,2	1,2	1,5	0,2	1,6	2,5	2,5	0,6	2,4	3,8	4,3
Shear	$V_{Rd,fi}$ [kN]	0,4	0,7	1,2	1,2	1,5	0,2	1,5	2,5	2,5	0,6	4,0	4,3	4,3

## Materials

### Mechanical properties

Anchor size		6	8	10	14
Type	HUS3-	H,C,A,I, I-flex,P,PS,PL	H,C,HF	H,C,HF	H,HF
Nominal tensile strength	$f_{uk}$ [N/mm <sup>2</sup> ]	930	810	805	730
Yield strength	$f_{yk}$ [N/mm <sup>2</sup> ]	745	695	690	630
Stressed cross-section	$A_s$ [mm <sup>2</sup> ]	26,9	48,4	77,0	131,7
Moment of resistance	$W$ [mm <sup>3</sup> ]	19,6	47	95	213
Characteristic bending resistance	$M^0_{Rk,s}$ [Nm]	21	46	92	187

### Material quality

Type	Material
HUS3 - H,A,C,P,PS, PL,I,I-Flex	Carbon steel, galvanized
HUS3 - HF	Carbon steel, multi-layer coating <sup>a)</sup>

a) Multi-layer coating provides a higher corrosion resistance compared to regular hot dip galvanized (HDG) systems with a 40µm coating thickness.

### Head configuration

Type	Part		
HUS3-H HUS3-HF	Hexagonal head		
HUS3-C	Countersunk head		
HUS3-A	External thread		
HUS3-P	Pan head		
HUS3-PS	Pan head (small)		
HUS3-PL	Pan head (large)		
HUS3-I	Internal thread		
HUS3-I Flex	External thread		

**Anchor dimensions**

Anchor size			6	8	10	14
Type	HUS3-		H,C,A,I, I-flex,P,PS,PL	H,C,HF	H,C,HF	H,HF
Threaded outer diameter	$d_t$	[mm]	7,85	10,30	12,40	16,85
Core diameter	$d_k$	[mm]	5,85	7,85	9,90	12,95
Shaft diameter	$d_s$	[mm]	6,15	8,45	10,55	13,80
Diameter of integrated washer	$d_i$	[mm]	16,50	17,50	20,50	29,0
Stressed section	$A_s$	[mm <sup>2</sup> ]	26,9	48,4	77,0	131,7

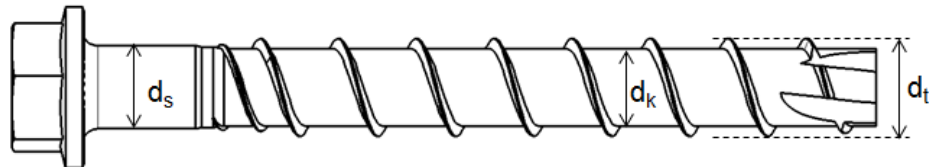

**HUS3:** Hilti Universal Screw 3<sup>rd</sup> generation

**H:** Hexagonal head

**10:** Screw diameter

**45/25/15:** Maximum thickness fixture  $t_{fix1}/t_{fix2}/t_{fix3}$  related to the embedment depth  $h_{nom1}/h_{nom2}/h_{nom3}$  (see Annex B3).

**Screw length and thickness of fixture for HUS3<sup>1)</sup>**

Anchor size		6											
Nominal embedment depth [mm]		$h_{nom1}$					$h_{nom2}$						
Type		40					55						
Thickness of fixture		H	C	A	I / I-Flex	P	PS / PL	H	C	A	I / I-Flex	P	PS / PL
		$t_{fix}$	$t_{fix}$	$t_{fix}$	$t_{fix}$	$t_{fix}$	$t_{fix}$	$t_{fix}$	$t_{fix}$	$t_{fix}$	$t_{fix}$	$t_{fix}$	$t_{fix}$
Length of screw [mm]	40	-	-	0	0	-	-	-	-	-	-	-	-
	45	5	5	5	5	5	5	-	-	-	-	-	-
	55	-	-	15	15	-	-	-	-	0	0	-	-
	60	20	20	-	-	20	20	5	5	-	-	5	5
	70	-	30	-	-	-	-	-	15	-	-	-	-
	80	40	-	-	-	45	-	25	-	-	-	25	-
	100	60	-	-	-	-	-	45	-	-	-	-	-
	120	80	-	-	-	-	-	65	-	-	-	-	-
	135	-	-	95	-	-	-	-	-	80	-	-	-
	155	-	-	115	-	-	-	-	-	100	-	-	-
	175	-	-	135	-	-	-	-	-	120	-	-	-
195	-	-	155	-	-	-	-	-	140	-	-	-	

1) Non-standard lengths, in the range  $55 \text{ mm} \leq L \leq 195 \text{ mm}$ , are also in the scope of ETA-13/1038.

**Screw length and thickness of fixture for HUS3-C<sup>1)</sup>**

Anchor size		8			10		
Nominal embedment depth [mm]		$h_{nom1}$	$h_{nom2}$	$h_{nom3}$	$h_{nom1}$	$h_{nom2}$	$h_{nom3}$
Thickness of fixture		50	60	70	55	75	85
		$t_{fix1}$	$t_{fix2}$	$t_{fix3}$	$t_{fix1}$	$t_{fix2}$	$t_{fix3}$
Length of screw [mm]	65	15	5	-	-	-	-
	70	-	-	-	15	-	-
	75	25	15	-	-	-	-
	85	35	25	15	-	-	-
	90	-	-	-	35	15	-
	100	-	-	-	45	25	15

1) Non-standard lengths, in the range  $65 \text{ mm} \leq L \leq 100 \text{ mm}$ , are also in the scope of ETA-13/1038.

**Screw length and thickness of fixture for HUS3-H and HUS3-HF<sup>1)</sup>**

Anchor size		8			10			14		
		$h_{nom1}$	$h_{nom2}$	$h_{nom3}$	$h_{nom1}$	$h_{nom2}$	$h_{nom3}$	$h_{nom1}$	$h_{nom2}$	$h_{nom3}$
Nominal embedment depth [mm]		50	60	70	55	75	85	65	85	115
Thickness of fixture		$t_{fix1}$	$t_{fix2}$	$t_{fix3}$	$t_{fix1}$	$t_{fix2}$	$t_{fix3}$	$t_{fix1}$	$t_{fix2}$	$t_{fix3}$
Length of screw [mm]	55	5	-	-	-	-	-	-	-	-
	60	-	-	-	5	-	-	-	-	-
	65	15	5	-	-	-	-	-	-	-
	70	-	-	-	15	-	-	-	-	-
	75	25	15	5	-	-	-	10	-	-
	80	-	-	-	25	5	-	-	-	-
	85	35	25	15	-	-	-	-	-	-
	90	-	-	-	35	15	5	-	-	-
	100	50	40	30	45	25	15	35	15	-
	110	-	-	-	55	35	25	-	-	-
	120	70	60	50	-	-	-	-	-	-
	130	-	-	-	75	55	45	65	45	15
150	100	90	80	95	75	65	85	65	35	

1) Non-standard lengths, in the range  $55 \text{ mm} \leq L \leq 150 \text{ mm}$ , are also in the scope of ETA-13/1038.

2) HUS3-HF available for size 14 with  $h_{nom1}$  and  $h_{nom2}$  only.

**Setting information**
**Setting details**

Anchor size		6					
Type	HUS3-	H	C	A	P, PS	I, I-Flex	PL
Nominal diameter of drill bit	$d_0$ [mm]	6					
Cutting diameter of drill bit	$d_{cut} \leq$ [mm]	6,4					
Clearance hole diameter	$d_f \leq$ [mm]	9					10
Wrench size	SW [mm]	13	-	13	-	13	-
Countersunk head diameter	$d_h$ [mm]	-	11,5	-			
Torx size	TX -	-	30	-	30	-	30
Depth of drill hole in floor/wall position	$h_1 \geq$ [mm]	$h_{nom} + 10 \text{ mm}$					
Depth of drill hole ceiling	$h_1 \geq$ [mm]	$h_{nom} + 3 \text{ mm}$					
Maximum Installation Torque	$T_{inst, max}$ [Nm]	25					

**Setting details**

Anchor size			8			10			14		
Type	HUS3-		H, HF, C			H, HF, C			H, HF		H
Nominal embedment depth	[mm]		$h_{nom1}$	$h_{nom2}$	$h_{nom3}$	$h_{nom1}$	$h_{nom2}$	$h_{nom3}$	$h_{nom1}$	$h_{nom2}$	$h_{nom3}$
			50	60	70	55	75	85	65	85	115
Nominal diameter of drill bit	$d_0$	[mm]	8			10			14		
Cutting diameter of drill bit	$d_{cut} \leq$	[mm]	8,45			10,45			14,50		
Clearance hole diameter	$d_f \leq$	[mm]	12			14			18		
Wrench size	SW	[mm]	13			15			21		
Countersunk head diameter	$d_h$	[mm]	18			21			-		
Torx size	TX	-	45			50			-		
Depth of drill hole in floor/wall position	$h_1 \geq$	[mm]	60	70	80	65	85	95	75	95	125
Depth of drill hole (with adjustability setting process)	$h_1 \geq$	[mm]	-	80	90	-	95	105	-		

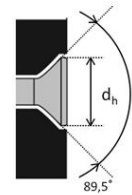
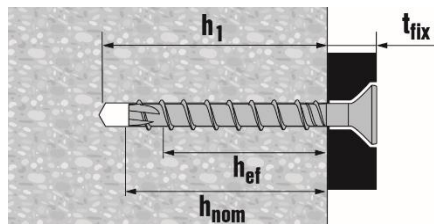
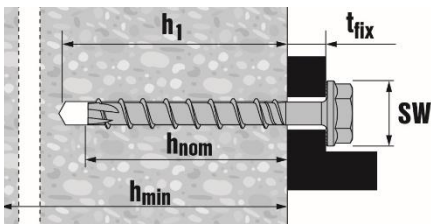
**Installation equipment**

Anchor size	6	8	10	14
Type	HUS3- H,C,A,I, I-flex,P,PS,PL	H,C,HF	H,C,HF	H,HF
Rotary hammer	TE 2 -TE 7	TE 2 – TE 30		
Drill bit for concrete, solid clay brick and solid sand-lime brick	CX 6	CX 8	CX 10	CX 14
Drill bit for aerated concrete	CX 5	CX 6	CX 8	-
Socket wrench insert	S-NSD 13 ½ L	SI-S ½" 13S	SI-S ½" 15S	SI-S ½" 21S
Torx	TX30	S-SY TX45	S-SY TX50	-
Tube for temporary application <sup>1)</sup>	-	HRG 8	HRG 10	HRG 14
Setting tool for cracked and un-cracked concrete	SIW 14 A SIW 22 A	SIW 14 A, SIW 22A, SIW 22 T-A	SIW 22 T-A SIW9	SIW 22 T-A SIW9
Setting tool for solid brick and aerated concrete	-	SFH 22 A		
Setting tool for hollow core slab	SIW 14 A SIW 22 A	SIW 22 A		

1) Only for HUS3-H

**Setting parameters**

Anchor size		6		8			10			14		
Type	HUS3-	H,C,A,I, I-flex,P,PS,PL		H,C,HF			H,C,HF			H,HF		
Nominal embedment depth	$h_{nom}$ [mm]	40	55	50	60	70	55	75	85	65	85	115
Minimum base material thickness	$h_{min}$ [mm]	80	100	100	100	120	100	130	140	120	160	200
Minimum spacing	$s_{min}$ [mm]	35		50	50	50	50	50	50	60	60	60
		35		40 $c \geq 50$								
Minimum edge distance	$c_{min}$ [mm]	35		40	40	40	50	50	50	60	60	60
Critical spacing for splitting failure	$s_{cr,sp}$ [mm]	120	126	120	140	170	130	180	220	170	200	280
Critical edge distance for splitting failure	$c_{cr,sp}$ [mm]	60	63	60	70	85	65	90	110	85	100	140
Critical spacing for concrete cone failure	$s_{cr,N}$ [mm]	$3 h_{ef}$										
Critical edge distance for concrete cone failure	$c_{cr,N}$ [mm]	$1,5 h_{ef}$										

For spacing (edge distance) smaller than critical spacing (critical edge distance) the design loads have to be reduced (see system design resistance).

Critical spacing and critical edge distance for splitting failure apply only for non-cracked concrete. For cracked concrete only the critical spacing and critical edge distance for concrete cone failure are decisive.

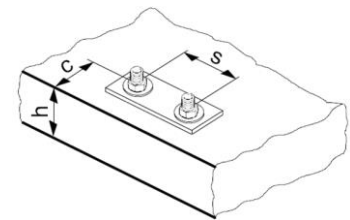

**Setting instructions**

\*For detailed information on installation see instruction for use given with the package of the product

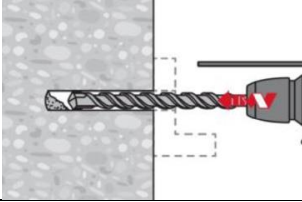
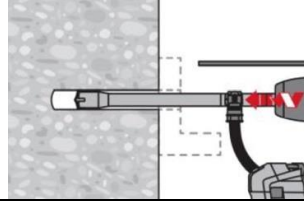
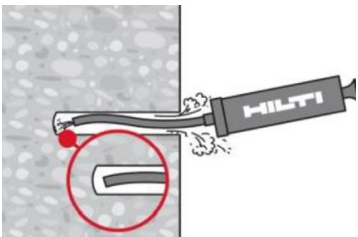
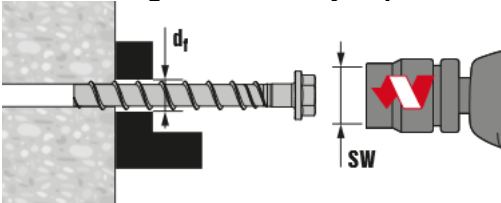
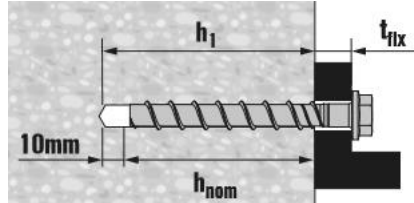
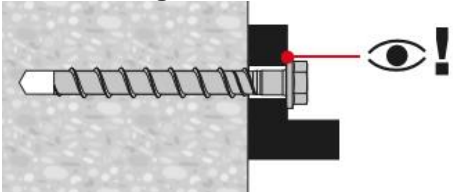
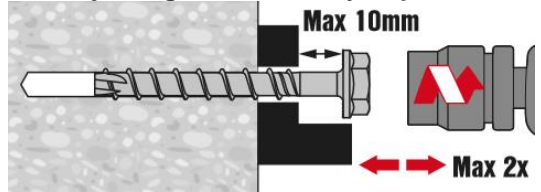
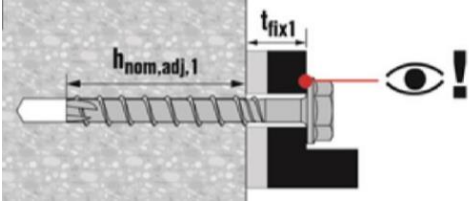
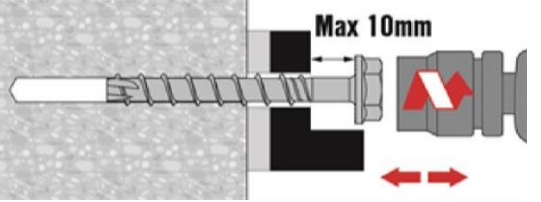
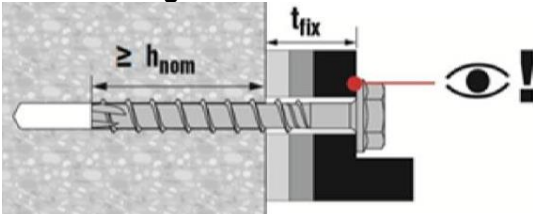
Setting instruction with adjustment	
<p><b>1a. Hammer drilling (HD):</b> Size 6 to 14</p> 	<p><b>1b. Hammer drilling with Hilti hollow drill bit (HDB):</b> Size 14 only. After drilling, proceed to fastener setting</p> 
<p><b>2. Cleaning</b></p> 	<p>Clean the drill hole. For sizes 6 and 8, hole cleaning is not required when 3x ventilation after drilling is executed and one of the following conditions is fulfilled:</p> <ul style="list-style-type: none"> <li>- drilling is in the vertical upwards orientation; or</li> <li>- drilling is in vertical downwards direction and the drilling depth is increased by additional <math>3 \cdot d_0</math>.</li> </ul> <p>For sizes 10 and 14, hole cleaning is not required when 3x ventilation after drilling is executed and one of the following conditions is fulfilled:</p> <ul style="list-style-type: none"> <li>- drilling is in the vertical upwards orientation; or</li> <li>- drilling is in vertical downwards or horizontal direction and the drilling depth is increased by additional <math>3 \cdot d_0</math>.</li> </ul> <p>1) moving the drill bit in and out of the drill hole 3 times after the recommended drilling depth <math>h_1</math> is achieved. This procedure shall be done with both revolution and hammer functions activated in the drilling machine. For more details read the relevant MPII.</p> <p>2) it should be verified that the thickness of the concrete member in which the fastener is installed observes the minimum distance between the drilling end and the opposite end of the member, fulfilling the relation <math>h &gt; h_1 + \Delta h</math> with <math>\Delta h = \max(2 \cdot d_0; 30 \text{ mm})</math>.</p>
<p><b>3. Inserting the anchor by impact screw driver</b></p> 	<p><b>4. Anchor installed</b></p> 
<p><b>5. Checking</b></p> 	<p><b>6. Adjusting the anchor by impact screw driver</b></p> 
<p><b>7. Checking</b></p> 	<p><b>8. Adjusting the anchor by impact screw driver</b></p> 
<p><b>9. Checking</b></p> 	

The anchor can be adjusted max. two times.

The total allowed thickness of shims added during the adjustment process is 10 mm.

The final embedment depth after adjustment process must be larger or equal than  $h_{nom2}$  or  $h_{nom3}$ .

For size 14 only, hole cleaning is not required under specific conditions. Check instructions for use for more information.

**Basic loading data for temporary application in standard and fresh concrete <28 days old,**  
 $f_{ck,cube} \geq 10 \text{ N/mm}^2$

**All data in this section applies to the following conditions:**

- Strength class,  $f_{ck,cube} \geq 10 \text{ N/mm}^2$
- Only temporary use
- Screw is reusable, before each usage it must be checked according to Hilti instruction for use with the suited tube Hilti HRG
- Design resistance and recommended loads are valid for single anchor only
- Design resistance as well as recommended loads are valid for all load directions and valid for both cracked and non-cracked concrete
- Minimum base material thickness
- No edge distance and spacing influence
- Valid for HUS3-H only
- All data in this section for sizes 10 and 14 according to DIBt approval Z-21.8.2018 issue 2014-04-01
- All data in this section for size 8 according to Hilti Technical Data

**Anchorage depth**

Technical data source		Hilti Technical data			DIBt approval Z-21.8-2018					
Anchor size	HUS3-H	8			10			14		
Nominal embedment depth	$h_{nom}$ [mm]	50	60	70	55	75	85	65	85	115

**Design resistance**

Technical data source		Hilti Technical data			DIBt approval Z-21.8-2018						
Anchor size	HUS3-H	8			10			14			
Tensile	$f_{ck,cube} \geq 10 \text{ N/mm}^2$	$N_{Rd}$	2,5	3,2	4,7	3,3	5,3	6,3	4,4	7,0	12,3
=	$f_{ck,cube} \geq 15 \text{ N/mm}^2$	= [kN]	3,1	4,0	5,7	4,0	6,4	7,8	5,4	8,5	15,0
Shear	$f_{ck,cube} \geq 20 \text{ N/mm}^2$	$V_{Rd}$	3,6	4,6	6,6	4,7	7,4	9,0	6,2	9,9	17,3

**Recommended load <sup>a)</sup>**

Technical data source		Hilti Technical data			DIBt approval Z-21.8-2018						
Anchor size	HUS3-H	8			10			14			
Tensile	$f_{ck,cube} \geq 10 \text{ N/mm}^2$	$N_{Rd}$	1,8	2,3	3,4	2,4	3,8	4,5	3,1	5,0	8,8
=	$f_{ck,cube} \geq 15 \text{ N/mm}^2$	= [kN]	2,2	2,9	4,1	2,9	4,6	5,5	3,8	6,1	10,7
Shear	$f_{ck,cube} \geq 20 \text{ N/mm}^2$	$V_{Rd}$	2,6	3,3	4,7	3,3	5,3	6,4	4,4	7,1	12,4

a) With overall partial safety factor for action  $\gamma = 1,4$ . The partial safety factors for action depend on the type of loading and shall be taken from national regulations.



**Setting information**
**Setting details**

Technical data source		Hilti			DIBt approval Z-21.8-2018					
Anchor size	HUS3-H	8			10			14		
Nominal anchorage depth	$h_{nom}$ [mm]	50	60	70	55	75	85	65	85	115
Minimum base material thickness	$h_{min}$ [mm]	100	115	145	115	150	175	130	175	255
Minimum spacing	$s_{min}$ [mm]	180	225	285	225	300	345	255	345	510
Minimum edge distance direction 1	$c_1$ [mm]	60	75	95	75	100	115	85	115	170
Minimum edge distance direction 2	$c_2$ [mm]	95	115	145	115	150	175	130	180	260

**Setting parameters**

Technical data source		Hilti			DIBt approval Z-21.8-2018					
Anchor size	HUS3-H	8			10			14		
Nominal anchorage depth	$h_{nom}$ [mm]	50	60	70	55	75	85	65	85	115
Nominal diameter of drill bit	$d_o$ [mm]	8			10			14		
Cutting diameter of drill bit	$d_{cut} \leq$ [mm]	8,45			10,45			14,50		
Depth of drill bit	$h_1 \leq$ [mm]	60	70	80	65	85	95	75	95	125
Diameter of clearance hole in the fixture	$d_f \leq$ [mm]	12			14			18		
Width across	SW [mm]	13			15			21		
Impact screw driver		Hilti SIW 22 T-A								
Suited tube		Hilti HRG 8			Hilti HRG 10			Hilti HRG 14		

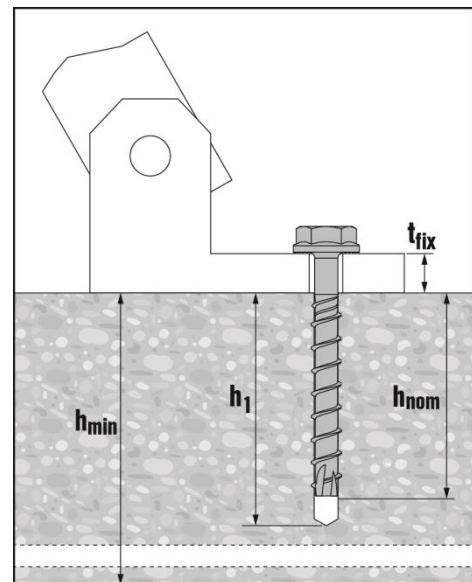
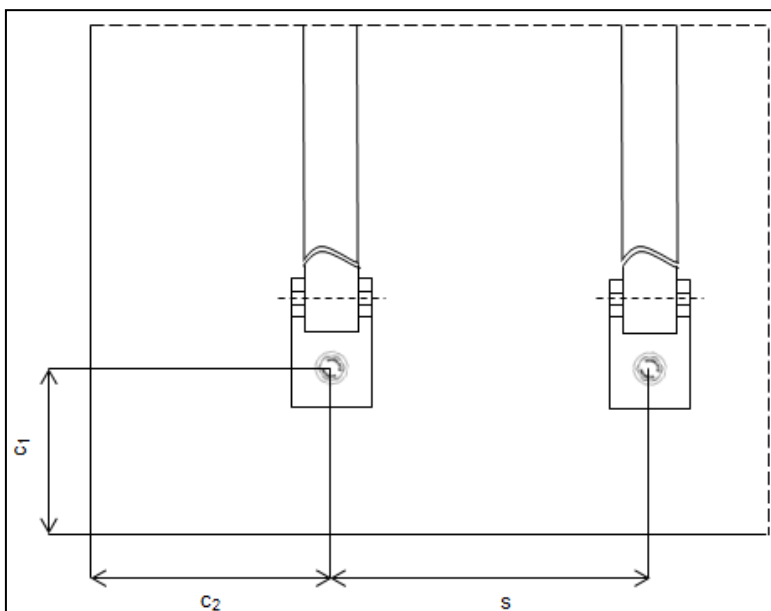

**Tube specification**

Anchor size / tube		8 / HRG 8	10 / HRG 10	14 / HRG 14
Inner tube diameter	$\varnothing_i$ [mm]	9,7	11,7	16,0
Outer tube diameter	$\varnothing_e$ [mm]	15,0	17,0	22,0
Tube length	Lt [mm]	23,0	28,0	40,3

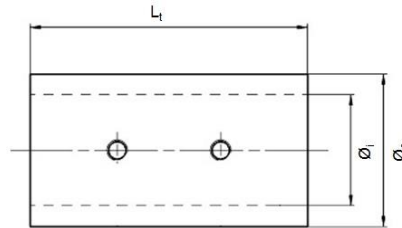
**Setting instructions**

\*For detailed information on installation see instruction for use given with the package of the product

Instruction for use – re-use of screw	
<b>1. Removing the anchor with Screw-driver</b> 	<b>2. Removing the anchor</b> 
<b>3. Checking with tube Hilti HRG</b> 	<b>4. Checking with tube Hilti HRG</b> 
<b>5. Drilling</b> 	<b>6. Reinstall based on setting instructions</b> 



**Basic loading data (for a single anchor) in solid masonry units**
**All data in this section applies to:**

- Load values valid for holes drilled with TE rotary hammers in hammering mod
- Correct anchor setting (see instruction for use, setting details)
- The core/material ratio may not exceed 15 % of a bed joint area
- The brim area around holes must be at least 70mm
- Edge distances, spacing and other influences, see below
- All data given in this section according to Hilti Technical Data

**Nominal embedment depth**

Anchor size		6	8	10
Nominal embedment depth	$h_{nom}$ [mm]	55	60	75

**Recommended loads for HUS3**

Anchor size			6	8	10
			A, H, I, C, P, PS, PL	H, C, HF	H, C, HF
Compressive strength class [N/mm <sup>2</sup> ]		F <sub>rec</sub> Tensile and shear loads			
	Solid clay brick Mz 12/2,0	≥ 8	0,6	-	-
		≥ 10	0,7	-	-
		≥ 12	0,8	1,1	1,4
	DIN 105 / EN 771-1	≥ 16	0,9	-	-
		≥ 20	0,9	1,6	2,0
	Solid sand-lime brick Mz 12/2,0	≥ 8	0,8	-	-
		≥ 10	0,9	-	-
		≥ 12	1,0	1,3	1,4
	DIN 106/EN 771-2	≥ 16	1,1	-	-
		≥ 20	1,2	1,7	2,1
	Aerated concrete PPW 6-0,4 DIN 4165/EN 771-4	≥ 6	0,4	0,7	0,9

## Permissible anchor location in brick and block walls

### Edge distance and spacing influence

- The technical data for HUS3 anchors are reference loads for MZ 12, KS 12 and PPW 6. Due to the large variation of natural stone slid bricks, on site anchor testing is recommended to validate technical data
- The HUS3 anchor was installed and tested in center of solid bricks as shown. The HUS3 anchor was not tested in the mortar joint between solid bricks or in hollow bricks, however a load reduction is expected
- For brick walls where anchor position in brick can not be determined, 100 % anchor testing is recommended
- Distance to free edge free edge to solid masonry (Mz and KS) units  $\geq 200\text{mm}$
- Distance to free edge free edge to solid masonry (autoclaved aerated gas concrete) units  $\geq 170\text{mm}$
- The minimum distance to horizontal and vertical mortar joint ( $c_{\min}$ ) is started in drawing below
- Minimum anchor spacing ( $s_{\min}$ ) in one brick/block is  $\geq 80\text{mm}$

### Limits

- All data is for multiple use for non-structural applications
- Plaster, graveling, lining or levelling courses are regarded as non-bearing and may not be taken into account for the calculation of embedment depth
- The decisive resistance to tension loads is the lower value of  $N_{\text{rec}}$  (brick breakout, pull out) and  $N_{\text{max,pb}}$  (pull out of one brick)

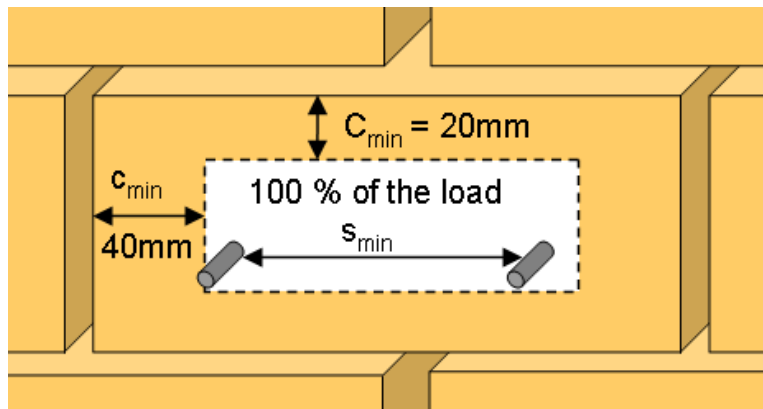

**Basic loading data for single anchor in Hollow core slab**
**All data in this section applies to**

- Correct setting (See setting instruction)
- No edge distance and spacing influence
- Ratio core width / web thickness  $w/e \leq 4,2$
- Concrete C 30/37 to C 50/60

**Characteristic resistance**

Anchor size			8	10
Type		HUS3	C, H, HF	C, H, HF
Bottom flange thickness	$d_b \geq$	[mm]	30	30
All load directions	$F_{Rk}$	[kN]	2,0	2,0

**Design resistance**

Anchor size			8	10
Type		HUS3	C, H, HF	C, H, HF
Bottom flange thickness	$d_b \geq$	[mm]	30	30
All load directions	$F_{Rd}$	[kN]	1,3	1,3

**Recommended loads**

Anchor size			8	10
Type		HUS3	C, H, HF	C, H, HF
Bottom flange thickness	$d_b \geq$	[mm]	30	30
All load directions <sup>a)</sup>	$F_{rec}$	[kN]	0,95	0,95

a) With overall partial safety factor for action  $\gamma = 1,4$ . The partial safety factors for action depend on the type of loading and shall be taken from national regulations.

Anchor Type	Size [mm]	Length [mm]	$d_b=30$ [mm]		$d_b=35$ [mm]		$d_b=40$ [mm]		$d_b=50$ [mm]	
			$t_{fix,min}$ [mm]	$t_{fix,max}$ [mm]	$t_{fix,min}$ [mm]	$t_{fix,max}$ [mm]	$t_{fix,min}$ [mm]	$t_{fix,max}$ [mm]	$t_{fix,min}$ [mm]	$t_{fix,max}$ [mm]
HUS3-H	8	55	5	15	5	10	5	5	5	5
		65	5	25	5	20	5	15	5	5
		75	5	35	5	30	5	25	5	15
		85	15	45	15	40	15	35	15	25
		100	30	60	30	55	30	50	30	40
		120	50	80	50	75	50	70	50	60
		150	80	110	80	105	80	100	80	90
HUS3-HF	8	65	5	25	5	20	5	15	5	5
		75	5	35	5	30	5	25	5	15
		85	15	45	15	40	15	35	15	25
		100	30	60	30	55	30	50	30	40
HUS3-C	8	65	15	25	15	20	15	15	15	5
		75	15	35	15	30	15	25	15	15
		85	15	45	15	40	15	35	15	25
HUS3-H	10	60	5	15	5	10	5	5	5	5
		70	15	25	15	20	15	15	15	5
		80	5	35	5	30	5	25	5	15
		90	5	45	5	40	5	35	5	25
		100	15	55	15	50	15	45	15	35
		110	25	65	25	60	25	55	25	45
		130	45	85	45	80	45	75	45	65
		150	65	105	65	100	65	95	65	85
HUS3-HF	10	60	5	15	5	10	5	5	5	5
		80	5	35	5	30	5	25	5	15
		100	15	55	15	50	15	45	15	35
		110	25	65	25	60	25	55	25	45
HUS3-C	10	70	15	25	15	20	15	15	15	10
		90	15	45	15	40	15	35	15	25
		100	15	55	15	50	15	45	15	35

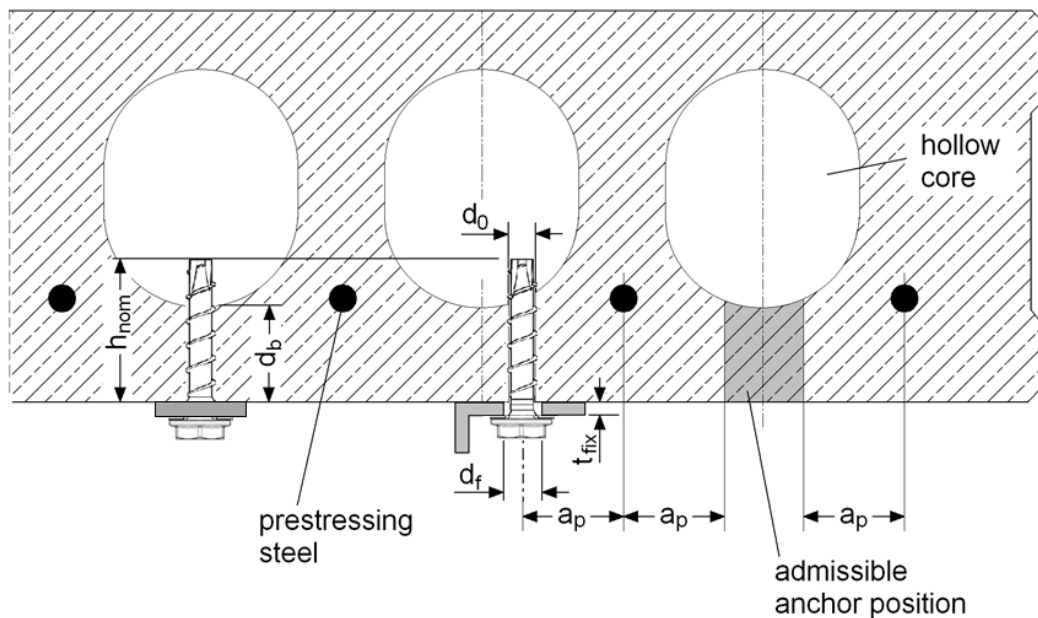

**Anchor spacing and edge distance**

Anchor size		8	10
Type	HUS3	C, H, HF	C, H, HF
Minimum edge distance	$c_{min} \geq$ [mm]	100	
Minimum anchor spacing	$s_{min} \geq$ [mm]	100	
Minimum distance between anchor groups	$a_{min} \geq$ [mm]	100	

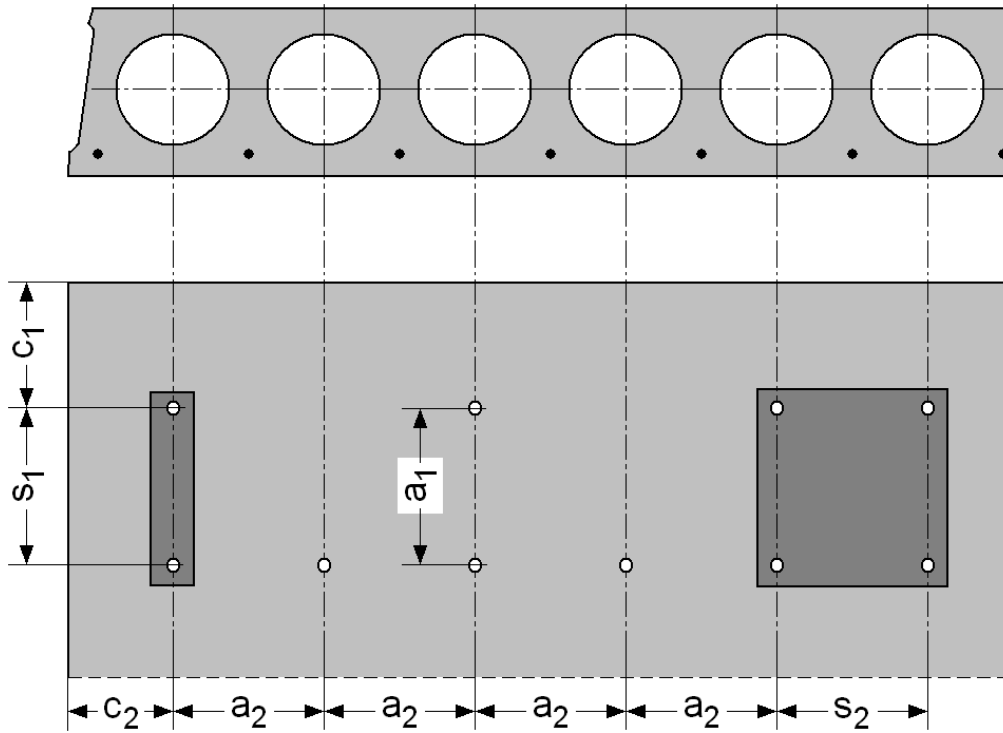

Setting instructions

\*For detailed information on installation see instruction for use given with the package of the product

Installation in hollow core slabs

1. Checking the anchor with tube Hilti HSB

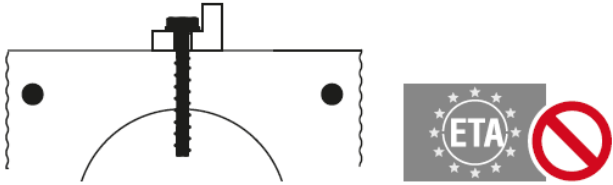

2. Positioning pre-stressed steel

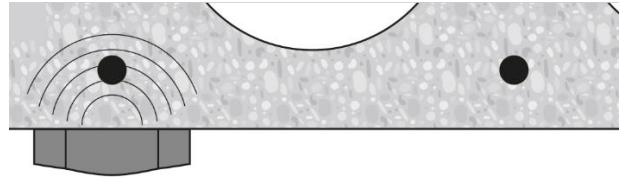

3. Marking pre-stressed steel position

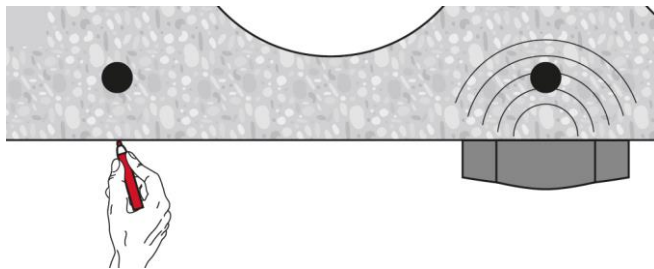

4. Marking pre-stressed steel position

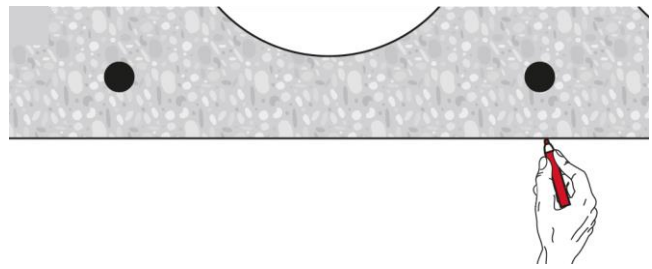

5. Drilling

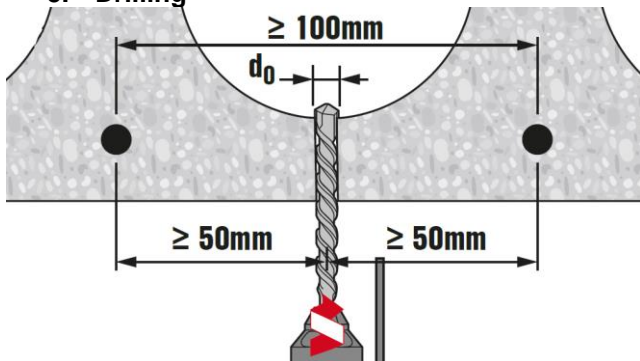

6. Setting the anchor

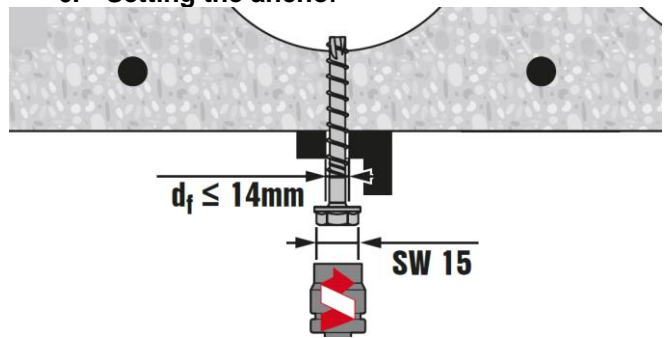

7. Setting the anchor

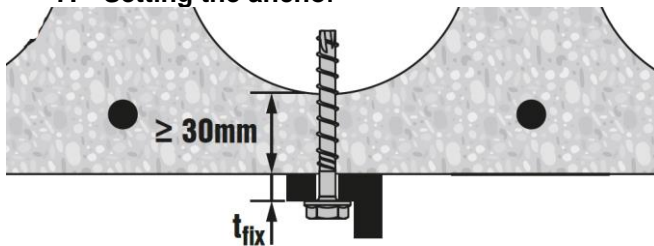

8. Checking

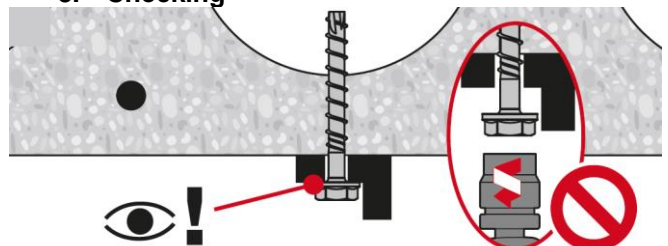



### 3.2.4 HUS-V

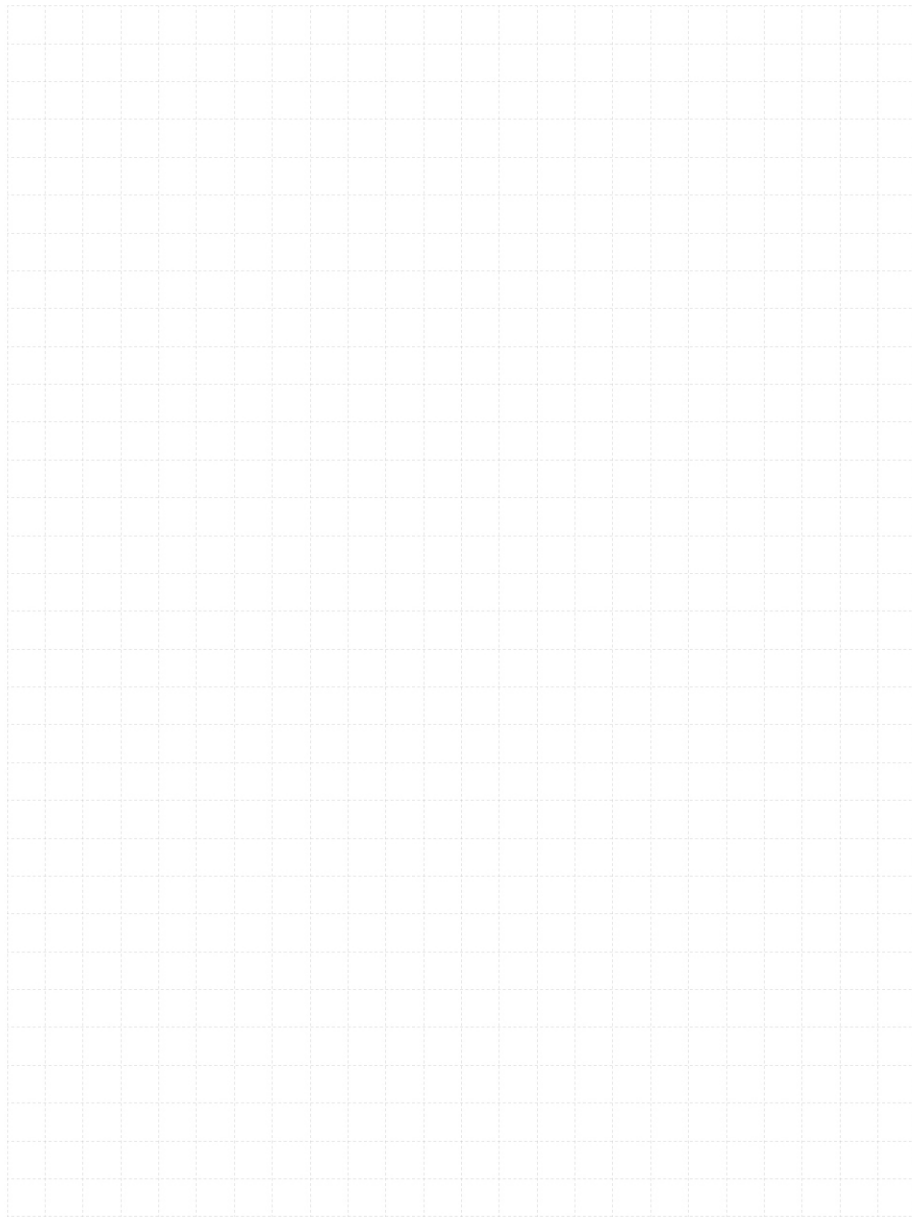

# HUS-V Screw anchors

## Economical screw anchor with hex head

### Anchor version



HUS-V  
(8-10)

### Benefits

- High productivity- less drilling and fewer operations than with conventional anchors
- Suitable for cracked and non-cracked concrete C20/25
- Technical data for cracked and non-cracked concrete
- Technical data for reusability in fresh concrete ( $f_{ck,cube} = 10/15/20 \text{ Nmm}^2$ ) for temporary applications
- Two embedment depths for maximum design flexibility

### Base material

### Installation conditions



Concrete  
(non-cracked)

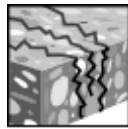

Concrete  
(cracked)



Tensile  
zone

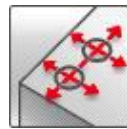

Small edge  
distance and  
spacing

### Basic loading data (for a single anchor)

#### All data in this section applies to:

- Correct setting (See setting instruction)
- No edge distance and spacing influence
- **Steel** failure
- Minimum base material thickness
- Concrete C 20/25,  $f_{ck,cube} = 25 \text{ N/mm}^2$
- Adjustment allowed during the installation for size 8 and 10,  $h_{nom2}$  only.

#### Effective anchorage depth for static

Anchor size		8		10	
Eff. Anchorage depth	$h_{ef}$ [mm]	50	65	55	75

#### Mean ultimate resistance

Anchor size		8		10		
<b>Non-cracked concrete</b>						
Tension $N_{Ru,m}$	HUS-V	[kN]	11,9	21,2	11,9	26,6
Shear $V_{Ru,m}$	HUS-V	[kN]	16,4	16,7	18,6	20,5
<b>Cracked concrete</b>						
Tension $N_{Ru,m}$	HUS-V	[kN]	5,3	11,9	8,0	21,2
Shear $V_{Ru,m}$	HUS-V	[kN]	11,7	16,7	13,2	20,5

### Characteristic resistance

Anchor size		8		10		
<b>Non-cracked concrete</b>						
Tension $N_{Rk}$	HUS-V	[kN]	9,0	16,0	9,0	20,0
Shear $V_{Rk}$	HUS-V	[kN]	12,3	15,9	14,0	19,5
<b>Cracked concrete</b>						
Tension $N_{Rk}$	HUS-V	[kN]	4,0	9,0	6,0	16,0
Shear $V_{Rk}$	HUS-V	[kN]	8,8	15,9	10,0	19,5

### Design resistance

Anchor size		8		10		
<b>Non-cracked concrete</b>						
Tension $N_{Rd}$	HUS-V	[kN]	5,0	8,9	5,0	9,5
Shear $V_{Rd}$	HUS-V	[kN]	6,9	10,6	7,8	13,0
<b>Cracked concrete</b>						
Tension $N_{Rd}$	HUS-V	[kN]	2,2	5,0	3,3	7,5
Shear $V_{Rd}$	HUS-V	[kN]	4,9	10,9	5,5	13,0

### Recommended loads<sup>a)</sup>

Anchor size		8		10		
<b>Non-cracked concrete</b>						
Tension $N_{Rec}$	HUS-V	[kN]	3,6	6,3	3,6	6,8
Shear $V_{Rec}$	HUS-V	[kN]	4,9	7,6	5,6	9,3
<b>Cracked concrete</b>						
Tension $N_{Rec}$	HUS-V	[kN]	1,6	3,6	2,4	5,4
Shear $V_{Rec}$	HUS-V	[kN]	3,5	7,6	4,0	9,3

a) With overall partial safety factor for action  $\gamma = 1,4$ . The partial safety factors for action depend on the type of loading and shall be taken from national regulations.

### Materials

#### Mechanical properties

Anchor size		8		10	
Nominal tensile strength $f_{uk}$		[N/mm <sup>2</sup> ]	880		715
Yield strength $f_{yk}$		[N/mm <sup>2</sup> ]	755		610
Stressed cross-section $A_s$		[mm <sup>2</sup> ]	36,6		59,4
Moment of resistance $W$		[mm <sup>3</sup> ]	35		65
Characteristic bending resistance $M^{0}_{Rk,s}$		[Nm]	37,1		55,5

#### Material quality

Part	Material
HUS-V	Carbon steel; Galvanized $\geq 5 \mu\text{m}$

#### Anchor dimensions

Anchor size		8		10	
Threaded outer diameter	$d_t$	[mm]	10,6		12,65
Core diameter	$d_k$	[mm]	7,1		8,7
Shaft diameter	$d_s$	[mm]	8,45		10,55
Stressed section	$A_s$	[mm <sup>2</sup> ]	36,6		59,4

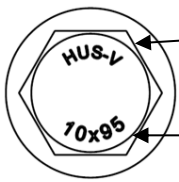
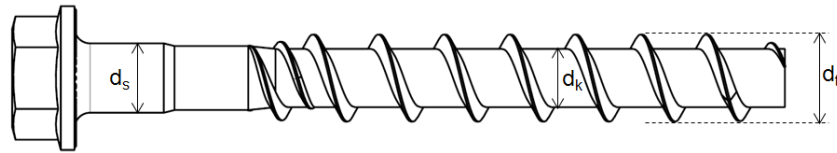

**HUS-V** : Hilti Universal Screw – hexagonal head

**10x95** : screw diameter x screw length

### Screw length and thickness of fixture for HUS-v (hex head)

Anchor size		8		10	
Nominal anchorage depth	$h_{nom1}, h_{nom2}$ [mm]	50	65	55	75
Thickness of fixture		$t_{fix1}$	$t_{fix2}$	$t_{fix1}$	$t_{fix2}$
Length of anchor [mm]	55	5	-	-	-
	60	-	-	5	-
	75	25	15	-	-
	85	35	25	30	10
	95	45	35	40	20
	105	-	-	50	30

### Setting information

#### Setting details

Anchor size		8		10	
Thread engagement length	$h_{nom}$ [mm]	50	65	55	75
Nominal diameter of drill bit	$d_0$	8		10	
Cutting diameter of drill bit	$d_{cut} \leq$ [mm]	8,45		10,45	
Drill hole depth	$h_1 \geq$ [mm]	60	75	65	85
Maximum diameter of clearance hole in the fixture <sup>2)</sup>	$d_f \leq$ [mm]	12		14	
Width across	SW [mm]	13		15	

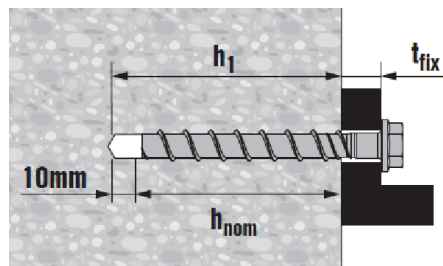

#### Installation equipment

Anchor size	8	10
Rotary hammer	TE 2 – TE 30	
Drill bit for concrete	CX 8	CX 10
Socket wrench insert	S-NSD 13 1/2	S-NSD 15 1/2
Tube for temporary application	HRG 8	HRG 10
Setting tool for concrete C12/15 to C50/60	SIW 22T-A – SIW 22-A	

### Setting parameters

Anchor size		8		10	
Nominal anchorage depth	$h_{nom}$ [mm]	50	65	55	75
Effective anchorage depth	$h_{ef}$ [mm]	39,1	51,9	42,5	59,5
Minimum base material thickness	$h_{min}$ [mm]	100	110	100	130
Minimum spacing	$s_{min}$ [mm]	40	50	50	50
Minimum edge distance	$c_{min}$ [mm]	50	50	50	50
Critical spacing for splitting failure	$s_{cr,sp}$ [mm]	117,3	140	130	180
Critical edge distance for splitting failure	$c_{cr,sp}$ [mm]	58,65	70	65	90
Critical spacing for concrete cone failure	$s_{cr,N}$ [mm]	117,3	177,3	127,5	178,5
Critical edge distance for concrete cone failure	$c_{cr,sp}$ [mm]	58,65	88,65	63,75	89,25

For spacing (edge distance) smaller than critical spacing (critical edge distance) the design loads have to be reduced.

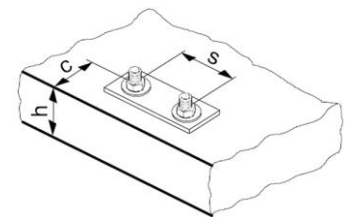

### Setting instructions

\*For detailed information on installation see instruction for use given with the package of the product

Setting instruction	
<p><b>1. Make a cylinder hole</b></p>	<p><b>2. Clean the borehole</b></p>
<p><b>3. Install the screw anchor by impact screw driver</b></p>	<p><b>4. Ensure that the fixture is caught</b></p>

**Basic loading data for temporary application in standard and fresh concrete < 28 days old,  $f_{ck,cube} \geq 10 \text{ N/mm}^2$ :**
**All data in this section applies to the following conditions:**

- Strength class,  $f_{ck,cube} \geq 10 \text{ N/mm}^2$
- Only temporary use
- Screw is reusable, before each usage it must be checked according Hilti instruction for use with the suited tube Hilti HRG
- Design resistance and recommended load are valid for single anchor only
- Design resistance as well as the recommended load are valid for all load direction and valid for both cracked and non-cracked concrete
- Minimum base material thickness
- No edge distance and spacing influence

**Design resistance**

Anchor size	HUS-V	8		10	
Nominal embedment depth	$h_{nom} \text{ [mm]}$	50	65	55	75
Cracked and non-cracked concrete					
Tensile $N_{Rd} = \text{Shear } V_{Rd}$					
$f_{ck,cube} \geq 10 \text{ N/mm}^2$	[kN]	1,4	3,0	1,7	3,2
$f_{ck,cube} \geq 15 \text{ N/mm}^2$	[kN]	1,7	3,7	2,1	3,9
$f_{ck,cube} \geq 20 \text{ N/mm}^2$	[kN]	2,0	4,2	2,4	4,5

**Recommended load**

Anchor size	HUS-V	8		10	
Nominal embedment depth	$h_{nom} \text{ [mm]}$	50	65	55	75
Tensile $N_{rec} = \text{Shear } V_{rec}$					
$f_{ck,cube} \geq 10 \text{ N/mm}^2$	[kN]	1,0	2,1	1,2	2,3
$f_{ck,cube} \geq 15 \text{ N/mm}^2$	[kN]	1,2	2,6	1,5	2,8
$f_{ck,cube} \geq 20 \text{ N/mm}^2$	[kN]	1,4	3,0	1,7	3,2

a) With overall partial safety factor for action  $\psi = 1,4$ . The partial safety factors for action depend on the type of loading and shall be taken from national regulations.

**Setting details**

Anchor size		HUS-V	8		10	
Nominal anchorage depth	$h_{nom}$	[mm]	50	65	55	75
Minimum base material thickness	$h_{min}$	[mm]	100	110	100	130
Minimum spacing	$s_{min}$	[mm]	135	225	150	240
Minimum edge distance direction 1	$c_1$	[mm]	45	75	50	80
Minimum edge distance direction 2	$c_2$	[mm]	70	115	75	120

**Setting details**

Anchor size		HUS-V	8		10	
Nominal anchorage depth	$h_{nom}$	[mm]	50	65	55	75
Nominal diameter of drill bit	$d_o$	[mm]	8		10	
Cutting diameter of drill bit	$d_{cut} \leq$	[mm]	8,45		10,45	
Depth of drill bit	$h_1 \leq$	[mm]	60	75	65	85
Diameter of clearance hole the fixture	$d_f \leq$	[mm]	12		14	
Width across	SW	[mm]	13		15	
Impact screw driver	Hilti SIW 22 T-A or SIW 22 A					
Suited tube			Hilti HRG 8		Hilti HRG 10	

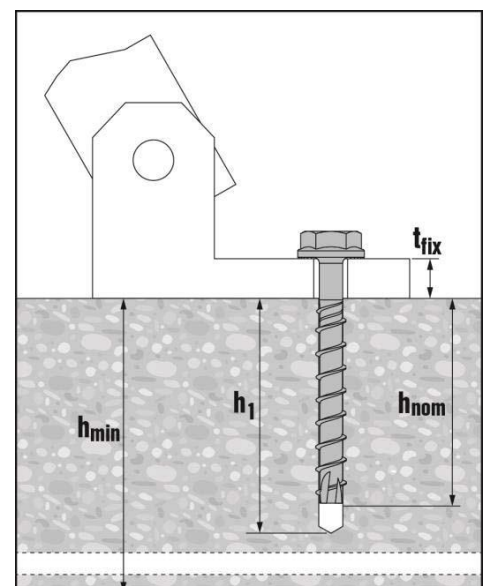
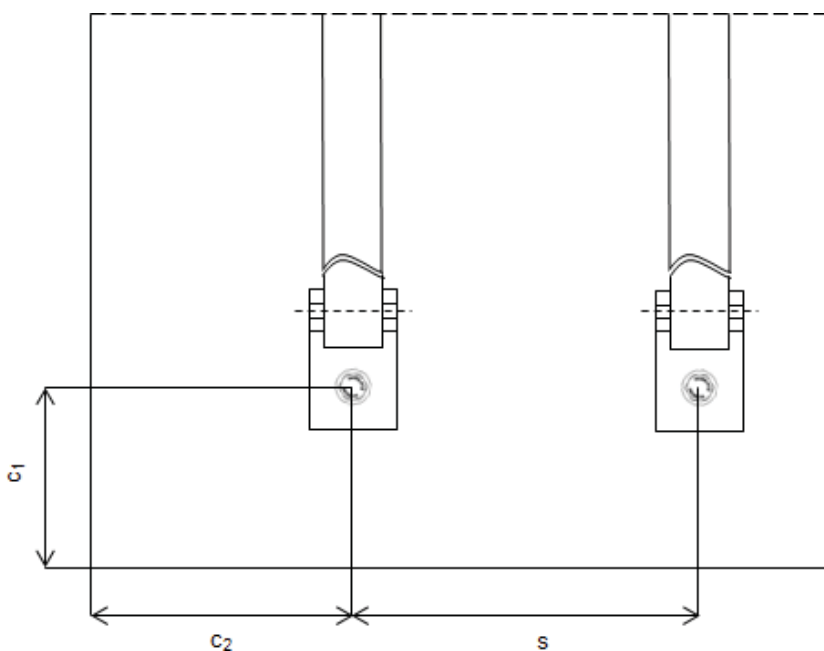

**Tube specification**

Anchor size / tube			8 / HRG 8	10 / HRG 10
Inner tube diameter	$\varnothing_i$	[mm]	9,7	11,7
Outer tube diameter	$\varnothing_e$	[mm]	15,0	17,0
Tube length	Lt	[mm]	23,0	28,0

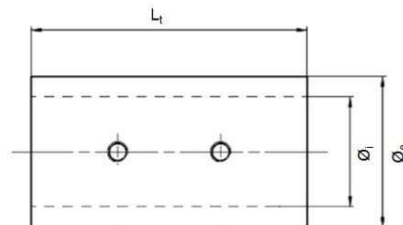
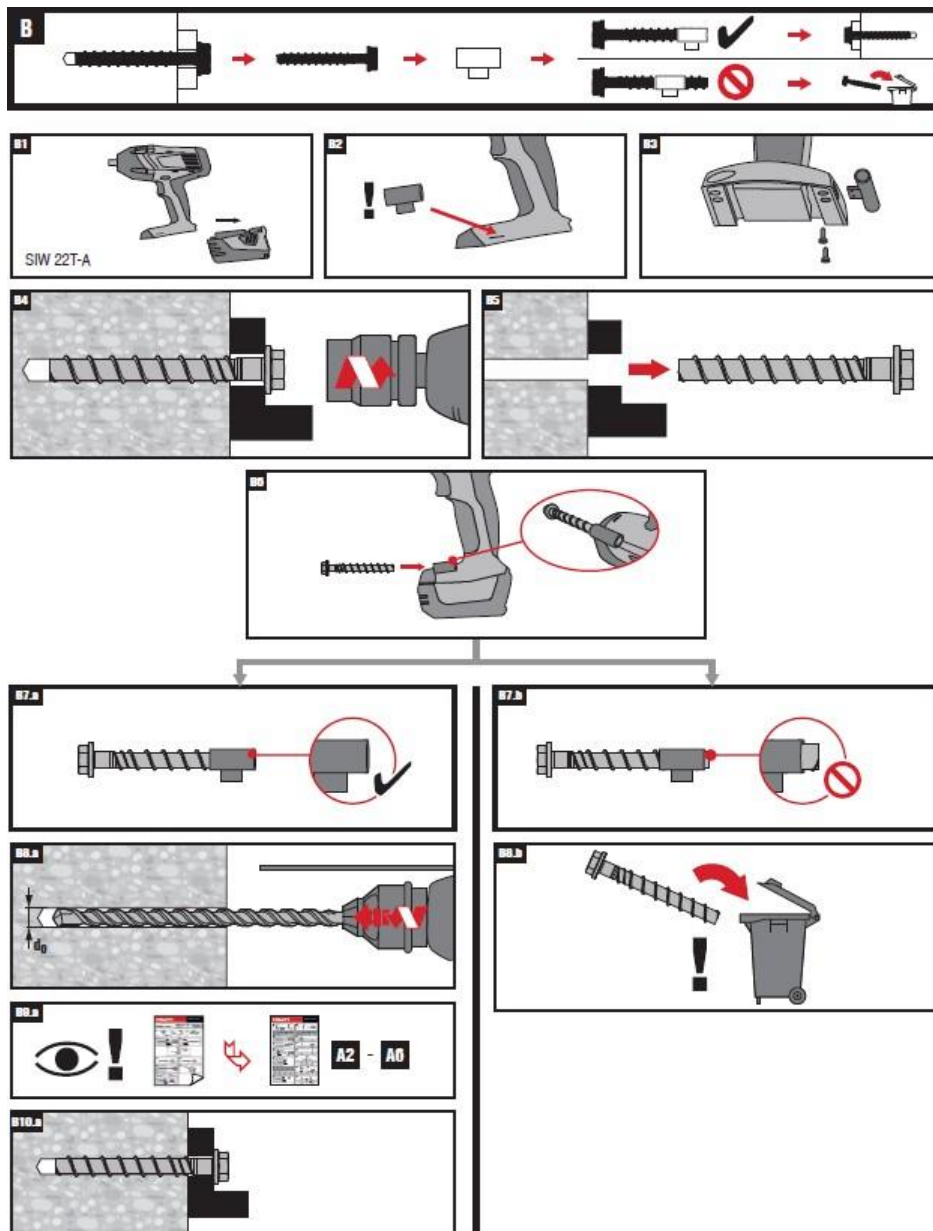
**Instruction for use – re-use of screw**



### 3.2.5 HUS2-H

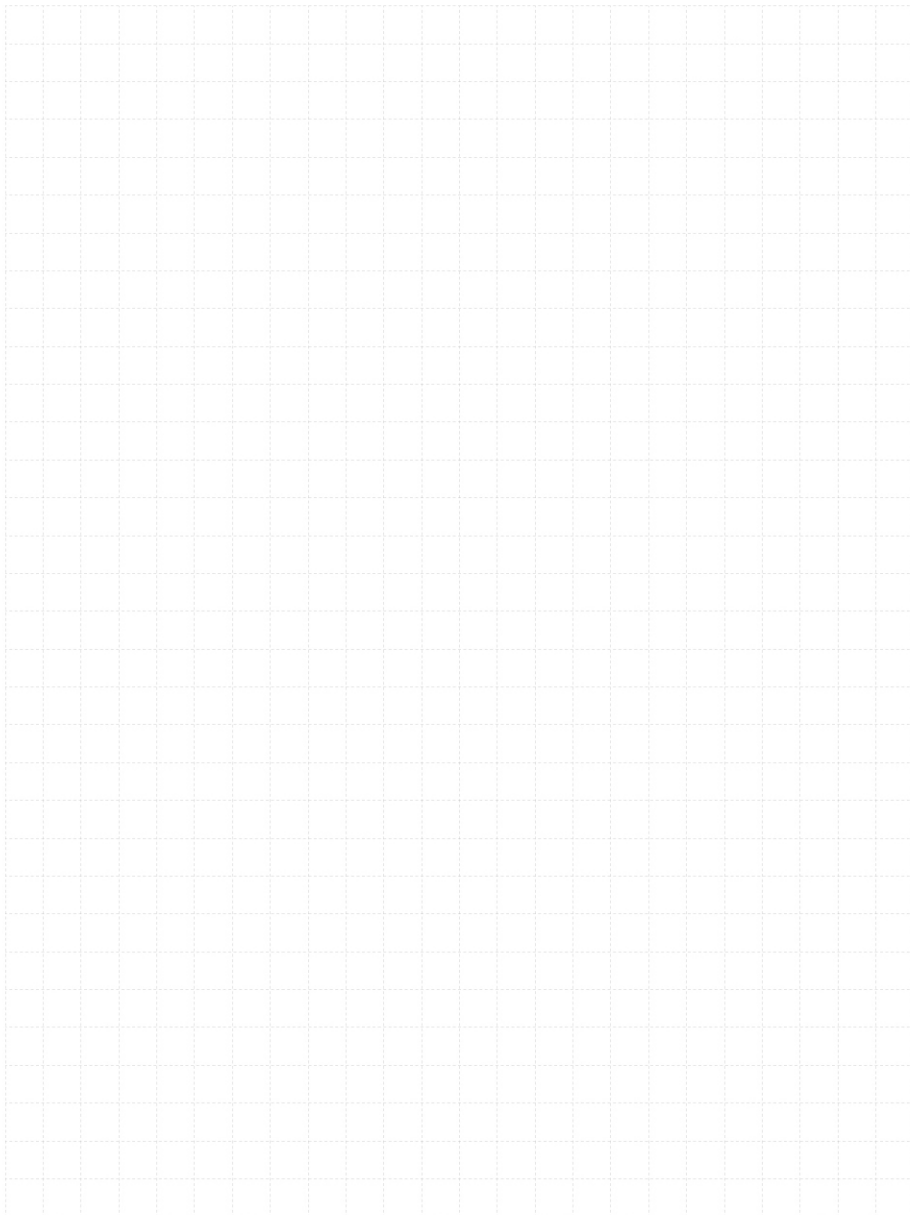

# HUS2-H Screw anchors

Premium screw anchor for use in concrete with hex head

## Anchor version



HUS2-H  
(8-10)

## Benefits

- High productivity- less drilling and fewer operations than with conventional anchors
- Suitable for cracked and non-cracked concrete C20/25
- ETA approval for cracked and non-cracked concrete
- Technical data for reusability in fresh concrete ( $f_{ck,cube} = 10/15/20 \text{ Nmm}^2$ ) for temporary applications
- Two embedment depths for maximum design flexibility

## Base material



Concrete  
(non-cracked)



Concrete  
(cracked)

## Load condition

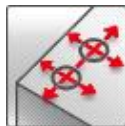

Small edge  
distance  
and spacing



Static /  
quasi-static



Fire  
resistance



European  
Technical  
Assessment



CE  
conformity

## Approvals / certificates

Description	Authority / Laboratory	No. / date of issue
European Technical Assessment	ZAG, Ljubjana	ETA-19/0170 / 2019-08-30
Fire test report	ZAG, Ljubjana	ETA-19/0170 / 2019-08-30

a) All data given in this section for  $h_{nom}$  equal to 65 and 75 of size 8 and 10, respectively, is according ETA-19/0170 issue 2019-08-30.

**Static and quasi-static loading data (for a single anchor)**
**All data in this section applies to:**

- Correct setting (See setting instruction)
- No edge distance and spacing influence
- Steel failure
- Minimum base material thickness
- Concrete C 20/25,  $f_{ck,cube} = 25 \text{ N/mm}^2$

**Anchorage depth**

		Hilti Technical Data		ETA 19/0170	
Anchor size		8	10	8	10
Nominal embedment depth	$h_{nom}$ [mm]	50	55	65	75

**Characteristic resistance**

		Hilti Technical Data		ETA 19/0170		
Anchor size		8	10	8	10	
<b>Non-cracked concrete</b>						
Tension	HUS2-H	$N_{Rk}$ [kN]	9,0	9,0	16,0	20,0
Shear	HUS2-H	$V_{Rk}$ [kN]	12,0	13,6	18,4	22,7
<b>Cracked concrete</b>						
Tension	HUS2-H	$N_{Rk}$ [kN]	4,0	6,0	9,0	14,0
Shear	HUS2-H	$V_{Rk}$ [kN]	8,4	9,5	18,4	22,7

**Design resistance**

		Hilti Technical Data		ETA 19/0170		
Anchor size		8	10	8	10	
<b>Non-cracked concrete</b>						
Tension	HUS2-H	$N_{Rd}$ [kN]	5,0	5,0	8,9	11,1
Shear	HUS2-H	$V_{Rd}$ [kN]	8,0	9,1	12,3	15,1
<b>Cracked concrete</b>						
Tension	HUS2-H	$N_{Rd}$ [kN]	2,2	3,3	5,0	7,8
Shear	HUS2-H	$V_{Rd}$ [kN]	5,6	6,4	12,3	15,1

**Recommended loads <sup>a)</sup>**

		Hilti Technical Data		ETA 19/0170		
Anchor size		8	10	8	10	
<b>Non-cracked concrete</b>						
Tension	HUS2-H	$N_{Rec}$ [kN]	3,6	3,6	6,4	7,9
Shear	HUS2-H	$V_{Rec}$ [kN]	5,7	6,5	8,8	10,8
<b>Cracked concrete</b>						
Tension	HUS2-H	$N_{Rec}$ [kN]	1,6	2,4	3,6	5,6
Shear	HUS2-H	$V_{Rec}$ [kN]	4,0	4,6	8,8	10,8

a) With overall partial safety factor for action  $\gamma = 1,4$ . The partial safety factors for action depend on the type of loading and shall be taken from national regulations.

## Fire resistance

### All data in this section applies to:

- Correct setting (See setting instruction)
- No edge distance and spacing influence
- Steel failure
- Minimum base material thickness
- Concrete C 20/25,  $f_{ck,cyl} = 20 \text{ N/mm}^2$  (EN 1992-4 design)
- Partial safety factor for resistance under fire exposure  $\gamma_{M,fi}=1,0$  (in absence of other national regulations)

### Nominal embedment depth

			Hilti Technical Data		ETA 19/0170	
Anchor size			8	10	8	10
Nominal embedment depth	$h_{nom}$	[mm]	50	55	65	75

### Characteristic resistance

			Hilti Technical Data		ETA 19/0170	
Anchor size			8	10	8	10
<b>Fire exposure R30</b>						
Tension	HUS2-H	$N_{Rk,fi}$ [kN]	-	-	0,4	0,89
Shear	HUS2-H	$V_{Rk,fi}$ [kN]	-	-	0,4	0,89
<b>Fire exposure R120</b>						
Tension	HUS2-H	$N_{Rk,fi}$ [kN]	-	-	0,2	0,48
Shear	HUS2-H	$V_{Rk,fi}$ [kN]	-	-	0,2	0,48

### Design resistance

			Hilti Technical Data		ETA 19/0170	
Anchor size			8	10	8	10
<b>Fire exposure R30</b>						
Tension	HUS2-H	$N_{Rd,fi}$ [kN]	-	-	0,4	0,89
Shear	HUS2-H	$V_{Rd,fi}$ [kN]	-	-	0,4	0,89
<b>Fire exposure R120</b>						
Tension	HUS2-H	$N_{Rd,fi}$ [kN]	-	-	0,2	0,48
Shear	HUS2-H	$V_{Rd,fi}$ [kN]	-	-	0,2	0,48

## Materials

### Mechanical properties

Anchor size			8	10
Nominal tensile strength	$f_{uk}$	[N/mm <sup>2</sup> ]	880	715
Yield strength	$f_{yk}$	[N/mm <sup>2</sup> ]	755	610
Stressed cross-section	$A_s$	[mm <sup>2</sup> ]	39,6	59,4
Moment of resistance	$W$	[mm <sup>3</sup> ]	35	65
Characteristic bending resistance	$M^0_{Rk,s}$	[Nm]	37	55

### Material quality

Part	Material
HUS2-H	Carbon steel; Galvanized $\geq 5 \mu\text{m}$

### Anchor dimensions

Anchor size			8	10
Threaded outer diameter	$d_t$	[mm]	10,6	12,65
Core diameter	$d_k$	[mm]	7,1	8,7
Shaft diameter	$d_s$	[mm]	8,45	10,55
Stressed section	$A_s$	[mm <sup>2</sup> ]	39,6	59,4

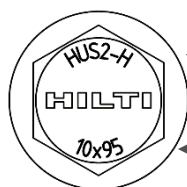
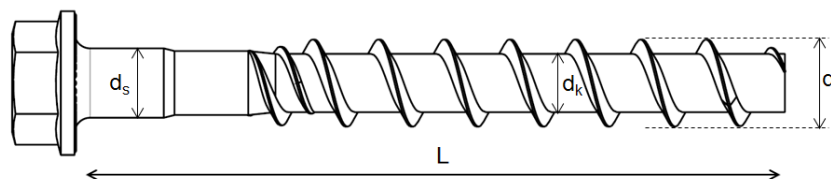

**HUS2-H** : Premium Hilti Screw anchor – hexagonal head

**10x95** : screw diameter x screw length

### Screw length and thickness of fixture for HUS2-H (hex head)

Anchor size			8		10	
Nominal anchorage depth	$h_{nom1}, h_{nom2}$	[mm]	50	65	55	75
Thickness of fixture			$t_{fix1}$	$t_{fix2}$	$t_{fix1}$	$t_{fix2}$
Length of anchor [mm]	55		5	-	-	-
	60		-	-	5	-
	75		25	10	-	-
	85		35	20	30	10
	95		45	30	40	20
	105		-	-	50	30
	130		-	-	75	55

## Setting information

### Setting details

Anchor size			8		10	
Nominal embedment depth	$h_{nom}$	[mm]	50	65	55	75
Nominal diameter of drill bit	$d_0$		8		10	
Cutting diameter of drill bit	$d_{cut} \leq$	[mm]	8,45		10,45	
Drill hole depth	$h_1 \geq$	[mm]	60	75	65	85
Maximum diameter of clearance hole in the fixture <sup>2)</sup>	$d_f \leq$	[mm]	12		14	
Wrench size	SW	[mm]	13		15	

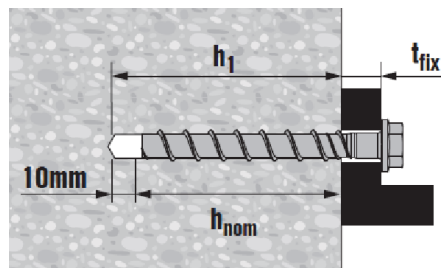

### Installation equipment

Anchor size			8		10	
Rotary hammer			TE 2 – TE 30			
Drill bit for concrete			CX 8		CX 10	
Socket wrench insert			S-NSD 13 1/2		S-NSD 15 1/2	
Tube for temporary application			HRG D=8-10-14 MM			
Setting tool for concrete	C20/25		SIW 22 T-A 1/2"; SIW 6AT-A22			
	C20/25 – C50/60		SIW 22 T-A			

### Setting parameters

Anchor size			8		10	
Nominal embedment depth	$h_{nom}$	[mm]	50	65	55	75
Effective anchorage depth	$h_{ef}$	[mm]	39,1	51,9	42,5	59,5
Minimum base material thickness	$h_{min}$	[mm]	100	110	100	130
Minimum spacing	$s_{min}$	[mm]	40	50	50	50
Minimum edge distance	$c_{min}$	[mm]	50	50	50	50
Critical spacing for splitting failure	$s_{cr,sp}$	[mm]	117	140	130	180
Critical edge distance for splitting failure	$c_{cr,sp}$	[mm]	59	70	65	90
Critical spacing for concrete cone failure	$s_{cr,N}$	[mm]	117,3	155,7	127,5	178,5
Critical edge distance for concrete cone failure	$c_{cr,N}$	[mm]	58,65	77,85	63,75	89,25

For spacing (edge distance) smaller than critical spacing (critical edge distance) the design loads have to be reduced.

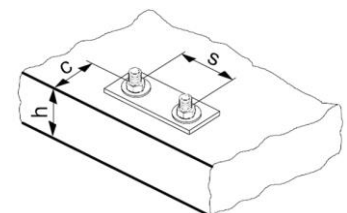

**Setting instructions**

Setting instruction	
<b>1. Make a cylinder hole</b> 	<b>2. Clean the borehole</b> 
<b>3. Install the screw anchor by impact screw driver</b> 	<b>4. Ensure that the fixture is caught</b> 

\*For detailed information on installation see instruction for use given with the package of the product

**Basic loading data for temporary application in standard & fresh concrete < 28 days old,  $f_{ck,cube} \geq 10 \text{ N/mm}^2$ :**
**All data in this section applies to the following conditions:**

- Strength class,  $f_{ck,cube} \geq 10 \text{ N/mm}^2$
- Only temporary use
- Screw is reusable, before each usage it must be checked according Hilti instruction for use with the suited tube Hilti HRG D=8,10,14 MM
- Design resistance and recommended load are valid for single anchor only
- Design resistance as well as the recommended load are valid for all load direction and valid for both cracked and non-cracked concrete
- Minimum base material thickness
- No edge distance and spacing influence

**Anchorage depth**

Anchor size			8		10	
Nominal embedment depth	$h_{nom}$	[mm]	50	65	55	75

**Design resistance**

Anchor size			8		10		
<b>Cracked and non-cracked concrete</b>							
Tensile	$f_{ck,cube} \geq 10 \text{ N/mm}^2$	$N_{Rd} = V_{Rd}$	[kN]	1,4	3,0	1,7	3,2
=	$f_{ck,cube} \geq 15 \text{ N/mm}^2$		[kN]	1,7	3,7	2,1	3,9
Shear	$f_{ck,cube} \geq 20 \text{ N/mm}^2$		[kN]	2,0	4,2	2,4	4,5

**Recommended<sup>a)</sup> loads**

Anchor size			8		10		
<b>Cracked and non-cracked concrete</b>							
Tensile	$f_{ck,cube} \geq 10 \text{ N/mm}^2$	$N_{Rec} = V_{Rec}$	[kN]	1,0	2,1	1,2	2,3
=	$f_{ck,cube} \geq 15 \text{ N/mm}^2$		[kN]	1,2	2,6	1,5	2,8
Shear	$f_{ck,cube} \geq 20 \text{ N/mm}^2$		[kN]	1,4	3,0	1,7	3,2

a) With overall partial safety factor for action  $\gamma = 1,4$ . The partial safety factors for action depend on the type of loading and shall be taken from national regulations.

**Setting details**

Anchor size			8		10	
Nominal anchorage depth	$h_{nom}$	[mm]	50	65	55	75
Minimum base material thickness	$h_{min}$	[mm]	100	110	100	130
Minimum spacing	$s_{min}$	[mm]	135	225	150	240
Minimum edge distance direction 1	$c_1$	[mm]	45	75	50	80
Minimum edge distance direction 2	$c_2$	[mm]	70	115	75	120

**Setting details**

Anchor size			8		10	
Nominal anchorage depth	$h_{nom}$	[mm]	50	65	55	75
Nominal diameter of drill bit	$d_o$	[mm]	8		10	
Cutting diameter of drill bit	$d_{cut} \leq$	[mm]	8,45		10,45	
Depth of drill bit	$h_1 \leq$	[mm]	60	75	65	85
Diameter of clearance hole the fixture	$d_f \leq$	[mm]	12		14	
Width across	SW	[mm]	13		15	
Impact screw driver			SIW 22T-A 1/2"; SIW 6AT-A22			
Suited tube			HRG D=8-14 MM			

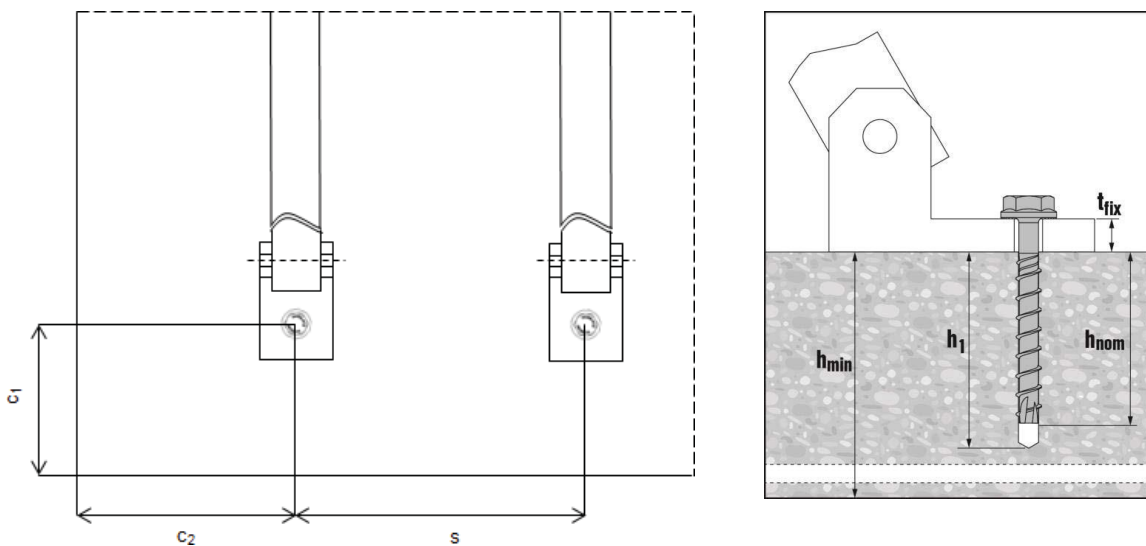
**Tube specification**

Anchor size / tube		8 / HRG 8	10 / HRG 10
Inner tube diameter	$\varnothing_i$ [mm]	9,7	11,7
Outer tube diameter	$\varnothing_e$ [mm]	15,0	17,0
Tube length	Lt [mm]	23,0	28,0



### Instruction for use – re-use of screw

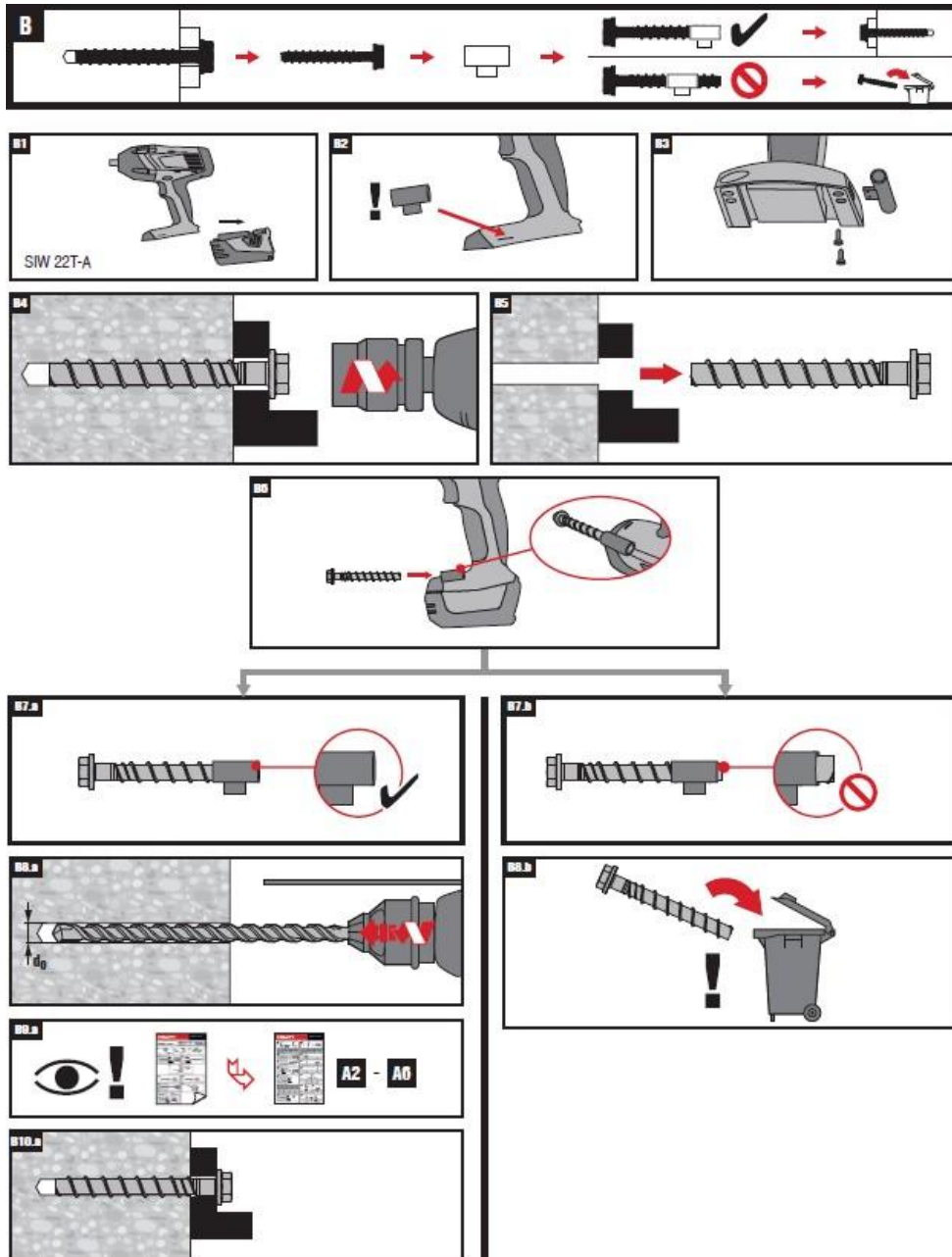

### 3.2.6 HUS 6/ HUS-S 6

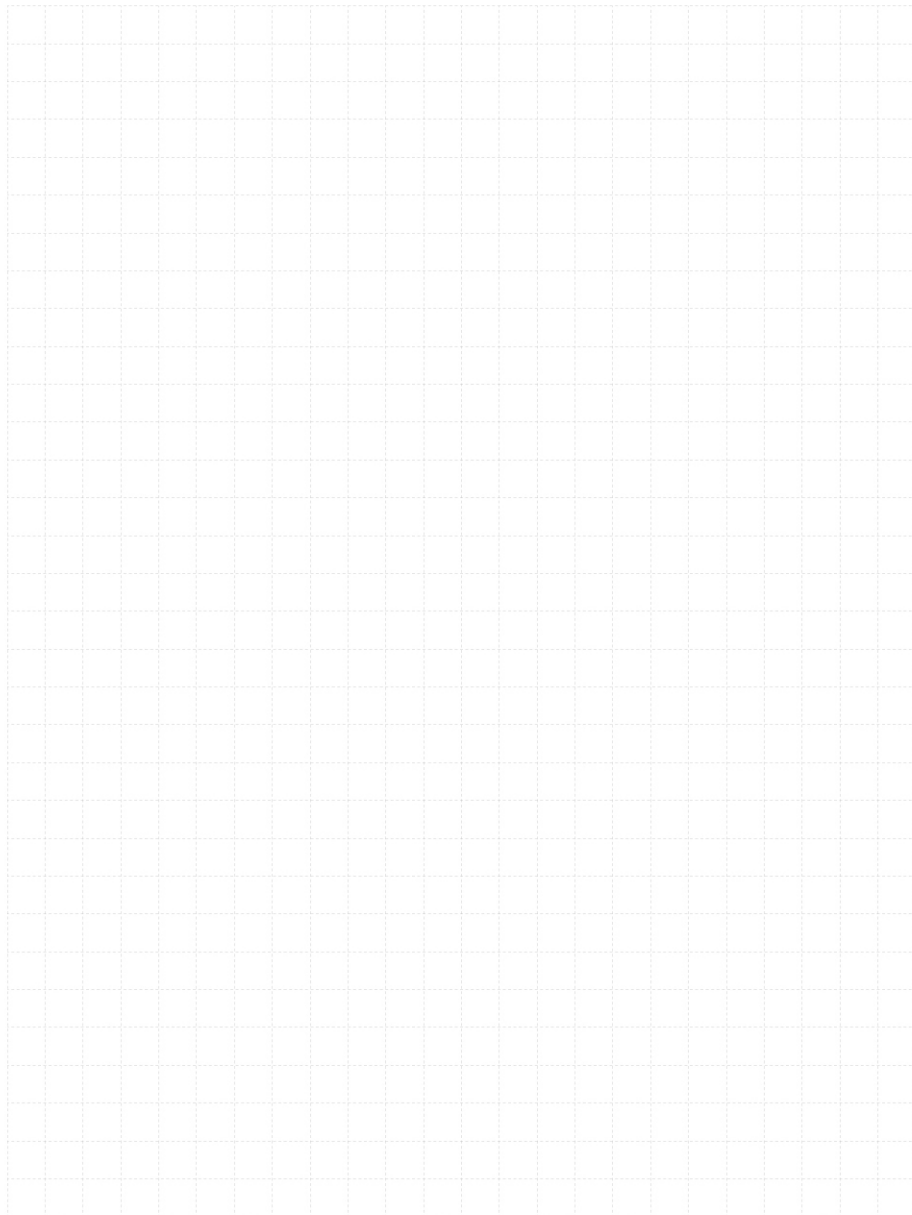

# HUS 6 / HUS-S 6 Screw anchor

## Everyday standard screw anchor

### Anchor version



HUS 6  
(6)



HUS-S 6  
(6)

### Benefits

- Quick and easy setting
- Low expansion forces in base materials
- Through fastening
- Removable

### Base material



Concrete  
(non-cracked)

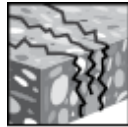

Concrete  
(cracked)

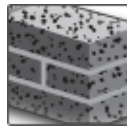

Solid brick

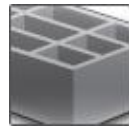

Hollow brick

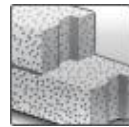

Autoclaved  
aerated  
concrete



Fire  
resistance

### Load conditions

### Installation conditions

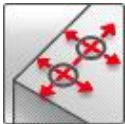

Small edge  
distance and  
spacing

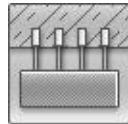

Redundant  
fastening

### Approvals / certificates

Description	Authority / Laboratory	No. / date of issue
Assessment report (fire)	IBMB / MPA Braunschweig	2100/759/17 / 2018-02-16

## Basic loading data (for a single anchor)

### All data in this section applies to:

- Correct setting (See setting instruction)
- No edge distance and spacing influence
- Concrete as specified in the table
- Minimum base material thickness
- Applied loads to individual bricks/blocks without compression may not exceed 1,0 kN
- Applied loads to individual bricks/blocks with compression may not exceed 1,4 kN
- Data applies only to bricks/blocks, there is no test data available for loads in mortar joints. Hilti recommends at least 50% load reduction or on site testing, if the location of the anchor in relation to the joint can not be specified because of wall plaster or insulation.
- Plaster, gravelling, lining or levelling courses are regarded as non-bearing and may not be taken into account for calculation of embedment depth

### Note:

When tightening the screw anchor in soft base materials and in hollow brick, care must be taken not to apply too much torque. If the screw anchor is over-tightened the fastening point is unusable for the HUS 6.

### Anchorage depth

Anchor size		HUS 6		
Nominal embedment depth	$h_{nom}$ [mm]	34	44	64

### Recommended loads <sup>a)</sup> for all load directions

Anchor size		HUS 6			
Base material	Edge distance				
<b>Non-cracked concrete</b> ≥ C20/25	c ≥ 30 mm	$N_{Rec}$	1,0	-	-
		$V_{Rec}$ [kN]	0,5	-	-
	c ≥ 60 mm	$N_{Rec}$	1,0	-	-
		$V_{Rec}$	1,6	-	-
<b>Cracked concrete <sup>b)</sup></b> ≥ C20/25	c ≥ 100 mm	$N_{Rec}$ [kN]	-	0,5	-
		$V_{Rec}$	-	0,5	-
<b>Solid clay brick Mz <sup>c)</sup></b> size: 240x175x113 strength: $f_{c,test} \geq 12$ [N/mm <sup>2</sup> ] density: 1800 [kg/m <sup>3</sup> ]	c ≥ 30 mm	$N_{Rec}$ [kN]	-	0,2	-
		$V_{Rec}$	-	0,3	-
	c ≥ 60 mm	$N_{Rec}$	-	0,2	-
		$V_{Rec}$	-	0,4	-
<b>Solid lime block KS <sup>c)</sup></b> size: 240x175x113 strength: $f_{c,test} \geq 12$ [N/mm <sup>2</sup> ] density: 2000 [kg/m <sup>3</sup> ]	c ≥ 30 mm	$N_{Rec}$ [kN]	-	1,0	-
		$V_{Rec}$	-	0,4	-
	c ≥ 60 mm	$N_{Rec}$	-	1,0	-
		$V_{Rec}$	-	1,1	-
<b>Hollow brick Hlz</b> strength: $f_{c,test} \geq 12$ [N/mm <sup>2</sup> ] density: 800 [kg/m <sup>3</sup> ]	c ≥ 30 mm	$N_{Rec}$ [kN]	-	-	0,1
		$V_{Rec}$	-	-	0,2
	c ≥ 60 mm	$N_{Rec}$	-	-	0,1
		$V_{Rec}$	-	-	0,4
<b>Autoclaved aerated concrete PB2 / PB4 <sup>d)</sup></b> strength: 2 [N/mm <sup>2</sup> ] density: 200 [kg/m <sup>3</sup> ]	c ≥ 30 mm	$N_{Rec}$ [kN]	-	-	0,2
		$V_{Rec}$	-	-	0,1
	c ≥ 60 mm	$N_{Rec}$	-	-	0,2
		$V_{Rec}$	-	-	0,3
<b>Autoclaved aerated concrete PB6</b> strength: 6 [N/mm <sup>2</sup> ] density: 600 [kg/m <sup>3</sup> ]	c ≥ 30 mm	$N_{Rec}$ [kN]	-	-	0,2
		$V_{Rec}$	-	-	0,2
	c ≥ 60 mm	$N_{Rec}$	-	-	0,2
		$V_{Rec}$	-	-	0,6

a) With overall partial safety factor for action  $\gamma = 1,4$ . The partial safety factors for action depend on the type of loading and shall be taken from national regulations.

b) Redundant fastening. See following table for requirements

c) Holes must be drilled using rotary action only (no hammering action)

d) No anchor hole drilling required in PB2 / PB4 aerated concrete

The definition of redundant fastening according to Member States is given in the EN 1992-4 and CEN/TR 17079. In Absence of a definition by a Member States the following default values may be taken.

Minimum number of fixing points	Minimum number of anchors per fixing point	Maximum design load of action $N_{Sd}$ per fixing point <sup>a)</sup>
3	1	2 kN
4	1	3 kN

## Materials

### Mechanical properties

Anchor size	HUS 6 / HUS-S 6	
Nominal tensile strength	$f_{uk}$ [N/mm <sup>2</sup> ]	1000
Yield strength	$f_{yk}$ [N/mm <sup>2</sup> ]	900
Stressed cross-section	$A_s$ [mm <sup>2</sup> ]	5,2
Moment of resistance	$W$ [mm <sup>3</sup> ]	13,8
Design bending resistance	$M^0_{Rk,s}$ [Nm]	11

### Material quality

Part	Material
Screw anchor	Carbon steel, galvanized $\geq 5 \mu\text{m}$

### Anchor dimensions

Anchor size	HUS 6		HUS-S 6
Nominal length of screw	$l_s$ [mm]	35 - 220	100 - 220
Core diameter	$d_k$ [mm]	5,3	5,3
Shaft diameter	$d$ [mm]	7,5	7,5

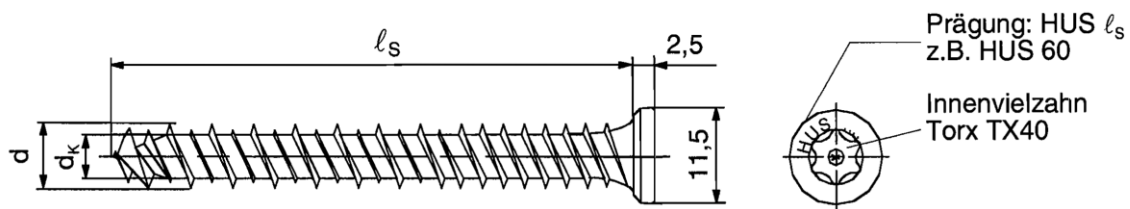

### Head configuration HUS-S

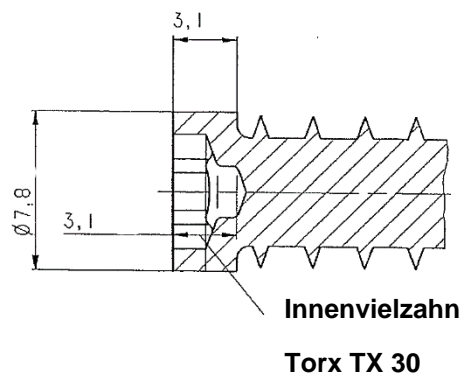

**Setting information**
**Setting details**

Anchor size		6				
Anchor type		HUS				
Base material		Concrete C20/25	Solid brick /Mz 20	Hollow Brick Hz 0.8/12	PB2 / PB4 <sup>c)</sup>	PB6 <sup>c)</sup>
Nominal embedment depth	$h_{nom}$ [mm]	34	44	64	64	64
Nominal diameter of drill bit	$d_0$ [mm]	6	6	6	-	6
Cutting diameter of drill bit	$d_{cut}$ [mm]	6,4	6,4	6,4	-	6,4
Minimum depth of drill hole	$h_1 \geq$ [mm]	50	54 <sup>b)</sup>	64 <sup>a)</sup>	- <sup>b)</sup>	70
Diameter of clearance hole in the fixture to clamp a fixture	$d_f \leq$ [mm]	8,5				
Diameter of clearance hole in the fixture for stand-off applications	$d_f \leq$ [mm]	6,2				
Max. fastening thickness	$t_{fix}$ [mm]	$l_s - h_{nom}$				
Max. installation torque	$T_{inst}$ [mm]	10	4	2	2	2

a) Holes must be drilled using rotary action only (no hammering action)

b) No anchor hole drilling required in PB2/PB4 gas aerated concrete

c) Aerated concrete

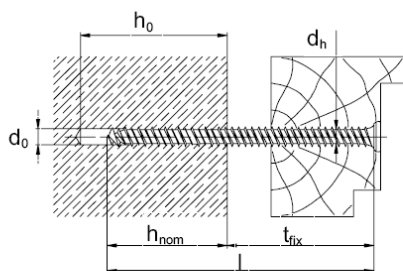

HUS

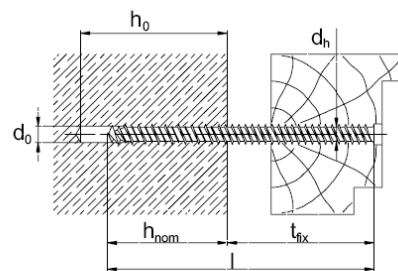

HUS-S

**Installation equipment**

Anchor size	HUS 6	HUS-S 6
Rotary hammer	TE 6 / TE 7	
Drill bit	TE-C3X 6/17	
Recommended setting tool	SID / SIW 121, SID / SIW 144, TKI 2500	
Accessories	S-B TXI 40 bit	S-B TXI 30 bit

### Permissible anchor location in brick and block walls:

- Distance to free edge free edge to solid masonry (HLz and autoclaved aerated gas concrete) units  $\geq 170$  mm
- Distance to free edge free edge to solid masonry (Mz and KS) units  $\geq 200$  mm
- The minimum distance to horizontal and vertical mortar joint ( $c_{min}$ ) is stated in the recommended load table.
- Data applies only to bricks/blocks, there is no test data available for loads in mortar joints. Hilti recommends at least a 50% load reduction or on site testing, if the location of the anchor in relation to the joint (see drawing) can not be specified because of wall plaster or insulation.
- Minimum anchor spacing ( $s_{min}$ ) in one brick/block is  $\geq 2 \cdot c_{min}$

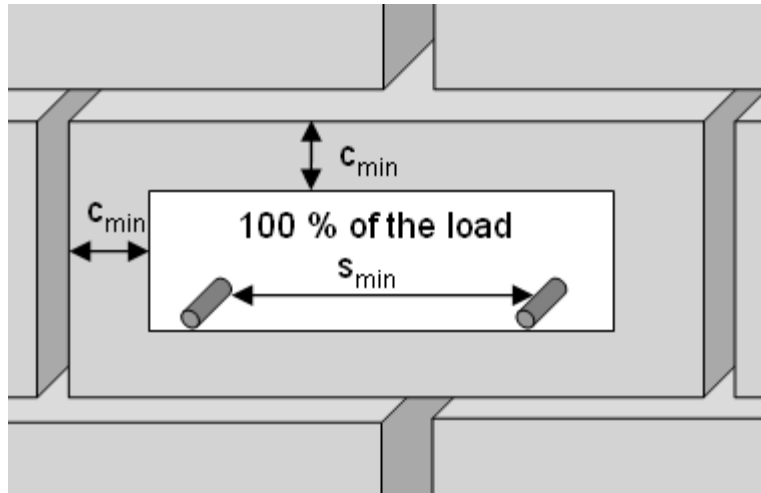

### Setting instructions

\*For detailed information on installation see instruction for use given with the package of the product

Setting instruction for HUS		
<b>1. Drill hole with drill bit</b> 	<b>2. Clean the hole</b> 	<b>3. Install the anchor with an electric screw driver</b> 
Setting instruction for HUS-S		
<b>1. Drill hole with drill bit</b> 	<b>2. Clean the hole</b> 	<b>3. Install the anchor with an electric screwdriver.</b> 



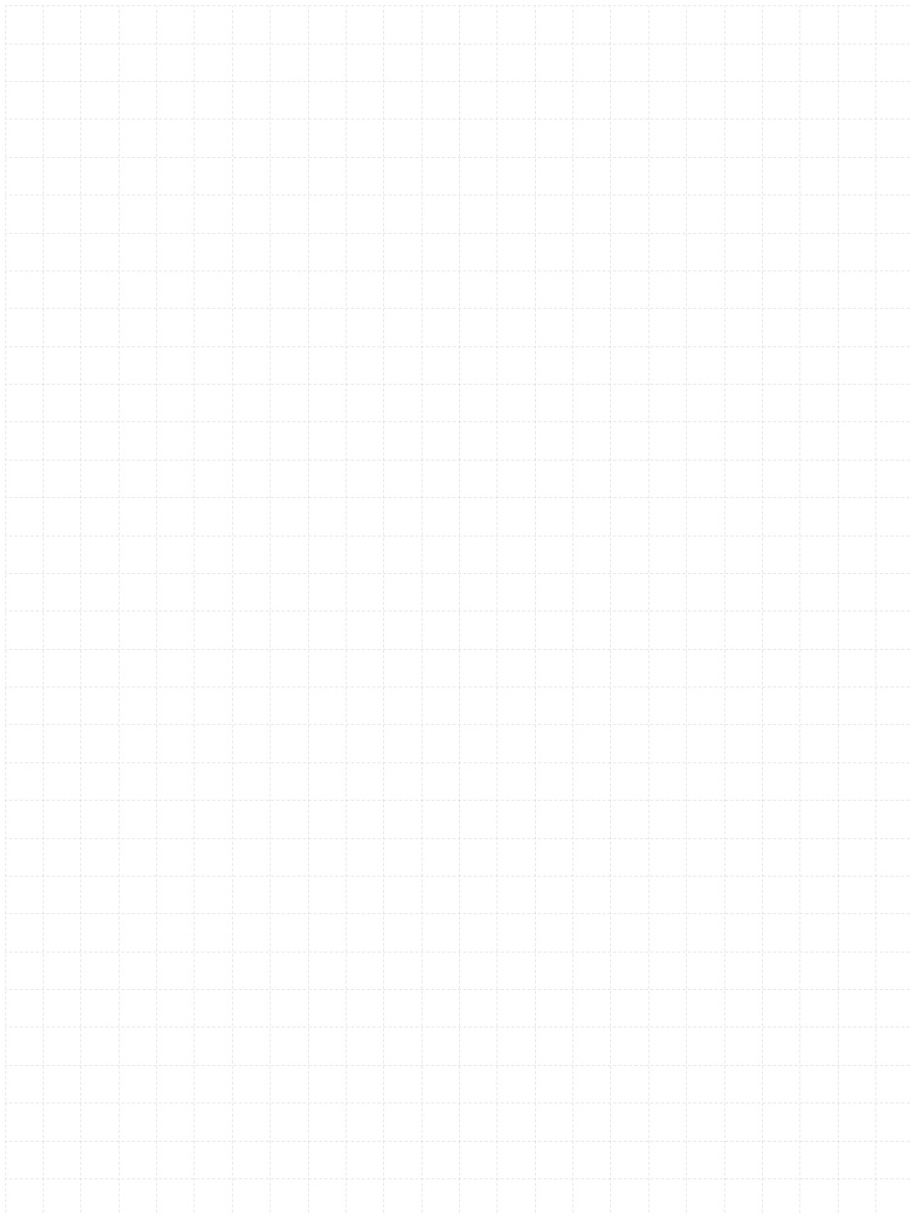







### 3.2.7 HUS3/ HUS-HR/ HUS-CR redundant





# HUS3, HUS-HR / HUS-CR Screw anchor

Ultimate performance screw anchor for redundant fastening applications

Anchor version		Benefits
	HUS3-H/HF (6-10)	<ul style="list-style-type: none"> <li>- Quick and easy setting</li> <li>- Low expansion forces in base materials</li> <li>- Removable</li> <li>- Forged-on washer and hexagon head with no protruding thread</li> <li>- ETA approval for cracked and non cracked concrete and for hollow core slabs</li> <li>- High productivity – less drilling and fewer operations than with conventional anchors</li> <li>- Through-fastening and pre-setting (based on the head configuration)</li> </ul>
	HUS-HR (6)	
	HUS3-C (6-10)	
	HUS-CR (6)	
	HUS3-A (6)	
	HUS3-PL (6)	
	HUS3-P (6)	
	HUS3-PS (6)	
	HUS3-I (6)	
	HUS3-I Flex (6)	

Base material	Load conditions
 <p>Concrete (non-cracked)</p>	 <p>Static / quasi-static</p>
 <p>Concrete (cracked)</p>	
 <p>Prestressed hollow core slabs</p>	
	 <p>Fire resistance</p>

Installation conditions	Other information
 <p>Small edge distance and spacing</p>	 <p>European Technical Assessment</p>
	 <p>CE conformity</p>
	 <p>Corrosion resistance</p>

## Approvals / certificates

Description	Authority / Laboratory	No. / date of issue
European Technical Assessment	DIBt, Berlin	ETA-10/0005 / 2018-11-12
Fire test report	DIBt, Berlin	ETA-10/0005 / 2018-11-12

a) All data given in this section according ETA-10/0005 issue 2018-11-12

## Static and quasi-static resistance

### All data in this section applies to:

- Correct setting (See setting instruction)
- No edge distance and spacing influence
- Minimum base material thickness
- Concrete C 20/25,  $f_{ck,cube} = 25 \text{ N/mm}^2$
- Anchors in redundant fastening

### Anchorage depth

Type	HUS <sup>1)</sup>	HUS <sup>2)</sup>	HUS <sup>3)</sup>
	HR, CR	HR,CR	H,PL,P,PS,I,I-Flex,A,C
Nominal embedment depth $h_{nom}$ [mm]	30	35	35

1) Hilti Technical Data for embedment depth of 30 mm

2) ETA-10/0005 issue 2018-11-12

### Characteristic resistance for all loads directions

Type	HUS <sup>1)</sup>	HUS <sup>2)</sup>		HUS <sup>3)</sup>
	HR,CR	HR,CR		H,PL,P,PS,I,I-Flex,A,C
Fastener size	6 all lengths	6x40 6x45	6x60 6x70	6 all lengths
$35 \text{ mm} \leq c < 80 \text{ mm}$ $F_{Rk}^0$ [kN]	2,0	3,0		2,0
$c > 80 \text{ mm}$ $F_{Rk}^0$ [kN]	2,0	3,5	5,0	3,0

1) Hilti Technical Data for embedment depth of 30 mm

2) ETA-10/0005 issue 2018-11-12

### Design resistance for all loads directions

Type	HUS <sup>1)</sup>	HUS <sup>2)</sup>		HUS <sup>3)</sup>
	HR,CR	HR	CR	H,PL,P,PS,I,I-Flex,A,C
Fastener size	6 all lengths	6x40 6x45	6x60 6x70	6 all lengths
$35 \text{ mm} \leq c < 80 \text{ mm}$ $F_{Rd}^0$ [kN]	1,0	1,4		1,3
$c > 80 \text{ mm}$ $F_{Rd}^0$ [kN]	1,0	1,7	2,4	2,0

1) Hilti Technical Data for embedment depth of 30 mm

2) ETA-10/0005 issue 2018-11-12

### Recommended loads for all load directions

Type	HUS <sup>1)</sup>	HUS <sup>2)</sup>		HUS <sup>3)</sup>
	HR,CR	HR	CR	H,PL,P,PS,I,I-Flex,A,C
Fastener size	6 all lengths	6x40 6x45	6x60 6x70	6 all lengths
$35 \text{ mm} \leq c < 80 \text{ mm}$ $F_{Rec}^0$ [kN]	0,7	1,0		0,9
$c > 80 \text{ mm}$ $F_{Rec}^0$ [kN]	0,7	1,2	1,7	1,4

1) Hilti Technical Data for embedment depth of 30 mm

2) ETA-10/0005 issue 2018-11-12

3) With overall partial safety factor for action  $\gamma = 1,4$ . The partial safety factors for action depend on the type of loading and shall be taken from national regulations

### Requirements for redundant fastening

The definition of redundant fastening according to Member States is given in EN 1992-4 and CEN/TR 17079. In Absence of a definition by a Member State the following default values may be taken.

Minimum number of fixing points	Minimum number of anchors per fixing point	Maximum design load of action $N_{sd}$ per fixing point <sup>a)</sup>
3	1	2 kN
4	1	3 kN

## Fire resistance

### All data in this section applies to:

- Correct setting (See setting instruction)
- No edge distance and spacing influence
- Steel failure
- Minimum base material thickness
- Concrete C 20/25 to C50/60
- Partial safety factor for resistance under fire exposure  $\gamma_{M,fi} = 1,0$  (in absence of other national regulations)

### Anchorage depth

Type	HUS		HUS3 <sup>2)</sup>
	HR	CR	H, P, PS, PL, I, I-Flex, A, C
Nominal embedment depth $h_{nom}$ [mm]	35		

### Characteristic resistance

Type	HUS		HUS3
	HR	CR	H, P, PS, PL, I, I-Flex, A, C
<b>Fire exposure R30</b>			
All load directions $F_{Rk,fi}$ [kN]	0,7	0,2	0,5
<b>Fire exposure R120</b>			
All load directions $F_{Rk,fi}$ [kN]	0,5	0,1	0,4

### Design resistance

Type	HUS		HUS3
	HR	CR	H, P, PS, PL, I, I-Flex, A, C
<b>Fire exposure R30</b>			
All load directions $F_{Rk,fi}$ [kN]	0,7	0,2	0,5
<b>Fire exposure R120</b>			
All load directions $F_{Rk,fi}$ [kN]	0,5	0,1	0,4

For more information about fire resistance please see the full ETA-10/0005 report.

### Requirements for redundant fastening

The definition of redundant fastening according to Member States is given in EN 1992-4 and CEN/TR 17079. In absence of a definition by a Member State the following default values may be taken.		
Minimum number of fixing points	Minimum number of anchors per fixing point	Maximum design load of action $N_{Sd}$ per fixing point <sup>a)</sup>
3	1	2 kN
4	1	3 kN

- a) The value for maximum design load of actions per fastening point  $N_{Sd}$  is valid in general that means all fastening points are considered in the design of the redundant structural system. The value  $N_{Sd}$  may be increased if the failure of one (=most unfavourable) fixing point is taken into account in the design (serviceability and ultimate limit state) of the structural system e.g. suspended ceiling.

**Materials**
**Mechanical properties**

Type			HUS	HUS3
			HR,CR	H,PL,P,PS,I,I-Flex,A,C
Nominal tensile strength	$f_{uk}$	[N/mm <sup>2</sup> ]	1040	930
Stressed cross-section	$A_s$	[mm <sup>2</sup> ]	22,9	26,9
Moment of resistance	$W$	[mm <sup>3</sup> ]	15,5	19,7
Characteristic bending resistance	$M^{0}_{Rk,s}$	[Nm]	19,0	22,0

**Material quality**

Type	Material
HUS3- H,PL,P,PS,I,I-Flex,A,C	Carbon steel, galvanized $\geq 5 \mu\text{m}$
HUS- HR,CR	Stainless steel, grade A4

**Anchor dimensions**

Type			HUS	HUS3							
			HR,CR	H	C	A	PL	P	PS	I	I-Flex
Nominal length	$l_s$	[mm]	40-70	40-120	40-70	35-55	60	40-80	40-60	35-55	55-195
Threaded outer diameter	$d_t$	[mm]	7,6	7,85							
Core diameter	$d_k$	[mm]	5,4	5,85							
Shaft diameter	$d_s$	[mm]	5,8	6,15							
Diameter of integrated washer	$d_i$	[mm]	-	16,5	-	-	-	-	-	-	-
Stressed section	$A_s$	[mm <sup>2</sup> ]	22,9	26,9							

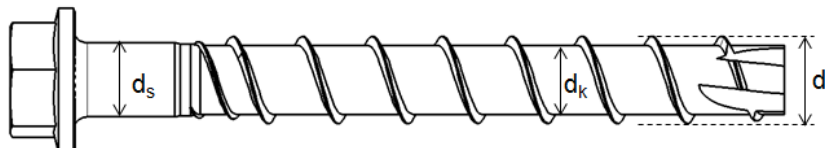
**Special anchor dimensions**

Type			HUS3-C			HUS-CR			HUS3-		
			d6	d8	d10	d6	d8	d10	PL	P	PS
Diameter			d6	d8	d10	d6	d8	d10	d6	d6	d6
Countersunk height	$h_c$	[mm]	4,0	6,3	6,9	4,3	6,3	7,0	-	-	-
Diameter of the countersunk	$d_c$	[mm]	11,5	18	21	11,5	18	21	-	-	-
Pan head diameter	$d_p$	[mm]	-	-	-	-	-	-	21,8	17,6	13,3

**Head configuration**

Type	Head		
HUS3-H 6	Hexagonal head		
HUS-HR 6	Hexagonal head		
HUS3-C 6	Countersunk head		
HUS-CR 6	Countersunk head		
HUS3-A 6	External thread		
HUS3-PL	Pan head (large)		
HUS3-P	Pan head		
HUS3-PS 6	Pan head (small)		
HUS3-I 6	Internal thread		
HUS3-I Flex 6	External thread		

**Setting information**
**Setting details**

Type	HUS		HUS3								
	HR	CR	H	C	A	P	PL	PS	I	I-Flex	
Nominal diameter of drill bit	$d_0$	[mm]	6								
Cutting diameter of drill bit	$d_{cut} \leq$	[mm]	6,40								
Clearance hole diameter	$d_f$	[mm]	9								
Wrench size	SW	[mm]	13	-	13	-	13	-	-	13	13
Countersunk diameter	$d_h$	[mm]	-	11,0	-	11,5	-	-	-	-	-
Torx size	TX	[-]	-	T30	T30	T30	-	T30	T30	T30	-
Installation torque	$T_{inst}$	[mm]	- <sup>1)</sup>	- <sup>1)</sup>	18						
Depth of drill hole in floor/wall position	$h_1 \geq$	[mm]	45 mm								
Depth of drill hole in ceiling position	$h_1 \geq$	[mm]	38 mm								

1) Hand setting in concrete base material not allowed (machine setting only).

**Screw length and maximum thickness of fixture**

Fastener size		6									
Type	Nominal embedment depth [mm]	HUS		HUS3							
		HR	CR	H	C	A	PL	P	PS	I	I-Flex
Length of screw [mm]		$h_{nom}$									
		Thickness of fixture [mm] $t_{fix}$									
35		-	-	-	-	0	-	-	-	0	-
40		-	5	5	5	-	-	5	5	-	-
45		10	-	-	-	-	-	-	-	-	-
55		-	-	-	-	20	-	-	-	20	20
60		25	25	25	25	-	25	25	25	-	-
70		35	35	-	35	-	-	-	-	-	-
80		-	-	45	-	-	-	45	-	-	-
100		-	-	65	-	-	-	-	-	-	-
120		-	-	85	-	-	-	-	-	-	-
135		-	-	-	-	-	-	-	-	-	100
155		-	-	-	-	-	-	-	-	-	120
175		-	-	-	-	-	-	-	-	-	140
195		-	-	-	-	-	-	-	-	-	160

**Installation equipment**

Type	HUS		HUS3							
	HR	CR	H	C	A	PL	P	PS	I	I-Flex
Rotary hammer	TE 6 – TE 7									
Drill bit	TE-CX 6									
Socket wrench insert (H, A, I-type)	S-NSD 13 ½ (L)									
Impact screw driver	Hilti SIW 14-A /Hilti SIW 22-A									

**Setting parameters**

Type			HUS-HR, CR HUS3-H, PL, P, PS, I, I-Flex, A, C
Minimum base material	$h_{min}$	[mm]	80
Minimum spacing	$s_{min}$	[mm]	35
Minimum edge distance	$c_{min}$	[mm]	35(80) <sup>1)</sup>
Critical spacing	$s_{cr}$	[mm]	3 $h_{ef}$
Critical edge distance	$c_{cr}$	[mm]	1,5 $h_{ef}$

- 1) For spacing (edge distance) smaller than critical spacing (critical edge distance) the design loads have to be reduced (see system design resistance).

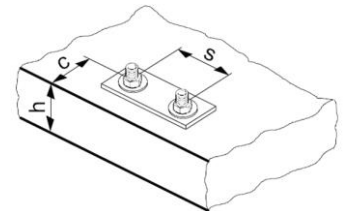
**Setting instructions**

\*For detailed information on installation see instruction for use given with the package of the product

Setting instruction for HUS-HR,CR	
<b>1. Drill hole with the drill bit</b> 	<b>2. Clean hole</b> 
<b>3. Installing the anchor by impact screw driver</b> 	<b>4. Checking</b> 
Setting instruction for HUS3-H, C, I, I-Flex, A, P, PS, PL	
<b>1. Drill hole with drill bit</b> 	<b>2. Clean hole</b> 
<b>3. Installing the anchor by impact screw driver</b> 	<b>4. Checking</b> 

The anchor can be adjusted max. two times.

The total allowed thickness of shims added during the adjustment process is 10 mm.

The final embedment depth after adjustment process must be larger or equal than  $h_{nom2}$  or  $h_{nom3}$ .

**Basic loading data for redundant fastening in prestressed hollow core slabs**
**All data in this section applies to:**

- Correct anchor setting (See setting instruction)
- No edge distance and spacing influence
- Ratio core width/web thickness  $w/e \leq 4,2$
- Concrete C 30/37 to C50/56
- Data for size 6 is according to ETA-10/0005
- Data for size 8 and 10 is according to Hilti technical data

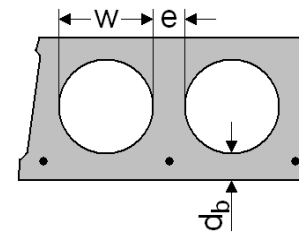
**Requirements for redundant fastening**

The definition of redundant fastening according to Member States is given in the EAD 330747 § 1.2.1. In Absence of a definition by a Member State the following default values may be taken.

Minimum number of fixing points	Minimum number of anchors per fixing point	Maximum design load of action $N_{Sd}$ per fixing point <sup>a)</sup>
3	1	2 kN
4	1	3 kN

- a) The value for maximum design load of actions per fastening point  $N_{Sd}$  is valid in general that means all fastening points are considered in the design of the redundant structural system. The value  $N_{Sd}$  may be increased if the failure of one (=most unfavourable) fixing point is taken into account in the design (serviceability and ultimate limit state) of the structural system e.g. suspended ceiling.

**Characteristic resistance for all load directions**

Type	HUS-HR,CR		HUS-HR, CR			HUS3-H, PL, P, PS, I, I-Flex, A, C		
	6x40, 6x45		6x60, 6x70			6 all lengths		
Bottom flange thickness $d_b$ [mm]	$\geq 25$	$\geq 30$	$\geq 25$	$\geq 30$	$\geq 35$	$\geq 25$	$\geq 30$	$\geq 35$
All load directions $F_{Rk}$ [kN]	1,0	2,0	1,0	2,0	3,0	1,0	2,0	3,0

**Design resistance for all load directions**

Type	HUS-HR,CR		HUS-HR, CR			HUS3-H, PL, P, PS, I, I-Flex, A, C		
	6x40, 6x45		6x60, 6x70			6 all lengths		
Bottom flange thickness $d_b$ [mm]	$\geq 25$	$\geq 30$	$\geq 25$	$\geq 30$	$\geq 35$	$\geq 25$	$\geq 30$	$\geq 35$
All load directions $F_{Rd}$ [kN]	0,7	1,3	0,7	1,3	2,0	1,0	1,3	2,0

**Recommended load for all load directions<sup>a)</sup>**

Type	HUS-HR,CR		HUS-HR, CR			HUS3-H, PL, P, PS, I, I-Flex, A, C		
	6x40, 6x45		6x60, 6x70			6 all lengths		
Bottom flange thickness $d_b$ [mm]	$\geq 25$	$\geq 30$	$\geq 25$	$\geq 30$	$\geq 35$	$\geq 25$	$\geq 30$	$\geq 35$
All load directions $F_{Rec}$ [kN]	0,5	1,0	0,5	1,0	1,4	1,0	1,0	1,4

- a) With overall partial safety factor for action  $\gamma = 1,4$ . The partial safety factors for action depend on the type of loading and shall be taken from national regulations.



**Characteristic resistance for all load directions**

Anchor size		8	10
Type		HUS3-C, H, HF	
Bottom flange thickness	$d_b \geq$ [mm]	30	30
All load directions		$F_{Rk}$ [kN]	2,0

**Design resistance for all load directions**

Anchor size		8	10
Type		HUS3-C, H, HF	
Bottom flange thickness	$d_b \geq$ [mm]	30	30
All load directions		$F_{Rd}$ [kN]	1,3

**Recommended loads for all load directions**

Anchor size		8	10
Type		HUS3-C, H, HF	
Bottom flange thickness	$d_b \geq$ [mm]	30	30
All load directions <sup>a)</sup>		$F_{Rec}$ [kN]	0,95

a) With overall partial safety factor for action  $\gamma = 1,4$ . The partial safety factors for action depend on the type of loading and shall be taken from national regulations.

**Setting information**
**Setting details**

Anchor size		6		
Type		HUS <sup>1)</sup>		HUS-HR, CR <sup>2)</sup> HUS3-H, PL, P, PS, I, I-Flex, A, C
		HR	CR	
Effective anchorage depth	$h_{ef}$ [mm]	25		
Bottom flange thickness	$d_b \geq$ [mm]	25		
Nominal diameter of drill bit	$d_0$ [mm]	6		
Cutting diameter of drill bit	$d_{cut} \leq$ [mm]	6,4		
Nominal depth of drill hole <sup>4)</sup>	$h_1 \geq$ [mm]	38		
Clearance hole diameter	$d_f$ [mm]	9		
Distance between anchor and prestressing steel	$a_p \geq$ [mm]	50		
Core distance	$l_c \geq$ [mm]	100		
Pre-stressing steel distance	$l_p \geq$ [mm]	100		
Installation torque	$T_{inst}$ [mm]	- <sup>3)</sup>		18

1) Hilti Technical Data for embedment depth of 30 mm

2) ETA-10/0005 issue 2018-11-12

3) Hand setting in concrete base material not allowed (machine setting only)

4) Nominal depth of drill hole may be deeper than bottom flange thickness

Anchor size		8	
Type		HUS3-C, H, HF	HUS3-C, H, HF
Effective anchorage depth	$h_{ef}$ [mm]	30	30
Bottom flange thickness	$d_b \geq$ [mm]	30	30
Nominal diameter of drill bit	$d_0$ [mm]	8	10
Cutting diameter of drill bit	$d_{cut} \leq$ [mm]	8,45	10,45
Nominal depth of drill hole <sup>1)</sup>	$h_1 \geq$ [mm]	40	40
Clearance hole diameter	$d_f$ [mm]	12	14
Distance between anchor and prestressing steel	$a_p \geq$ [mm]	50	50
Core distance	$l_c \geq$ [mm]	100	100
Pre-stressing steel distance	$l_p \geq$ [mm]	100	100

1) Nominal depth of drill hole may be deeper than bottom flange thickness

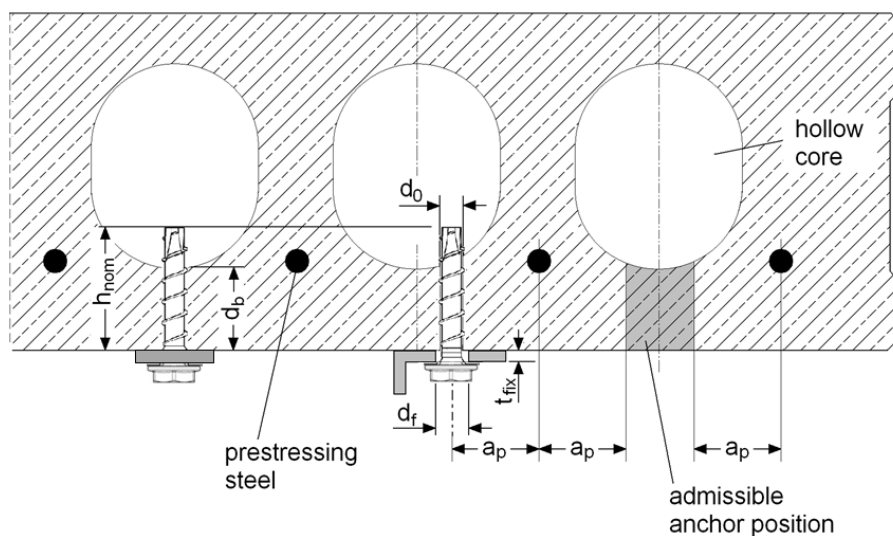

### Screw length and thickness of fixture used in precast pre-stressed hollow core slabs for size 6

Anchor size		6									
Type		HUS		HUS3							
		HR	CR	H	C	A	PL	P	PS	I	I-Flex
Length of screw [mm]	Nominal embedment depth [mm]	Thickness of fixture [mm] $t_{fix}$									
35		-	-	-	-	0	-	-	-	0	-
40		-	-	5	5	-	-	5	5	-	-
45		15	-	-	-	-	-	-	-	-	-
55		-	-	-	-	20	-	-	-	20	20
60		5-25	5-25	5-25	5-25	-	5-25	5-25	5-25	-	-
70		15-35	15-35	-	15-35	-	-	-	-	-	-
80		-	-	25-45	-	-	-	25-45	-	-	-
100		-	-	45-65	-	-	-	-	-	-	-
120		-	-	65-85	-	-	-	-	-	-	-
135		-	-	-	-	-	-	-	-	-	80-100
155		-	-	-	-	-	-	-	-	-	100-120
175		-	-	-	-	-	-	-	-	-	120-140
195		-	-	-	-	-	-	-	-	-	140-160

**Screw length and thickness of fixture used in precast pre-stressed hollow core slabs for size 8**

Anchor Type	Size	Length [mm]	d <sub>b</sub> =30 [mm]		d <sub>b</sub> =35 [mm]		d <sub>b</sub> =40 [mm]		d <sub>b</sub> =50 [mm]	
	[mm]		t <sub>fix,min</sub> [mm]	t <sub>fix,max</sub> [mm]	t <sub>fix,min</sub> [mm]	t <sub>fix,max</sub> [mm]	t <sub>fix,min</sub> [mm]	t <sub>fix,max</sub> [mm]	t <sub>fix,min</sub> [mm]	t <sub>fix,max</sub> [mm]
HUS3-H	8	55	5	15	5	10	5	5	5	5
		65	5	25	5	20	5	15	5	5
		75	5	35	5	30	5	25	5	15
		85	15	45	15	40	15	35	15	25
		100	30	60	30	55	30	50	30	40
		120	50	80	50	75	50	70	50	60
		150	80	110	80	105	80	100	80	90
HUS3-HF	8	65	5	25	5	20	5	15	5	5
		75	5	35	5	30	5	25	5	15
		85	15	45	15	40	15	35	15	25
		100	30	60	30	55	30	50	30	40
HUS3-C	8	65	15	25	15	20	15	15	15	5
		75	15	35	15	30	15	25	15	15
		85	15	45	15	40	15	35	15	25
HUS3-H	10	60	5	15	5	10	5	5	5	5
		70	15	25	15	20	15	15	15	5
		80	5	35	5	30	5	25	5	15
		90	5	45	5	40	5	35	5	25
		100	15	55	15	50	15	45	15	35
		110	25	65	25	60	25	55	25	45
		150	65	105	65	100	65	95	65	85
HUS3-HF	10	60	5	15	5	10	5	5	5	5
		80	5	35	5	30	5	25	5	15
		100	15	55	15	50	15	45	15	35
		110	25	65	25	60	25	55	25	45
HUS3-C	10	70	15	25	15	20	15	15	15	10
		90	15	45	15	40	15	35	15	25
		100	15	55	15	50	15	45	15	35

**Anchor spacing and edge distance**

Type			HUS-HR, CR HUS3-H, PL,P, PS, I, I-Flex, A, C
Minimum edge distance	$c_{min} \geq$	[mm]	100
Minimum anchor spacing	$s_{min} \geq$	[mm]	100
Minimum distance between anchor groups	$a_{min} \geq$	[mm]	100

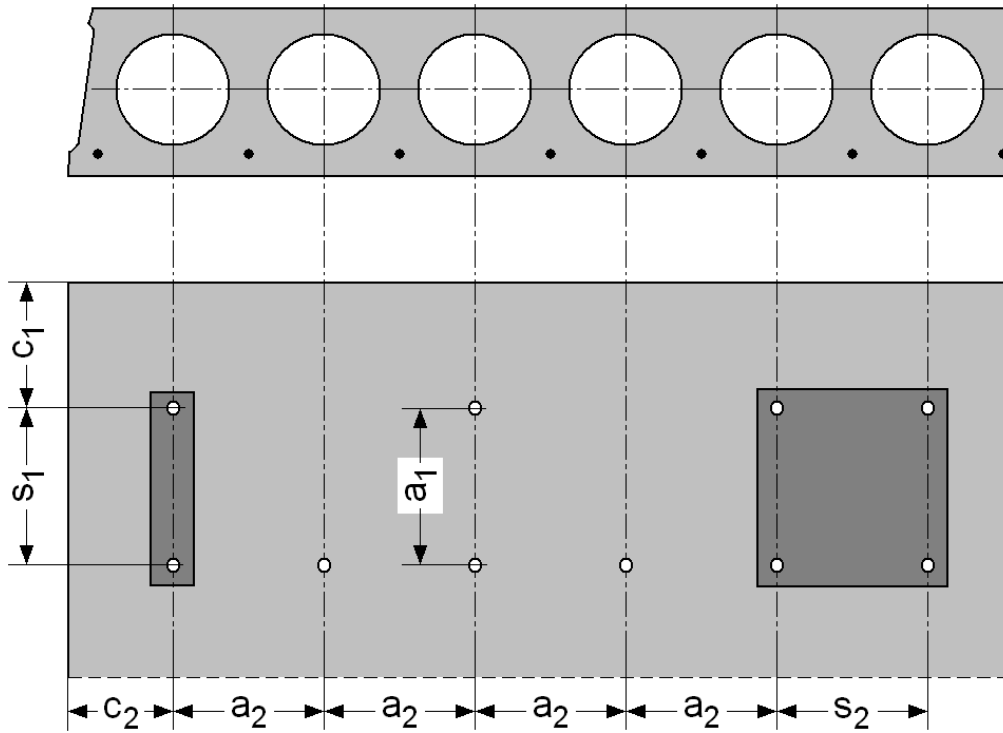

$c_1, c_2$  edge distance  
 $s_1, s_2$  Anchor spacing  
 $a_1, a_2$  Distances between anchor groups

**Setting instructions**

\*For detailed information on installation see instruction for use given with the package of the product

**Installation in hollow core slabs**

**1. Checking the anchor with tube Hilti HSB**

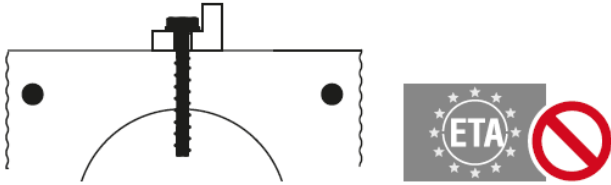

**2. Positioning pre-stressed steel**

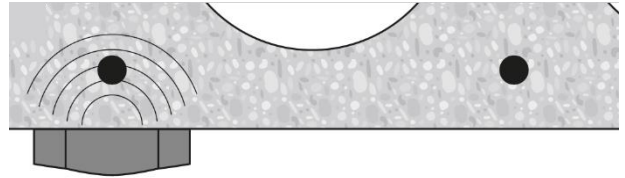

**3. Marking pre-stressed steel position**

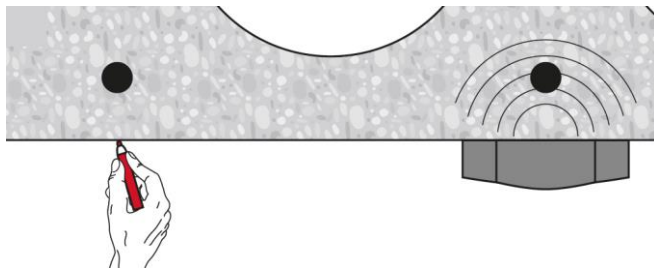

**4. Marking pre-stressed steel position**

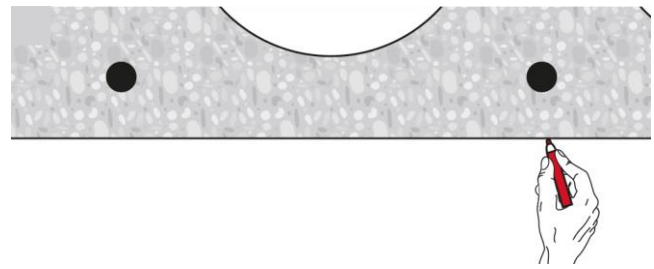

**5. Drilling**

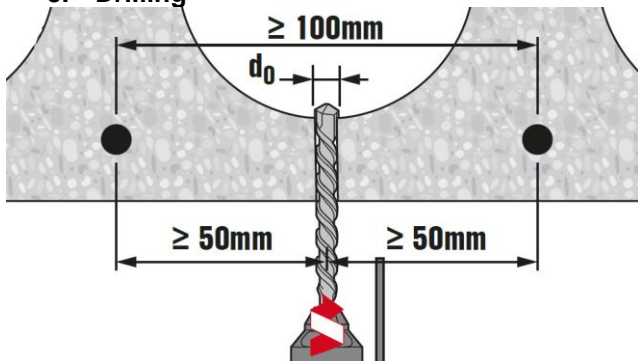

**6. Setting the anchor**

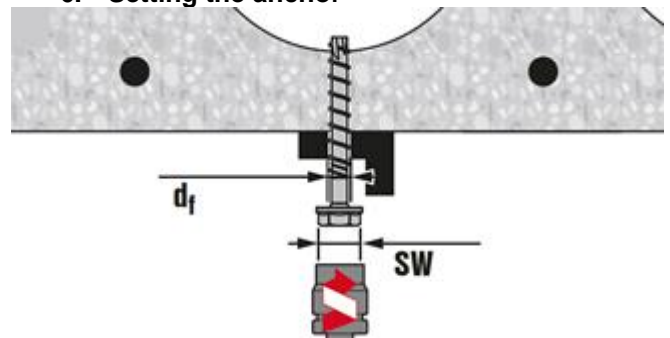

**7. Setting the anchor**

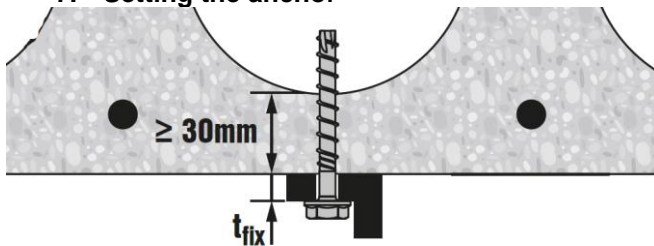

**8. Checking**

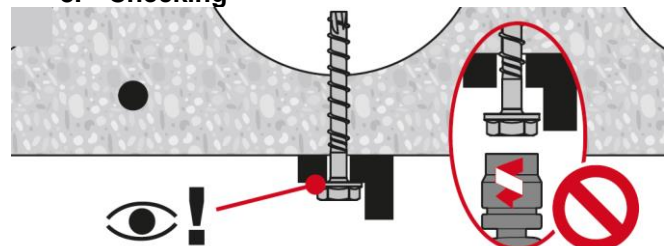

### 3.3 Undercut anchors

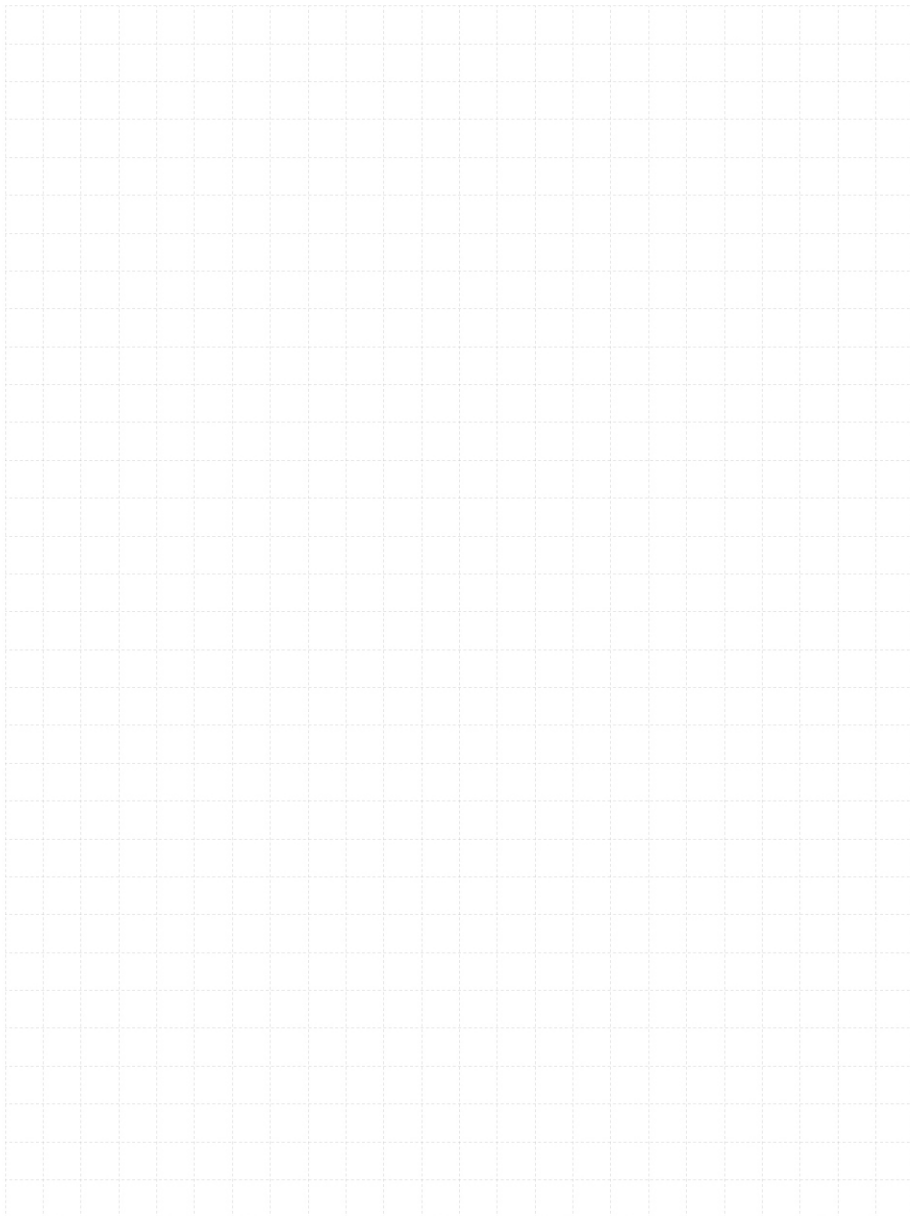

#### 3.3.1 HDA













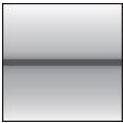

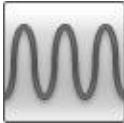

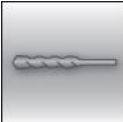
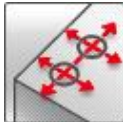
<http://hilti.to/traceable-fastener>

# HDA Undercut anchor

## Ultimate-performance undercut anchor for dynamic loads

Anchor version	Benefits
 <p>HDA-P HDA-PR HDA-PF Anchor for pre-setting (M10-M20)</p>	<ul style="list-style-type: none"> <li>- Safe and high performance structural seismic design with ETA C1 and C2</li> <li>- Mechanical interlock (undercut)</li> <li>- Low expansion force (thus small edge distance / spacing)</li> <li>- Self undercutting (without special undercutting tool)</li> <li>- Performance of a headed stud</li> <li>- Complete system (anchor, stop drill bit, setting tool, drill hammer)</li> <li>- Setting mark on anchor for control (easy and safe)</li> <li>- Completely removable</li> </ul>
 <p>HDA-T HDA-TR HDA-TF Anchor for through-fastening (M10-M20)</p>	

Base material	Load conditions
 <p>Concrete non-cracked</p>  <p>Concrete (cracked)</p>	 <p>Static/ quasi-static</p>  <p>Seismic ETA-C1, C2</p>  <p>Fatigue</p>  <p>Shock</p>  <p>Fire resistance</p>
Installation conditions	Other information
 <p>Hammer drilled holes</p>  <p>Small edge distance and spacing</p>  <p>Performance of a headed stud</p>	 <p>Tracefast</p>  <p>European Technical Assessment</p>  <p>CE conformity</p>  <p>PROFIS Engineering design Software</p>  <p>Nuclear power plant approval</p>  <p>A4 316 Corrosion resistance</p>

### Approvals / certificates

Description	Authority / Laboratory	No. / date of issue
European Technical Assessment <sup>a)</sup>	CSTB, Paris	ETA-99/0009 / 2015-01-06
European Technical Assessment <sup>a)</sup>	DIBt, Berlin	ETA-18/0974 / 2019-06-20
ICC-ES report incl. seismic <sup>b)</sup>	ICC evaluation service	ESR 1546 / 2014-02-01
Shockproof fastenings in civil defence installations	Federal Office for Civil Protection, Bern	BZS D 09-601/ 2009-10-21
Nuclear power plants	DIBt, Berlin	Z-21.1-1987 / 2014-07-22
Fire assessment report	IBMB MPA, Braunschweig	2103/508/21 / 2021-12-06

a) All data given in this section according ETA-99/0009, issue 2015-01-06, and ETA-18/0974, issue 2019-06-20.

b) For more details on Technical Data according to ICC please consult the relevant HNA FTM.

<http://hilti.to/traceable-fastener>

### Static and quasi-static resistance (for a single anchor)

#### All data in this section applies to:

- Correct setting (See setting instruction)
- No edge distance and spacing influence
- Steel failure
- Minimum base material thickness
- Concrete C 20/25,  $f_{ck,cube} = 25 \text{ N/mm}^2$

#### Effective anchorage depth for static

Anchor size	M10	M12	M16	M20
Effective anchorage depth $h_{ef}$ [mm]	100	125	190	250

#### Characteristic resistance

Anchor size	M10	M12	M16	M20 <sup>a)</sup>													
<b>Non-cracked concrete</b>																	
Tension HDA-P(F), HDA-T(F) <sup>b)</sup> $N_{Rk}$ [kN]	46	67	126	192													
	46	67	126	-													
<b>Cracked concrete</b>																	
Tension HDA-P(F), HDA-T(F) <sup>b)</sup> $N_{Rk}$ [kN]	25	35	75	95													
	25	35	75	-													
<b>Non-cracked and cracked concrete</b>																	
Shear	HDA-T(F) <sup>b)</sup>	$t_{fix,min}$ [mm]	10≤	15≤	10≤	15≤	20≤	30≤	15≤	20≤	25≤	30≤	35≤	20≤	25≤	40≤	55≤
		$t_{fix,max}$ [mm]	<15	≤20	<15	<20	<30	≤50	<20	<25	<30	<35	≤60	<25	<40	<55	≤100
		$V_{Rk}$ [kN]	65 <sup>c)</sup>	70	80	80	100	100	140 <sup>c)</sup>	140	155	170	190	205	205	235	250
	HDA-TR	$t_{fix,min}$ [mm]	10≤	15≤	10≤	15≤	20≤	30≤	15≤	20≤	25≤	30≤	35≤	-			
		$t_{fix,max}$ [mm]	<15	≤20	<15	<20	<30	≤50	<20	<25	<30	<35	≤60	-			
		$V_{Rk}$ [kN]	71 <sup>c)</sup>	71	87	87	94	109	152	152	158	158	170	-			
	HDA-P(F) <sup>b)</sup> $V_{Rk}$ [kN]		22		30		62		92								
	HDA-PR $V_{Rk}$ [kN]		23		34		63										

a) HDA M20: only galvanized 5μm version is available.

b) HDA-PF and HDA-TF: anchors are not covered by ETA-99/0009.

c) With use of centering washer ( $t=5\text{mm}$ ) only.



<http://hilti.to/traceable-fastener>
**Design resistance**

Anchor size		M10	M12	M16	M20 <sup>a)</sup>													
<b>Non-cracked concrete</b>																		
Tension	HDA-P(F), HDA-T(F) <sup>b)</sup>	N <sub>Rd</sub> [kN]	30,7	44,7	84,0	128,0												
	HDA-PR, HDA-TR		28,8	41,9	78,8	-												
<b>Cracked concrete</b>																		
Tension	HDA-P(F), HDA-T(F) <sup>b)</sup>	N <sub>Rd</sub> [kN]	16,7	23,3	50,0	63,3												
	HDA-PR, HDA-TR		16,7	23,3	50,0	-												
<b>Non-cracked and cracked concrete</b>																		
Shear	HDA-T(F) <sup>b)</sup>	t <sub>fix,min</sub> [mm]	10≤	15≤	10≤	15≤	20≤	30≤	15≤	20≤	25≤	30≤	35≤	20≤	25≤	40≤	55≤	
		t <sub>fix,max</sub> [mm]	<15	≤20	<15	<20	≤30	≤50	<20	<25	<30	<35	≤60	<25	<40	<55	≤100	
		V <sub>Rd</sub> [kN]	43,3 <sup>c)</sup>	46,7	53,3 <sup>c)</sup>	53,3	66,7	66,7	93,3 <sup>c)</sup>	93,3	103,3	113,3	126,7	136,7 <sup>c)</sup>	136,7	156,7	166,7	
	HDA-TR	t <sub>fix,min</sub> [mm]	10≤	15≤	10≤	15≤	20≤	30≤	15≤	20≤	25≤	30≤	35≤	-				
		t <sub>fix,max</sub> [mm]	<15	≤20	<15	<20	<30	≤50	<20	<25	<30	<35	≤60	-				
		V <sub>Rd</sub> [kN]	53,4 <sup>c)</sup>	53,4	65,4 <sup>c)</sup>	65,4	70,7	82,0	114,3 <sup>c)</sup>	114,3	118,8	118,8	127,8	-				
	HDA-P(F) <sup>b)</sup>		V <sub>Rd</sub> [kN]	17,6	24,0			49,6			73,6							
	HDA-PR			17,3	25,6			47,4			-							

- a) HDA M20: only galvanized 5µm version is available.  
 b) HDA-PF and HDA-TF: anchors are not covered by ETA-99/0009.  
 c) With use of centering washer (t=5mm) only.

**Recommended loads <sup>d)</sup>**

Anchor size		M10	M12	M16	M20 <sup>a)</sup>													
<b>Non-cracked concrete</b>																		
Tension	HDA-P(F), HDA-T(F) <sup>b)</sup>	N <sub>Rec</sub> [kN]	21,9	31,9	60,0	91,4												
	HDA-PR, HDA-TR		20,5	29,9	56,3	-												
<b>Cracked concrete</b>																		
Tension	HDA-P(F), HDA-T(F) <sup>b)</sup>	N <sub>Rec</sub> [kN]	11,9	16,7	35,7	45,2												
	HDA-PR, HDA-TR		11,9	16,7	35,7	-												
<b>Non-cracked and cracked concrete</b>																		
Shear	HDA-T(F) <sup>b)</sup>	t <sub>fix,min</sub> [mm]	10≤	15≤	10≤	15≤	20≤	30≤	15≤	20≤	25≤	30≤	35≤	20≤	25≤	40≤	55≤	
		t <sub>fix,max</sub> [mm]	<15	≤20	<15	<20	≤30	≤50	<20	<25	<30	<35	≤60	<25	<40	<55	≤100	
		V <sub>Rk</sub> [kN]	31 <sup>c)</sup>	31	38 <sup>c)</sup>	38	38	38	67 <sup>c)</sup>	67	74	81	90	98 <sup>c)</sup>	98	112	119	
	HDA-TR	t <sub>fix,min</sub> [mm]	10≤	15≤	10≤	15≤	20≤	30≤	15≤	20≤	25≤	30≤	35≤	-				
		t <sub>fix,max</sub> [mm]	<15	≤20	<15	<20	<30	≤50	<20	<25	<30	<35	≤60	-				
		V <sub>Rk</sub> [kN]	38 <sup>c)</sup>	38	47 <sup>c)</sup>	47	50	59	82 <sup>c)</sup>	82	85	85	91	-				
	HDA-P(F) <sup>b)</sup>		V <sub>Rec</sub> [kN]	12,6	17,1			35,4			52,6							
	HDA-PR			12,3	18,2			33,8			-							

- a) HDA M20: only galvanized 5µm version is available.  
 b) HDA-PF and HDA-TF: anchors are not covered by ETA-99/0009  
 c) With use of centering washer (t=5mm) only  
 d) With overall partial safety factor for action  $\gamma_F = 1,4$ . The partial safety factors for action depend on the type of loading.

<http://hilti.to/traceable-fastener>

## Seismic resistance

### All data in this section applies to:

- Correct setting (See setting instruction with a drilling hammer)
- No edge distance and spacing influence
- Steel failure
- Minimum base material thickness
- Concrete C 20/25,  $f_{ck,cube} = 25 \text{ N/mm}^2$
- $\alpha_{gap} = 1,0$  (using Hilti seismic filling set)

### Effective anchorage depth for seismic C2 and C1

Anchor size	M10	M12	M16	M20
Effective anchorage depth $h_{ef}$ [mm]	100	125	190	250

### Characteristic resistance in case of seismic performance category C2

Anchor size	M10	M12	M16	M20 <sup>a)</sup>														
Tension HDA-P, HDA-T $N_{Rk,seis}$ [kN]	25	35	75	95														
	25	35	75	-														
Shear HDA-T $t_{fix,min}$ [mm]	10 $\leq$	15 $\leq$	20 $\leq$	30 $\leq$	15 $\leq$	20 $\leq$	25 $\leq$	30 $\leq$	35 $\leq$	20 $\leq$	25 $\leq$	40 $\leq$	55 $\leq$					
	$t_{fix,max}$ [mm]	<15	$\leq$ 20	<15	<20	$\leq$ 30	$\leq$ 50	<20	<25	<30	<35	$\leq$ 60	<25	<40	<55	$\leq$ 100		
	$V_{Rk}$ [kN]	39	42	56	56	70	70	84	84	93	102	114	144	144	165	175		
	HDA-TR $t_{fix,min}$ [mm]	10 $\leq$	15 $\leq$	10 $\leq$	15 $\leq$	20 $\leq$	30 $\leq$	15 $\leq$	20 $\leq$	25 $\leq$	30 $\leq$	35 $\leq$	-					
		$t_{fix,max}$ [mm]	<15	$\leq$ 20	<15	<20	<30	$\leq$ 50	<20	<25	<30	<35	$\leq$ 60	-				
		$V_{Rk}$ [kN]	43	43	61	61	66	76	91	91	95	95	102	-				
HDA-P HDA-PR $V_{Rk,seis}$ [kN]	20	24		56				83										
	21	27		57				-										

a) HDA M20: only galvanized 5 $\mu$ m version is available

### Design resistance in case of seismic performance category C2

Anchor size	M10	M12	M16	M20 <sup>a)</sup>														
Tension HDA-P, HDA-T $N_{Rd,seis}$ [kN]	16,7	23,3	50	63,3														
	16,7	23,3	50	-														
Shear HDA-T $t_{fix,min}$ [mm]	10 $\leq$	15 $\leq$	20 $\leq$	30 $\leq$	15 $\leq$	20 $\leq$	25 $\leq$	30 $\leq$	35 $\leq$	20 $\leq$	25 $\leq$	40 $\leq$	55 $\leq$					
	$t_{fix,max}$ [mm]	<15	$\leq$ 20	<15	<20	$\leq$ 30	$\leq$ 50	<20	<25	<30	<35	$\leq$ 60	<25	<40	<55	$\leq$ 100		
	$V_{Rk}$ [kN]	26	28	37,3	37,3	46,7	46,7	56	56	62	68	74,7	96	96	110	116,7		
	HDA-TR $t_{fix,min}$ [mm]	10 $\leq$	15 $\leq$	10 $\leq$	15 $\leq$	20 $\leq$	30 $\leq$	15 $\leq$	20 $\leq$	25 $\leq$	30 $\leq$	35 $\leq$	-					
		$t_{fix,max}$ [mm]	<15	$\leq$ 20	<15	<20	<30	$\leq$ 50	<20	<25	<30	<35	$\leq$ 60	-				
		$V_{Rk}$ [kN]	32,3	32,3	45,9	45,9	49,6	57,1	68,4	68,4	71,4	71,4	76,7	-				
HDA-P HDA-PR $V_{Rd,seis}$ [kN]	16	19,2		44,8				66,4										
	15,8	20,3		42,9				-										

a) HDA M20: only galvanized 5 $\mu$ m version is available

<http://hilti.to/traceable-fastener>
**Characteristic resistance in case of seismic performance category C1**

Anchor size				M10				M12				M16				M20 <sup>a)</sup>			
Tension	HDA-P, HDA-T	$N_{Rk,seis}$ [kN]		41,5		58		108,7				164							
	HDA-PR, HDA-TR			41,5		58		108,7				-							
Shear	HDA-T	$t_{fix,min}$ [mm]		10≤	15≤	10≤	15≤	20≤	30≤	15≤	20≤	25≤	30≤	35≤	20≤	25≤	40≤	55≤	
		$t_{fix,max}$ [mm]		<15	≤20	<15	<20	≤30	≤50	<20	<25	<30	<35	≤60	<25	<40	<55	≤100	
		$V_{Rk}$ [kN]		65	70	80	80	100	100	140	140	155	170	190	205	205	235	250	
	HDA-TR	$t_{fix,min}$ [mm]		10≤	15≤	10≤	15≤	20≤	30≤	15≤	20≤	25≤	30≤	35≤	-				
		$t_{fix,max}$ [mm]		<15	≤20	<15	<20	<30	≤50	<20	<25	<30	<35	≤60	-				
		$V_{Rk}$ [kN]		71	71	87	87	94	109	152	152	158	158	170	-				
	HDA-P	$V_{Rk,seis}$ [kN]		22		30		62				92							
	HDA-PR			23		34		63				-							

a) HDA M20: only galvanized 5µm version is available

**Design resistance in case of seismic performance category C1**

Anchor size				M10				M12				M16				M20 <sup>a)</sup>			
Tension	HDA-P, HDA-T	$N_{Rd,seis}$ [kN]		27,7		38,7		72,5				109,4							
	HDA-PR, HDA-TR			27,7		38,7		72,5				-							
Shear	HDA-T	$t_{fix,min}$ [mm]		10≤	15≤	10≤	15≤	20≤	30≤	15≤	20≤	25≤	30≤	35≤	20≤	25≤	40≤	55≤	
		$t_{fix,max}$ [mm]		<15	≤20	<15	<20	≤30	≤50	<20	<25	<30	<35	≤60	<25	<40	<55	≤100	
		$V_{Rd}$ [kN]		43,3	46,7	53,3	53,3	66,7	66,7	93,3	93,3	103,3	113,3	126,7	136,7	136,7	156,7	166,7	
	HDA-TR	$t_{fix,min}$ [mm]		10≤	15≤	10≤	15≤	20≤	30≤	15≤	20≤	25≤	30≤	35≤	-				
		$t_{fix,max}$ [mm]		<15	≤20	<15	<20	<30	≤50	<20	<25	<30	<35	≤60	-				
		$V_{Rd}$ [kN]		53,1	53,1	65,4	65,4	70,7	74,2	114,3	114,3	118,8	118,8	127,8	-				
	HDA-P	$V_{Rd,seis}$ [kN]		17,6		24		49,6				73,6							
	HDA-PR			17,3		25,6		47,4				-							

a) HDA M20: only galvanized 5µm version is available

<http://hilti.to/traceable-fastener>

## Fatigue resistance

### All data in this section applies to:

- Correct setting using Hilti filling set (See setting instruction)
- No edge distance and spacing influence
- Minimum base material thickness
- Cracked and uncracked concrete C20/25,  $f_c = 20 \text{ N/mm}^2$

### Effective anchorage depth

Anchor size			M10	M12	M16	M20
Effective anchorage depth	$h_{ef}$	[mm]	100	125	190	250

### Characteristic resistance

Anchor size				M10	M12	M16	M20
<b>Non-cracked concrete</b>							
Tension	HDA-P	$\Delta N_{Rk,0,\infty}$	[kN]	9,2	16,3	22,7	26,7
	HDA-T			9,2	16,3	22,7	26,7
Shear	HDA-P	$\Delta V_{Rk,0,\infty}$	[kN]	2,5	6,0	9,0	17,5
	HDA-T			8,5	15,0	23,0	17,5
<b>Cracked concrete</b>							
Tension	HDA-P	$\Delta N_{Rk,0,\infty}$	[kN]	9,2	16,3	22,7	26,7
	HDA-T			9,2	16,3	22,7	26,7
Shear	HDA-P	$\Delta V_{Rk,0,\infty}$	[kN]	2,5	6,0	9,0	17,5
	HDA-T			8,5	15,0	23,0	17,5

### Design resistance

Anchor size				M10	M12	M16	M20
<b>Non-cracked concrete</b>							
Tension	HDA-P	$\Delta N_{Rd,0,\infty}$	[kN]	6,8	12,1	16,8	19,8
	HDA-T			6,8	12,1	16,8	19,8
Shear	HDA-P	$\Delta V_{Rd,0,\infty}$	[kN]	1,9	4,4	6,7	13,0
	HDA-T			6,3	11,1	17,0	13,0
<b>Cracked concrete</b>							
Tension	HDA-P	$\Delta N_{Rd,0,\infty}$	[kN]	6,8	12,1	16,8	19,8
	HDA-T			6,8	12,1	16,8	19,8
Shear	HDA-P	$\Delta V_{Rd,0,\infty}$	[kN]	1,9	4,4	6,7	13,0
	HDA-T			6,3	11,1	17,0	13,0

For more information about different failure modes under fatigue load please see the full ETA-99/0009 report.



### Characteristic Wöhler curve under tension fatigue load

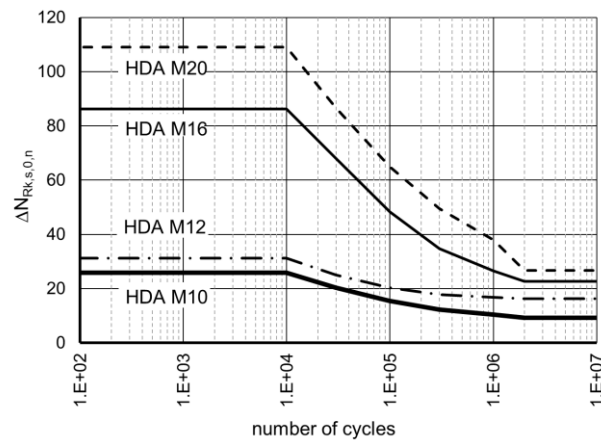

### Characteristic Wöhler curve under shear fatigue load

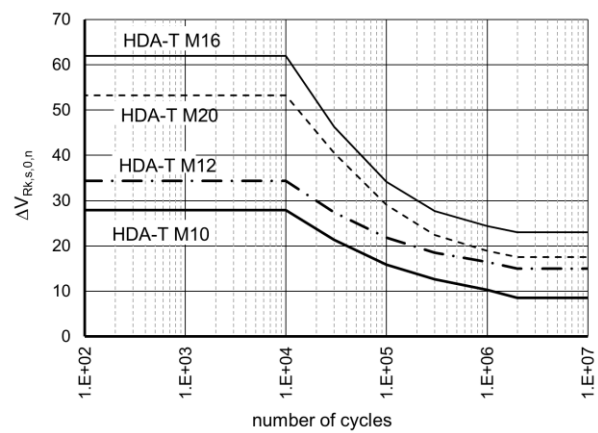
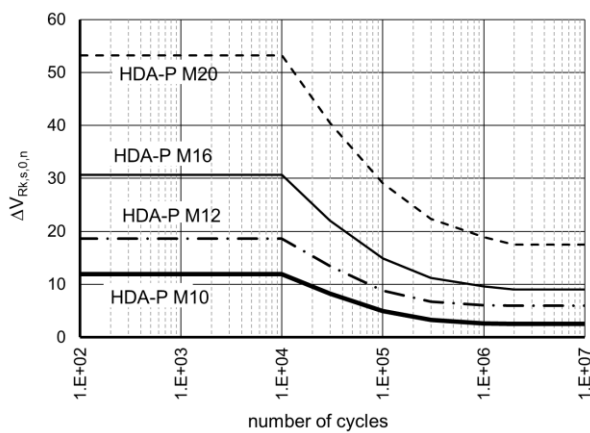

## Materials

### Mechanical properties of HDA

Anchor size	HDA-P(F), HDA-T(F)				HDA-PR, HDA-TR			
	M10	M12	M16	M20 <sup>a)</sup>	M10	M12	M16	
<b>Anchor bolt</b>								
Nominal tensile strength	$f_{uk}$	[N/mm <sup>2</sup> ]						
Yield strength	$f_{yk}$	[N/mm <sup>2</sup> ]						
Stressed cross-section	$A_s$	[mm <sup>2</sup> ]						
Moment of resistance	$W_{el}$	[mm <sup>3</sup> ]						
Characteristic bending resistance without sleeve	$M^0_{Rk,s,b)}$	[Nm]						
<b>Anchor sleeve</b>								
Nominal tensile strength	$f_{uk}$	[N/mm <sup>2</sup> ]						
Yield strength	$f_{yk}$	[N/mm <sup>2</sup> ]						

a) HDA M20: only a galvanized 5 $\mu$ m version is available

b) The recommended bending moment of the HDA anchor bolt may be calculated from  $M_{rec} = M_{Rd,s} / \gamma_F = M_{Rk,s} / (\gamma_{Ms} \cdot \gamma_F) = (1,2 \cdot W_{el} \cdot f_{uk}) / (\gamma_{Ms} \cdot \gamma_F)$ , where the partial safety factor for bolts of strength 8.8 is  $\gamma_{Ms} = 1,25$ , for A4-80 equal to 1,33 and the partial safety factor for action may be taken as  $\gamma_F = 1,4$ . In case of HDA-T/TR/TF the bending capacity of the sleeve is neglected, only the capacity of the bolt is taken into account.

<http://hilti.to/traceable-fastener>
**Material quality**

Part	Material
<b>HDA-P / HDA-T</b>	
Sleeve:	Machined steel with brazed tungsten carbide tips, galvanized to min. 5 µm
Bolt M10 - M16:	Cold formed steel, strength 8.8, galvanized to min. 5 µm
Bolt M20:	Cone machined, rod strength 8.8, galvanized to min. 5 µm
Washer M10-M16:	Spring washer, galvanized or coated
Washer M20:	Washer, galvanized
Centering washer	Machined steel
<b>HDA-PR / HDA-TR</b>	
Sleeve:	Machined stainless steel with brazed tungsten carbide tips
Bolt M10 - M16:	Cone/rod: machined stainless steel
Washer	Spring washer stainless steel
Centering washer	Machined steel
<b>HDA-PF / HDA-TF</b>	
Sleeve	Machined steel with brazed tungsten carbide tips, sherardized
Bolt M10-M16:	Cold formed steel, strength 8.8, sherardized

**Anchor dimensions**

Anchor size		HDA-P / HDA-PR / HDA-T / HDA-TR / HDA-PF / HDA-TF						
		M10	M12		M16		M20	
		x100/20	x125/30	x125/50	x190/40	x190/60	x250/50	x250/100
<b>Length code letter</b>		I	L	N	R	S	V	X
Total length of bolt	$l_B$ [mm]	150	190	210	275	295	360	410
Diameter of bolt	$d_B$ [mm]	10	12		16		20	
<b>Total length of sleeve</b>								
HDA-P	$l_s$ [mm]	100	125	125	190	190	250	250
HDA-T	$l_s$ [mm]	120	155	175	230	250	300	350
Max. diameter of sleeve	$d_s$ [mm]	19	21		29		35	
Washer diameter	$d_w$ [mm]	27,5	33,5		45,5		50	
Width across flats	$S_w$ [mm]	17	19		24		30	

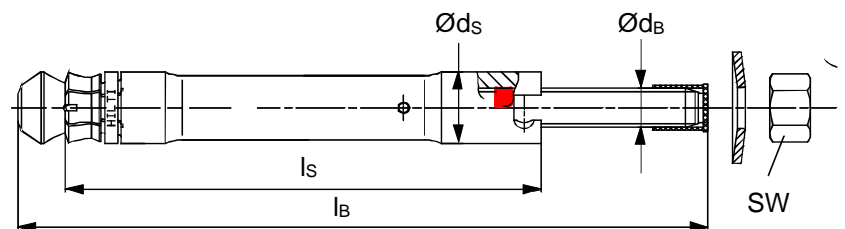
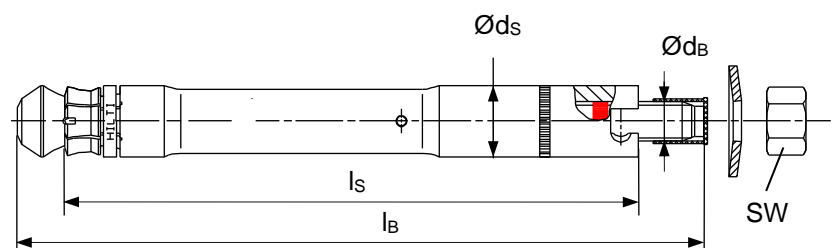
**HDA-P / HDA-PR**

**HDA-T / HDA-TR**



## Setting information

### Setting details

Anchor size		HDA-P / HDA-PR / HDA-T / HDA-TR							
		M10		M12		M16		M20	
		x100/20	x125/30	x125/50	x190/40	x190/60	x250/50	x250/100	
Length code letter		I	L	N	R	S	V	X	
Nominal drill bit diameter	$d_0$ [mm]	20	22		30		37		
Cutting diameter of drill bit	$d_{cut,min}$ [mm]	20,10	22,10		30,10		37,15		
	$d_{cut,max}$ [mm]	20,55	22,55		30,55		37,70		
Depth of drill hole	$h_1 \geq$ [mm]	107	133		203		266		
Effective anchorage depth	$h_{ef}$ [mm]	100	125		190		250		
Sleeve recess	$h_{s,min}$ [mm]	2	2		2		2		
	$h_{s,max}$ [mm]	6	7		8		8		
Torque moment	$T_{inst}$ [Nm]	50	80		120		300		
<b>For HDA-P/-PR/-PF</b>									
Clearance hole	$d_f$ [mm]	12	14		18		22		
Minimum base material thickness	$h_{min}$ [mm]	180	200		270		350		
Fixture thickness	$t_{fix,min}^*$ [mm]	0	0		0		0		
	$t_{fix,max}$ [mm]	20	30	50	40	60	50	100	
<b>For HDA-T/-TR/-TF</b>									
Clearance hole	$d_f$ [mm]	21	23		32		40		
Minimum base material thickness	$h_{min}$ [mm]	200- $t_{fix}$	230- $t_{fix}$	250- $t_{fix}$	310- $t_{fix}$	330- $t_{fix}$	400- $t_{fix}$	450- $t_{fix}$	
<b>Min. fixture thickness</b>									
Tension load only!	$t_{fix,min}$ [mm]	10	10		15		20	50	
Shear load <b>without</b> use of centering washer	$t_{fix,min}$ [mm]	15	15		20		25	50	
Shear load - <b>with</b> use of centering washer	$t_{fix,min}$ [mm]	10	10		15		20	-	
Max. fixture thickness	$t_{fix,max}$ [mm]	20	30	50	40	60	50	100	

\* Minimum fixture thickness is 10 mm under cyclic loads according to ETA-18/0974

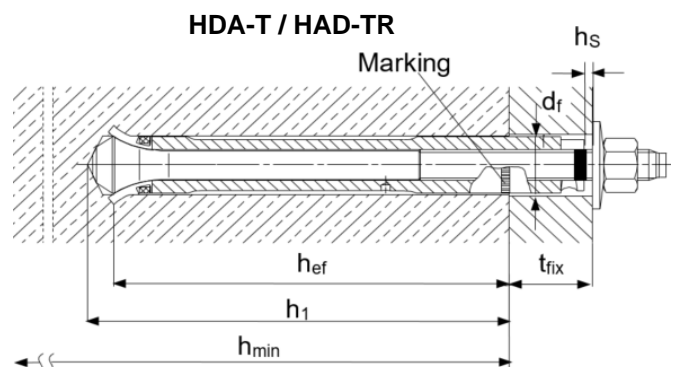
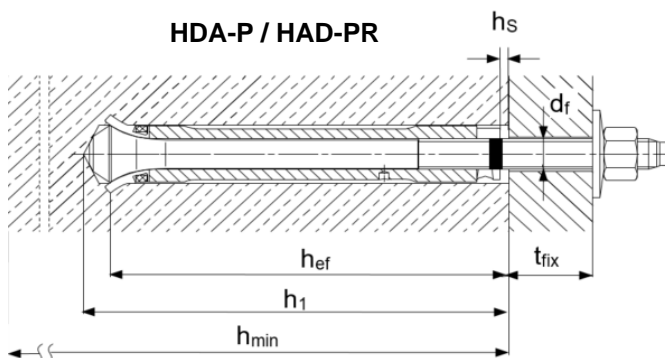



<http://hilti.to/traceable-fastener>

### Setting parameters

Anchor size	HDA-P / HDA-PR / HDA-T / HDA-TR						
	M10	M12		M16		M20	
	x100/20	x125/30	x125/50	x190/40	x190/60	x250/50	x250/100
Minimum spacing $s_{min}$ [mm]	100	125		190		250	
Minimum edge distance $c_{min}$ [mm]	80	100		150		200	
Critical spacing for splitting failure $s_{cr,sp}$ [mm]	300	375		570		750	
Critical edge distance for splitting failure $c_{cr,sp}$ [mm]	150	190		285		375	
Critical spacing for concrete cone failure $s_{cr,N}$ [mm]	300	375		570		750	
Critical edge distance for concrete cone failure $c_{cr,N}$ [mm]	150	190		285		375	

For spacing (edge distance) smaller than critical spacing (critical edge distance) the design loads have to be reduced.

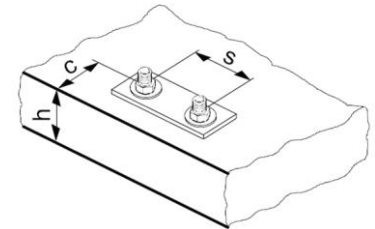
Critical spacing and critical edge distance for splitting failure apply only for non-cracked concrete. For cracked concrete only the critical spacing and critical edge distance for concrete cone failure are decisive.



### Stop drill bit HDA

The stop drill is required for drilling in order to achieve the correct hole depth.

The setting system (tool and setting tool) is required for transferring the specific energy for the undercutting process.

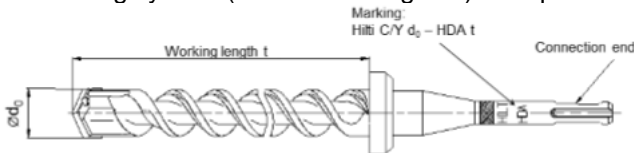



### Required stop drill bits for HDA and HDA-R

Anchor	Stop drill bit with TE-C (SDS plus) connection end	Stop drill bit with TE-Y (SDS max) connection end	Nominal working length t [mm]	Drill bit diameter $d_0$ [mm]
HDA-P/ PF/ PR M10x100/20	TE-C-HDA-B 20x100	TE-Y-HDA-B 20x100	107	20
HDA-T/ TF/ TR M10x100/20	TE-C-HDA-B 20x120	TE-Y-HDA-B 20x120	127	20
HDA-P/ PF/ PR M12x125/30 HDA-P/ PF/ PR M12x125/50	TE-C HDA-B 22x125	TE-Y HDA-B 22x125	133	22
HDA-T/ TF/ TR M12x125/30	TE-C HDA-B 22x155	TE-Y HDA-B 22x155	163	22
HDA-T/ TF/ TR M12x125/50	TE-C HDA-B 22x175	TE-Y HDA-B 22x175	183	22
HDA-P/ PF/ PR M16 x190/40 HDA-P/ PF/ PR M16 x190/60		TE-Y HDA-B 30x190	203	30
HDA-T/ TF/ TR M16x190/40		TE-Y HDA-B 30x230	243	30
HDA-T/ TF/ TR M16x190/60		TE-Y HDA-B 30x250	263	30
HDA-P M20 x250/50 HDA-P M20 x250/100		TE-Y HDA-B 37x250	266	37
HDA-T M20x250/50		TE-Y HDA-B 37x300	316	37
HDA-T M20x250/100		TE-Y HDA-B 37x350	366	37





<http://hilti.to/traceable-fastener>

Anchor 	TE 24 a) TE 25 a)		TE 30-A36	TE 35	TE 40 TE 40 AVR	TE 56 TE 56-ATC	TE 60 TE 60-ATC	TE 70 b) TE 70-ATC b)	TE 75	TE 76 TE 76-ATC	TE 80-ATC TE 80-ATC AVR	Setting tool 
	HDA-P/T M10x100/20	■	■	■		■	■	■				
HDA-P/T M12x125/30 HDA-P/T M12x125/50	■	■	■		■	■	■					TE-C-HDA-ST 22 M12 TE-Y-HDA-ST 22 M12
HDA-P/T M16x190/40 HDA-P/T M16x190/60								■	■	■	■	TE-Y-HDA-ST 30 M16
HDA-P/T M20x250/50 HDA-P/T M20x250/100								■		■	■	TE-Y-HDA-ST 37 M20



 a) 1<sup>st</sup> gear

b) With TE 70 hmin = 340 mm - tfix for tfix,max = 40 mm and hmin = 360 mm - tfix for tfix,max = 60 mm when using HDA-T(TR) M16

Anchor 	TE 24 a) TE 25 a)		TE 30-A36	TE 35	TE 40 TE 40 AVR	TE 56 TE 56-ATC	TE 60 TE 60-ATC	TE 70 b) TE 70-ATC b)	TE 75	TE 76 TE 76-ATC	TE 80-ATC TE 80-ATC AVR	Setting tool 
	HDA-PR/TR M10x100/20	■	■	■	■	■	■	■				
HDA-PR/TR M12x125/30 HDA-PR/TR M12x125/50	■	■	■	■	■	■	■					TE-C-HDA-ST 22 M12 TE-Y-HDA-ST 22 M12
HDA-PR/TR M16x190/40 HDA-PR/TR M16x190/60								■	■	■	■	TE-Y-HDA-ST 30 M16

 a) 1<sup>st</sup> gear

b) With TE 70 hmin = 340 mm - tfix for tfix,max = 40 mm and hmin = 360 mm - tfix for tfix,max = 60 mm when using HDA-T(TR) M16

Anchor 	TE 24 a) TE 25 a)		TE 30-A36	TE 35	TE 40 TE 40 AVR	TE 56 TE 56-ATC	TE 60 TE 60-ATC	TE 70 TE 70-ATC	TE 75	TE 76 TE 76-ATC	TE 80-ATC TE 80-ATC AVR	Setting tool 
	HDA-PF/TF M10x100/20			■	■	■		■				
HDA-PF/TF M12x125/30 HDA-PF/TF M12x125/50			■	■	■		■					TE-C-HDA-ST 22 M12
HDA-PF/TF M16x190/40 HDA-PF/TF M16x190/60								■	■	■	■	TE-Y-HDA-ST 30 M16

 a) 1<sup>st</sup> gear



<http://hilti.to/traceable-fastener>

## Setting instructions

\*For detailed information on installation see instruction for use given with the package of the product.

HDA-P / HDA-PR (prepositioning)	
<b>1. Drilling</b> 	<b>2. Cleaning</b> 
<b>3. Inserting the anchor by hand</b> 	<b>4. Applying hammerdrill</b> 
<b>5. Applying hammer drill</b> 	<b>6. Checking</b> 
<b>7. Attaching the fixture</b> 	<b>8. Attaching the belonging washer</b> 



<http://hilti.to/traceable-fastener>

**HDA-T / HDA-TR / HAD-TF (post-positioning)**

**1. Drilling**

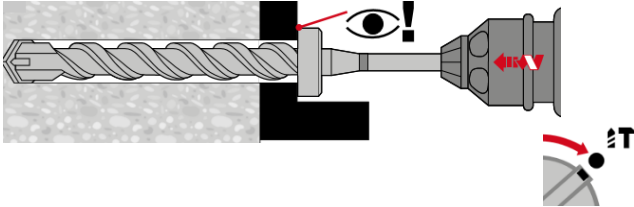

**2. Cleaning**

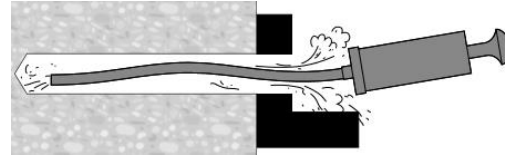

**3. Inserting the anchor by hand**

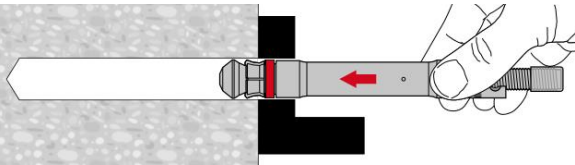

**4. Applying hammerdrill**

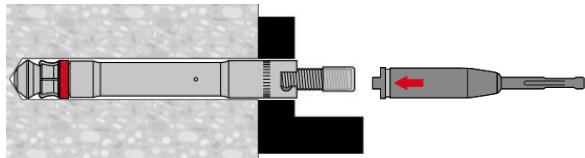

**5. Checking**

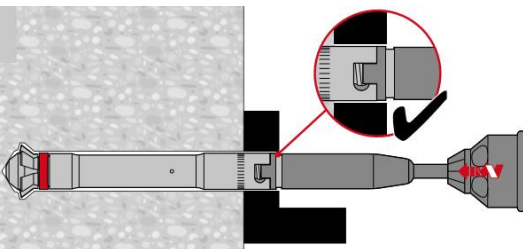

**6. Checking**

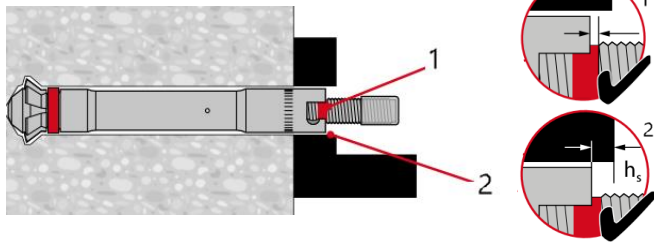

**7. Attaching the belonging washer**

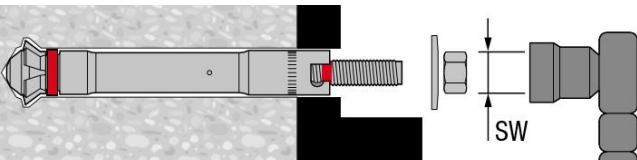



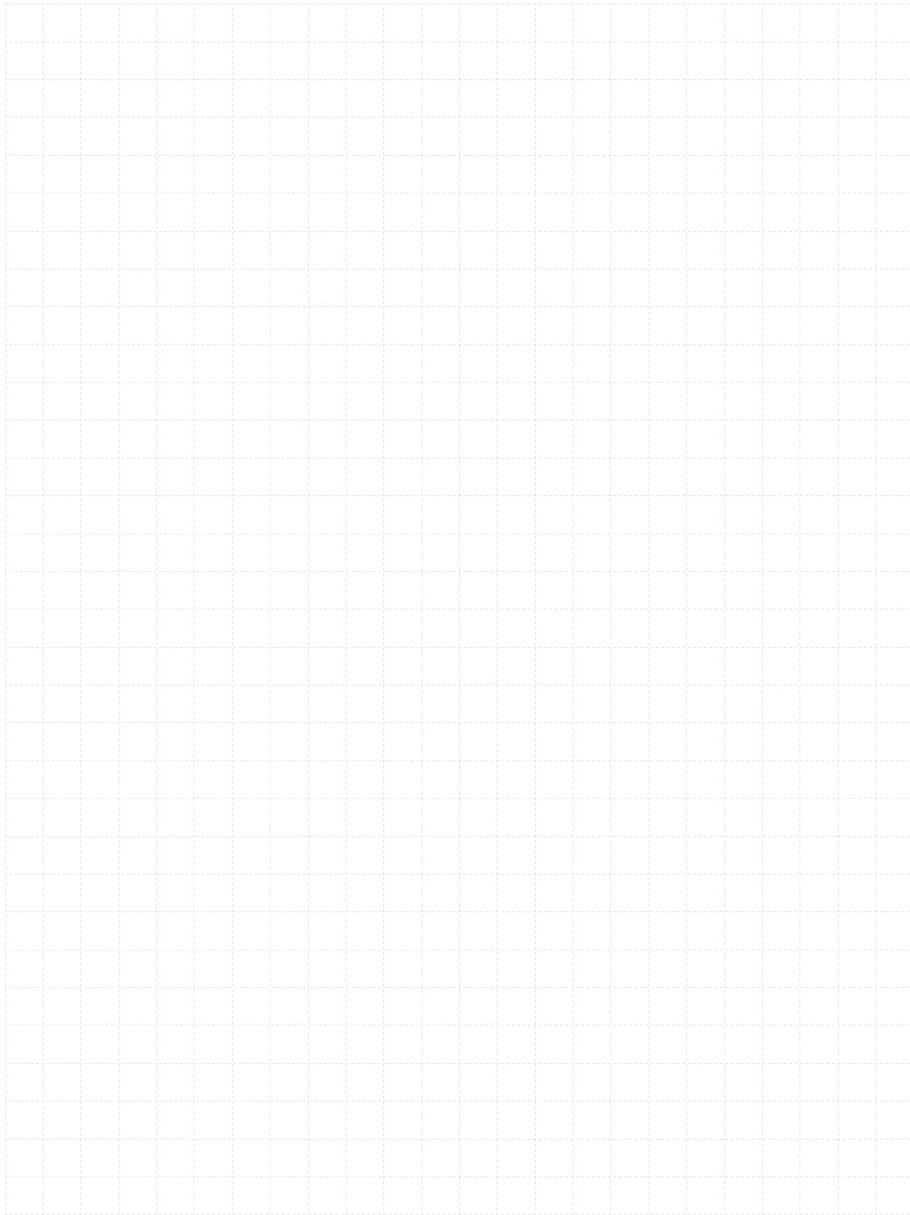







### 3.3.2 HMU-PF



# HMU-P/PF Undercut anchor

Everyday standard undercut anchor for cracked concrete

Anchor version	Benefits
 <p>HMU-P (M10-M12)</p>	<ul style="list-style-type: none"> <li>- Reliable mechanical interlock due to consistent high quality self-undercut</li> <li>- ETA approval for cracked and non-cracked concrete</li> <li>- Seismic approval ETA C1 and C2</li> <li>- Comes standard with a hot-dip galvanized protective coating against corrosion</li> </ul>
 <p>HMU-PF (M10-M16)</p>	<ul style="list-style-type: none"> <li>- Cost efficient heavy duty anchoring solution for high volume fastenings</li> <li>- Easy verification of correct setting due to red setting mark</li> <li>- Optimized and matching system components enable efficient and reliable installation</li> </ul>

Base material	Load conditions
 <p>Concrete (non-cracked)</p>  <p>Concrete (cracked)</p>	 <p>Static/ quasi-static</p>  <p>Seismic ETA-C1,C2</p>  <p>Fire resistance</p>
Installation conditions	Other information
 <p>Hammer drilled holes</p>	 <p>European Technical Assessment</p>  <p>CE conformity</p>  <p>PROFIS Engineering design Software</p>

## Approvals / certificates

Description	Authority / Laboratory	No. / date of issue
European Technical Assessment <sup>a)</sup>	CSTB, Marne-la-Vallée	ETA-14/0069 / 2020-06-05
Shockproof fastenings in civil defence installations <sup>b)</sup>	Federal Office for Civil Protection, Bern	BZS D 14-602/2014–10-31

a) All data given in this section according to ETA-14/0069, issue 2020-06-05.

b) Certificate valid only for HMU-PF M12 and HMU-PF M16.

## Static resistance

### All data in this section applies to:

- Correct setting (See setting instruction)
- No edge distance and spacing influence
- Steel failure
- Minimum base material thickness
- Concrete C 20/25,  $f_{ck,cube} = 25 \text{ N/mm}^2$

### Effective anchorage depth for static

Anchor size	M10	M12	M16	M16
Effective anchorage depth $h_{ef}$ [mm]	60	80	100	125

### Characteristic resistance

Anchor size	M10x60	M12x80	M16x100	M16x125
<b>Non-cracked concrete</b>				
Tension HMU-P/PF $N_{Rk}$ [kN]	22,9	35,2	49,2	68,8
Shear HMU-P/PF $V_{Rk}$ [kN]	23,2	33,7	62,8	62,8
<b>Cracked concrete</b>				
Tension HMU-P/PF $N_{Rk}$ [kN]	16,0	24,6	34,4	48,1
Shear HMU-P/PF $V_{Rk}$ [kN]	23,2	33,7	62,8	62,8

### Design resistance

Anchor size	M10x60	M12x80	M16x100	M16x125
<b>Non-cracked concrete</b>				
Tension HMU-P/PF $N_{Rd}$ [kN]	15,2	23,5	32,8	45,8
Shear HMU-P/PF $V_{Rd}$ [kN]	18,6	27,0	50,2	50,2
<b>Cracked concrete</b>				
Tension HMU-P/PF $N_{Rd}$ [kN]	10,7	16,4	23	32,1
Shear HMU-P/PF $V_{Rd}$ [kN]	18,6	27,0	45,9	50,2

### Recommended loads <sup>a)</sup>

Anchor size	M10x60	M12x80	M16x100	M16x125
<b>Non-cracked concrete</b>				
Tension HMU-P/PF $N_{Rec}$ [kN]	10,9	16,8	23,4	32,7
Shear HMU-P/PF $V_{Rec}$ [kN]	13,3	19,3	35,9	35,9
<b>Cracked concrete</b>				
Tension HMU-P/PF $N_{Rec}$ [kN]	7,6	11,7	16,4	22,9
Shear HMU-P/PF $V_{Rec}$ [kN]	13,3	19,3	32,8	35,9

a) With overall partial safety factor for action  $\gamma = 1,4$ . The partial safety factors for action depend on the type of loading and shall be taken from national regulations.

**Seismic resistance (for a single anchor)**
**All data in this section applies to:**

- Correct setting (See setting instruction)
- No edge distance and spacing influence
- Steel failure
- Minimum base material thickness
- Concrete C 20/25,  $f_{ck,cube} = 25 \text{ N/mm}^2$
- $\alpha_{gap} = 1,0$  (using Hilti seismic filling set)

**Effective anchorage depth for seismic C2**

Anchor size		M10	M12	M16	M16
Effective anchorage depth	$h_{ef}$ [mm]	60	80	100	125

**Characteristic resistance in case of seismic performance category C2**

Anchor size			M10x60	M12x80	M16x100	M16x125
Tension	HMU-PF	$N_{Rk,seis}$ [kN]	13,6	20,9	-	40,9
Shear	HMU-PF	$V_{Rk,seis}$	18,6	28,6	-	41,5

**Design resistance in case of seismic category C2**

Anchor size			M10x60	M12x80	M16x100	M16x125
Tension	HMU-PF	$N_{Rd,seis}$ [kN]	9,1	14,0	-	27,3
Shear	HMU-PF	$V_{Rd,seis}$	14,8	22,9	-	33,2

**Effective anchorage depth for seismic C1**

Anchor size		M10	M12	M16	M16
Effective anchorage depth range	$h_{ef}$ [mm]	60	80	100	125

**Characteristic resistance in case of seismic performance category C1**

Anchor size			M10x60	M12x80	M16x100	M16x125
Tension	HMU-P/PF	$N_{Rk,seis}$ [kN]	13,6	20,9	29,3	40,9
Shear	HMU-P/PF	$V_{Rk,seis}$	20,9	33,7	58,5	62,8

**Design resistance in case of seismic category C1**

Anchor size			M10x60	M12x80	M16x100	M16x125
Tension	HMU-P/PF	$N_{Rd,seis}$ [kN]	9,1	14,0	19,5	27,3
Shear	HMU-P/PF	$V_{Rd,seis}$	16,7	27,0	39,0	50,2

## Fire resistance

### Fire resistance data according to ETA-14/0069

#### All data in this section applies to:

- Correct setting (See setting instruction)
- No edge distance and spacing influence
- Steel failure
- Minimum base material thickness
- Concrete C 20/25,  $f_{ck,cube} = 25 \text{ N/mm}^2$

#### Effective anchorage depth

Anchor size			M10	M12	M16	M16
Effective anchorage depth	$h_{ef}$	[mm]	60	80	100	125

#### Characteristic resistance

Anchor size			M10x60	M12x80	M16x100	M16x125
<b>Fire exposure R30</b>						
Tension	HMU-P/PF	$N_{Rk,fi}$ [kN]	0,9	1,7	3,1	3,1
Shear	HMU-P/PF	$V_{Rk,fi}$ [kN]	0,9	1,7	3,1	3,1
<b>Fire exposure R120</b>						
Tension	HMU-P/PF	$N_{Rk,fi}$ [kN]	0,5	0,8	1,6	1,6
Shear	HMU-P/PF	$V_{Rk,fi}$ [kN]	0,5	0,8	1,6	1,6

#### Design resistance

Anchor size			M10x60	M12x80	M16x100	M16x125
<b>Fire exposure R30</b>						
Tension	HMU-P/PF	$N_{Rk,fi}$ [kN]	0,9	1,7	3,1	3,1
Shear	HMU-P/PF	$V_{Rk,fi}$ [kN]	0,9	1,7	3,1	3,1
<b>Fire exposure R120</b>						
Tension	HMU-P/PF	$N_{Rk,fi}$ [kN]	0,5	0,8	1,6	1,6
Shear	HMU-P/PF	$V_{Rk,fi}$ [kN]	0,5	0,8	1,6	1,6

For more information about different failure modes and fire resistance times please see the full ETA-14/0069 report.

## Materials

#### Mechanical properties

Anchor size			M10x60	M12x80	M16x100	M16x125
Nominal tensile strength	$f_{uk}$	[N/mm <sup>2</sup> ]	800	800	800	800
Yield strength	$f_{yk}$	[N/mm <sup>2</sup> ]	640	640	640	640
Stressed cross-section, thread	$A_s$	[mm <sup>2</sup> ]	58	84,3	157	157
Moment of resistance	$W$	[mm <sup>3</sup> ]	62,3	109	278	278
Char. bending resistance	$M^0_{Rk,s}$	[Nm]	59,8	105	266	266



### Material quality

	Part	Material
HMU-P (M10-M12)	Threaded bolt with cone	Carbon steel strength 8.8, galvanized to $\geq 5 \mu\text{m}$
	Sleeve	Carbon steel, galvanized to $\geq 5 \mu\text{m}$
	Hexagon nut	Steel grade 8, galvanized to $\geq 5 \mu\text{m}$
	Washer	According to DIN 125-1, 140 HV, galvanized to $\geq 5 \mu\text{m}$
HMU-PF (M10-M16)	Threaded bolt with cone	Carbon steel strength 8.8, hot dip galvanized to min. $50 \mu\text{m}$
	Sleeve	Carbon steel, hot dip galvanized min. $50 \mu\text{m}$
	Hexagon nut	Steel grade 8, hot dip galvanized min. $50 \mu\text{m}$
	Washer	According to DIN 125-1, 140 HV, hot dip galvanized min. $50 \mu\text{m}$

### Letter code for anchor length

Anchor size	HMU-P/PF M10	M10x60/20	M10x60/50	
Letter code		F	H	
Anchor size	HMU-P/PF M12	M12x80/20	M12x80/35	M12x80/65 <sup>a)</sup>
Letter code		H	I	K
Anchor size	HMU-PF M16	M16x100/30	M16x100/60	M16x125/60
Letter code		K	M	O

a) Only HMU-PF M12

### Anchor dimension

Anchor size		M10x60	M12x80	M16x100	M16x125
Total length of bolt	min	109,5	133	167	222
	max	139,5	176	197	239
Diameter of sleeve	$d_s$ [mm]	14,5	17,5	21,6	21,6
Length of sleeve	$l_s$ [mm]	61	80,6	100	125

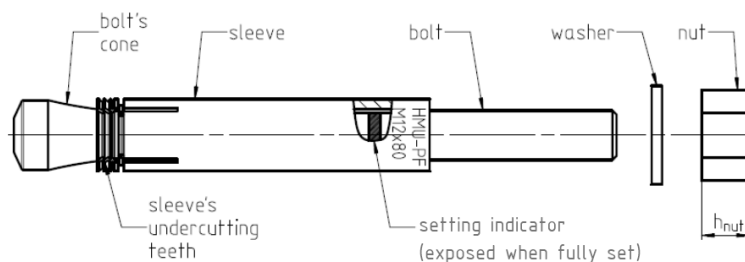
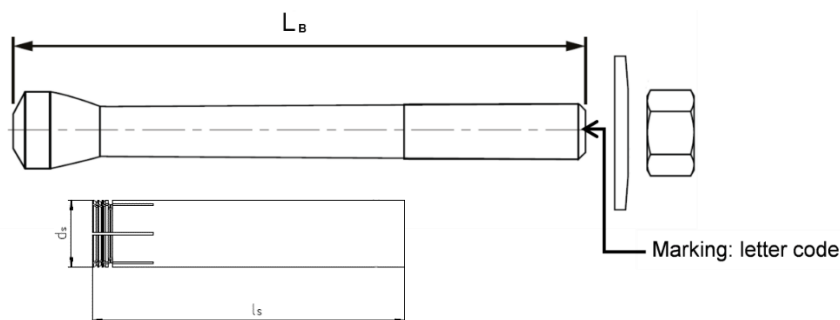

## Setting information

### Setting details of HMU-PF

Anchor size			M10x60	M12x80	M16x100	M16x125
Effective anchorage depth	$h_{ef}$	[mm]	60	80	100	125
Nominal Diameter of drill bit	$d_0$	[mm]	15	18	23	
Cutting diameter of drill bit <sup>1)</sup>	$d_{cut} \leq$	[mm]	15,5	18,5	23,0	
Depth of drill hole	$h_1 =$	[mm]	69	92	115	140
Diameter of clearance hole in the fixture	$d_f \leq$	[mm]	12	14	18	
Thickness of fixture	$t_{fix} \frac{\text{min.}}{\text{max}}$	[mm]	2	2	0 <sup>2)</sup>	0 <sup>2)</sup>
			50	65	60	75
Torque moment	$T_{inst}$	[Nm]	30	45	120	
Width across nut flats	SW	[mm]	17	19	24	

1) Use special stop drill bit TE-C-HMU-B and TE-Y-HMU-B only.

2) When thickness of attachment is less than 3mm, big washer acc. to DIN1052 standard needs to be used.

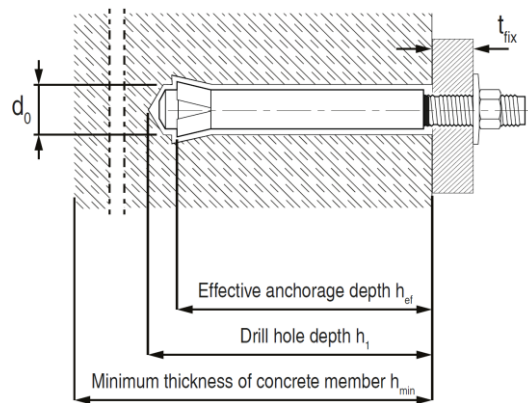

### Installation equipment

Anchor size	M10x60	M12x80	M16x100	M16x125
Rotary hammer	TE 30 / TE 30-A36	TE 40 / TE 30-A36	TE 40 / TE 50	
Stop drill bit	TE-C-HMU-B M10x60	TE-C-HMU-B M12x80	TE-C-HMU-B M16x100 TE-Y-HMU-B M16x100	TE-C-HMU-B M16x125 TE-Y-HMU-B M16x125
Setting tool	TE-C-HMU-ST-M10	TE-C-HMU-ST-M12	TE-C-HMU-ST-M16 / TE-Y-HMU-ST-M16	
Insert connections	TE-C (SDS Plus)	TE-C (SDS Plus)		TE-C (SDS Plus) TE-Y (SDS Max)
Other tools	Blow-out pump			

### Setting parameters

Anchor size		M10	M12	M16	M16
Effective anchorage depth	$h_{ef}$ [mm]	60	80	100	125
Minimum base material thickness	$h_{min} \geq$ [mm]	120	160	200	250
Minimum spacing	$s_{min} \geq$ [mm]	60	90	100	100
Minimum edge distance	$c_{min} \geq$ [mm]	55	90	100	100
Critical spacing for splitting failure	$s_{cr,sp}$ [mm]	230	300	300	375
Critical edge distance for splitting failure	$c_{cr,sp}$ [mm]	115	150	160	200
Critical spacing for concrete cone failure	$s_{cr,N}$ [mm]	180	240	300	375
Critical edge distance for concrete cone failure	$c_{cr,N}$ [mm]	90	120	150	188

In case of smaller edge distance and spacing than  $c_{cr,sp}$ ,  $s_{cr,sp}$ ,  $c_{cr,N}$  and  $s_{cr,N}$  the load values shall be reduced according to EN 1992-4.

Critical spacing and critical edge distance for splitting failure apply only for non-cracked concrete.

For cracked concrete only the critical spacing and critical edge distance for concrete cone failure are decisive.

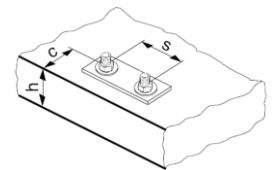

### Setting instruction

\*For detailed information on installation see instruction for use given with the package of the product.

**Setting instruction for HMU-PF**

**1. Drilling**

**2. Cleaning**

**3. Inserting the anchor by hand**

**4. Applying hammer drill**

**5. Applying hammer drill**

**6. Checking**

**7. Attaching the fixture**



**8. Attaching the belonging washer**

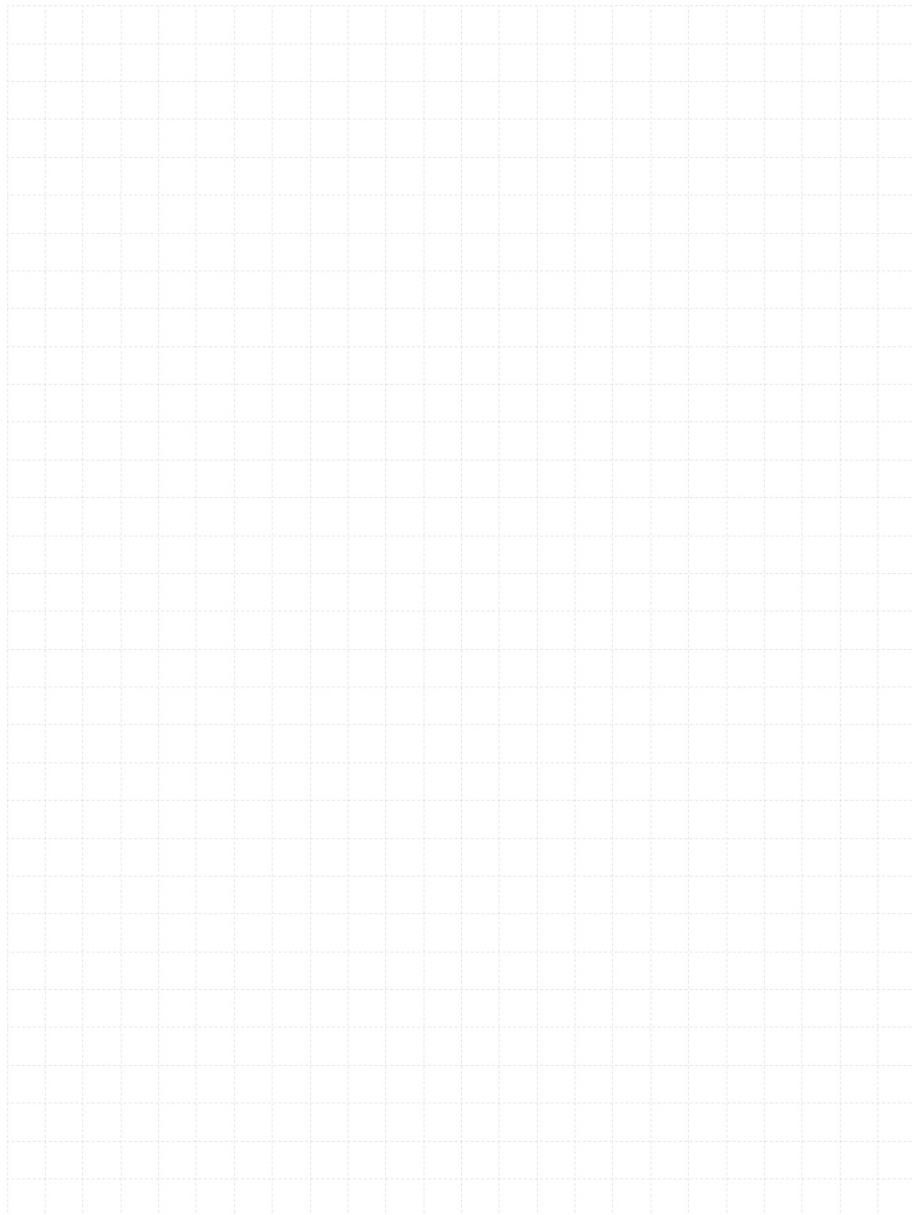



### 3.3.3 HSC-A (R)/ HSC-I (R)

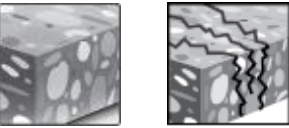

# HSC Undercut anchors

## Ultimate-performance undercut anchor for shallow embedment depth

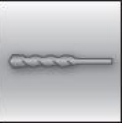
Anchor version	Benefits
 <p>HSC-A HSC-AR (M8-M12)</p>	<ul style="list-style-type: none"> <li>- The perfect solution for small edge and space distance</li> <li>- Suitable for thin concrete blocks due to low embedment depth</li> <li>- Seismic design with ETA C2 approval</li> <li>- Suitable for cracked concrete</li> <li>- Self-cutting undercut anchor</li> <li>- Available as bolt version for through applications</li> <li>- Stainless steel available for external applications</li> </ul>
 <p>HSC-I HSC-IR (M6-M12)</p>	

Base material	Load conditions
 <p>Concrete (non-cracked)    Concrete (cracked)</p>	 <p>Static/quasi-static    Shock    Fire resistance    Seismic ETA-C2</p>
Installation conditions	Other information
 <p>Hammer drilled holes</p>	 <p>European Technical Assessment    CE conformity    PROFIS Engineering design Software    Corrosion resistance A4 316</p>

### Approvals / certificates

Description	Authority / Laboratory	No. / date of issue
European Technical Assessment <sup>a)</sup>	CSTB, Marne-la-Vallée	ETA-02/0027 / 2018-07-04
Fire test report <sup>a)</sup>	CSTB, Marne-la-Vallée	ETA-02/0027 / 2018-07-04
Shockproof fastenings in civil defence installations	Federal Office for Civil Protection, Bern	BZS D 06-601 / 2006-07-10

a) All data given in this section according to ETA-02/0027 issue 2018-07-04.

## Static resistance

### All data in this section applies to:

- Correct setting (See setting instruction)
- No edge distance and spacing influence
- Steel failure
- Minimum base material thickness
- Concrete C20/25,  $f_{ck,cube} = 25 \text{ N/mm}^2$

### HSC-A (R)

#### Effective anchorage depth of HSC-A (R)

Anchor size		M8	M8	M10	M12
Effective anchorage depth	$h_{ef}$ [mm]	40	50	40	60

#### Characteristic resistance of HSC-A (R)

Anchor size		M8 x 40	M8 x 50	M10 x 40	M12 x 60	
<b>Non-cracked concrete</b>						
Tension	HSC-A, HSC-AR	$N_{Rk}$ [kN]	12,4	17,4	12,4	22,9
Shear	HSC-A	$V_{Rk}$ [kN]	14,6	14,6	23,2	33,7
	HSC-AR		12,8	12,8	20,3	29,5
<b>Cracked concrete</b>						
Tension	HSC-A, HSC-AR	$N_{Rk}$ [kN]	8,7	12,2	8,7	16,0
Shear	HSC-A	$V_{Rk}$ [kN]	14,6	14,6	17,4	32,0
	HSC-AR		12,8	12,8	17,4	29,5

#### Design resistance of HSC-A (R)

Anchor size		M8 x 40	M8 x 50	M10 x 40	M12 x 60	
<b>Non-cracked concrete</b>						
Tension	HSC-A, HSC-AR	$N_{Rd}$ [kN]	8,3	11,6	8,3	15,2
Shear	HSC-A	$V_{Rd}$ [kN]	11,7	11,7	16,6	27,0
	HSC-AR		8,2	8,2	13,0	18,9
<b>Cracked concrete</b>						
Tension	HSC-A, HSC-AR	$N_{Rd}$ [kN]	5,8	8,1	5,8	10,7
Shear	HSC-A	$V_{Rd}$ [kN]	11,7	11,7	11,6	21,3
	HSC-AR		8,2	8,2	11,6	18,9

#### Recommended loads <sup>a)</sup> of HSC-A (R)

Anchor size		M8 x 40	M8 x 50	M10 x 40	M12 x 60	
<b>Non-cracked concrete</b>						
Tension	HSC-A, HSC-AR	$N_{Rec}$ [kN]	5,9	8,3	5,9	10,9
Shear	HSC-A	$V_{Rec}$ [kN]	8,3	8,3	11,9	19,3
	HSC-AR		5,9	5,9	9,3	13,5
<b>Cracked concrete</b>						
Tension	HSC-A, HSC-AR	$N_{Rec}$ [kN]	4,1	5,8	4,1	7,6
Shear	HSC-A	$V_{Rec}$ [kN]	8,3	8,3	8,3	15,2
	HSC-AR		5,9	5,9	8,3	13,5

a) With overall partial safety factor for action  $\gamma = 1,4$ . The partial safety factors for action depend on the type of loading and shall be taken from national regulations.

**HSC-I (R)**
**Effective anchorage depth of HSC-I (R)**

Anchor size			M6	M8	M10	M10	M12
Eff. anchorage depth	$h_{ef}$	[mm]	40	40	50	60	60

**Characteristic resistance of HSC-I (R)**

Anchor size				M6 x 40	M8 x 40	M10 x 50	M10 x 60	M12 x 60
<b>Non-cracked concrete</b>								
Tension	HSC-I, HSC-IR	$N_{Rk}$	[kN]	12,4	12,4	17,4	22,9	22,9
Shear	HSC-I	$V_{Rk}$	[kN]	8,0	12,2	15,2	15,2	18,2
	HSC-IR			7,0	10,7	13,3	13,3	16,0
<b>Cracked concrete</b>								
Tension	HSC-I, HSC-IR	$N_{Rk}$	[kN]	8,7	8,7	12,2	16,0	16,0
Shear	HSC-I	$V_{Rk}$	[kN]	8,0	12,2	15,2	15,2	18,2
	HSC-IR			7,0	10,7	13,3	13,3	16,0

**Design resistance of HSC-I (R)**

Anchor size				M6 x 40	M8 x 40	M10 x 50	M10 x 60	M12 x 60
<b>Non-cracked concrete</b>								
Tension	HSC-I	$N_{Rd}$	[kN]	8,3	8,3	11,6	15,2	15,2
	HSC-IR			7,5	8,3	11,6	14,2	15,2
Shear	HSC-I	$V_{Rd}$	[kN]	6,4	9,8	12,2	12,2	14,6
	HSC-IR			4,5	6,9	8,5	8,5	10,3
<b>Cracked concrete</b>								
Tension	HSC-I, HSC-IR	$N_{Rd}$	[kN]	5,8	5,8	8,1	10,7	10,7
Shear	HSC-I	$V_{Rd}$	[kN]	6,4	9,8	12,2	12,2	14,6
	HSC-IR			4,5	6,9	8,5	8,5	10,3

**Recommended loads <sup>a)</sup> of HSC-I (R)**

Anchor size				M6 x 40	M8 x 40	M10 x 50	M10 x 60	M12 x 60
<b>Non-cracked concrete</b>								
Tension	HSC-I	$N_{Rec}$	[kN]	5,9	5,9	8,3	10,9	10,9
	HSC-IR			5,4	5,9	8,3	10,1	10,9
Shear	HSC-I	$V_{Rec}$	[kN]	4,6	7,0	8,7	8,7	10,4
	HSC-IR			3,2	4,9	6,1	6,1	7,3
<b>Cracked concrete</b>								
Tension	HSC-I, HSC-IR	$N_{Rec}$	[kN]	4,1	4,1	5,8	7,6	7,6
Shear	HSC-I	$V_{Rec}$	[kN]	4,6	7,0	8,7	8,7	10,4
	HSC-IR			3,2	4,9	6,1	6,1	7,3

a) With overall partial safety factor for action  $\gamma = 1,4$ . The partial safety factors for action depend on the type of loading and shall be taken from national regulations.

### Seismic loading (for a single anchor)

#### All data in this section applies to:

- Correct setting (See setting instruction)
- No edge distance and spacing influence
- Steel failure
- Cracked concrete
- Minimum base material thickness
- Concrete C 20/25,  $f_{ck,cube} = 25 \text{ N/mm}^2$
- $\alpha_{gap} = 1,0$  (using Hilti seismic filling set)

#### Effective anchorage depth of HSC-A

Anchor size		M8	M8	M10	M12
Effective anchorage depth range	$h_{ef}$ [mm]	40	50	40	60

#### Characteristic resistance for HSC-A in case of seismic performance C2

Anchor size				M8 x 40	M8 x 50	M10 x 40	M12 x 60
Tension	HSC-A	$N_{Rk, se}$	[kN]	2,4	2,4	4,5	-
Shear	HSC-A	$V_{Rk, se}$	[kN]	12,4	12,4	17,4	-

#### Design resistance for HSC-A in case of seismic performance C2

Anchor size				M8 x 40	M8 x 50	M10 x 40	M12 x 60
Tension	HSC-A	$N_{Rd, se}$	[kN]	1,6	1,6	3,0	-
Shear	HSC-A	$V_{Rd, se}$	[kN]	9,9	9,9	11,6	-



**Fire resistance**
**All data in this section applies to:**

- Correct setting (See setting instruction)
- No edge distance and spacing influence
- Steel failure
- Minimum base material thickness
- Concrete C 20/25,  $f_{ck,cube} = 25 \text{ N/mm}^2$

**HSC-A (R)**
**Effective anchorage depth of HSC-A (R)**

Anchor size			M8	M8	M10	M12
Effective anchorage depth	$h_{ef}$	[mm]	40	50	40	60

**Characteristic/design<sup>1</sup> resistance**

Anchor size				M8 x 40	M8 x 50	M10 x 40	M12 x 60
<b>Fire Exposure R30</b>							
Tension	HSC-A	$N_{Rk,fi}$	[kN]	0,4	0,4	0,9	1,7
	HSC-AR			0,7	0,7	1,5	2,5
Shear	HSC-A	$V_{Rk,fi}$	[kN]	0,4	0,4	0,9	1,7
	HSC-AR			0,7	0,7	1,5	2,5
<b>Fire Exposure R120</b>							
Tension	HSC-A	$N_{Rk,fi}$	[kN]	0,2	0,2	0,5	0,8
	HSC-AR			0,4	0,4	0,8	1,3
Shear	HSC-A	$V_{Rk,fi}$	[kN]	0,2	0,2	0,5	0,8
	HSC-AR			0,4	0,4	0,8	1,3

 1) The safety factor is  $\gamma=1.0$  for all load cases

**HSC-I (R)**
**Effective anchorage depth of HSC-I (R)**

Anchor size			M6	M8	M10	M10	M12
Effective anchorage depth	$h_{ef}$	[mm]	40	40	50	60	60

**Characteristic/design<sup>1</sup> resistance**

Anchor size				M6 x 40	M8 x 40	M10 x 50	M10 x 60	M12 x 60
<b>Fire Exposure R30</b>								
Tension	HSC-I	$N_{Rk,fi}$	[kN]	0,2	0,4	0,9	0,4	1,7
	HSC-IR			0,2	0,7	1,5	0,7	2,5
Shear	HSC-I	$V_{Rk,fi}$	[kN]	0,2	0,4	0,9	0,4	1,7
	HSC-IR			0,2	0,7	1,5	0,7	2,5
<b>Fire Exposure R120</b>								
Tension	HSC-I	$N_{Rk,fi}$	[kN]	0,1	0,2	0,5	0,2	0,8
	HSC-IR			0,1	0,4	0,8	0,4	1,3
Shear	HSC-I	$V_{Rk,fi}$	[kN]	0,1	0,2	0,5	0,2	0,8
	HSC-IR			0,1	0,4	0,8	0,4	1,3

 1) The safety factor is  $\gamma=1.0$  for all load cases

**Materials**
**Mechanical properties for HSC-A (R)**

Anchor size				M8 x 40	M8 x 50	M10 x 40	M12 x 60
Nominal tensile strength	HSC-A	$f_{uk}$	[N/mm <sup>2</sup> ]	800	800	800	800
	HSC-AR			700	700	700	700
Yield strength	HSC-A	$f_{yk}$	[N/mm <sup>2</sup> ]	640	640	640	640
	HSC-AR			450	450	450	450
Stressed cross-section for bolt version	HSC-A HSC-AR	$A_{s,A}$	[mm <sup>2</sup> ]	36,6	36,6	58,0	84,3
Moment of resistance	HSC-A HSC-AR	W	[mm <sup>3</sup> ]	31,2	31,2	62,3	109,2
Characteristic bending resistance	HSC-A	$M^0_{Rk,s}$	[Nm]	30	30	60	105
	HSC-AR			26	26	52	92

**Mechanical properties for HSC-I (R)**

Anchor size				M6 x 40	M8 x 40	M10 x 50	M10 x 60	M12 x 60
Nominal tensile strength	HSC-I	$f_{uk}$	[N/mm <sup>2</sup> ]	800	800	800	800	800
	HSC-IR			700	700	700	700	700
Yield strength	HSC-I	$f_{yk}$	[N/mm <sup>2</sup> ]	640	640	640	640	640
	HSC-IR			355	355	350	350	340
Stressed cross-section for internal thread version	HSC-I HSC-IR	$A_{s,I}$	[mm <sup>2</sup> ]	22,0	28,3	34,6	34,6	40,8
Moment of resistance	HSC-I HSC-IR	W	[mm <sup>3</sup> ]	12,7	31,2	62,3	62,3	109,2
Characteristic bending resistance	HSC-I	$M^0_{Rk,s}$	[Nm]	12	30	60	60	105
	HSC-IR			11	26	52	52	92

**Material quality**

Part	Material	
<b>Metal parts made of zinc coated steel</b>		
HSC-A HSC-I	Cone bolt with external thread (-A)	Carbon steel strength 8.8, galvanized to min. 5 µm
	Cone bolt with internal thread (-I)	
	Expansion sleeve	Galvanized to min. 5 µm
	Washer	
	Hexagon nut	
<b>HSC-AR / HSC-IR Stainless steel</b>		
HSC-AR HSC-IR	Cone bolt with external thread (-AR)	A4-70, Stainless steel 1.4401, 1.4571 EN 10088-1:2014
	Cone bolt with internal thread (-IR)	
	Expansion sleeve	Stainless steel 1.4401, 1.4571 EN 10088-1:2014
	Washer	
	Hexagon nut	

**Anchor dimension of HSC-A (R)**

Anchor size		M8 x 40	M8 x 50	M10 x 40	M12 x 60
Diameter of cone bolt	b [mm]	13,5	13,5	15,5	17,5
Length of expansion sleeve	$l_s$ [mm]	40,8	50,8	40,8	60,8
Diameter of expansion sleeve	d [mm]	13,5	13,5	15,5	17,5
Diameter of washer	e [mm]	16	16	20	24

marking HILTI 8.8 (or A4)

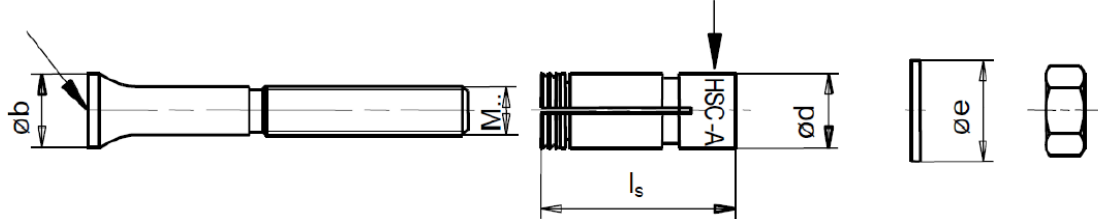
 marking e.g. HSC-A M8 x 40 / $t_{fix}$  (or HSC-AR M8 x 40 / $t_{fix}$ A4)

**Anchor dimension of HSC-I (R)**

Anchor size		M6 x 40	M8 x 40	M10 x 50	M10 x 60	M12 x 60
Length of cone bolt	$l_b$ [mm]	43,3	43,3	54,8	64,8	64,8
Diameter of cone bolt	b [mm]	13,5	15,5	17,5	17,5	19,5
Length of expansion sleeve	$l_s$ [mm]	40,8	40,8	50,8	60,8	60,8
Diameter of expansion sleeve	d [mm]	13,5	15,5	17,5	17,5	19,5

marking HILTI 8.8 (or A4)

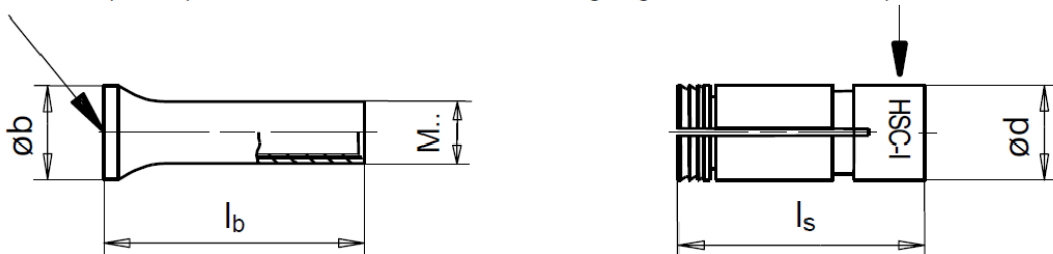
marking e.g. HSC-I M6 x 40 (or HSC-IR M6 x 40 A4)



**Setting information**
**Setting details of HSC-A (R)**

Anchor size		M8 x 40	M8 x 50	M10 x 40	M12 x 60
Effective anchorage depth	$h_{ef}$ [mm]	40	50	40	60
Nominal Diameter of drill bit	$d_0$ [mm]	14	14	16	18
Cutting diameter of drill bit <sup>1)</sup>	$d_{cut}$ [mm]	14,5	14,5	16,5	18,5
Maximum fastening thickness	$t_{fix}$ [mm]	15	15	20	20
Depth of drill hole	$h_1$ [mm]	46	56	46,5	68
Diameter of clearance hole in the fixture	$d_f \leq$ [mm]	9	9	12	14
Torque moment	$T_{inst}$ [Nm]	10	10	20	30
Width across nut flats	SW [mm]	13	13	17	19

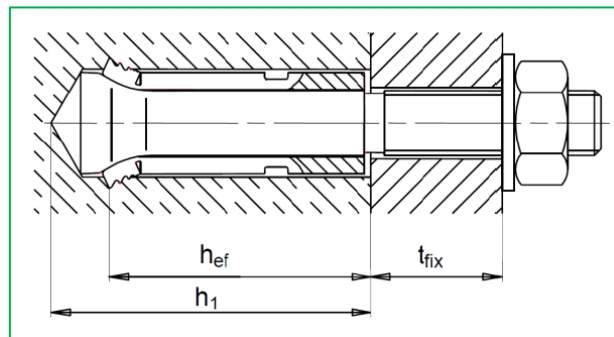
**Setting details of HSC-I (R)**

Anchor size		M6 x 40	M8 x 40	M10 x 50	M10 x 60	M12 x 60
Effective anchorage depth	$h_{ef}$ [mm]	40	40	50	60	60
Nominal Diameter of drill bit	$d_0$ [mm]	14	16	18	18	20
Cutting diameter of drill bit <sup>1)</sup>	$d_{cut} \leq$ [mm]	14,5	16,5	18,5	18,5	20,5
Depth of drill hole	$h_1 =$ [mm]	46	46,5	56	68	68,5
Diameter of clearance hole in the fixture	$d_f \leq$ [mm]	7	9	12	12	14
Torque moment	$T_{inst}$ [Nm]	10	10	20	30	30
Width across nut flats	SW [mm]	10	13	17	17	19
Screwing depth	min s [mm]	6	8	10	10	12
	max s [mm]	16	22	28	28	30

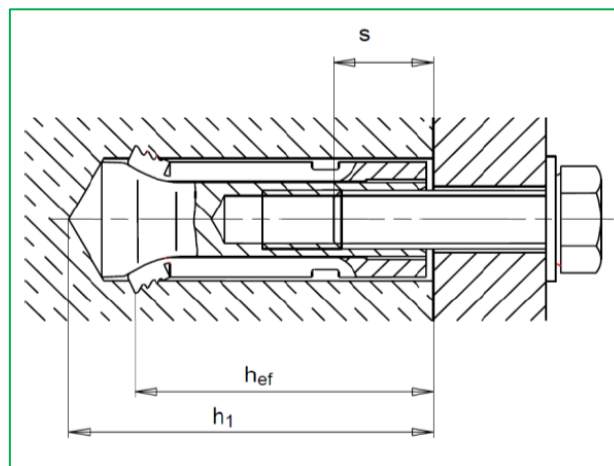

**Installation equipment for HSC-A (R)**

Anchor size		M8 x 40	M8 x 50	M10 x 40	M12 x 60
Rotary hammer for setting		TE 7-C; TE 7-A; TE 16; TE 16-C; TE 16-M; TE 25; TE 30; TE 35		TE 7-C; TE 7-A; TE 25; TE 35	TE 16; TE 16-C; TE 16-M; TE 25; TE 30; TE 35; TE 40; TE 40-AVR
Stepped drill bit	TE-C-HSC-B	14x40	14x50	16x40	18x60
Setting tool	TE-C-HSC-MW	14	14	16	18

**Installation equipment for HSC-I (R)**

Anchor size		M6 x 40	M8 x 40	M10 x 50	M10 x 60	M12 x 60
Rotary hammer for setting		TE 7-C; TE 7-A; TE 16; TE 16-C; TE 16-M; TE 25; TE 30; TE 35				TE 16; TE 16-C; TE 16-M; TE 25; TE 30; TE 35; TE 40; TE 40-AVR
Stepped drill bit	TE-C-HSC-B	14x40	16x40	18x50	18x60	20x60
Setting tool	TE-C-HSC-MW	14	16	18	18	20
Insert tool	TE-C-HSC-EW	14	16	18	18	20

**Setting parameters for HSC-A (R)**

Anchor size		M8 x 40	M8 x 50	M10 x 40	M12 x 60
Effective anchorage depth	$h_{ef}$ [mm]	40	50	40	60
Minimum base material thickness	$h_{min} \geq$ [mm]	100	100	100	130
Minimum spacing	$s_{min} \geq$ [mm]	40	50	40	60
Minimum edge distance	$c_{min} \geq$ [mm]	40	50	40	60
Critical spacing for splitting failure	$s_{cr,sp}$ [mm]	130	170	120	180
Critical edge distance for splitting failure	$c_{cr,sp}$ [mm]	65	85	60	90
Critical spacing for concrete cone failure	$s_{cr,N}$ [mm]	120	150	120	180
Critical edge distance for concrete cone failure	$c_{cr,N}$ [mm]	60	75	60	90

**Setting parameters for HSC-I (R)**

Anchor size		M6 x 40	M8 x 40	M10 x 50	M10 x 60	M12 x 60
Effective anchorage depth	$h_{ef}$ [mm]	40	40	50	60	60
Minimum base material thickness	$h_{min} \geq$ [mm]	100	100	100	100	130
Minimum spacing	$s_{min} \geq$ [mm]	40	40	50	60	60
Minimum edge distance	$c_{min} \geq$ [mm]	40	40	50	60	60
Critical spacing for splitting failure	$s_{cr,sp}$ [mm]	130	120	170	180	180
Critical edge distance for splitting failure	$c_{cr,sp}$ [mm]	65	60	85	90	90
Critical spacing for concrete cone failure	$s_{cr,N}$ [mm]	120	120	150	180	180
Critical edge distance for concrete cone failure	$c_{cr,N}$ [mm]	60	60	75	90	90

In case of smaller edge distance and spacing than  $c_{cr,sp}$ ,  $s_{cr,sp}$ ,  $c_{cr,N}$  and  $s_{cr,N}$  the load values shall be reduced according EN 1992-4.

Critical spacing and critical edge distance for splitting failure apply only for non-cracked concrete.

For cracked concrete only the critical spacing and critical edge distance for concrete cone failure are decisive.

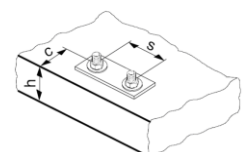

**Setting instruction**

\*For detailed information on installation see instruction for use given with the package of the product.

Setting instruction for HSC-A (R)	
<b>1. Drilling</b> 	<b>2. Cleaning</b> 
<b>3. Inserting the anchor by hand</b> 	<b>4. Applying hammer drill</b> 
<b>5. Applying hammer drill</b> 	<b>6. Checking</b> 
<b>7. Attaching the fixture</b> 	<b>8. Attaching the belonging washer</b> 

**Setting instruction for HSC-I (R)**

**1. Drilling**

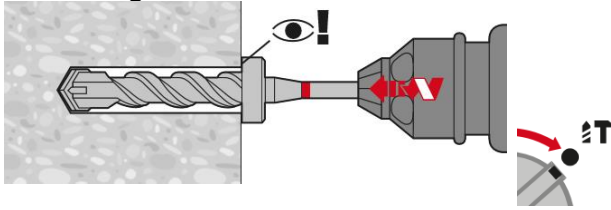

**2. Cleaning**

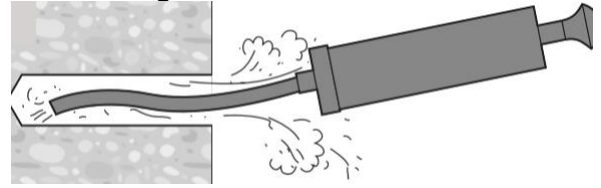

**3. Inserting the anchor by hand**

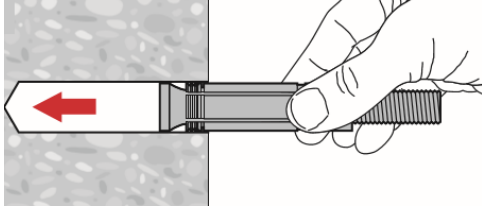

**4. Inserting the tool HSC-EW14**

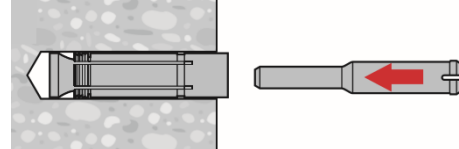

**5. Applying hammer drill**

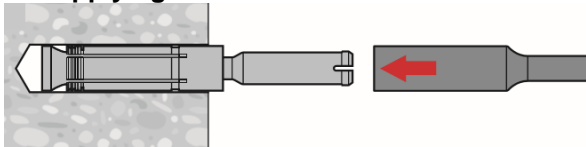

**6. Applying hammer drill**



**7. Applying hammer drill**

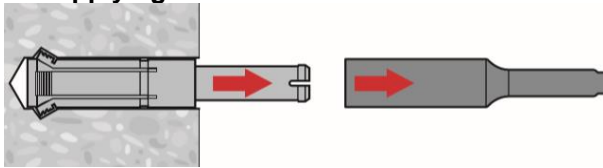

**8. Checking**

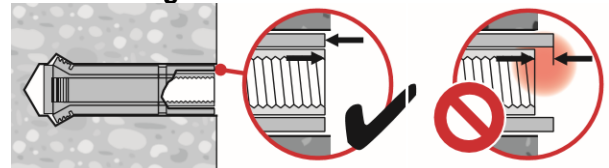

**9. Attaching the fixture**



**10. Attaching the belonging washer**

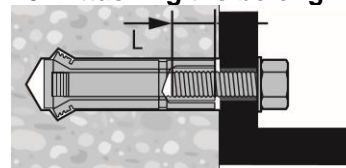

**11.**

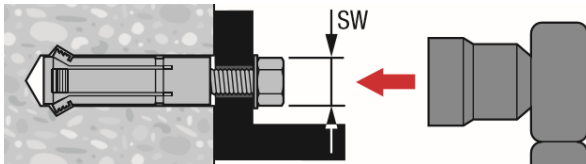

## 3.4 Flush anchors

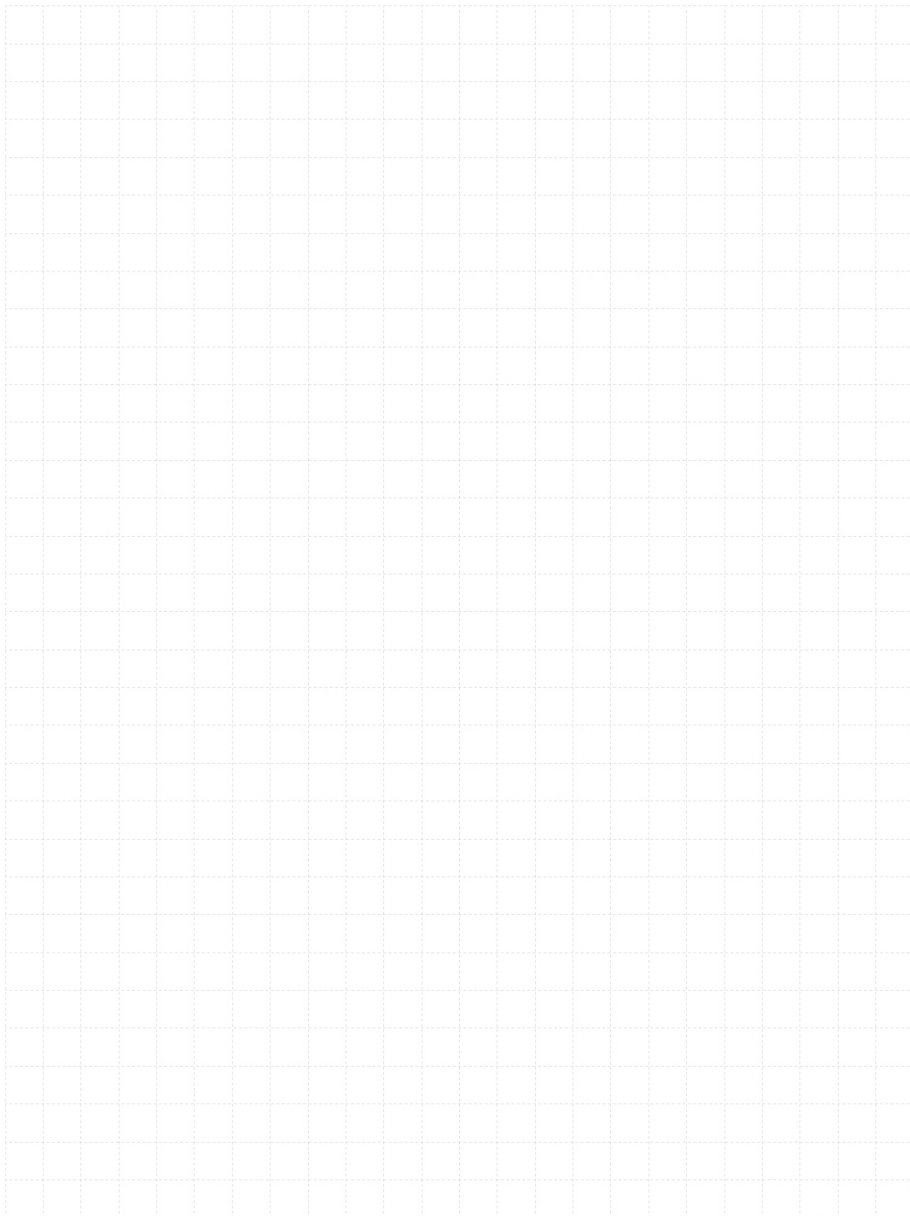
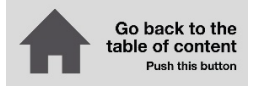

### 3.4.1 HKD









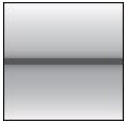

# HKD Flush anchor

## Everyday standard manual set flush anchor for single anchor applications

Anchor version	Benefits
 <p>HKD (M8-M20)</p>	<ul style="list-style-type: none"> <li>- Simple and well proven</li> <li>- Approved, tested and confirmed by everyday jobsite experience</li> <li>- Reliable setting thanks to simple visual check</li> <li>- Versatile</li> <li>- For medium-duty fastening with bolts or threaded rods</li> <li>- Available in various materials and sizes for maximized coverage of possible applications</li> </ul>
 <p>HKD-S(R) (M6-M20)</p>	
 <p>HKD-E(R) (M6-M20)</p>	

Base material	Load conditions
 <p>Concrete (non-cracked)</p>	 <p>Static/ quasi-static</p>
Installation conditions	Other information
 <p>Hammer drilled holes</p>	 <p>European Technical Assessment</p>  <p>CE conformity</p>  <p>PROFIS Engineering design software</p>  <p>A4 316 Corrosion resistance</p>

### Approvals / certificates

Description	Authority / Laboratory	No. / date of issue
European Technical Assessment <sup>a)</sup>	CSTB, Marne-la-Vallée	ETA-02/0032 / 2020-11-04
Hilti technical data	Hilti	

a) All data given in this section according to ETA-02/0032, issue 2015-01-07.

## Static resistance

### All data in this section applies to:

- Correct setting (See setting instruction)
- No edge distance and spacing influence
- Concrete as specified in the table
- Steel failure
- Minimum base material thickness
- Concrete C 20/25,  $f_{ck,cube} = 25 \text{ N/mm}^2$
- Screw or rod with steel grade 5.8 (carbon steel) and / or A4-70 (stainless steel)

### Effective anchorage depth for static

Anchor size	M6	M8	M10	M12	M16	M8	M8	M10	M10	M12	M16	M20
Effective anchorage depth $h_{ef}$ [mm]	25	25	25	25	30	30	40	30	40	50	65	80

### Characteristic resistance

Anchor size		Hilti technical data				ETA-02/0032, issued 2020-11-04							
		M6x25	M8x25	M10x25	M12x25	M6x30	M8x30	M8x40	M10x30	M10x40	M12x50	M16x65	M20x80
Tension	HKD	6,1	6,1	6,1	6,1	-	8,1	9,0	8,1	12,4	17,4	25,8	35,2
	HKD-S, HKD-E	6,1	-	-	-	8,1	8,1	9,0	8,1	12,4	17,4	25,8	35,2
	HKD-SR, HKD-ER	6,1	-	-	-	8,1	8,1	-	-	12,4	17,4	25,8	35,2
Shear	HKD	5,0	6,1	6,1	6,1	-	8,6	9,2	10,0	11,0	18,3	33,8	49,5
	HKD-S, HKD-E	5,0	-	-	-	5,0	7,0	7,0	7,4	8,0	14,1	21,9	34,7
	HKD-SR, HKD-ER	6,2	-	-	-	6,4	8,4	-	-	10,5	18,7	32,1	51,0

### Design resistance

Anchor size		Hilti technical data				ETA-02/0032, issued 2020-11-04							
		M6x25	M8x25	M10x25	M12x25	M6x30	M8x30	M8x40	M10x30	M10x40	M12x50	M16x65	M20x80
Tension	HKD	4,1	4,1	4,1	4,1	-	5,4	6,0	5,4	8,3	11,6	17,2	23,5
	HKD-S, HKD-E	4,1	-	-	-	5,4	5,4	5,0	5,4	8,3	11,6	17,2	23,5
	HKD-SR, HKD-ER	4,1	-	-	-	5,4	5,4	-	-	8,3	11,6	17,2	23,5
Shear	HKD	4,0	4,1	4,1	4,1	-	6,9	7,3	8,0	8,8	14,6	27,0	39,6
	HKD-S, HKD-E	3,9	-	-	-	3,9	5,5	5,5	5,9	6,4	11,3	17,5	27,8
	HKD-SR, HKD-ER	4,1	-	-	-	4,2	5,5	-	-	6,9	12,3	21,1	33,6

**Recommended loads <sup>a)</sup>**

Anchor size		Hilti technical data				ETA-02/0032, issued 2020-11-04								
		M6x25	M8x25	M10x25	M12x25	M6x30	M8x30	M8x40	M10x30	M10x40	M12x50	M16x65	M20x80	
Tension	HKD	2,9	2,9	2,9	2,9	-	3,8	3,6	3,8	5,9	8,3	12,3	16,8	
	HKD-S, HKD-E	$N_{Rec}$ [kN]	2,9	-	-	-	3,8	3,8	3,6	3,8	5,9	8,3	12,3	16,8
	HKD-SR, HKD-ER		2,9	-	-	-	3,8	3,8	-	-	5,9	8,3	12,3	16,8
Shear	HKD	$V_{Rec}$ [kN]	2,9	2,9	2,9	2,9	-	4,9	5,2	5,7	6,3	10,5	19,3	28,3
	HKD-S, HKD-E		2,8	-	-	-	2,8	3,9	4,2	3,9	4,6	8,1	12,5	19,8
	HKD-SR, HKD-ER		2,9	-	-	-	3,0	3,9	-	-	4,9	8,8	15,1	24,0

a) With overall partial safety factor for action  $\gamma = 1,4$ . The partial safety factors for action depend on the type of loading and shall be taken from national regulations.

**Materials**
**Mechanical properties**

Anchor size		M6	M8	M10	M12	M16	M20	
Nominal tensile strength	HKD	$f_{uk}$ [N/mm <sup>2</sup> ]	570	570	570	570	640	590
	HKD-S, HKD-E		560	560	510	510	-	460
	HKD-SR, HKD-ER		540	540	540	540	-	540
Yield strength	HKD	$f_{yk}$ [N/mm <sup>2</sup> ]	460	460	460	480	510	470
	HKD-S, HKD-E		440	440	410	410	-	375
	HKD-SR, HKD-ER		355	355	355	355	-	355
Stressed cross-section	HKD	$A_s$ [mm <sup>2</sup> ]	20,7	26,7	32,7	60,1	105	167
	HKD-S, HKD-E		20,9	26,1	28,8	58,7	-	163
	HKD-SR, HKD-ER							
Moment of resistance	HKD	$W$ [mm <sup>3</sup> ]	32,3	54,6	82,9	184	431	850
	HKD-S, HKD-E		50	79	110	264	602	1191
	HKD-SR, HKD-ER							
Char. bending resistance for rod or bolt	With 5.8 Gr. Steel	$M^{0}_{Rk,s}$ [Nm]	7,6	18,7	37,4	65,5	167	325
	HKD-SR		11	26	52	92	187	454
	HKD-ER with A4-70							

**Material quality**

Part	Material	
Anchor body	HKD	Cold formed steel / galvanised to min. 5 $\mu$ m
	HKD-S, HKD-E	Steel Fe/Zn5 galvanised to min. 5 $\mu$ m
	HKD-SR, HKD-ER	Stainless steel, 1.4401, 1.4404, 1.4571
Expansion plug	HKD	Cold formed steel
	HKD-S, HKD-E	Cold formed steel
	HKD-SR, HKD-ER	Stainless steel, 1.4401, 1.4404, 1.4571

**Anchor dimensions of HKD, HKD-S, HKD-E, HKD-SR, HKD-ER**

Anchor size			Hilti technical data				ETA-02/0032, issued 2015-01-07							
			M6x25	M8x25	M10x25	M12x25	M6x30	M8x30	M8x40	M10x30	M10x40	M12x50	M16x65	M20x80
Eff. anchorage depth	$h_{ef}$	[mm]	25	25	25	25	30	30	40	30	40	50	65	80
Anchor diameter	$d_1$	[mm]	7,9	9,95	11,9	14,9	8	9,95	9,95	11,8	11,95	14,9	19,75	24,75
Plug diameter	$d_2$	[mm]	5,1	6,35	8,1	9,7	5	6,5	6,35	8,2	8,2	10,3	13,8	16,4
Plug length	$l_1$	[mm]	10	7	7	7,2	15	12	16	12	16	20	29	30

**Anchor body**

HKD

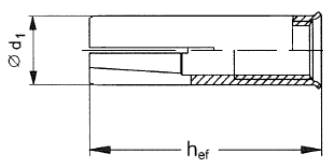

HKD-S and HKD-SR

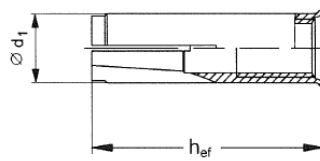
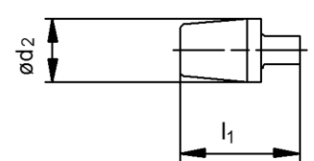
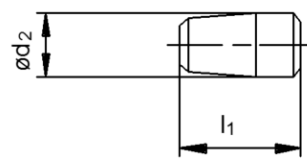

**Expansion plugs**

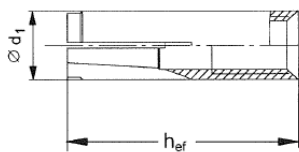
HKD-E and HKD ER

**Setting information**
**Setting details**

Anchor size			Hilti technical data				ETA-02/0032, issued 2015-01-07							
			M6x25	M8x25	M10x25	M12x25	M6x30	M8x30	M8x40	M10x30 <sup>a)</sup>	M10x40	M12x50	M16x65	M20x80
Effective embedment depth	$h_{ef}$	[mm]	25	25	25	25	30	30	40	30	40	50	65	80
Nominal diameter of drill bit	$d_o$	[mm]	8	10	12	15	8	10	10	12	12	15	20	25
Cutting diameter of drill bit	$d_{cut} \leq$	[mm]	8,45	10,5	12,5	15,5	8,45	10,5	10,5	12,5	12,5	15,5	20,5	25,5
Depth of drill hole	$h_1 \geq$	[mm]	27	27	27	27	32	33	43	33	43	54	70	85
Screwing depth	$l_{s,min}$	[mm]	6	8	10	12	6	8	8	10	10	12	16	20
Thread engagement depth	$l_{s,max}$	[mm]	12	11,5	12	12	12,5	14,5	17,5	12,7	18	23,5	30,5	42
Diameter of clearance hole in the fixture	$d_f \leq$	[mm]	7	9	12	14	7	9	9	12	12	14	18	22
Max. torque moment	$T_{inst}$	[Nm]	4	8	15	35	4	8	8	15	15	35	60	100

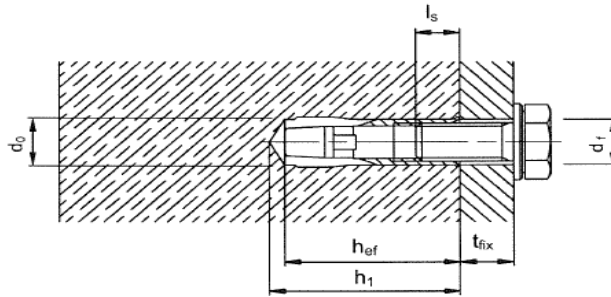
a) With anchor size M10x30 only threaded rod is to be used.



### Installation equipment

Anchor size		M6	M8	M10	M10	M12	M16
Rotary hammer for setting		TE 1 – TE 3				TE 16 – TE 50	
Machine setting tool	HSD-M	6x25/30	8x25/30	10x25/30	10x40	12x50	16x65
Hand setting tool	HSD-G HSD-M	6x25/30	8x25/30	10x25/30	10x40	12x50	16x65
Other tools		hammer, torque wrench, blow out pump					

### Setting parameters

Anchor size		Hilti technical data				ETA-02/0032, issued 2015-01-07							
		M6x25	M8x25	M10x25	M12x25	M6x30	M8x30	M8x40	M10x30	M10x40	M12x50	M16x65	M20x80
Minimum base material thickness	$h_{min}$ [mm]	100	100	100	100	100	100	100	100	100	100	130	160
Minimum spacing and minimum edge distance HKD-S (R) / HKD-E (R)	$s_{min}$ [mm]	60	60	60	60	60	60	80	60	80	125	130	160
	$c_{min}$ [mm]	88	88	88	88	105	105	140	105	140	175	230	280
Minimum spacing HKD	$s_{min}$ [mm]	80	80	80	80	60	60	80	60	80	125	130	160
	$c \geq$ [mm]	140	140	140	140	105	105	140	105	140	175	230	280
Minimum edge distance HKD	$c_{min}$ [mm]	100	100	100	100	80	80	140	80	140	175	230	280
	$s \geq$ [mm]	150	150	150	150	120	120	80	120	80	125	130	160
Critical spacing and edge distance for splitting failure HKD	$s_{cr,sp}$ [mm]	200	200	200	200	210	210	280	210	280	350	455	560
	$c_{cr,N}$ [mm]	100	100	100	100	105	105	140	105	140	175	227	280
Critical spacing and edge distance for concrete cone failure HKD / HKDS-(R) / HKD-E(R)	$s_{cr,N}$ [mm]	80	80	80	80	90	90	120	90	120	150	195	240
	$c_{cr,N}$ [mm]	40	40	40	40	45	45	60	45	60	75	97	120
Critical spacing and edge distance for splitting failure HKD-S(R) / HKD-E(R)	$s_{cr,sp}$ [mm]	176	176	176	176	210	210	280	210	280	350	455	560
	$c_{cr,N}$ [mm]	88	88	88	88	105	105	140	105	140	175	227	280

For spacing (edge distance) smaller than critical spacing (critical edge distance) the design loads have to be reduced.

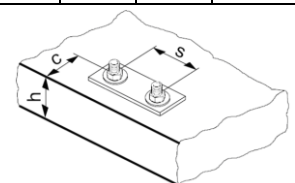

## Setting instruction

\*For detailed information on installation see instruction for use given with the package of the product.

Setting instruction	
<p><b>1. Drilling</b></p>	<p><b>2. Cleaning</b></p>
<p><b>3. Inserting the anchor</b></p>	<p><b>4. Setting tools</b></p>
<p><b>5. Inserting the tools</b></p>	<p><b>6. Inserting the tools</b></p>
<p><b>7. Attaching the belonging washer</b></p>	



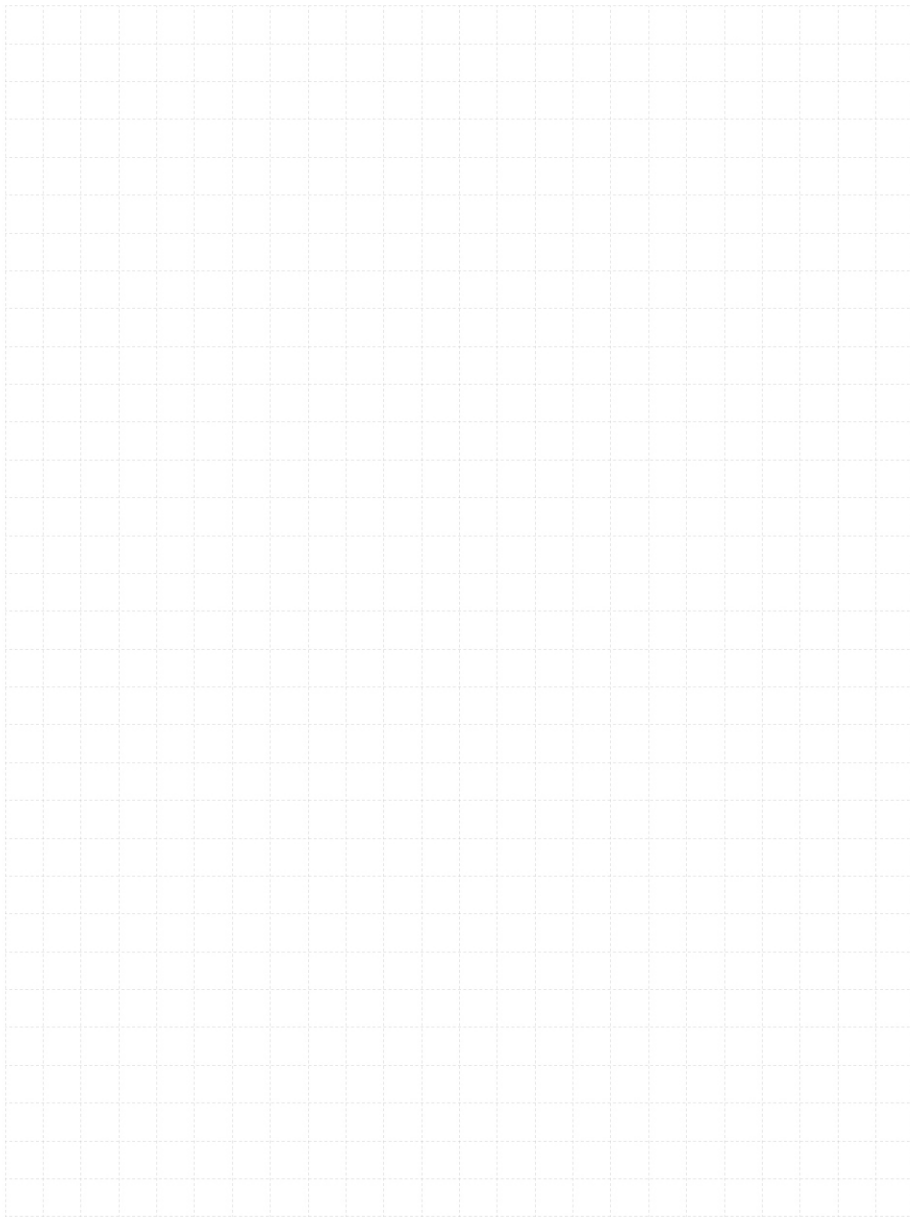

### 3.4.2 HKD redundant













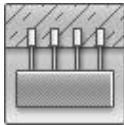

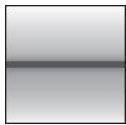

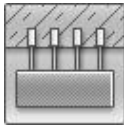

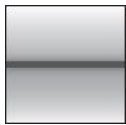
# HKD Flush anchor

Everyday standard manual set flush anchor for redundant fastening applications

Anchor version	Benefits
 <p>HKD (M6-M16)</p>	<ul style="list-style-type: none"> <li>- Simple and well proven</li> <li>- Approved, tested and confirmed by everyday jobsite experience</li> <li>- Reliable setting thanks to simple visual check</li> <li>- Versatile</li> <li>- For medium-duty fastening with bolts or threaded rods</li> <li>- Available in various materials and sizes for maximized coverage of possible applications</li> </ul>
 <p>HKD-woL (M6-M16)</p>	
 <p>HKD-S(R) (M6-M12)</p>	
 <p>HKD-E(R) (M6-M12)</p>	

Base material	Load conditions
 <p>Concrete (non-cracked)</p>	 <p>Concrete (cracked)</p>  <p>Redundant fastening</p>  <p>Pre-stressed hollow core slabs</p>  <p>Static/quasi-static</p>  <p>Fire resistance</p>
 <p>Concrete (cracked)</p>	
 <p>Redundant fastening</p>	
 <p>Pre-stressed hollow core slabs</p>	
 <p>Static/quasi-static</p>	
 <p>Fire resistance</p>	

Other information			
 <p>European Technical Assessment</p>	 <p>CE conformity</p>	 <p>Sprinkler approved</p>	 <p>Corrosion resistance</p>

## Approvals / certificates

Description	Authority / Laboratory	No. / date of issue
European Technical Assessment <sup>a)</sup>	DIBt, Berlin	ETA-06/0047 / 2016-02-08
Fire test report	DIBt, Berlin	ETA-06/0047 / 2016-02-08
Assessment report fire	Warringtonfire	WF 327804/A / 2013-07-10

a) All data given in this section according to ETA-06/0047, issue 2016-02-08.



## Static and quasi-static resistance

### All data in this section applies to:

- Correct setting (See setting instruction)
- No edge distance and spacing influence
- Minimum base material thickness
- Concrete C20/25,  $f_{ck,cube} = 25 \text{ N/mm}^2$
- Anchors in redundant fastening

### Effective anchorage depth for static

Anchor size	M6	M6	M8	M8	M8	M10	M10	M10	M12	M12	M16
Effective anchorage depth $h_{ef}$ [mm]	25	30	25	30	40	25	30	40	25	50	65

### Characteristic resistance

Anchor size	M6x25	M6x30	M8x25	M8x30	M8x40	M10x25	M10x30	M10x40	M12x25	M12x50	M16x65
Resistance, all load directions											
HKD / HKD-woL	2,0	-	3,0	5,0	5,0	4,0	5,0	7,5	4,0	9,0	16,0
HKD-S/ HKD-E	-	3,0	-	3,0	5,0	-	4,0	6,0	-	6,0	-
HKD-SR/ HKD-ER	-	3,0	-	3,0	-	-	-	6,0	-	6,0	-

### Design resistance

Anchor size	M6x25	M6x30	M8x25	M8x30	M8x40	M10x25	M10x30	M10x40	M12x25	M12x50	M16x65
Resistance, all load directions											
HKD / HKD-woL	1,3	-	2,0	2,8	3,3	2,2	3,3	5,0	2,7	6,0	10,7
HKD-S/ HKD-E	-	2,0	-	2,0	3,3	-	2,7	4,0	-	4,0	-
HKD-SR/ HKD-ER	-	2,0	-	2,0	-	-	-	4,0	-	4,0	-

### Recommended loads <sup>a)</sup>

Anchor size	M6x25	M6x30	M8x25	M8x30	M8x40	M10x25	M10x30	M10x40	M12x25	M12x50	M16x65
Resistance, all load directions											
HKD / HKD-woL	1,0	-	1,4	2,0	2,4	1,6	2,4	3,6	1,9	4,3	7,6
HKD-S/ HKD-E	-	1,4	-	1,4	2,4	-	1,9	2,9	-	2,9	-
HKD-SR/ HKD-ER	-	1,4	-	1,4	-	-	-	2,9	-	2,9	-

a) With overall partial safety factor for action  $\gamma = 1,4$ . The partial safety factors for action depend on the type of loading and shall be taken from national regulations.

## Fire resistance

### All data in this section applies to:

- Correct setting (See setting instruction)
- No edge distance and spacing influence
- Steel failure
- Minimum base material thickness
- Concrete C 20/25 to C50/60
- Partial safety factor for resistance under fire exposure  $\gamma_{M,fi} = 1,0$  (in absence of other national regulations)

### Effective anchorage depth for fire

Anchor size	M6	M6	M8	M8	M8	M10	M10	M10	M12	M12	M16
Effective anchorage depth $h_{ef}$ [mm]	25	30	25	30	40	25	30	40	25	50	65

### Characteristic resistance

Anchor size		M6x25	M6x30	M8x25	M8x30	M8x40	M10x25	M10x30	M10x40	M12x25	M12x50	M16x65
<b>Fire exposure R30</b>												
Resistance, all load directions	HKD / HKD-woL	0,5	-	0,6	0,9	1,3	0,6	0,9	1,8	0,6	2,3	4,0
	HKD-SR/ HKD-ER	-	0,5	-	0,9	-	-	-	1,8	-	2,3	-
<b>Fire exposure R120</b>												
Resistance, all load directions	HKD / HKD-woL	0,2	-	0,5	0,7	0,7	0,5	0,7	1,5	0,5	1,8	3,2
	HKD-SR/ HKD-ER	-	0,3	-	0,7	-	-	-	1,5	-	1,8	-

### Design resistance

Anchor size		M6x25	M6x30	M8x25	M8x30	M8x40	M10x25	M10x30	M10x40	M12x25	M12x50	M16x65
<b>Fire exposure R30</b>												
Resistance, all load directions	HKD / HKD-woL	0,5	-	0,6	0,9	1,3	0,6	0,9	1,8	0,6	2,3	4,0
	HKD-SR/ HKD-ER	-	0,5	-	0,9	-	-	-	1,8	-	2,3	-
<b>Fire exposure R120</b>												
Resistance, all load directions	HKD / HKD-woL	0,2	-	0,5	0,7	0,7	0,5	0,7	1,5	0,5	1,8	3,2
	HKD-SR/ HKD-ER	-	0,3	-	0,7	-	-	-	1,5	-	1,8	-

For more information about different failure modes and fire resistance times please see the full ETA-06/0047 report.

### Requirements for redundant fastening

The definition of redundant fastening according to Member States is given in EN 1992-4 and CEN/TR 17079. In absence of a definition by a Member State the following default values may be taken.

Minimum number of fixing points	Minimum number of anchors per fixing point	Maximum design load of action $N_{Sd}$ per fixing point <sup>a)</sup>
3	1	2 kN
4	1	3kN

- a) The value for maximum design load of actions per fastening point  $N_{Sd}$  is valid in general that means all fastening points are considered in the design of the redundant structural system. The value  $N_{Sd}$  may be increased if the failure of one (=most unfavorable) fixing point is taken into account in the design (serviceability and ultimate limit state) of the structural system e.g. suspended ceiling.

**Materials**
**Mechanical properties**

Anchor size		M6	M8	M10	M10	M12
Nominal tensile strength	HKD / HKD-woL	570	570	570	570	640
	HKD-S, HKD-E	560	560	510	510	-
	HKD-SR, HKD-ER	540	540	540	540	-
Yield strength	HKD / HKD-woL	460	460	460	480	510
	HKD-S, HKD-E	440	440	410	410	-
	HKD-SR, HKD-ER	355	355	355	355	-
Stressed cross-section	HKD / HKD-woL	20,7	26,7	32,7	60,1	105
	HKD-S, HKD-E	20,9	26,1	28,8	58,7	-
	HKD-SR, HKD-ER					
Moment of resistance	HKD / HKD-woL	32,3	54,6	82,9	184	431
	HKD-S, HKD-E	50	79	110	264	-
	HKD-SR, HKD-ER					
Characteristic bending resistance for rod or bolt	With 5.8 Gr. Steel	7,6	18,7	37,4	65,5	167
	HKD-SR HKD-ER with A4-70	11	26	52	92	-

**Material quality**

Part	Material	
Anchor body	HKD / HKD-woL	Cold formed steel-galvanized to $\geq 5 \mu\text{m}$
	HKD-S, HKD-E	Steel Fe/Zn5, galvanized to $\geq 5 \mu\text{m}$
	HKD-SR, HKD-ER	Stainless steel, 1.4401, 1.4404, 1.4571 EN 10088-3:2014
Expansion plug	HKD / HKD-woL	Cold formed steel
	HKD-S, HKD-E	Cold formed steel
	HKD-SR, HKD-ER	Stainless steel, 1.4401, 1.4404, 1.4571 EN 10088-3:2014

**Anchor dimensions of HKD, HKD-S, HKD-E, HKD-SR, HKD-ER**

Anchor size		M6x25	M8x25	M10x25	M12x25	M6x30	M8x30	M8x40	M10x30	M10x40	M12x50	M16x65
		Anchor length	$l_G$ [mm]	25	30	25	30	40	25	30	40	25
Anchor diameter	$\varnothing_{d1}$ [mm]	7,9	8	9,95	9,95	9,95	11,9	11,8	11,95	14,9	14,9	19,75
Plug diameter	$\varnothing_{d2}$ [mm]	5,1	5	6,35	6,5	6,35	8,1	8,2	8,2	9,7	10,3	13,8
Plug length	$l_1$ [mm]	10	15	7	12	16	7	12	16	7,2	20	29

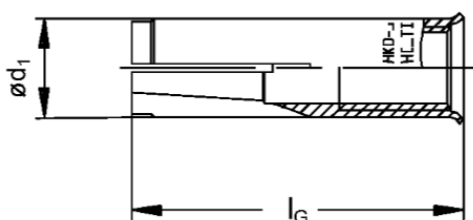
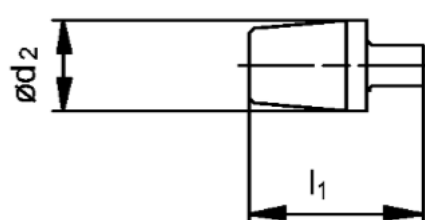
**Anchor body**

**Expansions plugs**

## Setting information

### Setting details

Anchor size		M6x25	M6x30	M8x25 <sup>a)</sup>	M8x30	M8x40	M10x25 <sup>a)</sup>	M10x30 <sup>a)</sup>	M10x40	M12x25 <sup>a)</sup>	M12x50	M16x65
Effective anchorage depth	$h_{ef}$ [mm]	25	30	25	30	40	25	30	40	25	50	65
Nominal diameter of drill bit	$d_0$ [mm]	8	8	10	10	10	12	12	12	15	15	20
Thread diameter	$d$ [mm]	6	6	8	8	8	10	10	10	12	12	16
Depth of drill hole	$h_1$ [mm]	27	32	27	33	43	27	33	43	27	54	70
Diameter of clearance hole in the fixture	$d_f$ [mm]	7	7	9	9	9	12	12	12	14	14	18
Torque moment	$T_{inst}$ [mm]	4	4	8	8	8	15	15	15	35	35	60
Screwing depth	$l_{s,min}$ [mm]	6	6	8	8	8	10	10	10	12	12	16
	$l_{s,max}$ [mm]	12	12,5	11,5	14,5	17,5	12	12,7	18	12	23,5	30,5

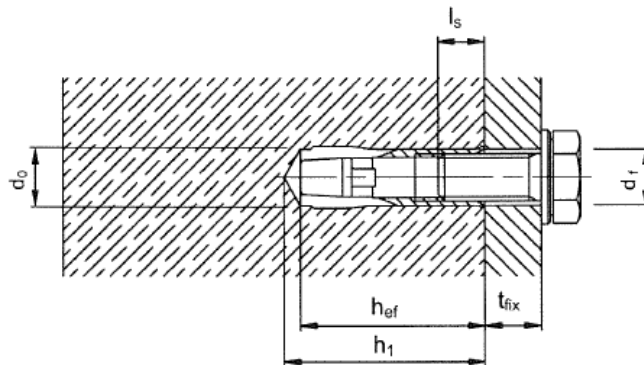
a) With anchor size M8x25, M10x25, M10x30 and M12x25 only threaded rod are to be used.



### Installation equipment

Anchor size		M6x25	M8x25	M10x25	M12x25	M6x30	M8x30	M8x40	M10x30	M10x40	M12x50	M16x65
Rotary hammer for setting		TE 2 – TE 16									TE16–TE50	
Machine setting tool	HSD-M	6x25/30	8x25/30	8x40	10x25/30	10x40	12x25	12x50	16x65			
Hand setting tool	HSD-G											
Other tools		Hammer, torque wrench, blow out pump										

**Setting parameters**

Anchor size		M6x25	M6x30	M8x25 <sup>a)</sup>	M8x30	M8x40	M10x25 <sup>a)</sup>	M10x30 <sup>a)</sup>	M10x40	M12x25 <sup>a)</sup>	M12x50	M16x65
<b>Minimum spacing and minimum edge distance for HKD / HKD-woL</b>												
Minimum thickness of concrete member	$h_{min}$ [mm]	100	-	100	100	100	100	100	100	100	100	120
Minimum spacing	$s_{min}$ [mm]	80	-	80	60	80	80	60	80	80	125	130
	$c \geq$ [mm]	140	-	140	105	140	140	105	140	140	175	230
Minimum edge distance	$c_{min}$ [mm]	100	-	100	80	140	100	80	140	100	175	230
	$s \geq$ [mm]	150	-	150	120	80	150	120	80	150	125	130
<b>Minimum thickness of concrete member for HKD / HKD-woL</b>												
Minimum thickness of concrete member	$h_{min}$ [mm]	80	-	80	80	80	80	80	80	80	-	-
Minimum spacing	$s_{min}$ [mm]	200	-	200	200	200	200	200	200	200	-	-
Minimum edge distance	$c_{min}$ [mm]	150	-	150	150	150	150	150	150	150	-	-
<b>Minimum spacing and minimum edge distance for HKD-S(R) / HKD-S(R)</b>												
Minimum thickness of concrete member	$h_{min}$ [mm]	-	100	-	100	100	-	100	100	-	100	-
Minimum spacing	$s_{min}$ [mm]	-	60	-	60	80	-	60	80	-	125	-
Minimum edge distance	$c_{min}$ [mm]	-	105	-	105	140	-	105	140	-	175	-
<b>Minimum thickness of concrete member for HKD-S(R) / HKD-S(R)</b>												
Minimum thickness of concrete member	$h_{min}$ [mm]	-	80	-	80	80	-	80	80	-	-	-
Diameter of clearance hole in the fixture	$s_{min}$ [mm]	-	200	-	200	200	-	200	200	-	-	-
Torque moment	$c_{min}$ [mm]	-	150	-	150	150	-	150	150	-	-	-

For spacing (edge distance) smaller than critical spacing (critical edge distance) the design loads have to be reduced.

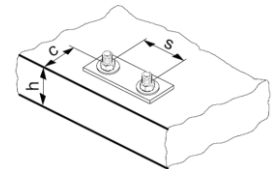

## Setting instruction

\*For detailed information on installation see instruction for use given with the package of the product.

Setting instruction	
<b>1. Drilling</b> 	<b>2. Cleaning</b> 
<b>3. Inserting the anchor</b> 	<b>4. Setting tools</b> <p>HSD-G M8x30</p> <p>HSD-M M8x30</p>
<b>5. Inserting the tools</b> 	<b>6. Inserting the tools</b> 
<b>7. Attaching the belonging washer</b> <p><math>T_{inst}</math></p>	<b>8.</b> <p><math>L_s</math></p> <p><math>d_s</math></p>

## Basic loading data for redundant fastening in prestressed hollow core slabs

### All data in this section applies to:

- Correct anchor setting (See setting instruction)
- No edge distance and spacing influence
- Ratio core width/web thickness  $w/e \leq 4,2$
- Concrete C 30/37 to C50/56
- Data is according to ETA-06/0047

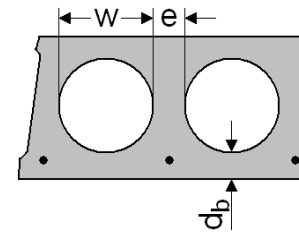

### Characteristic resistance

Anchor size			M6x25	M8x25	M10x25
Bottom flange thickness	$d_b$ [mm]		$\geq 35$ (30 <sup>a</sup> )	$\geq 35$	$\geq 40$
Resistance, all load directions	HKD / HKD-wol	$F_{Rk}$ [kN]	2	3	4

- a) The anchor may be used in a flange thickness of 30 mm with the same resistance but the drill hole is not allowed to cut cavity

### Design resistance

Anchor size			M6x25	M8x25	M10x25
Bottom flange thickness	$d_b$ [mm]		$\geq 35$ (30 <sup>a</sup> )	$\geq 35$	$\geq 40$
Resistance, all load directions	HKD / HKD-wol	$F_{Rd}$ [kN]	1,3	2,0	2,2

- a) The anchor may be used in a flange thickness of 30 mm with the same resistance but the drill hole is not allowed to cut cavity

### Recommended loads <sup>b)</sup>

Anchor size			M6x25	M8x25	M10x25
Bottom flange thickness	$d_b$ [mm]		$\geq 35$ (30 <sup>a</sup> )	$\geq 35$	$\geq 40$
Resistance, all load directions	HKD / HKD-wol	$F_{Rec}$ [kN]	1,0	1,4	1,6

- a) The anchor may be used in a flange thickness of 30 mm with the same resistance but the drill hole is not allowed to cut cavity

- b) With overall partial safety factor for action  $\gamma = 1,4$ . The partial safety factors for action depend on the type of loading and shall be taken from national regulations.

### Requirements for redundant fastening

The definition of redundant fastening according to Member States is given in EN 1992-4 and CEN/TR 17079. In absence of a definition by a Member State the following default values may be taken.

Minimum number of fixing points	Minimum number of anchors per fixing point	Maximum design load of action $N_{Sd}$ per fixing point <sup>a)</sup>
3	1	2 kN
4	1	3kN

- a) The value for maximum design load of actions per fastening point  $N_{Sd}$  is valid in general that means all fastening points are considered in the design of the redundant structural system. The value  $N_{Sd}$  may be increased if the failure of one (=most unfavorable) fixing point is taken into account in the design (serviceability and ultimate limit state) of the structural system e.g. suspended ceiling.

**Admissible anchor positions in precast pre-stressed hollow core slabs**

Type		HKD / HKD-wol
Core distance	$l_c \geq$ [mm]	100
Pre-stressing steel distance	$l_p \geq$ [mm]	100
Distance between anchor position and pre-stressed steel	$a_p \geq$ [mm]	50

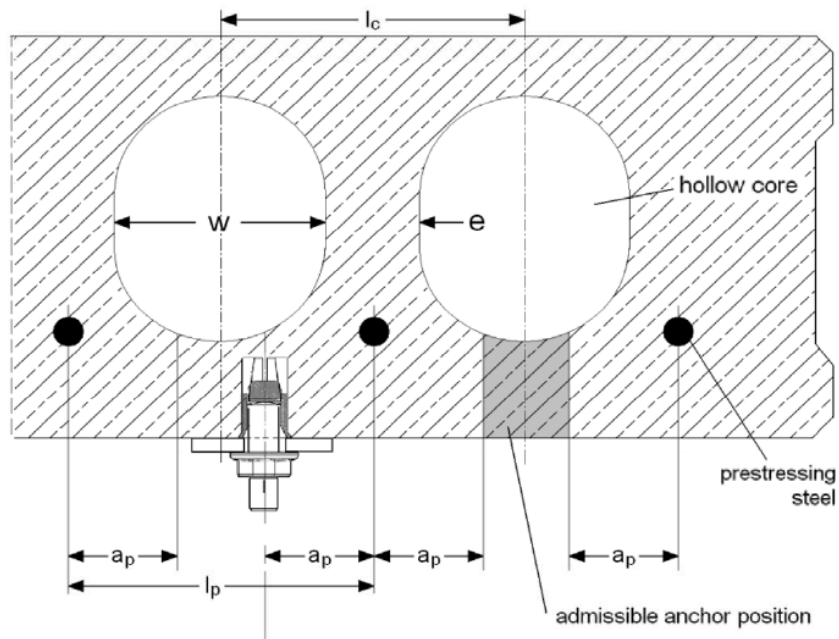
**Anchor spacing and edge distance**

Type		HKD / HKD-wol
Minimum edge distance	$c_{min} \geq$ [mm]	200
Minimum anchor spacing	$s_{min} \geq$ [mm]	400
Minimum distance between anchor groups	$a_{min} \geq$ [mm]	400

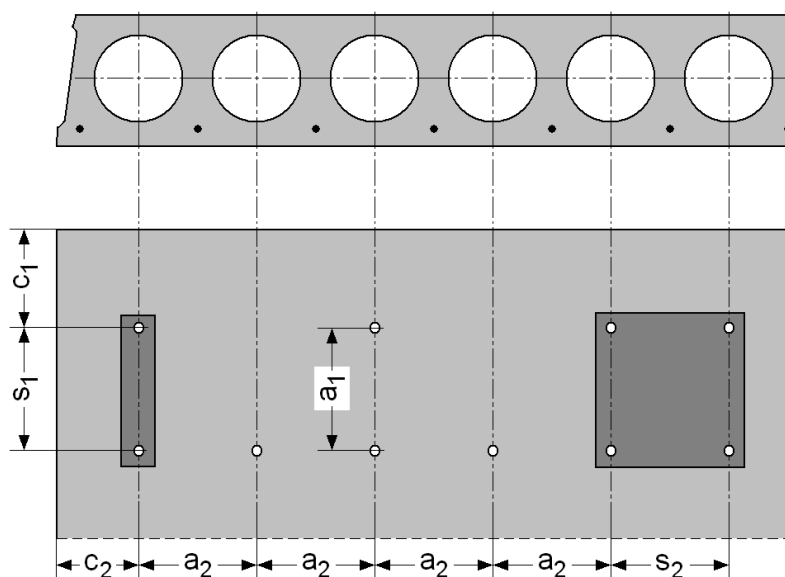

$c_1, c_2$  edge distance  
 $s_1, s_2$  anchor spacing  
 $a_1, a_2$  distances between anchor groups



**Setting instruction with the stop drill bit TE-CX-HKD only**

**1. Positioning pre-stressed steel**



**2. Marking pre-stressed steel position**

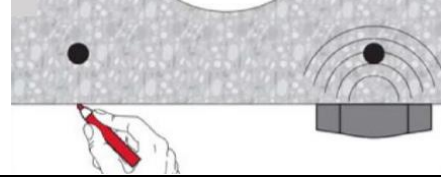

**3. Marking pre-stressed steel position**



**4. Drilling**

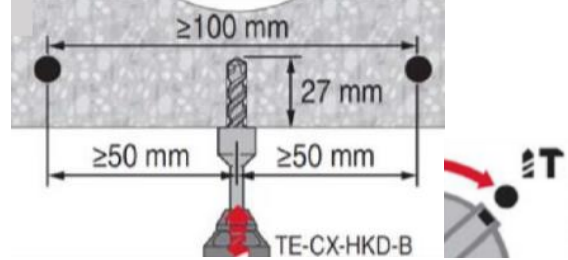

**5. Cleaning**

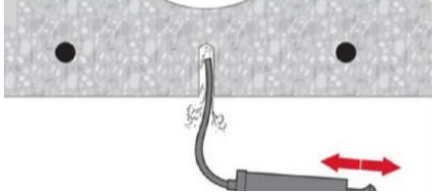

**6. Inserting the anchor**

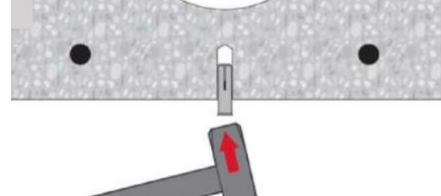

**7. Setting tools**

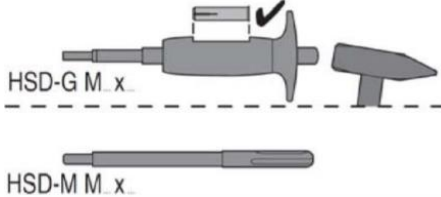

**8. Inserting the tools**

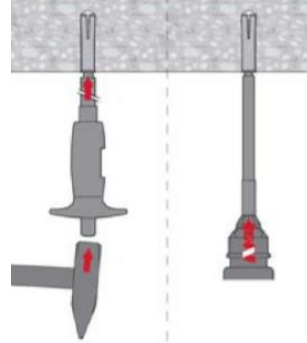

**9. Inserting the tools**

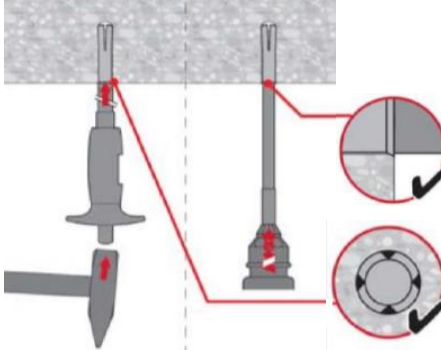

**10. Attaching the belonging washer**

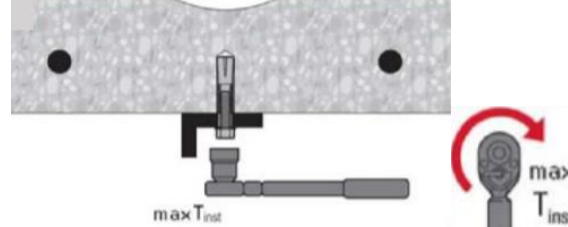

**11.**

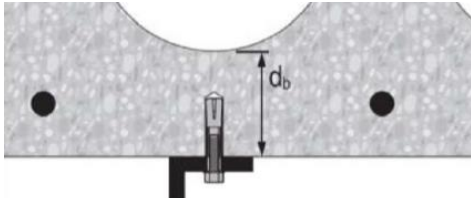

### 3.4.3 HKV

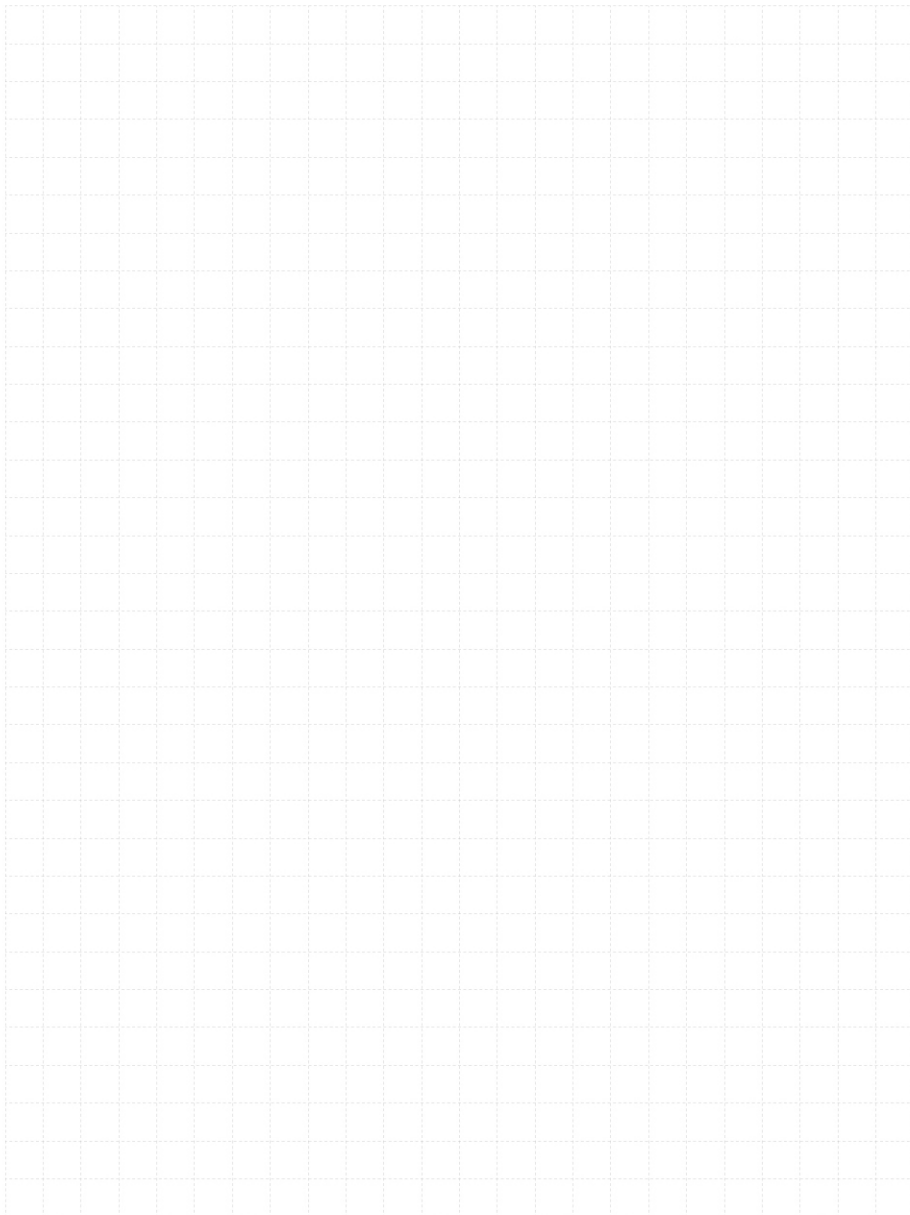

# HKV Flush anchors

## Economical manual set flush anchor

### Anchor version



HKV  
(M6-M16)

### Benefits

- Simple and well proven
- Approved, tested and confirmed by every day jobsite experience
- Reliable setting thanks to simple visual check
- Versatile
- For medium-duty fastening with bolts or threaded rods
- Available in various materials and sizes for maximized coverage of possible applications

### Base material



Concrete  
(non-cracked)

### Basic loading data (for a single anchor)

#### All data in this section applies to:

- Correct setting (See setting instruction)
- No edge distance and spacing influence
- Concrete as specified in the table
- Minimum base material thickness
- Concrete C 20/25,  $f_{ck,cube} = 25 \text{ N/mm}^2$
- Screw or rod with steel grade 5.8 (carbon steel) and / or A4-70 (stainless steel)

#### Effective anchorage depth

Anchor size	Metric		M6	M8	M10	M10	M12	M16
	Imperial		1/4	5/16	3/8	3/8	1/2	-
Effective anchorage depth	$h_{ef}$	[mm]	25	30	30	40	50	65

#### Characteristic resistance

Anchor size	Metric			M6	M8	M10	M10	M12	M16
	Imperial			1/4	5/16	3/8	3/8	1/2	-
Tension	HKV	$N_{Rk}$	[kN]	4,2	5,9	5,9	9,1	12,7	26,5
Shear	HKV	$V_{Rk}$	[kN]	5,0	8,6	10,0	11,0	18,3	33,8

#### Design resistance

Anchor size	Metric			M6	M8	M10	M10	M12	M16
	Imperial			1/4	5/16	3/8	3/8	1/2	-
Tension	HKV	$N_{Rd}$	[kN]	2,8	3,9	3,9	6,1	8,5	17,6
Shear	HKV	$V_{Rd}$	[kN]	5,0	8,6	8,0	8,0	14,6	27,0

**Recommended loads <sup>a)</sup>**

Anchor size	Metric		M6	M8	M10	M10	M12	M16
	Imperial		1/4	5/16	3/8	3/8	1/2	-
Tension	HKV	N <sub>Rec</sub> [kN]	2,0	2,8	2,8	4,3	6,0	12,6
Shear	HKV	V <sub>Rec</sub> [kN]	2,9	4,9	5,7	5,7	10,5	19,3

a) With overall partial safety factor for action  $\gamma = 1,4$ . The partial safety factors for action depend on the type of loading and shall be taken from national regulations

**Materials**
**Mechanical properties**

Anchor size	Metric		M6	M8	M10	M10	M12	M16
	Imperial		1/4	5/16	3/8	3/8	1/2	-
Nominal tensile strength	f <sub>uk</sub>	[N/mm <sup>2</sup> ]	570	570	570	570	570	640
Yield strength	f <sub>yk</sub>	[N/mm <sup>2</sup> ]	460	460	460	460	460	510
<b>Properties for metric anchors versions</b>								
Stressed cross-section	A <sub>s</sub>	[mm <sup>2</sup> ]	20,7	26,7	32,7	32,7	60,1	105
Moment of resistance	W	[mm <sup>3</sup> ]	32,3	54,6	82,9	82,9	184	431
Char. bending resistance for rod or bolt with 5.8 steel grade	M <sup>0</sup> <sub>Rk,s</sub>	[Nm]	7,6	18,7	37,4	37,4	65,5	167
<b>Properties for imperial anchors versions</b>								
Stressed cross-section	A <sub>s</sub>	[mm <sup>2</sup> ]	17,3	27,46	39,9	39,9	70,6	-
Moment of resistance	W	[mm <sup>3</sup> ]	28,2	55,8	97,4	97,4	229,8	
Char. bending resistance for rod or bolt with 5.8 steel grade	M <sup>0</sup> <sub>Rk,s</sub>	[Nm]	10,4	16,5	23,9	24,5	42,4	

**Material quality**

Part	Material
Anchor body	Steel Fe/Zn5 galvanized to min. 5 $\mu$ m
Expansion plug	Steel material

**Anchor dimension**

Anchor size	Metric		M6	M8	M10	M10	M12	M16
	Imperial		1/4	5/16	3/8	3/8	1/2	-
Effective anchorage depth	h <sub>ef</sub>	[mm]	25	30	30	40	50	65
<b>Dimensions for metric anchors versions</b>								
Anchor diameter	d <sub>1</sub>	[mm]	7,9	9,95	11,8	11,95	14,9	19,75
Diameter of cone bolt	d <sub>2</sub>	[mm]	5,1	6,5	8,2	8,2	10,3	13,8
Length of expansion sleeve	l <sub>1</sub>	[mm]	10	12	12	16	20	29
<b>Dimensions for imperial anchors versions</b>								
Anchor diameter	d <sub>1</sub>	[mm]	7,9	9,9	11,9	11,95	15,85	-
Diameter of cone bolt	d <sub>2</sub>	[mm]	5,1	6,35	8,2	7,86	10,2	-
Length of expansion sleeve	l <sub>1</sub>	[mm]	10	12	12	16,2	20	-

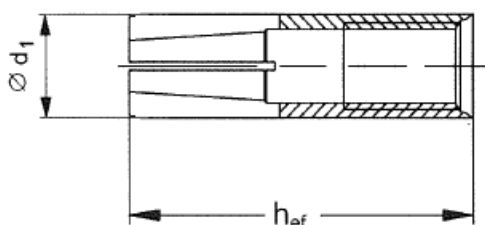
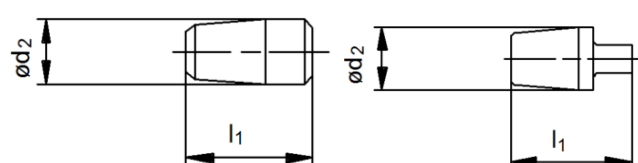
**Anchor body**

**Expansion plugs**

## Setting information

### Setting details

Anchor size	Metric		M6	M8	M10	M10	M12	M16
	Imperial		1/4	5/16	3/8	3/8	1/2	-
Effective anchorage depth	$h_{ef}$	[mm]	25	30	30	40	50	65
Nominal diameter of drill bit <sup>a)</sup>	$d_0$	[mm]	8	10	12	12	15 (16)	20
Cutting diameter of drill bit <sup>a)</sup>	$d_{cut} \leq$	[mm]	8,45	10,5	13 (12,5)	12,5	15,5 (16,5)	20,5
Depth of drill hole	$h_1 \geq$	[mm]	27	33	33	43	54	70
Diameter of clearance hole in the fixture	$d_f \leq$	[mm]	7	9	12	12	14	18
Torque moment	$T_{inst}$	[Nm]	4	8	15	15	35	60
Screwing depth	$l_{s,min}$	[mm]	6	8	10	10	12	16
	$l_{s,max}$	mm]	10	12	10,5	15,5	20,0	25,5

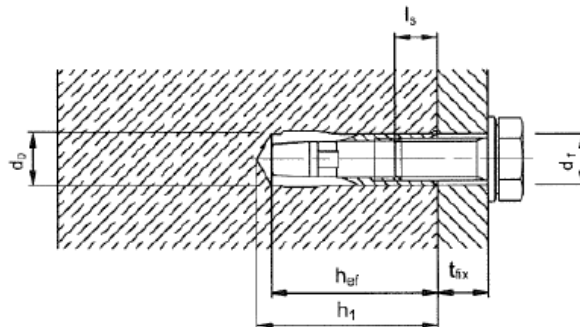
a) Values in brackets are applicable for imperial anchor versions



### Setting parameters

Anchor size	Metric		M6	M8	M10	M10	M12	M16
	Imperial		1/4	5/16	3/8	3/8	1/2	-
Minimum base material thickness	$h_{min} \geq$	[mm]	100	100	100	100	100	130
Minimum spacing	$s_{min} \geq$	[mm]	200	200	200	200	200	260
Minimum edge distance	$c_{min} \geq$	[mm]	150	150	150	150	150	195

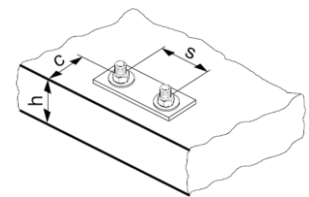

**Installation equipment**

Anchor size	Metric	M6	M8	M10	M10	M12	M16
	Imperial	1/4	5/16	3/8	3/8	1/2	-
Rotary hammer for setting	TE 1 – TE 30					TE 16 – TE 50	
	TE 1 – TE 30						-
Other tools	hammer, torque wrench, blow out pump						
<b>Metric anchors versions</b>							
Machine setting tool	HSD-M	6x25/30	8x25/30	10x25/30	10x40	12x50	16x65
Hand setting tool	HSD-G	6x25/30	8x25/30	10x25/30	10x40	12x50	16x65
<b>Imperial anchors versions</b>							
Machine setting tool	HSD-M	1/4x25	5/16x30	3/8x30	3/8x40	1/2x50	-
Hand setting tool	HSD-G	1/4x25	5/16x30	3/8x30	3/8x40	1/2x50	-

**Setting instruction**

\*For detailed information on installation see instruction for use given with the package of the product.

Setting instruction	
<b>1. Drilling</b> 	<b>2. Cleaning</b> 
<b>3. Inserting the anchor</b> 	<b>4. Setting tools</b> 
<b>5. Inserting the tools</b> 	<b>6. Inserting the tools</b> 
<b>7. Attaching the belonging washer</b> 	<b>8.</b> 



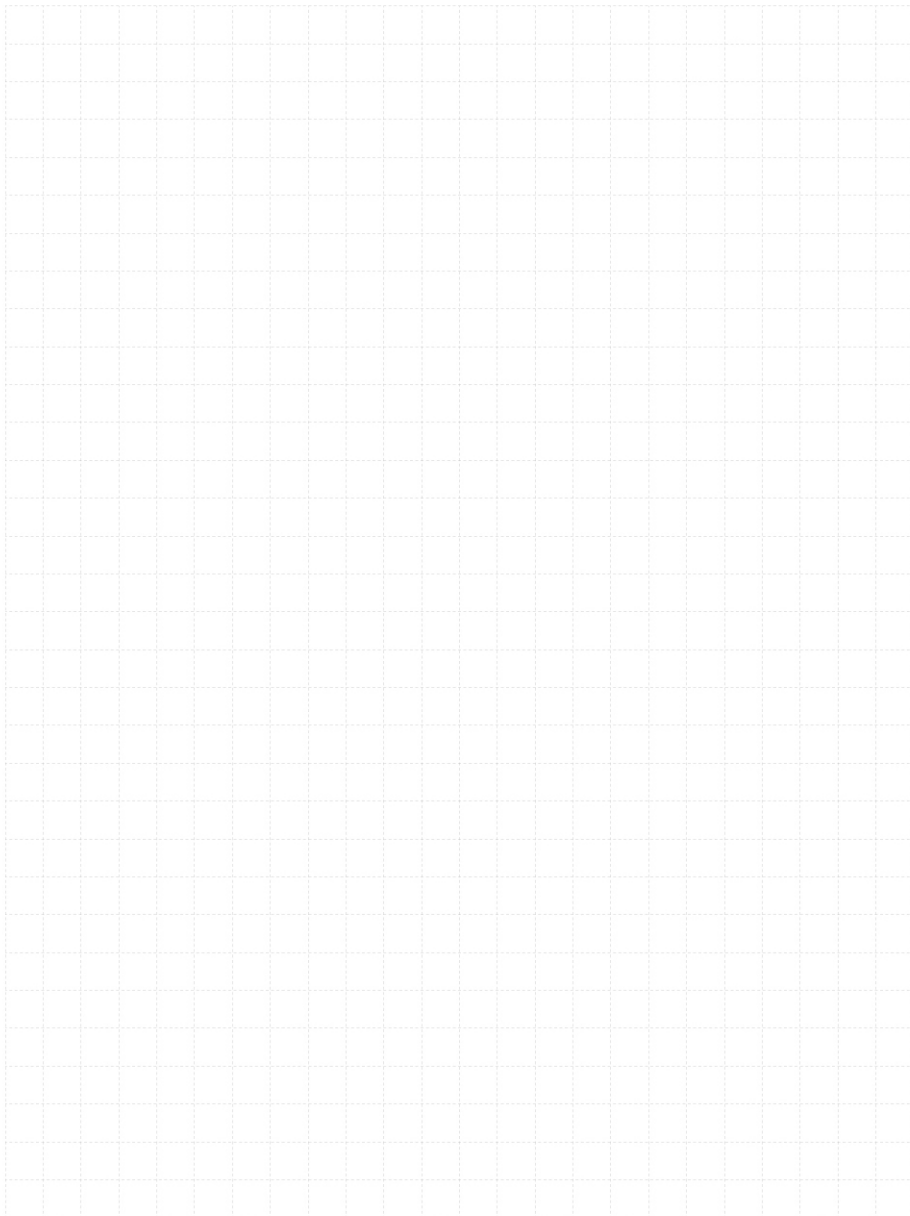

## 3.5 Plastic anchors

### 3.5.1 HRD



# HRD Plastic frame anchors

## Everyday standard plastic frame anchor for single use applications

Anchor version	Benefits
 HRD-C HRD-CR HRD-CR2 (d10)	<ul style="list-style-type: none"> <li>- Innovative screw design for better hold</li> <li>- Suitable on practically all base materials</li> </ul>
 HRD-H HRD-HR HRD-HR2 HR-HF (d10)	<ul style="list-style-type: none"> <li>- Flexible embedment depth (approved at 50mm and 70mm)</li> <li>- Suitable for fastening thicknesses up to 260mm</li> <li>- Available in 4 different materials for optimum suitability in all corrosive environments</li> </ul>
 HRD-K HRD-KR HRD-KR2 (d10)	<ul style="list-style-type: none"> <li>- Pre-assembled for optimum handling and fastening quality</li> </ul>
 HRD-P HRD-PR HRD-PR2 (d10)	

### Base material



Concrete  
(non-cracked)

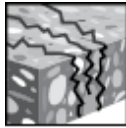

Concrete  
(cracked)

### Approvals / certificates

Description	Authority / Laboratory	No./ date of issue
Allgemeine bauaufsichtliche Zulassung <sup>a)</sup> (German approval)	DIBt, Berlin	Z-21.2-2034 / 2019-11-15

a) All data given in this section according Z-21.2-2034, issue 2019-11-15.



**Basic loading data**
**All data in this section applies to:**

- Correct setting (See setting instruction)
- No edge distance and spacing influence
- Steel failure
- Base material as specified in the table
- Minimum base material thickness
- Shear without lever arm
- Use at max. temperature of +30°C(long term) or +50°C (short term)

**Characteristic resistance**

Anchor type		HRD 10		
Anchor screw material		Galvanized steel	Hot-dip galvanized steel	Stainless steel
<b>Non-cracked concrete</b>				
Tension	$N_{Rk}$ [kN]	14,9	14,9	14,9
Shear	$V_{Rk}$ [kN]	10,6	10,1	11,1
<b>Cracked concrete</b>				
Tension	$N_{Rk}$ [kN]	4,3	4,3	4,3
Shear	$V_{Rk}$ [kN]	8,6	8,6	8,6

**Design resistance**

Anchor type		HRD 10		
Anchor screw material		Galvanized steel	Hot-dip galvanized steel	Stainless steel
<b>Non-cracked concrete</b>				
Tension	$N_{Rd}$ [kN]	5,9	5,9	5,9
Shear	$V_{Rd}$ [kN]	8,5	8,1	8,5
<b>Cracked concrete</b>				
Tension	$N_{Rd}$ [kN]	1,7	1,7	1,7
Shear	$V_{Rd}$ [kN]	4,8	4,8	4,8

**Recommended loads <sup>a)</sup>**

Anchor type		HRD 10		
Anchor screw material		Galvanized steel	Hot-dip galvanized steel	Stainless steel
<b>Non-cracked concrete</b>				
Tension	$N_{Rec}$ [kN]	4,2	4,2	4,2
Shear	$V_{Rec}$ [kN]	6,1	5,8	6,1
<b>Cracked concrete</b>				
Tension	$N_{Rec}$ [kN]	1,2	1,2	1,2
Shear	$V_{Rec}$ [kN]	3,4	3,4	3,4

a) With overall partial safety factor for action  $\gamma = 1,4$ . The partial safety factors for action depend on the type of loading and shall be taken from national regulations.

## Materials

### Mechanical properties

Anchor type			HRD 10		
Anchor screw material			Galvanized steel	Hot-dip galvanized steel	Stainless steel
Nominal tensile strength	$f_{uk}$	[N/mm <sup>2</sup> ]	600	600	630
Yield strength	$f_{yk}$	[N/mm <sup>2</sup> ]	480	480	480
Stressed cross-section	$A_s$	[mm <sup>2</sup> ]	35,3	33,7	35,3
Moment of resistance	$W$	[mm <sup>3</sup> ]	29,5	27,6	29,5
Characteristic bending resistance	$M^{0}_{Rk,s}$	[Nm]	21,3	19,9	22,3

### Material quality

Part		Material
Sleeve		Polyamide, color red
Screw	HRD-C, -H, -K, -P	Carbon steel, galvanized to min.5 $\mu$ m
	HRD-HF	Carbon steel, hot-dip galvanized to min. 65 $\mu$ m
	HRD-CR2, -HR2, -KR2, -PR2	Stainless steel, corrosion class II: 1.4301 / 1.4567
	HRD-CR, -HR, -KR, -PR	Stainless steel, corrosion class III: 1.4362/1.4401/1.4404/1.4571

### Anchor dimension

Anchor size			HRD 10
Minimum thickness of fixture	$t_{fix,min}$	[mm]	0
Maximum thickness of fixture	$t_{fix,max}$	[mm]	260
Diameter of the sleeve	$d_{nom}$	[mm]	10
Minimum length of the sleeve	$l_{1,min}$	[mm]	60
Maximum length of the sleeve	$l_{1,max}$	[mm]	310
Diameter of plastic washer	$d_{pw}$	[mm]	17,5
Thickness of plastic washer	$t_{pw}$	[mm]	2
Diameter of the screw	$d_s$	[mm]	7
Minimum length of the screw	$l_{2,min}$	[mm]	65
Maximum length of the screw	$l_{2,max}$	[mm]	315
Head diameter of countersunk screw	$d_{sc}$	[mm]	14
Head diameter of hexhead screw	$d_{sw}$	[mm]	17,5
Length of threaded section	$L_t$	[mm]	70

### Anchor sleeve

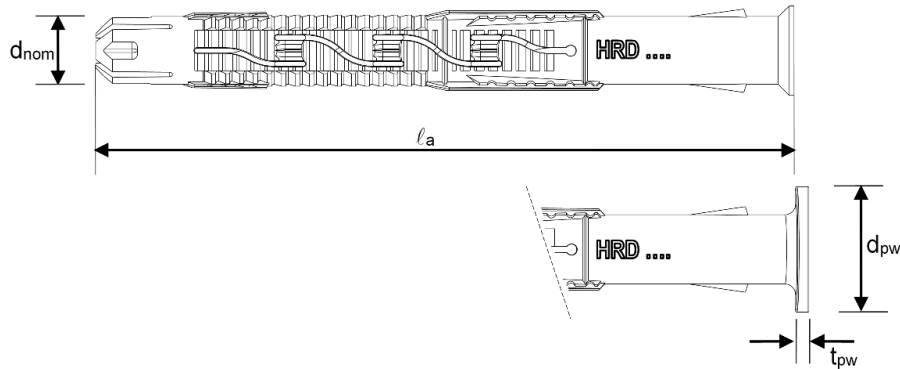

### Special screw

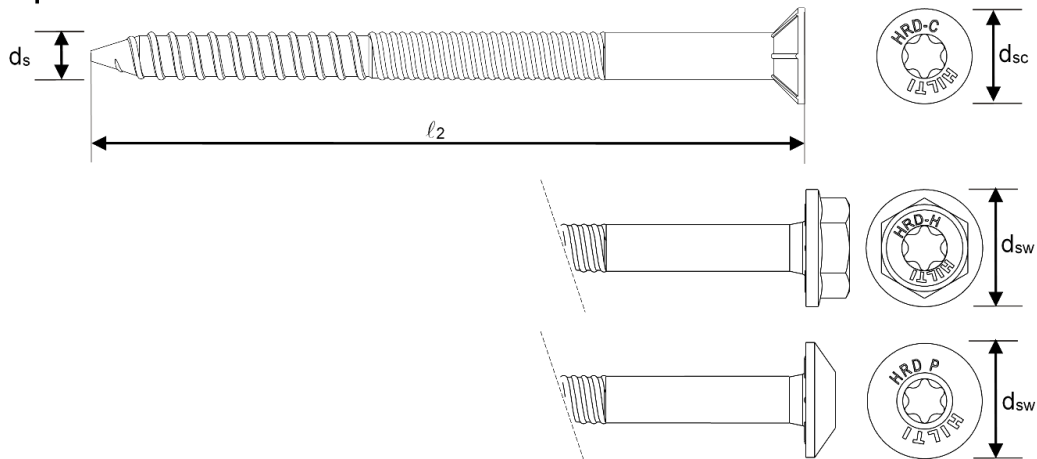

## Setting information

### Installation temperature

-10°C to +40°C

### Service temperature range

Hilti HRD frame anchors may be applied in the temperature range given below.

Temperature range	Base material temperature	Max. long term base material temperature	Max. short term base material temperature
Temperature range I	-40 °C to +50 °C	+30 °C	+50 °C
Temperature range II	-40 °C to +80 °C	+50 °C	+80 °C

### Max short term base material temperature

Short-term elevated base material temperatures are those that occur over brief intervals, e.g. as a result of diurnal cycling.

### Max long term base material temperature

Long-term elevated base material temperatures are roughly constant over significant periods of time.

**Setting details**

Anchor size			HRD 10
Drill hole diameter	$d_o$	[mm]	10
Cutting diameter of drill bit	$d_{cut} \leq$	[mm]	10,45
Depth of drilled hole to deepest point	$h_1 \geq$	[mm]	80
Overall plastic anchor embedment depth in base material	$h_{nom} \geq$	[mm]	70
Diameter of clearance hole in the fixture	Countersunk screw	$d_f \leq$	11
	Hexhead screw	$d_f \leq$	12

**Setting parameters**

Anchor size			HRD 10	
		$h_{nom}$	70	
Minimum base material thickness	Concrete	$h_{min}$	120	
Minimum spacing <sup>a)</sup>	Concrete $\geq$ C20/25	$s_{min}$	50	
		for $c \geq$	100	
Minimum edge distance <sup>a)</sup>	Concrete $\geq$ C20/25	$c_{min}$	50	
		for $s \geq$	150	
Critical spacing for splitting failure	Concrete $\geq$ C20/25	$s_{cr,sp}$	300	
Critical edge distance for splitting failure	Concrete $\geq$ C20/25	$c_{cr,sp}$	150	
<b>Concrete</b>			<b>Non-cracked</b>	<b>Cracked</b>
Critical spacing for concrete cone failure	Concrete $\geq$ C20/25	$s_{cr,N}$	135	75
Critical edge distance for concrete cone failure	Concrete $\geq$ C20/25	$c_{cr,N}$	38	68

a) Linear interpolation allowed

For spacing (edge distance) smaller than critical spacing (critical edge distance) the design loads have to be reduced.

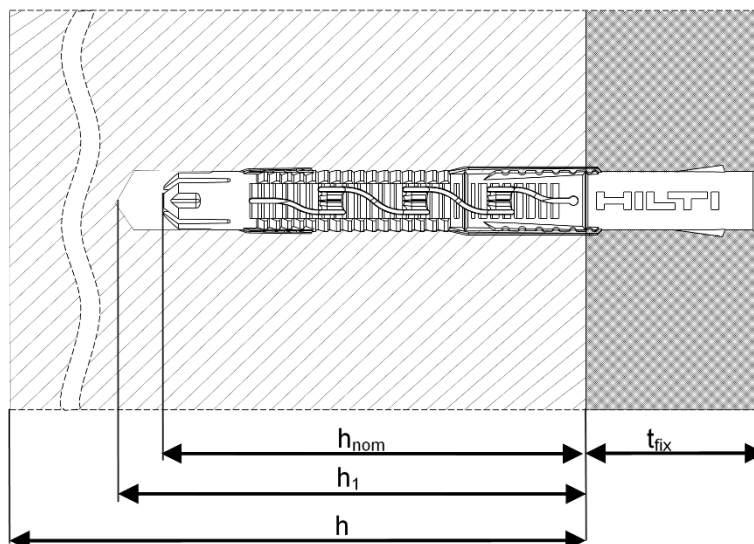
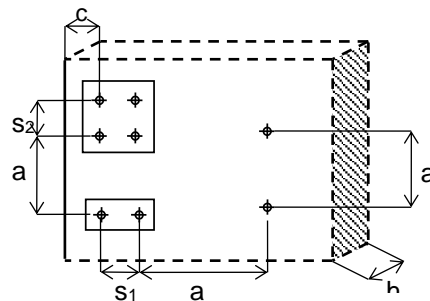

**Installation equipment**

Anchor size	HRD 10
Rotary hammer	TE 2 (-A) - TE16 (-A)
Other tools	Hammer, Screwdriver

**Setting instruction**

\*For detailed information on installation see instruction for use given with the package of the product.



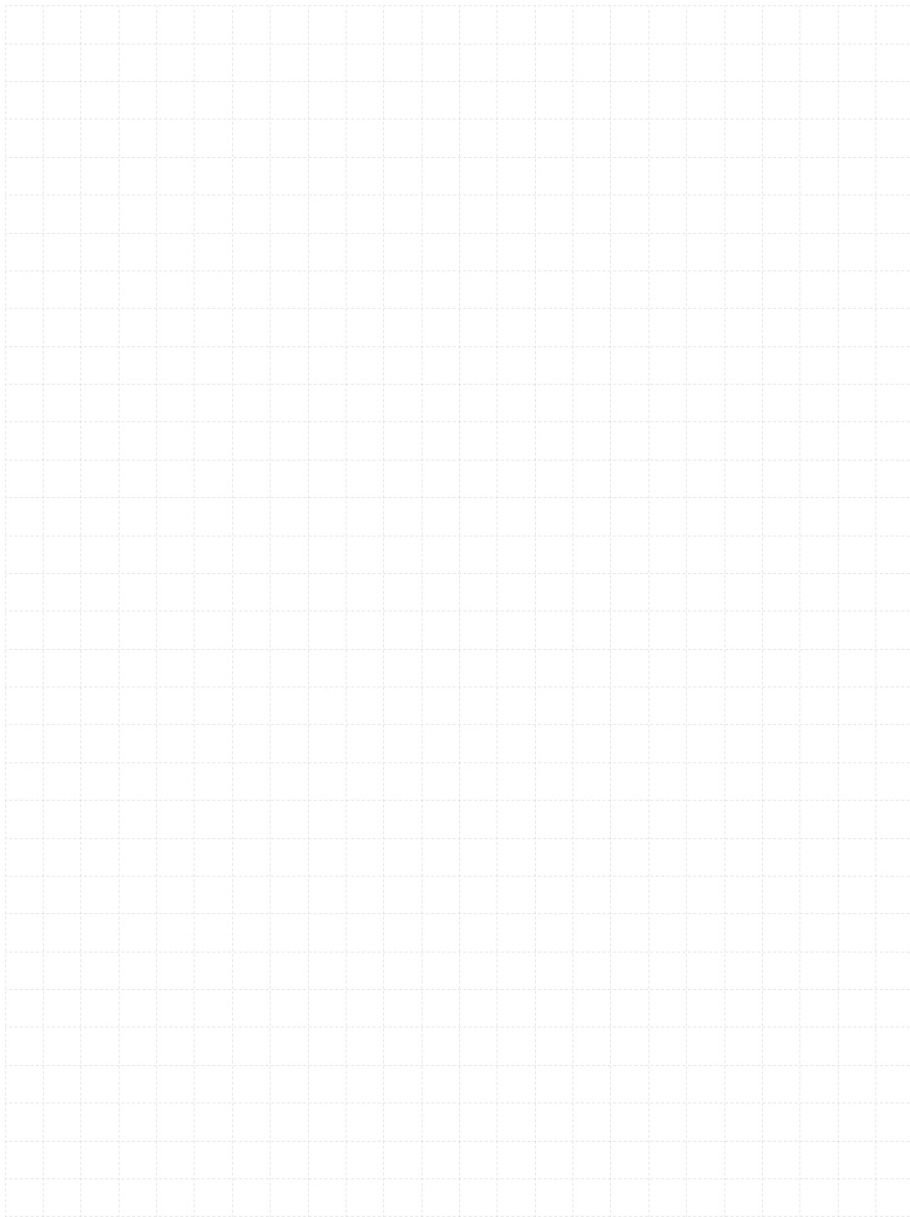

Setting instruction for HRD	
<p><b>1. Drilling</b></p>	<p><b>2. Cleaning</b></p>
<p><b>3. Inserting the anchor</b></p>	<p><b>4. Inserting the anchor</b></p>
<p><b>5. Setting tools</b></p>	<p><b>6. Checking</b></p>

### 3.5.2 HRD redundant



# HRD Plastic frame anchors

## Everyday standard plastic frame anchor for redundant fastening applications

Anchor version	Benefits
 HRD-C HRD-CR (d8)	<ul style="list-style-type: none"> <li>- Innovative screw design for better hold</li> <li>- Suitable on practically all base materials</li> <li>- Flexible embedment depth (approved at 50mm and 70mm)</li> <li>- Suitable for fastening thicknesses up to 260mm</li> <li>- Available in 4 different materials for optimum suitability in all corrosive environments</li> <li>- Pre-assembled for optimum handling and fastening quality</li> </ul>
 HRD-C HRD-CR HRD-CR2 (d10)	
 HRD-H HRD-HR HRD-HR2 HR-HF (d10)	
 HRD-K HRD-KR HRD-KR2 (d10)	
 HRD-P HRD-PR HRD-PR2 (d10)	

### Base material

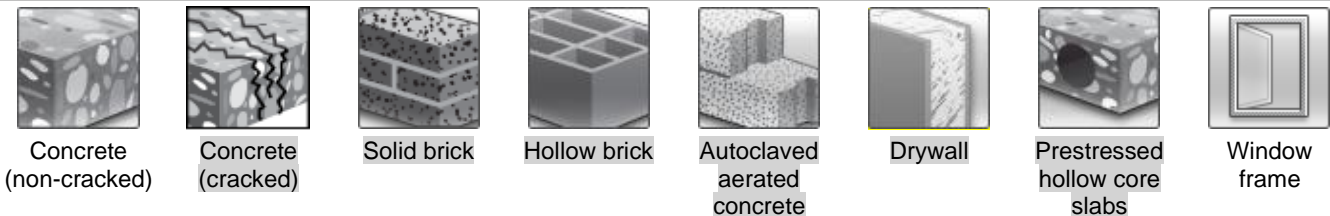

### Load conditions

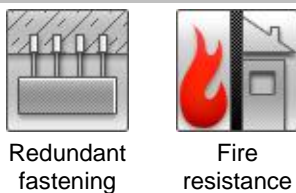

### Other information



### Approvals / certificates

Description	Authority / Laboratory	No./ date of issue
European technical approval <sup>a)</sup>	DIBt, Berlin	ETA-07/0219 / 2018-06-28
Fire test report	MFPA, Leipzig	GS 3.2/10-157-1/ 2010-09-02
Window frame report <sup>b)</sup>	Ift, Rosenheim	Ift report 105 33035 / 2007-07-09

a) All data given in this section according ETA-07/0219, issue 2017-09-19. The anchor is to be used only for redundant fastening for non-structural applications.

b) Only available for HRD 8

**Basic loading data**
**All data in this section applies to:**

- Correct setting (See setting instruction)
- No edge distance and spacing influence
- Base material as specified in the table
- Minimum base material thickness
- Steel failure
- Shear without lever arm
- Anchor in redundant fastening

The additional Hilti recommended data, not part of the approval

**Characteristic resistance for concrete**

Anchor size			HRD 8	HRD 10		
		$h_{nom}$ [mm]	50	50	70	90
<b>Concrete C12/15</b>						
Tension	HRD	$N_{Rk}$ [kN]	2,0	3,0	6,0	-
	HRD-F		- a)	3,0	6,0	-
	HRD-R2 / HRD-R		2,0	3,0	6,0	-
Shear	HRD	$V_{Rk}$ [kN]	6,9	10,6	10,6	-
	HRD-F		- a)	10,1	10,1	-
	HRD-R2 / HRD-R		6,6	11,1	11,1	-
<b>Concrete C16/20 – C 50/60</b>						
Tension	HRD	$N_{Rk}$ [kN]	3,0	4,5	8,5	-
	HRD-F		- a)	4,5	8,5	-
	HRD-R2 / HRD-R		3,0	4,5	8,5	-
Shear	HRD	$V_{Rk}$ [kN]	6,9	10,6	10,6	-
	HRD-F		- a)	10,1	10,1	-
	HRD-R2 / HRD-R		6,6	11,1	11,1	-
<b>Thin concrete skins <sup>b)</sup> C12/15</b>						
Tension	HRD / HRD-F / HRD-R2 / HRD-R	$N_{Rk}$ [kN]	-	2,5	-	-
<b>Thin concrete skins <sup>b)</sup> ≥C16/20</b>						
Tension	HRD / HRD-F / HRD-R2 / HRD-R	$N_{Rk}$ [kN]	-	3,5	-	-

a) HRD-F 8 is not available in standard portfolio

 b) Weather resistant skins of external wall panels) with  $h=40$  mm to 100 mm



**Design resistance for concrete**

Anchor size		$h_{nom}$ [mm]	HRD 8		HRD 10	
			50	50	70	90
<b>Concrete C12/15</b>						
Tension	HRD	$N_{Rk}$ [kN]	1,1	1,7	3,3	-
	HRD-F		- a)	1,7	3,3	-
	HRD-R2 / HRD-R		1,1	1,7	3,3	-
Shear	HRD	$V_{Rk}$ [kN]	5,5	8,5	8,5	-
	HRD-F		- a)	8,1	8,1	-
	HRD-R2 / HRD-R		5,2	8,5	8,5	-
<b>Concrete C16/20 – C 50/60</b>						
Tension	HRD	$N_{Rk}$ [kN]	1,7	2,5	4,7	-
	HRD-F		- a)	2,5	4,7	-
	HRD-R2 / HRD-R		1,7	2,5	4,7	-
Shear	HRD	$V_{Rk}$ [kN]	5,5	8,5	8,5	-
	HRD-F		- a)	8,1	8,1	-
	HRD-R2 / HRD-R		5,2	8,5	8,5	-
<b>Thin concrete skins <sup>b)</sup> C12/15</b>						
Tension	HRD / HRD-F / HRD-R2 / HRD-R	$N_{Rk}$ [kN]	-	1,4	-	-
<b>Thin concrete skins <sup>b)</sup> ≥C16/20</b>						
Tension	HRD / HRD-F / HRD-R2 / HRD-R	$N_{Rk}$ [kN]	-	2,5	-	-

a) HRD-F 8 is not available in standard portfolio

 b) Weather resistant skins of external wall panels) with  $h=40$  mm to 100 mm

**Recommended <sup>c)</sup> loads for concrete**

Anchor size		$h_{nom}$ [mm]	HRD 8		HRD 10		
			50	50	70	90	
<b>Concrete C12/15</b>							
Tension	HRD	$N_{Rd}$ [kN]	0,8	1,2	2,4	-	
	HRD-F		- a)	1,2	2,4	-	
	HRD-R2 / HRD-R		0,8	1,2	2,4	-	
Shear	HRD	$V_{Rd}$ [kN]	3,9	6,1	6,1	-	
	HRD-F		- a)	5,8	5,8	-	
	HRD-R2 / HRD-R		3,7	6,1	6,1	-	
<b>Concrete C16/20 – C 50/60</b>							
Tension	HRD	$N_{Rd}$ [kN]	1,2	1,8	3,4	-	
	HRD-F		- a)	1,8	3,4	-	
	HRD-R2 / HRD-R		1,2	1,8	3,4	-	
Shear	HRD	$V_{Rd}$ [kN]		6,1	6,1	-	
	HRD-F		- a)		5,8	5,8	-
	HRD-R2 / HRD-R			6,1	6,1	-	
<b>Thin concrete skins <sup>b)</sup> C12/15</b>							
Tension	HRD / HRD-F / HRD-R2 / HRD-R	$N_{Rk}$ [kN]	-	1,0	-	-	
<b>Thin concrete skins <sup>b)</sup> ≥C16/20</b>							
Tension	HRD / HRD-F / HRD-R2 / HRD-R	$N_{Rk}$ [kN]	-	1,8	-	-	

a) HRD-F 8 is not available in standard portfolio

 b) Weather resistant skins of external wall panels) with  $h=40$  mm to 100 mm

 c) With overall partial safety factor for action  $\gamma = 1.4$ , The partial safety factors for action depend on the type of loading and shall be taken from national regulations.

**Characteristic resistance for masonry (Part 1)**

Anchor size			HRD 8		HRD 10		
			50 <sup>d)</sup>	50 <sup>d)</sup>	70 <sup>d)</sup>	90	
$h_{nom}$ [mm]							
Solid clay brick Mz 2,0 DIN V 105-100/EN 771-1	$f_b \geq 20 \text{ N/mm}^2$	$F_{Rk}$ [kN]	1,5	3,0	c)	-	
				4,5 <sup>a)</sup>			
	$f_b \geq 10 \text{ N/mm}^2$	$F_{Rk}$ [kN]	1,2	2,0	c)		
				3,0 <sup>a)</sup>			
Solid sand-lime brick KS 2,0 DIN V 106 /EN 771-2	$f_b \geq 20 \text{ N/mm}^2$	$F_{Rk}$ [kN]	2,5	3,0	c)	-	
				4,5 <sup>a)</sup>			
	$f_b \geq 10 \text{ N/mm}^2$	$F_{Rk}$ [kN]	2,0	2,0	c)	-	
				3,0 <sup>a)</sup>			
Lightweight solid block Vbl 0,9 DIN V 18151-100/EN 771	$f_b \geq 20 \text{ N/mm}^2$	$F_{Rk}$ [kN]	-	3,5	c)	-	
				6,0 <sup>a)</sup>			
	$f_b \geq 10 \text{ N/mm}^2$	$F_{Rk}$ [kN]		2,5			
			4,5 <sup>a)</sup>	c)	-		
	$f_b \geq 2 \text{ N/mm}^2$	$F_{Rk}$ [kN]	0,5	-	-	-	
Ital. solid brick Tufo	$f_b \geq n/a$	$F_{Rk}$ [kN]	1,4	-	-	-	
Hollow clay brick Hz B 12/1,2 Brick <b>A</b> <sup>b)</sup>	$f_b \geq 12 \text{ N/mm}^2$	$F_{Rk}$ [kN]	0,5	-	-	-	
Vertic. perforated clay brick Hz 1,2-2DF Brick <b>F</b> <sup>b)</sup>	$f_b \geq 8 \text{ N/mm}^2$	$F_{Rk}$ [kN]	-	1,5	-	-	
	$f_b \geq 10 \text{ N/mm}^2$	$F_{Rk}$ [kN]	-	2,0	-	-	
	$f_b \geq 12 \text{ N/mm}^2$	$F_{Rk}$ [kN]	-	2,0	-	-	
Vertic. perforated clay brick Hz 1,0-2DF Brick <b>G</b> <sup>b)</sup>	$f_b \geq 8 \text{ N/mm}^2$	$F_{Rk}$ [kN]	-	0,4	0,75	-	
	$f_b \geq 10 \text{ N/mm}^2$	$F_{Rk}$ [kN]	-	0,5	0,9	-	
	$f_b \geq 12 \text{ N/mm}^2$	$F_{Rk}$ [kN]	-	0,6	0,9	-	
	$f_b \geq 20 \text{ N/mm}^2$	$F_{Rk}$ [kN]	-	0,9	1,5	-	
Vertic. perforated clay brick Hz 1,0-2DF Brick <b>H</b> <sup>b)</sup>	$f_b \geq 28 \text{ N/mm}^2$	$F_{Rk}$ [kN]	-	2,0	2,5	-	
	$f_b \geq 50 \text{ N/mm}^2$	$F_{Rk}$ [kN]	-	3,0	3,5	-	
Vertic. perforated clay brick Poroton T8 Brick <b>M</b> <sup>b)</sup>	$f_b \geq 6 \text{ N/mm}^2$	$F_{Rk}$ [kN]	-	0,75	1,5	-	
Vertic. perforated clay brick Hz 1,0-9DF Brick <b>L</b> <sup>b)</sup>	$f_b \geq 8 \text{ N/mm}^2$	$F_{Rk}$ [kN]	-	1,2	1,5	-	
	$f_b \geq 10 \text{ N/mm}^2$	$F_{Rk}$ [kN]	-	1,5	1,5	-	
	$f_b \geq 12 \text{ N/mm}^2$	$F_{Rk}$ [kN]	-	1,5	2,0	-	
	$f_b \geq 16 \text{ N/mm}^2$	$F_{Rk}$ [kN]	-	2,0	2,5	-	

- a) Valid for edge distance  $c \geq 150 \text{ mm}$ , intermediate values can be interpolated.  
 b) Specification on hollow base material brick types see separate table below.  
 c) Data can be determined by job-site testing, data for  $h_{nom}=50 \text{ mm}$  can be applied.  
 d) The influence of  $h_{nom} > 50 \text{ mm}$  (HRD 8) or  $h_{nom,1} > 50 \text{ mm}$  or  $h_{nom,2} > 70 \text{ mm}$  (HRD 10) has to be checked by job-site testing

**Characteristic resistance for masonry (Part 2)**

Anchor size		$h_{nom}$ [mm]		HRD 8		HRD 10		
				50 <sup>d)</sup>	50 <sup>d)</sup>	70 <sup>d)</sup>	90	
Hollow sand-lime brick KSL 12/1,4 Brick <b>O<sup>b)</sup></b>	$f_b \geq 12 \text{ N/mm}^2$	$F_{Rk}$	[kN]	0,75	-	-	-	-
Vertic. perforated clay brick Hz 1,6-2DF Brick <b>P<sup>b)</sup></b>	$f_b \geq 8 \text{ N/mm}^2$	$F_{Rk}$	[kN]	-	1,5	-	-	-
	$f_b \geq 10 \text{ N/mm}^2$	$F_{Rk}$	[kN]	-	1,5	-	-	-
	$f_b \geq 12 \text{ N/mm}^2$	$F_{Rk}$	[kN]	-	2,0	-	-	-
Vertic. perforated clay brick Hz 1,6-2DF Brick <b>Q<sup>b)</sup></b>	$f_b \geq 8 \text{ N/mm}^2$	$F_{Rk}$	[kN]	-	-	2,0	-	-
	$f_b \geq 10 \text{ N/mm}^2$	$F_{Rk}$	[kN]	-	-	2,5	-	-
	$f_b \geq 12 \text{ N/mm}^2$	$F_{Rk}$	[kN]	-	-	3,0	-	-
Vertic. perforated clay brick KSL R 1,6-16DF Brick <b>R<sup>b)</sup></b>	$f_b \geq 8 \text{ N/mm}^2$	$F_{Rk}$	[kN]	-	0,9	1,2	-	-
	$f_b \geq 10 \text{ N/mm}^2$	$F_{Rk}$	[kN]	-	1,2	1,5	-	-
	$f_b \geq 12 \text{ N/mm}^2$	$F_{Rk}$	[kN]	-	1,5	2,0	-	-
	$f_b \geq 16 \text{ N/mm}^2$	$F_{Rk}$	[kN]	-	2,0	2,5	-	-
Lightweight hollow brick Hbl B 2/0,8 Brick <b>S<sup>b)</sup></b>	$f_b \geq 2 \text{ N/mm}^2$	$F_{Rk}$	[kN]	0,30	-	-	-	-
Lightweight concrete hollow block Hbl 1,2-12DF Brick <b>T<sup>b)</sup></b>	$f_b \geq 2 \text{ N/mm}^2$	$F_{Rk}$	[kN]	-	0,5	0,75	-	-
	$f_b \geq 6 \text{ N/mm}^2$	$F_{Rk}$	[kN]	-	1,2	2,0	-	-
Ital. hollow brick Poroton P700 Brick <b>N<sup>b)</sup></b>	$f_b \geq 15 \text{ N/mm}^2$	$F_{Rk}$	[kN]	1,5	- <sup>c)</sup>	0,6	-	-
Ital. hollow brick Doppio Uni Brick <b>C+I<sup>b)</sup></b>	$f_b \geq 25 \text{ N/mm}^2$	$F_{Rk}$	[kN]	0,9 (C)	- <sup>c)</sup> (I)	1,5 (I)	-	-
Span. hollow brick Rojo hidrofugano Brick <b>D<sup>b)</sup></b>	$f_b \geq 40 \text{ N/mm}^2$	$F_{Rk}$	[kN]	0,6	-	-	-	-
Span. hollow brick Ladrillo perforado Brick <b>J<sup>b)</sup></b>	$f_b \geq 26 \text{ N/mm}^2$	$F_{Rk}$	[kN]	-	1,5	2,0	-	-
Span. hollow brick Clinker mediterraneo Brick <b>K<sup>b)</sup></b>	$f_b \geq 75 \text{ N/mm}^2$	$F_{Rk}$	[kN]	-	- <sup>c)</sup>	1,5	-	-
French hollow brick Brique Creuse <b>B<sup>b)</sup></b>	$f_b \geq 6 \text{ N/mm}^2$	$F_{Rk}$	[kN]	0,50	-	-	-	-

a) Valid for edge distance  $c \geq 150 \text{ mm}$ , intermediate values can be interpolated.

b) Specification on hollow base material brick types see separate table below.

c) Data can be determined by job-site testing, data for  $h_{nom}=50 \text{ mm}$  can be applied.

d) The influence of  $h_{nom} > 50 \text{ mm}$  (HRD 8) or  $h_{nom,1} > 50 \text{ mm}$  or  $h_{nom,2} > 70 \text{ mm}$  (HRD 10) has to be checked by job-site testing

**Design resistance for masonry (Part 1)**

Anchor size			HRD 8		HRD 10		
			50 <sup>d)</sup>	50 <sup>d)</sup>	70 <sup>d)</sup>	90	
Solid clay brick Mz 2,0 DIN V 105-100/EN 771-1	$f_b \geq 20 \text{ N/mm}^2$	$F_{Rd}$ [kN]	0,6	1,2	c)	-	
				1,8 <sup>a)</sup>			
	$f_b \geq 10 \text{ N/mm}^2$	$F_{Rd}$ [kN]	0,48	0,8	c)		
				1,2 <sup>a)</sup>			
Solid sand-lime brick KS 2,0 DIN V 106 /EN 771-2	$f_b \geq 20 \text{ N/mm}^2$	$F_{Rd}$ [kN]	1,0	1,2	c)	-	
				1,8 <sup>a)</sup>			
	$f_b \geq 10 \text{ N/mm}^2$	$F_{Rd}$ [kN]	0,8	0,8	c)	-	
				1,2 <sup>a)</sup>			
Lightweight solid block Vbl 0,9 DIN V 18151-100/EN 771	$f_b \geq 20 \text{ N/mm}^2$	$F_{Rd}$ [kN]	-	1,4	c)	-	
				2,4 <sup>a)</sup>			
	$f_b \geq 10 \text{ N/mm}^2$	$F_{Rd}$ [kN]		-			1,0
			1,8 <sup>a)</sup>				
	$f_b \geq 2 \text{ N/mm}^2$	$F_{Rd}$ [kN]	0,2	-	-	-	
Ital. solid brick Tufo	$f_b \geq n/a$	$F_{Rd}$ [kN]	0,56	-	-	-	
Hollow clay brick Hz B 12/1,2 Brick <b>A</b> <sup>b)</sup>	$f_b \geq 12 \text{ N/mm}^2$	$F_{Rd}$ [kN]	0,2	-	-	-	
Vertic. perforated clay brick Hz 1,2-2DF Brick <b>F</b> <sup>b)</sup>	$f_b \geq 8 \text{ N/mm}^2$	$F_{Rd}$ [kN]	-	0,6	-	-	
	$f_b \geq 10 \text{ N/mm}^2$	$F_{Rd}$ [kN]	-	0,8	-	-	
	$f_b \geq 12 \text{ N/mm}^2$	$F_{Rd}$ [kN]	-	0,8	-	-	
Vertic. perforated clay brick Hz 1,0-2DF Brick <b>G</b> <sup>b)</sup>	$f_b \geq 8 \text{ N/mm}^2$	$F_{Rd}$ [kN]	-	0,16	0,3	-	
	$f_b \geq 10 \text{ N/mm}^2$	$F_{Rd}$ [kN]	-	0,2	0,36	-	
	$f_b \geq 12 \text{ N/mm}^2$	$F_{Rd}$ [kN]	-	0,24	0,36	-	
	$f_b \geq 20 \text{ N/mm}^2$	$F_{Rd}$ [kN]	-	0,36	0,6	-	
Vertic. perforated clay brick Hz 1,0-2DF Brick <b>H</b> <sup>b)</sup>	$f_b \geq 28 \text{ N/mm}^2$	$F_{Rd}$ [kN]	-	0,8	1,0	-	
	$f_b \geq 50 \text{ N/mm}^2$	$F_{Rd}$ [kN]	-	1,2	1,4	-	
Vertic. perforated clay brick Poroton T8 Brick <b>M</b> <sup>b)</sup>	$f_b \geq 6 \text{ N/mm}^2$	$F_{Rd}$ [kN]	-	0,3	0,6	-	
Vertic. perforated clay brick Hz 1,0-9DF Brick <b>L</b> <sup>b)</sup>	$f_b \geq 8 \text{ N/mm}^2$	$F_{Rd}$ [kN]	-	0,48	0,6	-	
	$f_b \geq 10 \text{ N/mm}^2$	$F_{Rd}$ [kN]	-	0,6	0,6	-	
	$f_b \geq 12 \text{ N/mm}^2$	$F_{Rd}$ [kN]	-	0,6	0,8	-	
	$f_b \geq 16 \text{ N/mm}^2$	$F_{Rd}$ [kN]	-	0,8	1,0	-	

a) Valid for edge distance  $c \geq 150 \text{ mm}$ , intermediate values can be interpolated.

b) Specification on hollow base material brick types see separate table below.

c) Data can be determined by job-site testing, data for  $h_{nom}=50 \text{ mm}$  can be applied.

d) The influence of  $h_{nom} > 50 \text{ mm}$  (HRD 8) or  $h_{nom,1} > 50 \text{ mm}$  or  $h_{nom,2} > 70 \text{ mm}$  (HRD 10) has to be checked by job-site testing

**Design resistance for masonry (Part 2)**

Anchor size		$h_{nom}$ [mm]		HRD 8		HRD 10		
				50 <sup>d)</sup>	50 <sup>d)</sup>	70 <sup>d)</sup>	90	
Hollow sand-lime brick KSL 12/1,4 Brick <b>O<sup>b)</sup></b>	$f_b \geq 12 \text{ N/mm}^2$	$F_{Rd}$	[kN]	0,3	-	-	-	-
Vertic. perforated clay brick Hz 1,6-2DF Brick <b>P<sup>b)</sup></b>	$f_b \geq 8 \text{ N/mm}^2$	$F_{Rd}$	[kN]	-	0,6	-	-	-
	$f_b \geq 10 \text{ N/mm}^2$	$F_{Rd}$	[kN]	-	0,6	-	-	-
	$f_b \geq 12 \text{ N/mm}^2$	$F_{Rd}$	[kN]	-	0,8	-	-	-
Vertic. perforated clay brick Hz 1,6-2DF Brick <b>Q<sup>b)</sup></b>	$f_b \geq 8 \text{ N/mm}^2$	$F_{Rd}$	[kN]	-	-	0,8	-	-
	$f_b \geq 10 \text{ N/mm}^2$	$F_{Rd}$	[kN]	-	-	1,0	-	-
	$f_b \geq 12 \text{ N/mm}^2$	$F_{Rd}$	[kN]	-	-	1,2	-	-
Vertic. perforated clay brick KSL R 1,6-16DF Brick <b>R<sup>b)</sup></b>	$f_b \geq 8 \text{ N/mm}^2$	$F_{Rd}$	[kN]	-	0,36	0,48	-	-
	$f_b \geq 10 \text{ N/mm}^2$	$F_{Rd}$	[kN]	-	0,48	0,6	-	-
	$f_b \geq 12 \text{ N/mm}^2$	$F_{Rd}$	[kN]	-	0,6	0,8	-	-
	$f_b \geq 16 \text{ N/mm}^2$	$F_{Rd}$	[kN]	-	0,8	1,0	-	-
Lightweight hollow brick Hbl B 2/0,8 Brick <b>S<sup>b)</sup></b>	$f_b \geq 2 \text{ N/mm}^2$	$F_{Rd}$	[kN]	0,12	-	-	-	-
Lightweight concrete hollow block Hbl 1,2-12DF Brick <b>T<sup>b)</sup></b>	$f_b \geq 2 \text{ N/mm}^2$	$F_{Rd}$	[kN]	-	0,2	0,3	-	-
	$f_b \geq 6 \text{ N/mm}^2$	$F_{Rd}$	[kN]	-	0,48	0,8	-	-
Ital. hollow brick Poroton P700 Brick <b>N<sup>b)</sup></b>	$f_b \geq 15 \text{ N/mm}^2$	$F_{Rd}$	[kN]	0,6	- <sup>c)</sup>	0,24	-	-
Ital. hollow brick Doppio Uni Brick <b>C+I<sup>b)</sup></b>	$f_b \geq 25 \text{ N/mm}^2$	$F_{Rd}$	[kN]	0,36 (C)	- <sup>c)</sup> (I)	0,6 (I)	-	-
Span. hollow brick Rojo hidrofugano Brick <b>D<sup>b)</sup></b>	$f_b \geq 40 \text{ N/mm}^2$	$F_{Rd}$	[kN]	0,24	-	-	-	-
Span. hollow brick Ladrillo perforado Brick <b>J<sup>b)</sup></b>	$f_b \geq 26 \text{ N/mm}^2$	$F_{Rd}$	[kN]	-	0,6	0,8	-	-
Span. hollow brick Clinker mediterraneo Brick <b>K<sup>b)</sup></b>	$f_b \geq 75 \text{ N/mm}^2$	$F_{Rd}$	[kN]	-	- <sup>c)</sup>	0,6	-	-
French hollow brick Brique Creuse <b>B<sup>b)</sup></b>	$f_b \geq 6 \text{ N/mm}^2$	$F_{Rd}$	[kN]	0,20	-	-	-	-

a) Valid for edge distance  $c \geq 150 \text{ mm}$ , intermediate values can be interpolated.

b) Specification on hollow base material brick types see separate table below.

c) Data can be determined by job-site testing, data for  $h_{nom}=50 \text{ mm}$  can be applied.

d) The influence of  $h_{nom} > 50 \text{ mm}$  (HRD 8) or  $h_{nom,1} > 50 \text{ mm}$  or  $h_{nom,2} > 70 \text{ mm}$  (HRD 10) has to be checked by job-site testing

**Recommended <sup>e)</sup> loads for masonry (Part 1)**

Anchor size			HRD 8	HRD 10		
			50 <sup>d)</sup>	50 <sup>d)</sup>	70 <sup>d)</sup>	90
$h_{nom}$ [mm]						
Solid clay brick Mz 2,0 DIN V 105-100/EN 771-1	$f_b \geq 20 \text{ N/mm}^2$	$F_{Rec}$ [kN]	0,42	0,85	c)	-
				1,28 <sup>a)</sup>		
	$f_b \geq 10 \text{ N/mm}^2$	$F_{Rec}$ [kN]	0,34	0,57	c)	
				0,85 <sup>a)</sup>		
Solid sand-lime brick KS 2,0 DIN V 106 /EN 771-2	$f_b \geq 20 \text{ N/mm}^2$	$F_{Rec}$ [kN]	0,7	0,85	c)	-
				1,28 <sup>a)</sup>		
	$f_b \geq 10 \text{ N/mm}^2$	$F_{Rec}$ [kN]	0,57	0,57	c)	-
				0,85 <sup>a)</sup>		
Lightweight solid block Vbl 0,9 DIN V 18151-100/EN 771	$f_b \geq 20 \text{ N/mm}^2$	$F_{Rec}$ [kN]	-	1,0	c)	-
				1,71 <sup>a)</sup>		
		$f_b \geq 10 \text{ N/mm}^2$	$F_{Rec}$ [kN]	-	0,71	c)
				1,28 <sup>a)</sup>		
	$f_b \geq 2 \text{ N/mm}^2$	$F_{Rec}$ [kN]	0,14	-	-	-
Ital. solid brick Tufo	$f_b \geq n/a$	$F_{Rd}$ [kN]	0,4	-	-	-
Hollow clay brick Hz B 12/1,2 Brick <b>A</b> <sup>b)</sup>	$f_b \geq 12 \text{ N/mm}^2$	$F_{Rd}$ [kN]	0,14	-	-	-
Vertic. perforated clay brick Hz 1,2-2DF Brick <b>F</b> <sup>b)</sup>	$f_b \geq 8 \text{ N/mm}^2$	$F_{Rd}$ [kN]	-	0,42	-	-
	$f_b \geq 10 \text{ N/mm}^2$	$F_{Rd}$ [kN]	-	0,57	-	-
	$f_b \geq 12 \text{ N/mm}^2$	$F_{Rd}$ [kN]	-	0,57	-	-
Vertic. perforated clay brick Hz 1,0-2DF Brick <b>G</b> <sup>b)</sup>	$f_b \geq 8 \text{ N/mm}^2$	$F_{Rd}$ [kN]	-	0,11	0,21	-
	$f_b \geq 10 \text{ N/mm}^2$	$F_{Rd}$ [kN]	-	0,14	0,25	-
	$f_b \geq 12 \text{ N/mm}^2$	$F_{Rd}$ [kN]	-	0,17	0,25	-
	$f_b \geq 20 \text{ N/mm}^2$	$F_{Rd}$ [kN]	-	0,25	0,42	-
Vertic. perforated clay brick Hz 1,0-2DF Brick <b>H</b> <sup>b)</sup>	$f_b \geq 28 \text{ N/mm}^2$	$F_{Rd}$ [kN]	-	0,57	0,71	-
	$f_b \geq 50 \text{ N/mm}^2$	$F_{Rd}$ [kN]	-	0,85	1,0	-
Vertic. perforated clay brick Poroton T8 Brick <b>M</b> <sup>b)</sup>	$f_b \geq 6 \text{ N/mm}^2$	$F_{Rd}$ [kN]	-	0,21	0,42	-
Vertic. perforated clay brick Hz 1,0-9DF Brick <b>L</b> <sup>b)</sup>	$f_b \geq 8 \text{ N/mm}^2$	$F_{Rd}$ [kN]	-	0,34	0,42	-
	$f_b \geq 10 \text{ N/mm}^2$	$F_{Rd}$ [kN]	-	0,42	0,42	-
	$f_b \geq 12 \text{ N/mm}^2$	$F_{Rd}$ [kN]	-	0,42	0,57	-
	$f_b \geq 16 \text{ N/mm}^2$	$F_{Rd}$ [kN]	-	0,57	0,71	-

a) Valid for edge distance  $c \geq 150 \text{ mm}$ , intermediate values can be interpolated.

b) Specification on hollow base material brick types see separate table below.

c) Data can be determined by job-site testing, data for  $h_{nom}=50 \text{ mm}$  can be applied.

d) The influence of  $h_{nom} > 50 \text{ mm}$  (HRD 8) or  $h_{nom,1} > 50 \text{ mm}$  or  $h_{nom,2} > 70 \text{ mm}$  (HRD 10) has to be checked by job-site testing

e) With overall partial safety factor for action  $\gamma = 1,4$ . The partial safety factors for action depend on the type of loading and shall be taken from national regulations.

**Recommended <sup>e)</sup> loads for masonry (Part 1)**

Anchor size			HRD 8	HRD 10		
			50 <sup>d)</sup>	50 <sup>d)</sup>	70 <sup>d)</sup>	90
$h_{nom}$ [mm]						
Hollow sand-lime brick KSL 12/1,4 Brick <b>O<sup>b)</sup></b>	$f_b \geq 12 \text{ N/mm}^2$	$F_{Rec}$ [kN]	0,21	-	-	-
Vertic. perforated clay brick Hz 1,6-2DF Brick <b>P<sup>b)</sup></b>	$f_b \geq 8 \text{ N/mm}^2$	$F_{Rec}$ [kN]	-	0,42	-	-
	$f_b \geq 10 \text{ N/mm}^2$	$F_{Rec}$ [kN]	-	0,42	-	-
	$f_b \geq 12 \text{ N/mm}^2$	$F_{Rec}$ [kN]	-	0,57	-	-
Vertic. perforated clay brick Hz 1,6-2DF Brick <b>Q<sup>b)</sup></b>	$f_b \geq 8 \text{ N/mm}^2$	$F_{Rec}$ [kN]	-	-	0,57	-
	$f_b \geq 10 \text{ N/mm}^2$	$F_{Rec}$ [kN]	-	-	0,71	-
	$f_b \geq 12 \text{ N/mm}^2$	$F_{Rec}$ [kN]	-	-	0,85	-
Vertic. perforated clay brick KSL R 1,6-16DF Brick <b>R<sup>b)</sup></b>	$f_b \geq 8 \text{ N/mm}^2$	$F_{Rec}$ [kN]	-	0,25	0,34	-
	$f_b \geq 10 \text{ N/mm}^2$	$F_{Rec}$ [kN]	-	0,34	0,42	-
	$f_b \geq 12 \text{ N/mm}^2$	$F_{Rec}$ [kN]	-	0,42	0,57	-
	$f_b \geq 16 \text{ N/mm}^2$	$F_{Rec}$ [kN]	-	0,57	0,71	-
Lightweight hollow brick Hbl B 2/0,8 Brick <b>S<sup>b)</sup></b>	$f_b \geq 2 \text{ N/mm}^2$	$F_{Rec}$ [kN]	0,09	-	-	-
Lightweight concrete hollow block Hbl 1,2-12DF Brick <b>T<sup>b)</sup></b>	$f_b \geq 2 \text{ N/mm}^2$	$F_{Rec}$ [kN]	-	0,14	0,21	-
	$f_b \geq 6 \text{ N/mm}^2$	$F_{Rec}$ [kN]	-	0,34	0,57	-
Ital. hollow brick Poroton P700 Brick <b>N<sup>b)</sup></b>	$f_b \geq 15 \text{ N/mm}^2$	$F_{Rec}$ [kN]	0,43	- <sup>c)</sup>	0,17	-
Ital. hollow brick Doppio Uni Brick <b>C+I<sup>b)</sup></b>	$f_b \geq 25 \text{ N/mm}^2$	$F_{Rec}$ [kN]	0,25 (C)	- <sup>c)</sup>	0,42 (I)	-
Span. hollow brick Rojo hidrofugano Brick <b>D<sup>b)</sup></b>	$f_b \geq 40 \text{ N/mm}^2$	$F_{Rec}$ [kN]	0,17	-	-	-
Span. hollow brick Ladrillo perforado Brick <b>J<sup>b)</sup></b>	$f_b \geq 26 \text{ N/mm}^2$	$F_{Rec}$ [kN]	-	0,42	0,57	-
Span. hollow brick Clinker mediterraneo Brick <b>K<sup>b)</sup></b>	$f_b \geq 75 \text{ N/mm}^2$	$F_{Rec}$ [kN]	-	- <sup>c)</sup>	0,42	-
French hollow brick Brique Creuse <b>B<sup>b)</sup></b>	$f_b \geq 6 \text{ N/mm}^2$	$F_{Rec}$ [kN]	0,14	-	-	-

a) Valid for edge distance  $c \geq 150\text{mm}$ , intermediate values can be interpolated.

b) Specification on hollow base material brick types see separate table below.

c) Data can be determined by job-site testing, data for  $h_{nom}=50\text{mm}$  can be applied.

d) The influence of  $h_{nom} > 50 \text{ mm}$  (HRD 8) or  $h_{nom,1} > 50 \text{ mm}$  or  $h_{nom,2} > 70 \text{ mm}$  (HRD 10) has to be checked by job-site testing

e) With overall partial safety factor for action  $\gamma = 1,4$ . The partial safety factors for action depend on the type of loading and shall be taken from national regulations.

**Characteristic resistance for AAC <sup>a)</sup> (Part 2)**

Anchor size			HRD 8		HRD 10	
$h_{nom}$ [mm]			50	50	70	90
Autoclaved aerated concrete AAC	AAC 2	$F_{Rk}$ [kN]	-	-	0,9	0,9
	AAC 4	$F_{Rk}$ [kN]	0,42	-	2,0	2,0
			0,42	-	2,0 <sup>b)</sup>	2,5 <sup>b)</sup>
	AAC 6	$F_{Rk}$ [kN]	0,42	-	2,0	2,5
0,42			-	3,5 <sup>b)</sup>	4,5 <sup>b)</sup>	

a) Drilling method: rotary drilling only

 b) Valid for edge distance  $c \geq 150$ mm, intermediate values can be interpolated

**Characteristic resistance for AAC <sup>a)</sup> (Part 2)**

Anchor size			HRD 8		HRD 10	
$h_{nom}$ [mm]			50	50	70	90
Autoclaved aerated concrete AAC	AAC 2	$F_{Rd}$ [kN]	-	-	0,45	0,45
	AAC 4	$F_{Rd}$ [kN]	0,21	-	1,0	1,0
			0,21	-	1,0 <sup>b)</sup>	1,25 <sup>b)</sup>
	AAC 6	$F_{Rd}$ [kN]	0,21	-	1,0	1,25
0,21			-	1,75 <sup>b)</sup>	2,25 <sup>b)</sup>	

a) Drilling method: rotary drilling only

 b) Valid for edge distance  $c \geq 150$ mm, intermediate values can be interpolated

**Recommended <sup>c)</sup> loads for AAC <sup>a)</sup> (Part 2)**

Anchor size			HRD 8		HRD 10	
$h_{nom}$ [mm]			50	50	70	90
Autoclaved aerated concrete AAC	AAC 2	$F_{Rec}$ [kN]	-	-	0,32	0,32
	AAC 4	$F_{Rec}$ [kN]	0,15	-	0,71	0,71
			0,15	-	0,71 <sup>b)</sup>	0,89 <sup>b)</sup>
	AAC 6	$F_{Rec}$ [kN]	0,15	-	0,71	0,89
0,15			-	1,25 <sup>b)</sup>	1,6 <sup>b)</sup>	

a) Drilling method: rotary drilling only

 b) Valid for edge distance  $c \geq 150$ mm, intermediate values can be interpolated

 c) With overall partial safety factor for action  $\gamma = 1,4$ . The partial safety factors for action depend on the type of loading and shall be taken from national regulations.

**Requirements for redundant fastening**

The definition of redundant fastening according to Member States is given in ETAG 020. In Absence of a definition by a Member State the following default values may be taken.		
Maximum number of fixing points	Minimum number of anchors per fixing point	Maximum design load of action $N_{Sd}$ per fixing point <sup>a)</sup>
3	1	3 [kN]
4	1	4,5 [kN]



**Basic loading data for redundant fastening in prestressed hollow core slabs**
**All data in this section applies to:**

- Correct anchor setting (See setting instruction)
- No edge distance and spacing influence
- Concrete  $\geq$  C35/45
- Data is according to ETA-07/0219

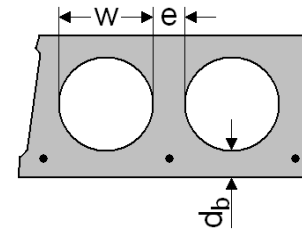
**Characteristic resistance**

Anchor size			HRD 10			
Bottom flange thickness	$d_b$	[mm]	$\geq 25$	$\geq 30$	$\geq 35$	$\geq 40$
Resistance, all load directions	$N_{Rk}$	[kN]	0,6	1,5	2,5	3,5

a) The anchor may be used in a flange thickness of 30 mm with the same resistance but the drill hole is not allowed to cut cavity

**Design resistance**

Anchor size			HRD 10			
Bottom flange thickness	$d_b$	[mm]	$\geq 25$	$\geq 30$	$\geq 35$	$\geq 40$
Resistance, all load directions	$N_{Rd}$	[kN]	0,3	0,8	1,4	1,9

a) The anchor may be used in a flange thickness of 30 mm with the same resistance but the drill hole is not allowed to cut cavity

**Recommended loads <sup>a)</sup>**

Anchor size			HRD 10			
Bottom flange thickness	$d_b$	[mm]	$\geq 25$	$\geq 30$	$\geq 35$	$\geq 40$
Resistance, all load directions	$N_{Rec}$	[kN]	0,2	0,6	1,0	1,4

a) With overall partial safety factor for action  $\gamma = 1,4$ . The partial safety factors for action depend on the type of loading and shall be taken from national regulations.

**Requirements for redundant fastening**

The definition of redundant fastening according to Member States is given in ETAG 020. In Absence of a definition by a Member State the following default values may be taken.

Maximum number of fixing points	Minimum number of anchors per fixing point	Maximum design load of action $N_{Sd}$ per fixing point <sup>a)</sup>
3	1	3 [kN]
4	1	4,5 [kN]

**Specification of hollow base material brick types**

Specification	Picture	Drilling method	Specification	Picture	Drilling method
Brick <b>A</b> Hlz B 12/1,2 LxWxH [mm]: 300x240x248 h <sub>min</sub> [mm]: 240		Rotary drilling	Brick <b>B</b> Brique Creuse LxWxH [mm] : 210x198x... h <sub>min</sub> [mm]: 210		Rotary drilling
Brick <b>C</b> Doppio Uni LxWxH [mm]: 230x120x100 h <sub>min</sub> [mm]: 120		Rotary drilling	Brick <b>D</b> Rojo hidrofugano LxWxH [mm]: 240x115x50 h <sub>min</sub> [mm]: 115		Rotary drilling
brick <b>E</b> Mattone LxWxH [mm]: 240x180x100 h <sub>min</sub> [mm]: 180		Rotary drilling	brick <b>F</b> Hlz 1,2-2DF LxWxH [mm]: 240x115x113 h <sub>min</sub> [mm]: 115		Hammer drilling
brick <b>G</b> Hlz 1,0-2DF LxWxH [mm]: 240x115x113 h <sub>min</sub> [mm]: 110		Hammer drilling	brick <b>H</b> VHlz 1,6-2DF LxWxH [mm]: 240x115x113 h <sub>min</sub> [mm]: 115		Hammer drilling
brick <b>I</b> Doppio Uni LxWxH [mm]: 250x120x190 h <sub>min</sub> [mm]: 120		Rotary drilling	brick <b>J</b> Ladrillo perforado LxWxH [mm]: 240x110x100 h <sub>min</sub> [mm]: 110		Rotary drilling
brick <b>K</b> Clinker mediterr. LxWxH [mm]: 240x113x50 h <sub>min</sub> [mm]: 113		Hammer drilling	brick <b>L</b> Hlz 1,0-9DF LxWxH [mm]: 372x175x238 h <sub>min</sub> [mm]: 175		Rotary drilling
brick <b>M</b> Poroton T8 LxWxH [mm]: 248x365x249 h <sub>min</sub> [mm]: 365		Rotary drilling	brick <b>N</b> Poroton P700 LxWxH [mm]: 225x300x190 h <sub>min</sub> [mm]: 300		Rotary drilling
<b>Hollow sand-lime bricks according EN 771-2</b>					
brick <b>O</b> KSL 12/1,4 LxWxH [mm]: 240x248x248 h <sub>min</sub> [mm]: 240		Hammer drilling	brick <b>P</b> KS L 1,6-2DF LxWxH [mm]: 240x115x113 h <sub>min</sub> [mm]: 115		Hammer drilling
brick <b>Q</b> KS L 1,4-3DF LxWxH [mm]: 240x175x113 h <sub>min</sub> [mm]: 175		Hammer drilling	brick <b>R</b> KS L R 1,6-16DF LxWxH [mm]: 480x240x248 h <sub>min</sub> [mm]: 240		Rotary drilling
brick <b>S</b> Hbl 2/0,8 LxWxH [mm]: 497x240x248 h <sub>min</sub> [mm]: 240		Hammer drilling	brick <b>T</b> Hbl 1,2-12DF LxWxH [mm]: 497x175x238 h <sub>min</sub> [mm]: 175		Rotary drilling

**Materials**
**Mechanical properties**

Anchor size			HRD 8		HRD 10		
			Galvanized steel	Stainless steel	Galvanized steel	Hot-deep galvanized	Stainless steel
Nominal tensile strength	$f_{uk}$	[N/mm <sup>2</sup> ]	600	580	600	600	630
Yield strength	$f_{yk}$	[N/mm <sup>2</sup> ]	480	450	480	480	480
Stressed cross-section	$A_s$	[mm <sup>2</sup> ]	22,9	22,9	35,3	33,7	35,3
Moment of resistance	$W$	[mm <sup>3</sup> ]	15,5	15,5	29,5	27,6	29,5
Characteristic bending resistance	$M^0_{Rk,s}$	[Nm]	11,1	10,8	21,3	19,9	22,3

**Material quality**

Part	Material	
Sleeve	Polyamide, color red	
Screw <sup>a)</sup>	HRD-C, -H, -K, -P HDS-C, -H, -K, -P	Carbon steel, galvanized to min.5 $\mu$ m
	HRD-HF; HDS-HF	Carbon steel, hot-dip galvanized to min. 65 $\mu$ m
	HRD-CR2, -HR2, -KR2, -PR2 HDS-CR2, -HR2, -KR2, -PR2	Stainless steel, corrosion class II: 1.4301 / 1.4567
	HRD-CR, -HR, -KR, -PR HDS-CR, -HR, -KR, -PR	Stainless steel, corrosion class III: 1.4362/1.4401/1.4404/1.4571

a) Marking of the screw (HDR and HDS) depending on the supply.

**Anchor dimension**

Anchor size			HRD 8	HRD 10
Minimum thickness of fixture	$t_{fix,min}$	[mm]	0	0
Maximum thickness of fixture	$t_{fix,max}$	[mm]	90	260
Diameter of the sleeve	$d_{nom}$	[mm]	8	10
Minimum length of the sleeve	$l_{1,min}$	[mm]	60	60
Maximum length of the sleeve	$l_{1,max}$	[mm]	140	310
Diameter of plastic washer	$d_{pw}$	[mm]	-	17,5
Thickness of plastic washer	$t_{pw}$	[mm]	-	2
Diameter of the screw	$d_s$	[mm]	6	7
Minimum length of the screw	$l_{2,min}$	[mm]	65	65
Maximum length of the screw	$l_{2,max}$	[mm]	145	315
Head diameter of countersunk screw	$d_{sc}$	[mm]	11	14
Head diameter of hexhead screw	$d_{sw}$	[mm]	-	17,5

### Anchor sleeve

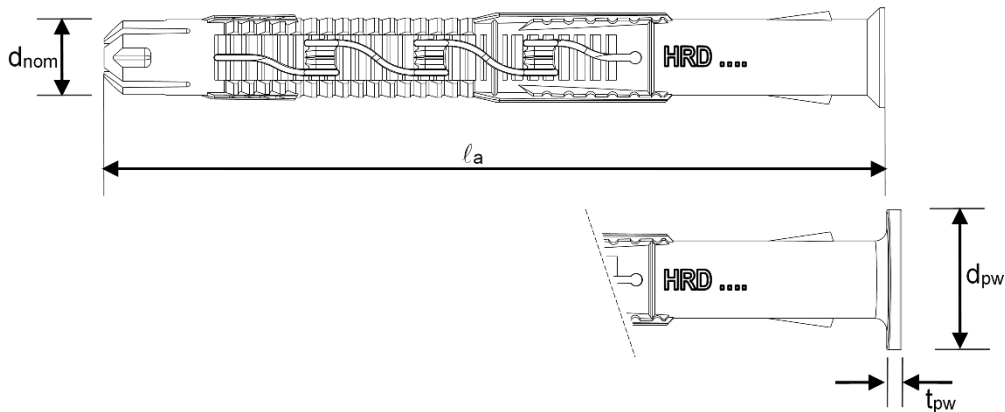

### Special screw

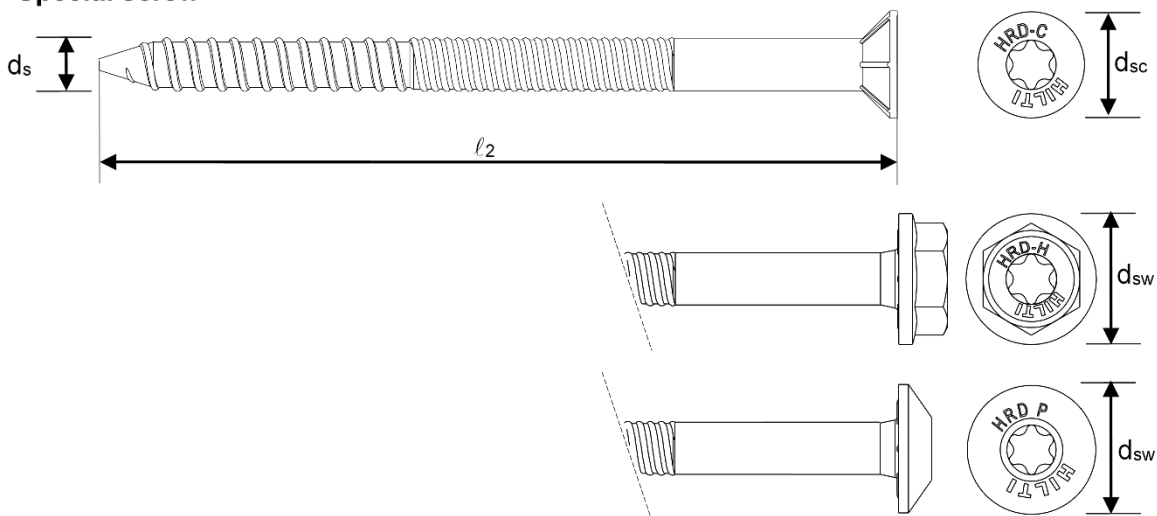

### Setting information

#### Installation temperature

-10°C to +40°C

#### Service temperature range

Hilti HRD frame anchors may be applied in the temperature range given below.

Temperature range	Base material temperature	Max. long term base material temperature	Max. short term base material temperature
Temperature range	-40 °C to +80 °C	+50 °C	+80 °C

#### Max short term base material temperature

Short-term elevated base material temperatures are those that occur over brief intervals, e.g. as a result of diurnal cycling.

#### Max long term base material temperature

Long-term elevated base material temperatures are roughly constant over significant periods of time.

**Setting details**

Anchor size			HRD 8	HRD 10
Drill hole diameter	$d_o$	[mm]	8	10
Cutting diameter of drill bit	$d_{cut} \leq$	[mm]	8,45	10,45
Depth of drilled hole to deepest point	$h_{1,1} \geq$	[mm]	60	60
	$h_{1,2} \geq$	[mm]	-	80
	$h_{1,3} \geq$	[mm]	-	100 <sup>a)</sup>
Overall plastic anchor embedment depth in base material	$h_{nom,1} \geq$	[mm]	50	50
	$h_{nom,2} \geq$	[mm]	-	70
	$h_{nom,3} \geq$	[mm]	-	90 <sup>a)</sup>
Diameter of clearance hole in the fixture	Countersunk screw	$d_f \leq$	[mm]	8,5
	Hexhead screw	$d_f \leq$	[mm]	-
				12

a) For use in AAC

**Setting parameters**

Anchor size			HRD 8	HRD 10	
	$h_{nom}$	[mm]	50	50	70
Minimum base material thickness	Concrete	$h_{min}$	[mm]	100	120
	Concrete thin skin	$h_{min}$	[mm]	-	40
	Masonry <sup>e)</sup>	$h_{min}$	[mm]	115-300	
Minimum spacing	Concrete $\geq$ C16/20	$s_{min}$	[mm]	100	50
		for $c \geq$	[mm]	50	100 <sup>c)</sup>
	Concrete C12/15	$s_{min}$	[mm]	140	70
		for $c \geq$	[mm]	70	140 <sup>c)</sup>
	Masonry and AAC	$a_{min}$	[mm]	250	250
		$s_{min1}$	[mm]	200 (120 <sup>d)</sup> )	100
$s_{min2}$		[mm]	400 (240 <sup>d)</sup> )	100	
Minimum edge distance	Concrete $\geq$ C16/20	$c_{min}$	[mm]	50	50
		for $s \geq$	[mm]	100	150 <sup>c)</sup>
	Concrete C12/15	$c_{min}$	[mm]	70	70
		for $s \geq$	[mm]	140	210 <sup>c)</sup>
Masonry and AAC	$c_{min}$	[mm]	100 (60 <sup>d)</sup> )	100	
Critical spacing in concrete <sup>a)</sup>	Concrete $\geq$ C16/20	$s_{cr,N}$	[mm]	62	80
	Concrete C12/15	$s_{cr,N}$	[mm]	68	90
Critical edge distance in concrete <sup>b)</sup>	Concrete $\geq$ C16/20	$c_{cr,N}$	[mm]	100	100
	Concrete C12/15	$c_{cr,N}$	[mm]	140	140

a) For spacing larger than the critical spacing each anchor in a group can be considered in design

b) For edge distance smaller than critical edge distance the design loads

c) Linear interpolation allowed

d) Only for brick "Doppio Uni" and "Mattoni"

e) Minimum base material thickness of masonry depends on brick type; see specification of brick types in the table above

For spacing (edge distance) smaller than critical spacing (critical edge distance) the design loads have to be reduced.

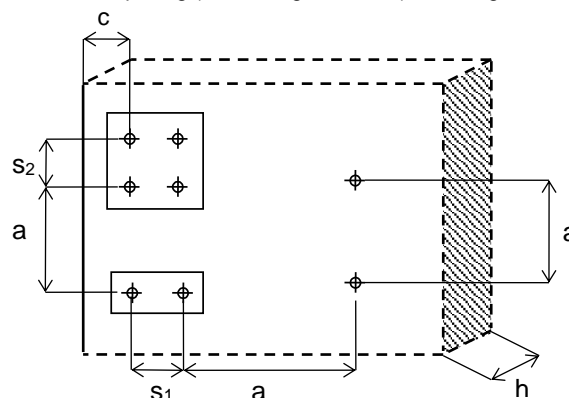

**Installation equipment**

Anchor size	HRD 8	HRD 10
Rotary hammer	TE 2- TE16	
Other tools	Hammer, Screwdriver	

**Admissible anchor positions, min. spacing and edge distance of anchors and distance between anchor groups in precast pre-stressed hollow core slabs**

Anchor size		HRD 8	HRD 10
Overall plastic anchor embedment depth in the base material	$h_{nom} \geq$ [mm]	-	50
Bottom flange thickness	$d_b \geq$ [mm]	-	25
Core distance	$l_c \geq$ [mm]	-	100
Prestressing steel distance	$l_p \geq$ [mm]	-	100
Distance between anchor position and prestressing steel	$a_p \geq$ [mm]	-	50
Minimum edge distance	$c_{min} \geq$ [mm]	-	100
Minimum anchor spacing	$s_{min} \geq$ [mm]	-	100
Minimum distance between anchor groups	$a_{min} \geq$ [mm]	-	100

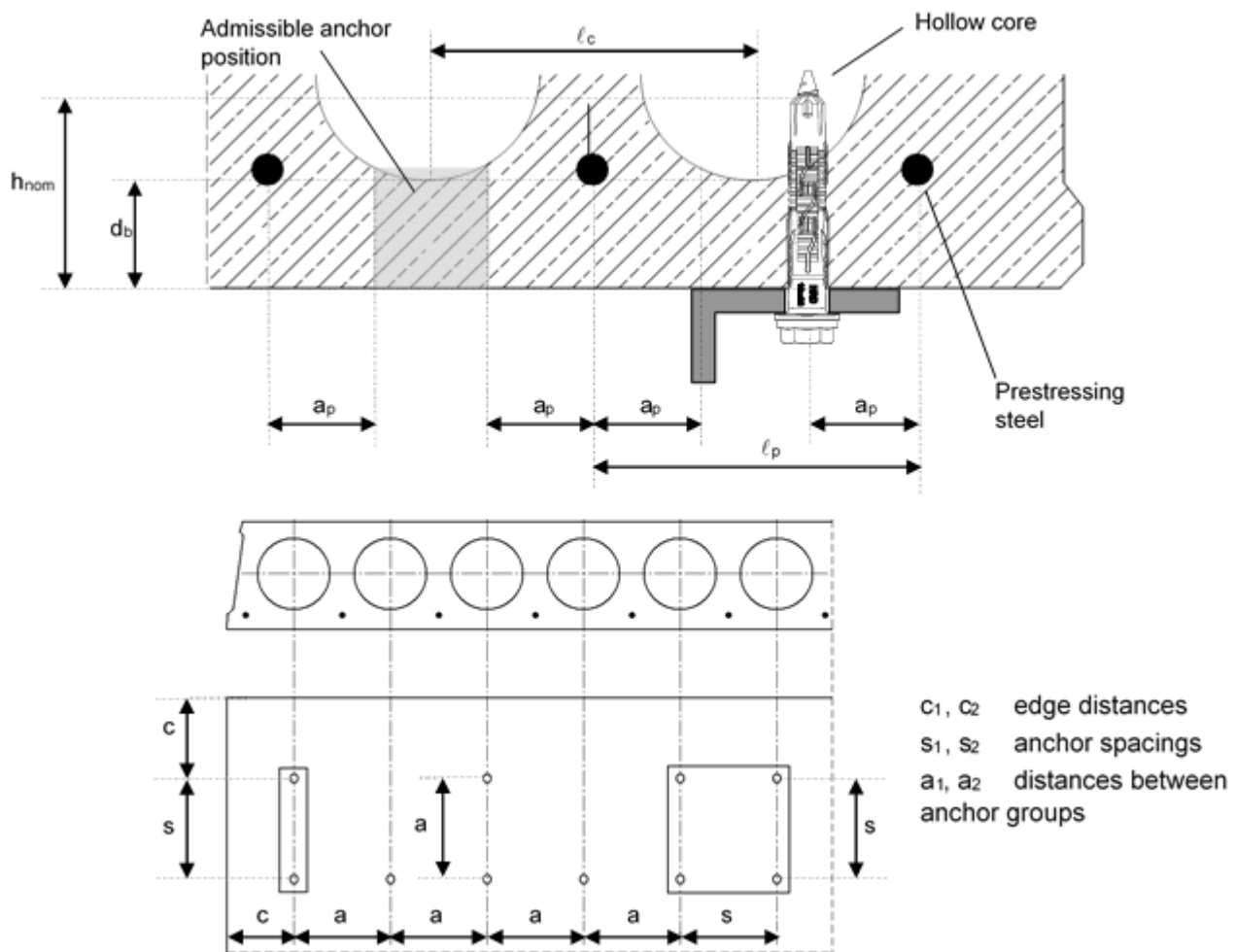
**Schemes of distances and spacing**

**Setting instruction**

\*For detailed information on installation see instruction for use given with the package of the product.

Setting instruction for HRD	
<p><b>1. Drilling</b></p>	<p><b>2. Inserting the anchor</b></p>
<p><b>3. Inserting the anchor</b></p>	<p><b>4. Setting tools</b></p>
<p><b>5. Checking</b></p>	<p><b>6. Attaching the belonging washer</b></p>
<p><b>7. Attaching the belonging washer</b></p>	
Additional preparation in case of application in precast prestressed hollow core slabs	
<p><b>1. Location of pre-stressed bars</b></p>	<p><b>2. Marking location of pre-stressed bars</b></p>
<p><b>3. Marking location of pre-stressed bars</b></p>	<p><b>4. Drilling</b></p>

### 3.5.3 HRV

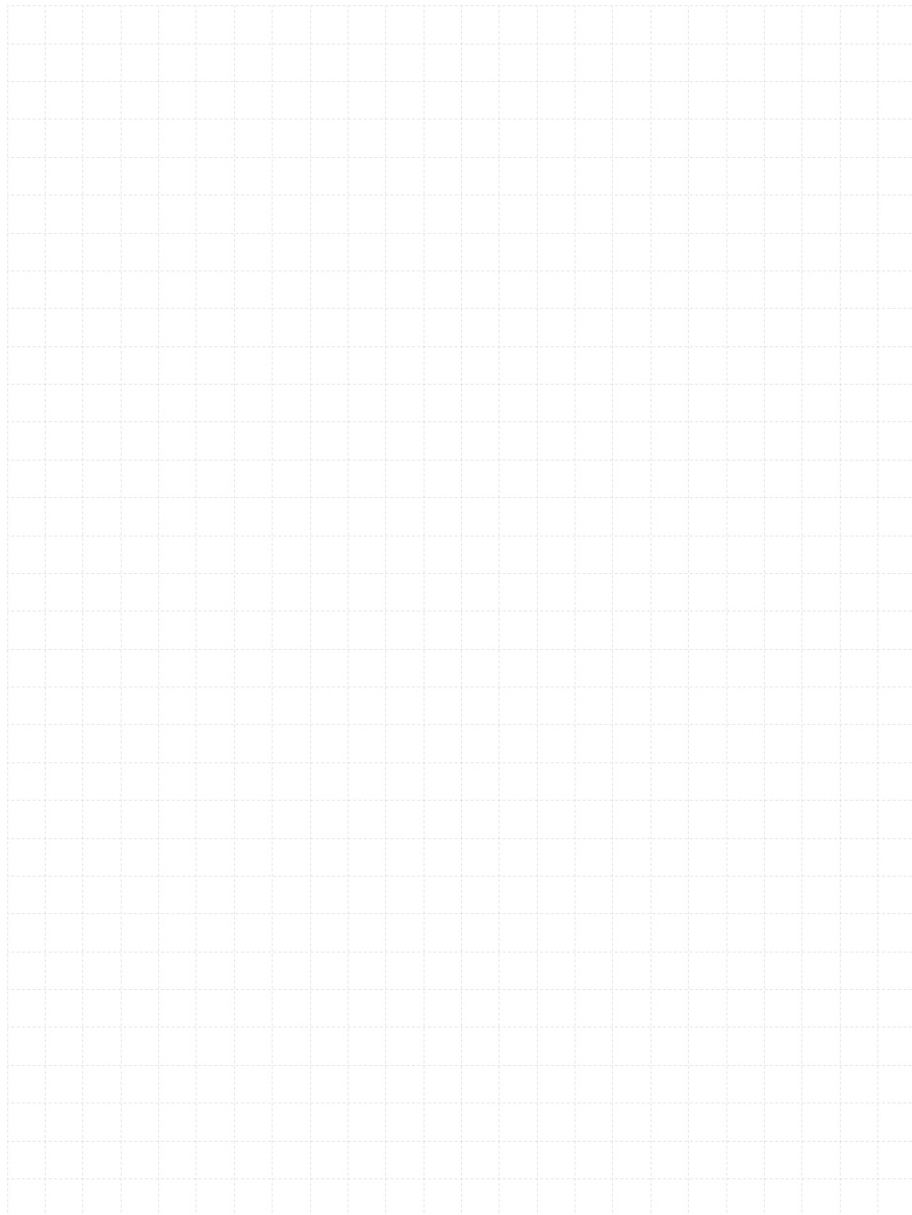



# HRV Plastic anchors

## Economical plastic frame anchor

### Anchor version



HRV-H  
HRV-HF  
(d10)

### Benefits

- Available in carbon steel and hot-deep galvanized
- Suitable for concrete and steel washers
- Integrated plastic and steel washer

### Base material



Concrete  
(non-cracked)

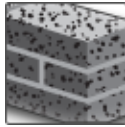

Solid brick

### Basic loading data

#### All data in this section applies to:

- Correct setting (See setting instruction)
- No edge distance and spacing influence
- Non-cracked concrete C16/20 – C50/60, other base material as specified
- Minimum base material thickness
- **Steel failure**
- Shear without lever arm
- Anchor for single point application

#### Anchorage depth

Anchor size	HRV 10	
Overall plastic anchor embedment depth in base material	$h_{nom}$	[mm]
		70

#### Characteristic resistance

Anchor size	HRV 10	
Concrete C16/20 – C50/60	$N_{Rk}$	[kN]
	$V_{Rk}$	[kN]
Solid clay brick	$f_b \geq 10 \text{ n/mm}^2$	$F_{Rk}$ [kN]
	$f_b \geq 20 \text{ n/mm}^2$	$F_{Rk}$ [kN]
Russian solid clay brick	$f_b \geq 10 \text{ n/mm}^2$	$F_{Rk}$ [kN]
	$f_b \geq 20 \text{ n/mm}^2$	$F_{Rk}$ [kN]

#### Design resistance

Anchor size	HRV 10	
Concrete C16/20 – C50/60	$N_{Rd}$	[kN]
	$V_{Rd}$	[kN]
Solid clay brick	$f_b \geq 10 \text{ n/mm}^2$	$F_{Rd}$ [kN]
	$f_b \geq 20 \text{ n/mm}^2$	$F_{Rd}$ [kN]
Russian solid clay brick	$f_b \geq 10 \text{ n/mm}^2$	$F_{Rd}$ [kN]
	$f_b \geq 20 \text{ n/mm}^2$	$F_{Rd}$ [kN]

**Recommended loads<sup>a)</sup>**

Anchor size			HRV 10
Concrete C16/20 – C50/60		$N_{Rd}$ [kN]	2,4
		$V_{Rd}$ [kN]	4,8
Solid clay brick	$f_b \geq 10 \text{ n/mm}^2$	$F_{Rd}$ [kN]	0,57
	$f_b \geq 20 \text{ n/mm}^2$	$F_{Rd}$ [kN]	0,86
Russian solid clay brick	$f_b \geq 10 \text{ n/mm}^2$	$F_{Rd}$ [kN]	0,57
	$f_b \geq 20 \text{ n/mm}^2$	$F_{Rd}$ [kN]	0,86

a) With overall partial safety factor for action  $\gamma = 1,4$ . The partial safety factors for action depend on the type of loading and shall be taken from national regulations.



**Materials**
**Mechanical properties**

Anchor size			HRV 10	
			Galvanized steel	Hot-dip galvanized
Nominal tensile strength	$f_{uk}$	[N/mm <sup>2</sup> ]	600	600
Yield strength	$f_{yk}$	[N/mm <sup>2</sup> ]	480	480
Stressed cross-section	tension	$A_s$	[mm <sup>2</sup> ]	27,3
	shear			28,3
Moment of resistance	$W$	[mm <sup>3</sup> ]	21,2	21,2
Characteristic bending resistance	$M^0_{Rk,s}$	[Nm]	15,3	15,3

**Material quality**

Part	Material
Sleeve	Polyamide, color black
Screw	HRV-H
	HRV-HF
	Carbon steel, galvanized to min.5 $\mu\text{m}$
	Carbon steel, hot-dip galvanized to min. 65 $\mu\text{m}$

**Masonry base materials**

Solid clay brick	Russian solid clay brick
Mz 1,8 DIN 105-100 / EN 771-1 LxWxH [mm]: 240x115x113 h <sub>min</sub> [mm]: 115 	Density [kg/dm <sup>3</sup> ]: 1,9 LxWxH [mm]: 250x120x65 h <sub>min</sub> [mm]: 120 

**Anchor dimension**

Anchor size		HRV 10
Minimum thickness of fixture	$t_{fix,min}$ [mm]	0
Maximum thickness of fixture	$t_{fix,max}$ [mm]	30
Diameter of the sleeve	$d_{nom}$ [mm]	10
Minimum length of the sleeve	$l_{1,min}$ [mm]	80
Maximum length of the sleeve	$l_{1,max}$ [mm]	100
Diameter of plastic washer	$d_{pw}$ [mm]	17,8
Thickness of plastic washer	$t_{pw}$ [mm]	2,5
Diameter of the screw	$d_s$ [mm]	7
Minimum length of the screw	$l_{2,min}$ [mm]	75
Maximum length of the screw	$l_{2,max}$ [mm]	105
Head diameter of hexhead screw	$d_{sw}$ [mm]	17,5

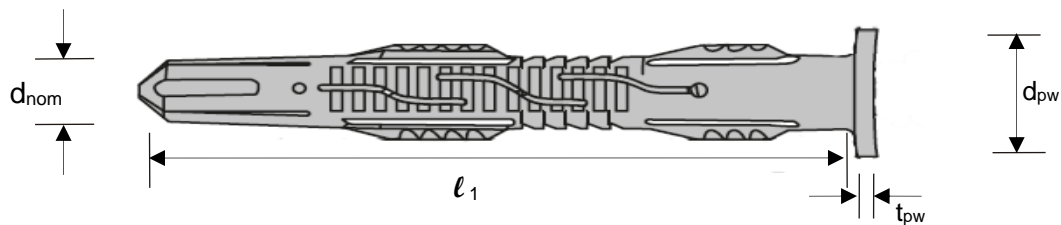
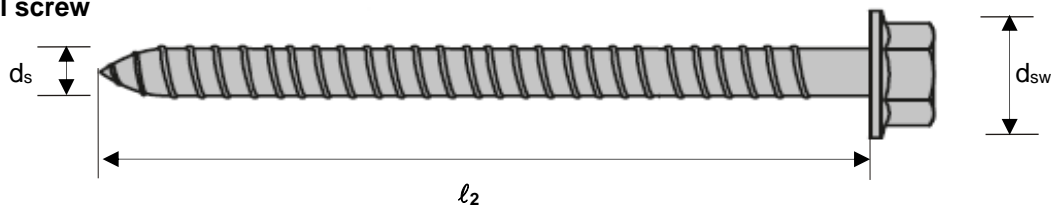
**Anchor sleeve**

**Special screw**

**Setting information**
**Installation temperature**

-10°C to +40°C

**Service temperature range**

Hilti HRV frame anchors may be applied in the temperature range given below.

Temperature range	Base material temperature	Max. long term base material temperature	Max. short term base material temperature
Temperature range	-40 °C to +80 °C	+50 °C	+80 °C

**Max short term base material temperature**

Short-term elevated base material temperatures are those that occur over brief intervals, e.g. as a result of diurnal cycling.

**Max long term base material temperature**

Long-term elevated base material temperatures are roughly constant over significant periods of time.

**Setting details**

Anchor size			HRV 10
Drill hole diameter	$d_o$	[mm]	10
Cutting diameter of drill bit	$d_{cut} \leq$	[mm]	10,45
Depth of drilled hole to deepest point	$h_1 \geq$	[mm]	80
Overall plastic anchor embedment depth in base material	$h_{nom} \geq$	[mm]	70
Diameter of clearance hole in the fixture	$d_f \leq$	[mm]	12

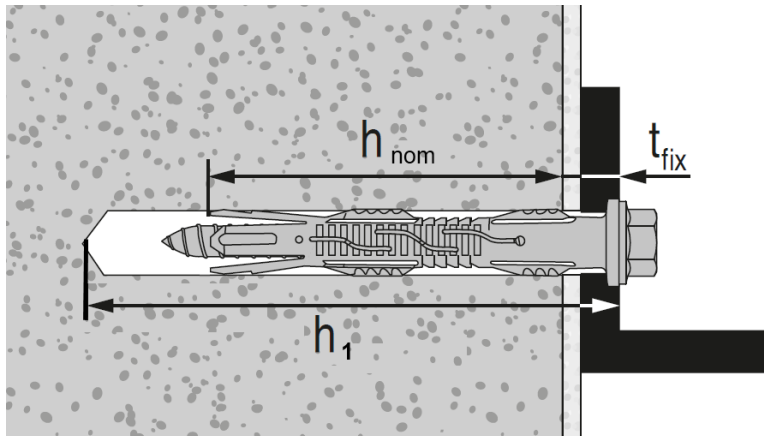

**Installation equipment**

Anchor size		HRV 10
Rotary hammer		TE 2- TE16
Other tools		Hammer, Screwdriver

**Setting parameters**

Anchor size			HRV 10
	$h_{nom}$	[mm]	<b>70</b>
Minimum base material thickness	$h_{min}$	[mm]	120
Minimum spacing	$s_{min}$	[mm]	50
	for $c \geq$	[mm]	100 <sup>a)</sup>
Minimum edge distance	$c_{min}$	[mm]	50
	for $c \geq$	[mm]	150 <sup>a)</sup>
Critical spacing for splitting failure	$s_{cr,sp}$	[mm]	200
Critical edge distance for splitting failure	$c_{cr,sp}$	[mm]	100
Critical spacing for concrete cone failure	$s_{cr,N}$	[mm]	210
Critical edge distance for concrete cone failure	$c_{cr,N}$	[mm]	105

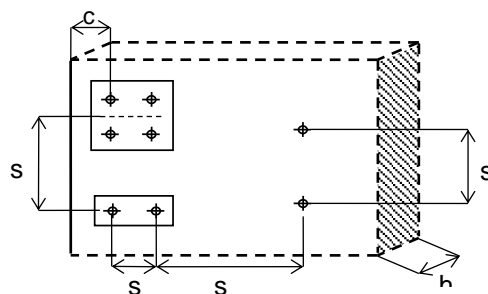
a) Linear interpolation allowed



## Setting instruction

\*For detailed information on installation see instruction for use given with the package of the product.

### Setting instruction for HRV

#### 1. Drilling

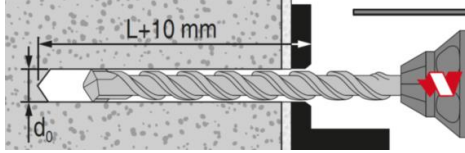

#### 2. Cleaning

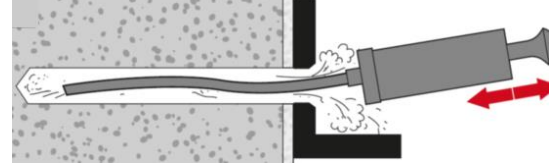

#### 3. Inserting the anchor with hand

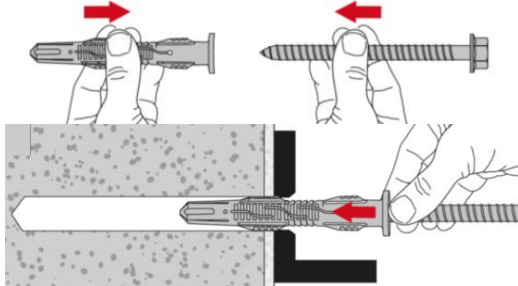

#### 4. Inserting the anchor with hammer

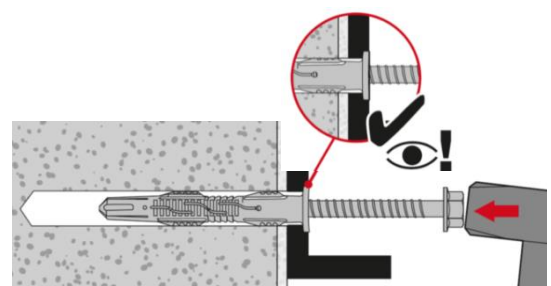

#### 5. Inserting the tools

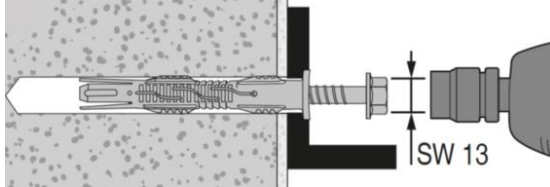

#### 6. Checking

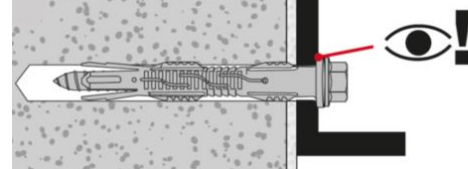

### 3.5.4 HPS-1

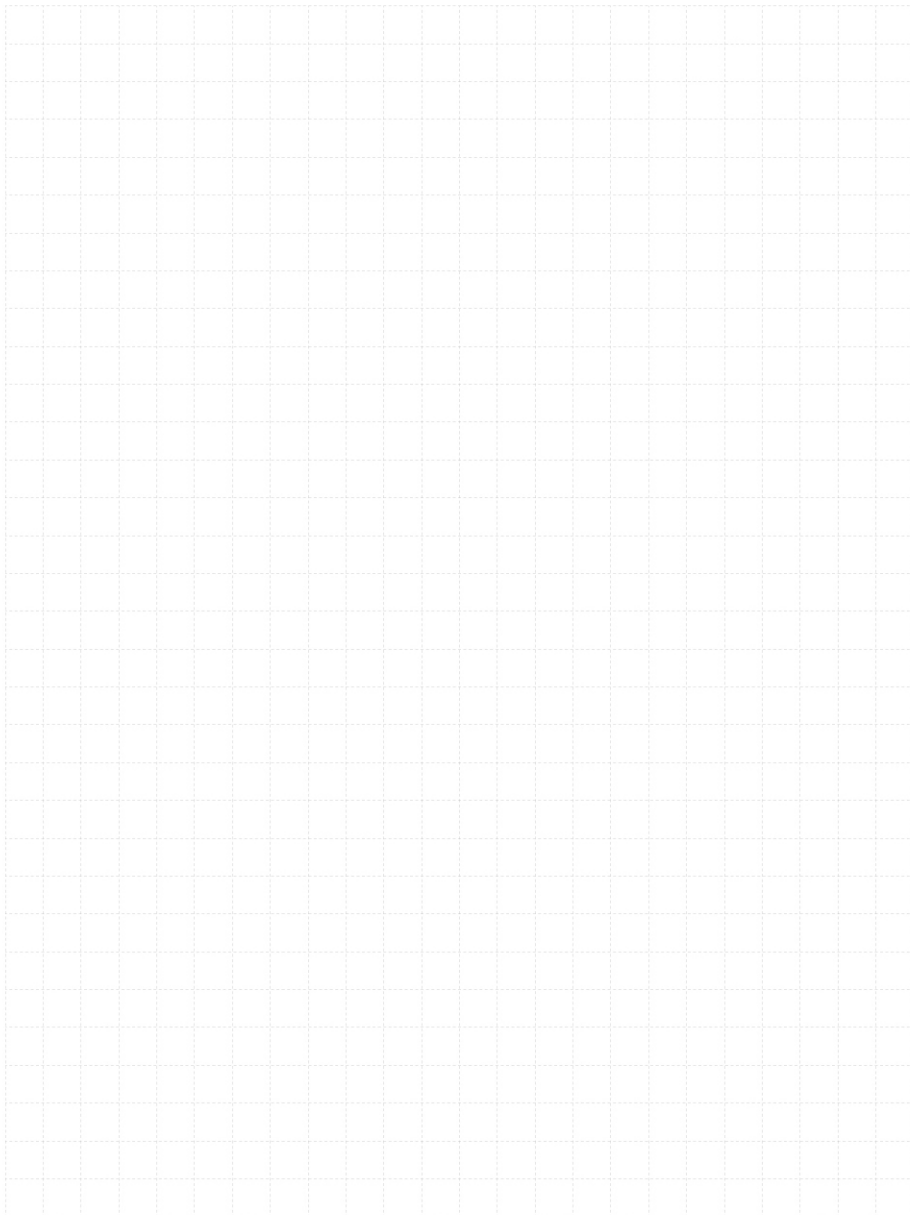

# HPS-1 Plastic anchors

## Economical plastic impact anchor

### Anchor version



HPS-1  
(d4-d8)

### Benefits

- Impact anchor for light frames, battens and profiles on solid base materials
- Impact and temperature resistant
- High quality plastic

### Base material



Concrete  
(non-cracked)

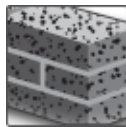

Solid brick

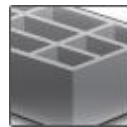

Hollow brick

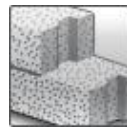

Autoclaved  
aerated  
concrete

### Basic loading data

#### All data in this section applies to:

- Correct setting (See setting instruction)
- No edge distance and spacing influence
- Base material as specified in the table
- Minimum base material thickness

### Anchorage depth

Anchor size		4/0	5/0	5/5- 5/15	6/0- 6/25	6/30- 6/40	8/0	8/10- 8/40	8/60- 8/100
Nominal embedment depth	$h_{nom}$ [mm]	25	30	30	40	40	50	50	50

### Recommended loads<sup>a)</sup>

Anchor size		4/0	5/0	5/5- 5/15	6/0- 6/25	6/30- 6/40	8/0	8/10- 8/40	8/60- 8/100
Concrete $\geq$ C16/20	$N_{Rec}$ [kN]	0,05	0,10	0,15	0,25	0,25	0,30	0,40	0,40
	$V_{Rec}$ [kN]	0,15	0,30	0,35	0,55	0,35	0,50	0,90	0,50
Engineering brick, 12 hole, class B	$N_{Rec}$ [kN]	0,05	0,10	0,15	0,25	0,25	0,30	0,40	0,40
	$V_{Rec}$ [kN]	0,15	0,30	0,35	0,55	0,35	0,50	0,90	0,50
Perforated brick 3 hole common	$N_{Rec}$ [kN]	0,05	0,10	0,15	0,20	0,20	0,25	0,30	0,30
	$V_{Rec}$ [kN]	0,15	0,30	0,35	0,55	0,35	0,50	0,90	0,55
Thermalite block, 7 N lightweights	$N_{Rec}$ [kN]	-	-	0,08	0,15	0,15	0,20	0,25	0,25
	$V_{Rec}$ [kN]	-	-	0,15	0,25	0,15	0,40	0,40	0,25
Thermalite block, 1/2 N lightweights	$N_{Rec}$ [kN]	-	-	0,05	0,08	0,08	-	0,12	0,12
	$V_{Rec}$ [kN]	-	-	0,10	0,15	0,10	-	0,25	0,15
Autoclaved aerated concrete AAC 4, ACC 6	$N_{Rec}$ [kN]	-	-	0,08	0,10	0,10	-	0,15	0,15
	$V_{Rec}$ [kN]	-	-	0,10	0,12	0,10	-	0,30	0,20
Extruded brick, Boral 10	$N_{Rec}$ [kN]	0,05	0,10	0,15	0,20	0,20	0,25	0,35	0,35
	$V_{Rec}$ [kN]	0,15	0,25	0,30	0,40	0,25	0,50	0,90	0,55

a) With overall global safety factor  $\gamma = 5$  to the characteristic loads and a partial safety factor of  $\gamma = 1,4$  to the design values.

## Materials

### Material quality

Part	Material
Plastic sleeve	Polyamide 6.6
Screw	Carbon steel, galvanised to min. 5µm
	Stainless steel, grade A2
	Stainless steel, grade A2, copper-plated

## Setting information

### Installation temperature

-10 °C to +40°C

### Service temperature range

Hilti HPS-1 impact anchor may be applied in the temperature range below.

Temperature range	Base material temperature	Max. long term base material temperature	Max. short term base material temperature
Temperature range	-40 °C to +80 °C	+50 °C	+80 °C

### Max. short term base material temperature

Short-term elevated base material temperatures are those that occur over brief intervals, e.g. as a result of diurnal cycling.

### Max. long term base material temperature

Long-term elevated base material temperatures are roughly constant over significant periods of time.

### Setting details HPS-1

Anchor		HPS-1 4	HPS-1 5	HPS-1 6	HPS-1 8
Nominal diameter of drill bit	$d_o$ [mm]	4	5	6	8
Cutting diameter of drill bit	$d_{cut} \leq$ [mm]	4,35	5,35	6,4	8,45
Depth of drill hole	$h_1 \geq$ [mm]	25	30	40	50
Nominal embedment depth	$h_{nom}$ [mm]	20	20	25	30
Anchor length	$l$ [mm]	21,5	22 - 37	27 - 67	28,5 – 132,5
Max fixture thickness	$t_{fix}$ [mm]	2	15	40	100

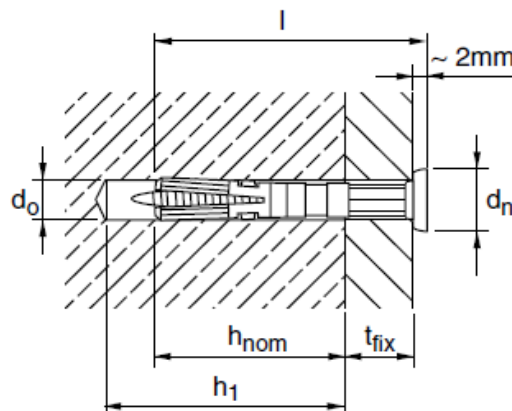



**Installation equipment**

Anchor	HPS-1 4	HPS-1 5	HPS-1 6	HPS-1 8
Rotary hammer	TE2 - TE16			
Other tools	Screwdriver			

**Setting parameters HPS-1**

Anchor			HPS-1 4	HPS-1 5	HPS-1 6	HPS-1 8
Minimum spacing	s	[mm]	20	25	30	35
Minimum edge distance	c	[mm]	20	25	30	35

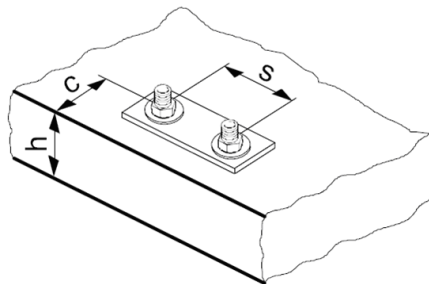
**Setting instruction**

\*For detailed information on installation see instruction for use given with the package of the product.

Setting instructions		
<b>1. Drill hole with drill bit</b> 	<b>2. Install anchor</b> 	<b>3. Hammer in anchor</b> 

### 3.5.5 HUD-1



# HUD-1 Plastic anchor

## Economical universal plastic anchor

### Anchor version



HUD-1  
(d5-d14)

### Benefits

- Flat setting
- Flexibility of screw length
- An anchor for every base material

### Base material



Concrete  
(non-cracked)

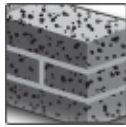

Solid brick

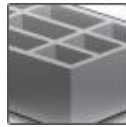

Hollow brick

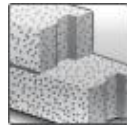

Autoclaved  
aerated  
concrete



Drywall

### Basic loading data

#### All data in this section applies to:

- Correct setting (See setting instruction)
- Load data are only valid for the specified wood screw type
- No edge distance and spacing influence
- Base material as specified in the table
- Minimum base material thickness

**Anchorage depth**

Anchor size		5x25	6x30	8x40	10x50	12x60	14x70
Nominal anchorage depth	$h_{nom}$ [mm]	25	30	40	50	60	70

**Characteristic resistance**

Anchor size		5x25		6x30		8x40		10x50		12x60	14x70
Screw type <sup>d)</sup>		W	C	W	C	W	C	W	C	W	W
Size		4	4	5	5	6	6	8	8	10	12
DIN		96		96		96		96		571	571
Concrete $\geq$ C16/20	$N_{Rk}$ [kN]	1,5	0,5	2,75	1,75	4,25	2,5	7	-	10	15
	$V_{Rk}$ [kN]	2	-	4,5	-	6,25	-	11	-	15	28
Solid clay brick Mz 20	$N_{Rk}$ [kN]	0,85	0,3	1,75	0,75	3	1,75	4	-	5	5 <sup>c)</sup>
	$V_{Rk}$ [kN]	1,2	-	1,5	-	2,2	-	-	-	-	-
Solid sand-lime Brick KS 12	$N_{Rk}$ [kN]	1,25	0,75	2,5	1,5	4,25	2	5	-	7,5	7,5 <sup>c)</sup>
	$V_{Rk}$ [kN]	1,25	-	2,8	-	3,7	-	6,6	-	-	-
Hollow clay brick HlzB 12	$N_{Rk}$ [kN]	0,4	0,25	0,5	0,4	1	0,6	1,25	-	1,4	1,6
	$V_{Rk}$ [kN]	1,15	-	1,75	-	-	-	-	-	-	-
Hollow clay brick HlzB 12 – 15mm plastered	$N_{Rk}$ [kN]	0,4	0,25	0,75	0,5	1,25	0,75	1,5	-	1,75	2
	$V_{Rk}$ [kN]	1,15	-	1,75	-	-	-	-	-	-	-
Autoclaved aerated concrete AAC 2	$N_{Rk}$ [kN]	0,3	0,2	0,5	0,3	0,75	0,5	1	-	1,25	1,5
	$V_{Rk}$ [kN]	0,2	-	0,25	-	0,4	-	-	-	-	-
Autoclaved aerated concrete AAC 4	$N_{Rk}$ [kN]	0,5	0,3	0,75	0,5	1,5	1	2	-	2,5	3
	$V_{Rk}$ [kN]	0,65	-	0,9	-	1,5	-	-	-	-	-
Gypsum board Thickness 12,5mm	$N_{Rk}$ [kN]	0,2	0,3	0,25	0,4	0,3	0,5	-	0,75 <sup>a)</sup>	-	-
	$V_{Rk}$ [kN]	0,45	-	0,7	-	-	-	-	-	-	-
Gypsum board Thickness 2x12,5mm	$N_{Rk}$ [kN]	0,3	0,3	0,4	0,4	0,5	0,5	0,75 <sup>a)</sup>	1 <sup>a)</sup>	1,5 <sup>b)</sup>	-
	$V_{Rk}$ [kN]	0,45	-	0,7	-	-	-	-	-	-	-
Fibre reinforced gypsum board Thickness 12,5mm	$N_{Rk}$ [kN]	0,45	-	0,6	-	0,9	-	-	-	-	-
	$V_{Rk}$ [kN]	0,72	-	0,96	-	1,44	-	-	-	-	-
Fibre reinforced gypsum board Thickness 2x12,5mm	$N_{Rk}$ [kN]	0,45	-	1,2	-	1,8	-	2,1	-	-	-
	$V_{Rk}$ [kN]	0,72	-	1,92	-	2,88	-	3,36	-	-	-

a) only with screw diameter 6mm

b) only with screw diameter 8mm

c) only with screw diameter 10mm

d) Screw type: W: Wood-screw C: Chipboard screw

Load data are valid for the mentioned woodscrew type, if other types or different screws are used the load capacity may decrease.

**Design resistance**

Anchor size		5x25		6x30		8x40		10x50		12x60	14x70
Screw type <sup>d)</sup>		W	C	W	C	W	C	W	C	W	W
Size		4	4	5	5	6	6	8	8	10	12
DIN		96		96		96		96		571	571
Concrete ≥ C16/20	N <sub>Rd</sub> [kN]	0,42	0,14	0,77	0,49	1,19	0,70	1,96	-	2,80	4,20
	V <sub>Rd</sub> [kN]	0,56	-	1,26	-	1,75	-	3,08	-	4,20	7,84
Solid clay brick Mz 20	N <sub>Rd</sub> [kN]	0,24	0,08	0,49	0,21	0,84	0,49	1,12	-	1,40	1,40 <sup>c)</sup>
	V <sub>Rd</sub> [kN]	0,34	-	0,42	-	0,62	-	-	-	-	-
Solid sand-lime brick KS 12	N <sub>Rd</sub> [kN]	0,35	0,21	0,70	0,42	1,19	0,56	1,40	-	2,10	2,10 <sup>c)</sup>
	V <sub>Rd</sub> [kN]	0,35	-	0,78	-	1,04	-	1,85	-	-	-
Hollow clay brick HlzB 12	N <sub>Rd</sub> [kN]	0,11	0,07	0,14	0,11	0,28	0,17	0,35	-	0,39	0,45
	V <sub>Rd</sub> [kN]	0,32	-	0,49	-	-	-	-	-	-	-
Hollow clay brick HlzB 12 – 15mm plastered	N <sub>Rd</sub> [kN]	0,11	0,07	0,21	0,14	0,35	0,21	0,42	-	0,49	0,56
	V <sub>Rd</sub> [kN]	0,32	-	0,49	-	-	-	-	-	-	-
Autoclaved aerated concrete AAC 2	N <sub>Rd</sub> [kN]	0,08	0,06	0,14	0,08	0,21	0,14	0,28	-	0,35	0,42
	V <sub>Rd</sub> [kN]	0,06	-	0,07	-	0,11	-	-	-	-	-
Autoclaved aerated concrete AAC 4	N <sub>Rd</sub> [kN]	0,14	0,08	0,21	0,14	0,42	0,28	0,56	-	0,70	0,84
	V <sub>Rd</sub> [kN]	0,18	-	0,25	-	0,42	-	-	-	-	-
Gypsum board Thickness 12,5mm	N <sub>Rd</sub> [kN]	0,06	0,08	0,07	0,11	0,08	0,14	-	0,21 <sup>a)</sup>	-	-
	V <sub>Rd</sub> [kN]	0,13	-	0,20	-	-	-	-	-	-	-
Gypsum board Thickness 2x12,5mm	N <sub>Rd</sub> [kN]	0,08	0,08	0,11	0,11	0,14	0,14	0,21 <sup>a)</sup>	0,28 <sup>a)</sup>	0,42 <sup>b)</sup>	
	V <sub>Rd</sub> [kN]	0,13	-	0,20	-	-	-	-	-	-	-
Fibre reinforced gypsum board Thickness 12,5mm	N <sub>Rd</sub> [kN]	0,13	-	0,17	-	0,25	-	-	-	-	-
	V <sub>Rd</sub> [kN]	0,20	-	0,27	-	0,40	-	-	-	-	-
Fibre reinforced gypsum board Thickness 2x12,5mm	N <sub>Rd</sub> [kN]	0,13	-	0,34	-	0,50	-	0,59	-	-	-
	V <sub>Rd</sub> [kN]	0,20	-	0,54	-	0,81	-	0,94	-	-	-

a) only with screw diameter 6mm

b) only with screw diameter 8mm

c) only with screw diameter 10mm

d) Screw type: W: Wood-screw C: Chipboard screw

Load data are valid for the mentioned woodscrew type, if other types or different screws are used the load capacity may decrease.

**Recommended loads<sup>e)</sup>**

Anchor size		5x25		6x30		8x40		10x50		12x60	14x70
Screw type <sup>d)</sup>		W	C	W	C	W	C	W	C	W	W
Size		4	4	5	5	6	6	8	8	10	12
DIN		96		96		96		96		571	571
Concrete ≥ C16/20	N <sub>Rec</sub> [kN]	0,3	0,1	0,55	0,35	0,85	0,5	1,4	-	2	3
	V <sub>Rec</sub> [kN]	0,4	-	0,9	-	1,25	-	2,2	-	3	5,6
Solid clay brick Mz 20	N <sub>Rec</sub> [kN]	0,17	0,06	0,35	0,15	0,6	0,35	0,8	-	1	1 <sup>c)</sup>
	V <sub>Rec</sub> [kN]	0,24	-	0,3	-	0,44	-	-	-	-	-
Solid sand-lime brick KS 12	N <sub>Rec</sub> [kN]	0,25	0,15	0,5	0,3	0,85	0,4	1	-	1,5	1,5 <sup>c)</sup>
	V <sub>Rec</sub> [kN]	0,25	-	0,56	-	0,74	-	1,32	-		
Hollow clay brick HlzB 12	N <sub>Rec</sub> [kN]	0,08	0,05	0,1	0,08	0,2	0,12	0,25	-	0,28	0,32
	V <sub>Rec</sub> [kN]	0,23	-	0,35	-	-	-	-	-	-	-
Hollow clay brick HlzB 12 – 15mm plastered	N <sub>Rec</sub> [kN]	0,08	0,05	0,15	0,1	0,25	0,15	0,3	-	0,35	0,4
	V <sub>Rec</sub> [kN]	0,23	-	0,35	-	-	-	-	-	-	-
Autoclaved aerated concrete AAC 2	N <sub>Rec</sub> [kN]	0,06	0,04	0,1	0,06	0,15	0,1	0,2	-	0,25	0,3
	V <sub>Rec</sub> [kN]	0,04	-	0,05		0,08			-		
Autoclaved aerated concrete AAC 4	N <sub>Rec</sub> [kN]	0,1	0,06	0,15	0,1	0,3	0,2	0,4	-	0,5	0,6
	V <sub>Rec</sub> [kN]	0,13	-	0,18	-	0,3	-	-	-	-	-
Gypsum board Thickness 12,5mm	N <sub>Rec</sub> [kN]	0,04	0,06	0,05	0,08	0,06	0,1	-	0,15 <sup>a)</sup>	-	-
	V <sub>Rec</sub> [kN]	0,09	-	0,14	-	-	-	-	-	-	-
Gypsum board Thickness 2x12,5mm	N <sub>Rec</sub> [kN]	0,06	0,06	0,08	0,08	0,1	0,1	0,15 <sup>a)</sup>	0,2 <sup>a)</sup>	0,3 <sup>b)</sup>	-
	V <sub>Rec</sub> [kN]	0,09	-	0,14	-	-	-	-	-	-	-
Fibre reinforced gypsum board Thickness 12,5mm	N <sub>Rec</sub> [kN]	0,09	-	0,12	-	0,18	-	-	-	-	-
	V <sub>Rec</sub> [kN]	0,14	-	0,19	-	0,29	-	-	-	-	-
Fibre reinforced gypsum board Thickness 2x12,5mm	N <sub>Rec</sub> [kN]	0,09	-	0,24	-	0,36	-	0,42	-	-	-
	V <sub>Rec</sub> [kN]	0,14	-	0,38	-	0,58	-	0,67	-	-	-

a) only with screw diameter 6mm

b) only with screw diameter 8mm

c) only with screw diameter 10mm

d) Screw type: W: Wood-screw C: Chipboard screw

Load data are valid for the mentioned woodscrew type, if other types or different screws are used the load capacity may decrease.

 e) With overall global safety factor  $\gamma = 5$  to the characteristic loads and a partial safety factor of  $\gamma = 1,4$  to the design values.

## Materials

### Material quality

Part	Material
Plastic sleeve	Polyamide 6

## Setting information

### Installation temperature

-10°C to +40°C

### Service temperature range

Hilti HUD-1 universal anchor may be applied in the temperature range given below.

Temperature range	Base material temperature	Max. long term base material temperature	Max. short term base material temperature
Temperature range I	-40 °C to +80 °C	+50 °C	+80 °C

### Max short term base material temperature

Short-term elevated base material temperatures are those that occur over brief intervals, e.g. as a result of diurnal cycling.

### Max long term base material temperature

Long-term elevated base material temperatures are roughly constant over significant periods of time.

## Setting details

Anchor size		5x25	6x30	8x40	10x50	12x60	14x70
Nominal diameter of drill bit	$d_o$ [mm]	5	6	8	10	12	14
Cutting diameter of drill bit	$d_{cut} \leq$ [mm]	5,35	6,4	8,45	10,45	12,5	14,5
Depth of drill hole	$h_1 \geq$ [mm]	35	40	55	65	80	90
Nominal anchorage depth	$h_{nom}$ [mm]	25	30	40	50	60	70
Anchor length	$l$ [mm]	25	30	40	50	60	70
Max fixture thickness	$t_{fix}$ [mm]	Depending on screw length					
Woodscrew diameter <sup>a)</sup>	$d$ [mm]	3,5 - 4	4,5 - 5	5 - 6	7 - 8	8 - 10	10 - 12

a) The basic loading data are depending on the woodscrew diameters, if other types or different screws are used the load capacity may decrease. **Highlighted diameters** refer to basic loading data table, except footnotes <sup>a), b), c)</sup> of basic loading data tables.

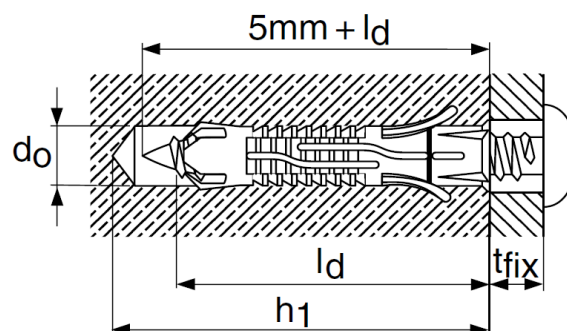

## Installation equipment

Anchor size	5x25	6x30	8x40	10x50	12x60	14x70	5x25
Rotary hammer	TE 2 - TE16						
Other tools	Screwdriver						

**Setting instruction<sup>a)</sup>**

**\*For detailed information on installation see instruction for use given with the package of the product.**

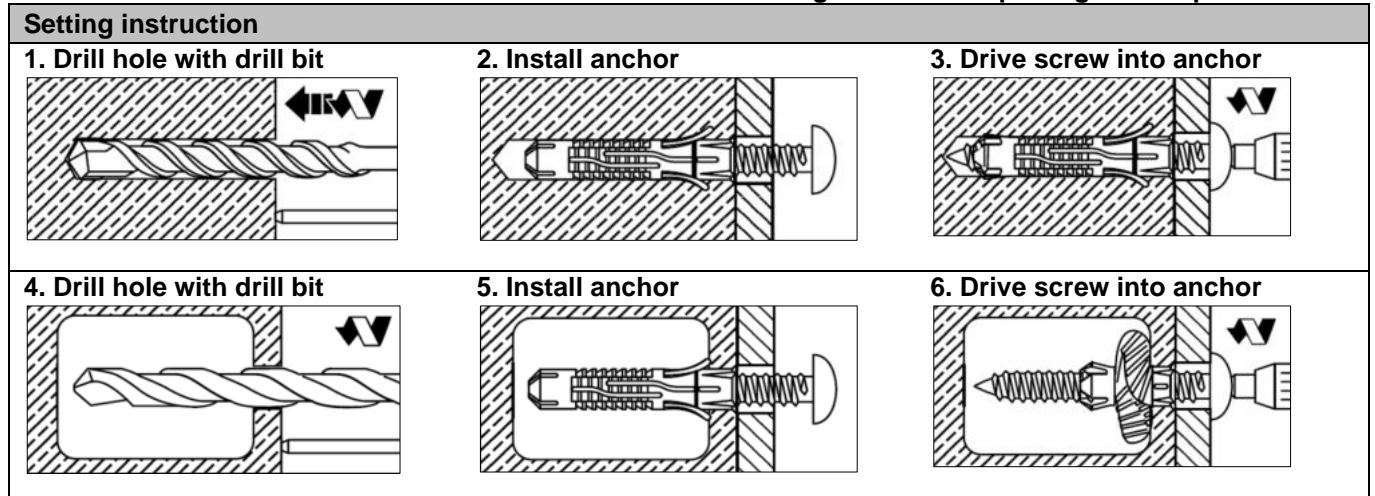

a) Use only for wall and floor applications. Not applicable for ceiling and façade applications.



### 3.5.6 HUD-2

 **Go back to the table of content**  
Push this button

 **Go back to the anchor selector**  
Push this button

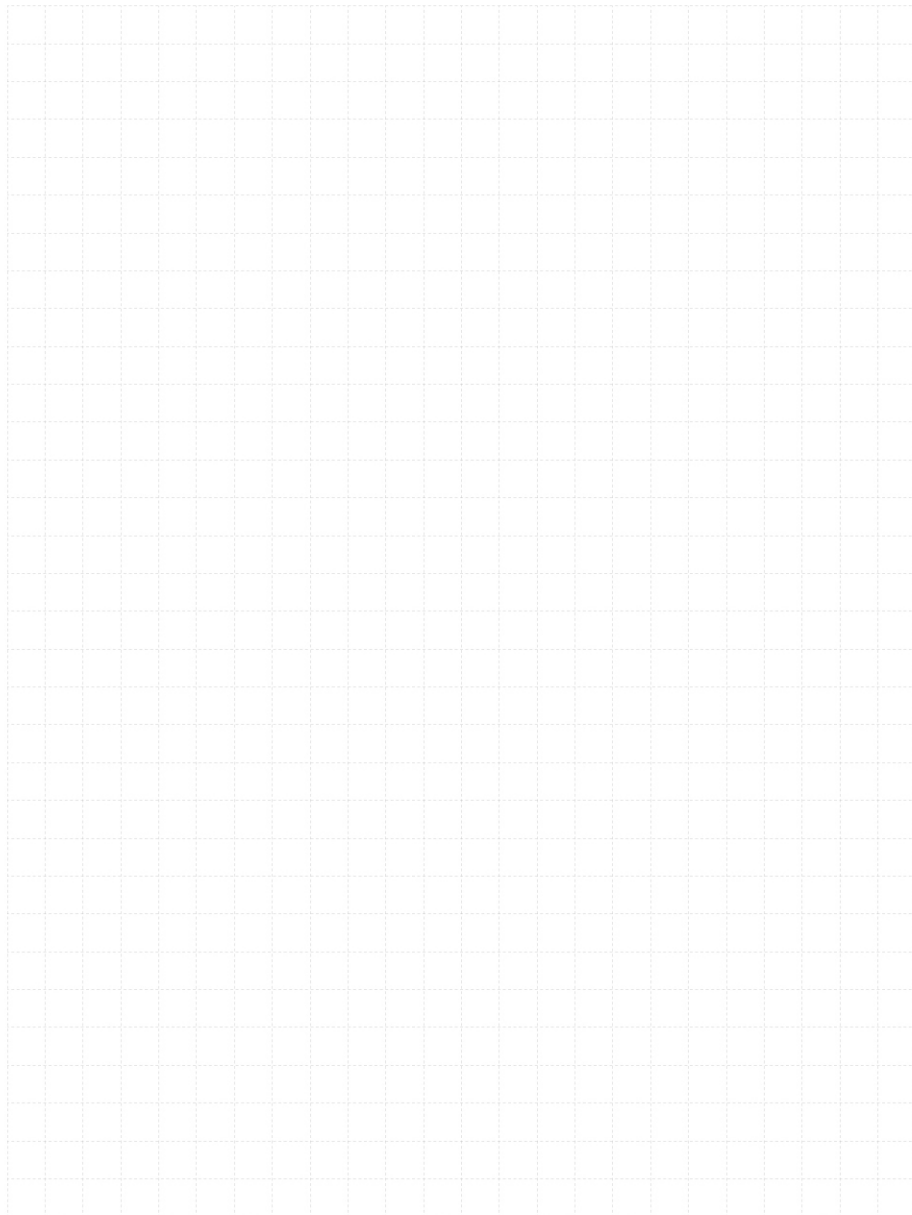

# HUD-2 Plastic anchor

## Economical universal plastic anchor

### Anchor version



HUD-2  
(5, 6, 8)

### Benefits

- Flat setting
- Flexibility of screw length
- An anchor for every base material

### Base material



Concrete  
(non-cracked)

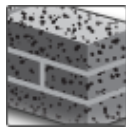

Solid brick

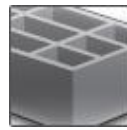

Hollow brick

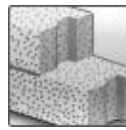

Autoclaved  
aerated  
concrete



Drywall

### Basic loading data

#### All data in this section applies to:

- Correct setting (see setting instruction)
- Load data are only valid for the specified chipboard screw type
- No edge distance and spacing influence
- Base material as specified in the table
- Minimum base material thickness
- Load data given in the tables is independent of load direction

**Anchorage depth**

Anchor size		5x25	6x30	8x40
Nominal embedment depth	$h_{nom}$ [mm]	25	30	40

**Characteristic resistance**

Anchor size			HUD-2 5x25	HUD-2 6x30	HUD-2 8x40
Screw type			Chipboard screw 4x40 <sup>a)</sup>	Chipboard screw 5x50 <sup>b)</sup>	Chipboard screw 6x50 <sup>c)</sup>
Base material	Drilling mode				
Concrete, uncracked Strength $\geq$ C16/20	hammer	$F_{Rk}$ [kN]	0,60	1,2	2,5
Solid clay brick Name: Mauerziegel MZ Manuf.: Ziegelwerk Klosterbeuren Size : NF Strength: $\geq$ 20	hammer	$F_{Rk}$ [kN]	0,60	0,90	2,50
Hollow clay brick Name: ThermoPlan Planziegel-TS <sup>2</sup> 1,2 Manuf.: Ziegelwerk Klosterbeuren Size : 373x175x249 mm Strength class: $\geq$ 12	rotary	$F_{Rk}$ [kN]	0,60	0,80	1,20
Autoclaved aerated concrete Name: AAC 4 Manuf.: Ytong Size : 625x250x250 mm Strength: $\geq$ 6	rotary	$F_{Rk}$ [kN]	0,30	0,60	0,90
Drywall, single layer 12,5 Name: Bauplatte Manuf.: Knauff Size : 2000x1250x12,5 mm	rotary	$F_{Rk}$ [kN]	0,15	0,15	0,15
Drywall, double layer 2x12,5 Name: Bauplatte Manuf.: Knauff Size : 2000x1250x12,5 mm	rotary	$F_{Rk}$ [kN]	0,20	0,25	0,40
Fibre reinf. drywall, single layer 12,5 Name: Vidiwall Manuf.: Knauff Size : 1250x1000x12,5 mm	rotary	$F_{Rk}$ [kN]	0,50	0,60	0,60

a) chipboard screw 4x40: outer diameter 3,9 mm, core diameter 2,4 mm

b) chipboard screw 5x50: outer diameter 4,8 mm, core diameter 2,9 mm

c) chipboard screw 6x50: outer diameter 5,8 mm, core diameter 3,8 mm

**Design resistance <sup>d)</sup>**

Anchor size			HUD-2 5x25	HUD-2 6x30	HUD-2 8x40
Screw type			Chipboard screw 4x40 <sup>a)</sup>	Chipboard screw 5x50 <sup>b)</sup>	Chipboard screw 6x50 <sup>c)</sup>
Base material	Drilling mode				
Concrete, uncracked Strength $\geq$ C16/20	hammer	$F_{Rd}$ [KN]	0,33	0,67	1,4
Solid clay brick Name: Mauerziegel MZ Manuf.: Ziegelwerk Klosterbeuren Size : NF Strength: $\geq$ 20	hammer	$F_{Rd}$ [KN]	0,24	0,36	1,00
Hollow clay brick Name: ThermoPlan Planziegel-TS <sup>2</sup> 1,2 Manuf.: Ziegelwerk Klosterbeuren Size : 373x175x249 mm Strength class: $\geq$ 12	rotary	$F_{Rd}$ [KN]	0,24	0,32	0,48
Autoclaved aerated concrete Name: AAC 4 Manuf.: Ytong Size : 625x250x250 mm Strength: $\geq$ 6	rotary	$F_{Rd}$ [KN]	0,15	0,30	0,45
Drywall, single layer 12,5 Name: Bauplatte Manuf.: Knauff Size : 2000x1250x12,5 mm	rotary	$F_{Rd}$ [KN]	0,06	0,06	0,06
Drywall, double layer 2x12,5 Name: Bauplatte Manuf.: Knauff Size : 2000x1250x12,5 mm	rotary	$F_{Rd}$ [KN]	0,08	0,10	0,16
Fibre reinf. drywall, single layer 12,5 Name: Vidiwall Manuf.: Knauff Size : 1250x1000x12,5 mm	rotary	$F_{Rd}$ [KN]	0,20	0,24	0,24

a) chipboard screw 4x40: outer diameter 3,9 mm, core diameter 2,4 mm

b) chipboard screw 5x50: outer diameter 4,8 mm, core diameter 2,9 mm

c) chipboard screw 6x50: outer diameter 5,8 mm, core diameter 3,8 mm

d) with partial safety factor factors  $\gamma_M = 1,8$  for concrete;  $\gamma_M = 2,0$  for AAC,  $\gamma_M = 2,5$  for masonry,  $\gamma_M = 2,5$  for drywall

**Recommended loads <sup>d)</sup>**

Anchor size		HUD-2 5x25	HUD-2 6x30	HUD-2 8x40	
Screw type		Chipboard screw 4x40 <sup>a)</sup>	Chipboard screw 5x50 <sup>b)</sup>	Chipboard screw 6x50 <sup>c)</sup>	
Base material	Drilling mode				
Concrete, uncracked Strength $\geq$ C16/20	hammer	$F_{rec}$ [KN]	0,24	0,48	1,0
Solid clay brick Name: Mauerziegel MZ Manuf.: Ziegelwerk Klosterbeuren Size : NF Strength: $\geq$ 20	hammer	$F_{rec}$ [KN]	0,17	0,26	0,71
Hollow clay brick Name: ThermoPlan Planziegel-TS <sup>2</sup> 1,2 Manuf.: Ziegelwerk Klosterbeuren Size : 373x175x249 mm Strength class: $\geq$ 12	rotary	$F_{rec}$ [KN]	0,17	0,23	0,34
Autoclaved aerated concrete Name: AAC 4 Manuf.: Ytong Size : 625x250x250 mm Strength: $\geq$ 6	rotary	$F_{rec}$ [KN]	0,11	0,21	0,32
Drywall, single layer 12,5 Name: Bauplatte Manuf.: Knauff Size : 2000x1250x12,5 mm	rotary	$F_{rec}$ [KN]	0,04	0,04	0,04
Drywall, double layer 2x12,5 Name: Bauplatte Manuf.: Knauff Size : 2000x1250x12,5 mm	rotary	$F_{rec}$ [KN]	0,06	0,07	0,11
Fibre reinf. drywall, single layer 12,5 Name: Vidiwall Manuf.: Knauff Size : 1250x1000x12,5 mm	rotary	$F_{rec}$ [KN]	0,14	0,17	0,17

a) chipboard screw 4x40: outer diameter 3,9 mm, core diameter 2,4 mm

b) chipboard screw 5x50: outer diameter 4,8 mm, core diameter 2,9 mm

c) chipboard screw 6x50: outer diameter 5,8 mm, core diameter 3,8 mm

d) with additional safety factor  $\gamma = 1,4$  to design values

## Materials

### Material quality

Part	Material
Plastic sleeve	Polyamide 6

## Setting information

### Installation temperature

-10°C to +40°C

### Service temperature range

Hilti HUD-2 universal anchor may be applied in the temperature range given below.

Temperature range	Base material temperature	Max. long term base material temperature	Max. short term base material temperature
Temperature range I	-40 °C to +80 °C	+50 °C	+80 °C

### Max short term base material temperature

Short-term elevated base material temperatures are those that occur over brief intervals, e.g. as a result of diurnal cycling.

### Max long term base material temperature

Long-term elevated base material temperatures are roughly constant over significant periods of time.

## Installation parameters

Anchor size		5x25	6x30	8x40
Nominal diameter of drill bit	$d_0$ [mm]	5	6	8
Cutting diameter of the drill bit	$d_{cut} \leq$ [mm]	5,4	6,4	8,45
Nominal embedment depth	$l_d$ [mm]	25	30	40
Recommended length of screw in base material	[mm]	$\geq 30$	$\geq 35$	$\geq 45$
Drill hole depth	$h_0$ [mm]	$\geq 30$	$\geq 35$	$\geq 45$
Minimum spacing	$s_{min}$ [mm]	Not determined		
Minimum edge distance	$c_{min}$ [mm]	Not determined		

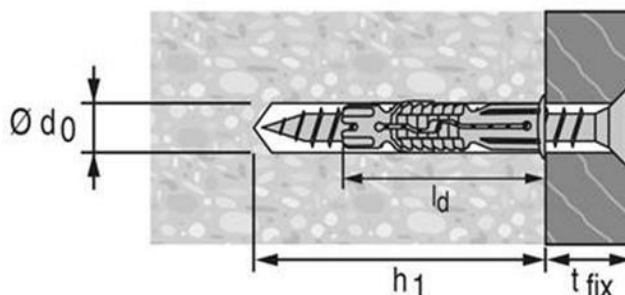

## Installation equipment

Anchor size	5x25	6x30	8x40
Rotary hammer	TE 2 - TE16		
Other tools	Screwdriver		

**Setting instruction<sup>a)</sup>**

\*For detailed information on installation see instruction for use given with the package of the product.

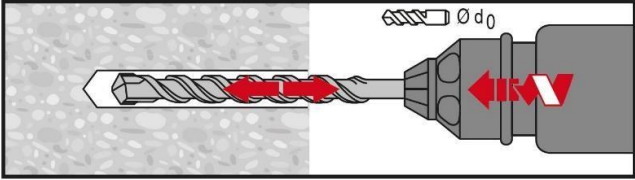
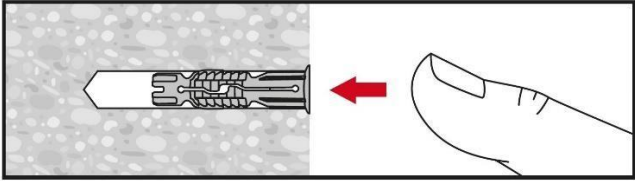
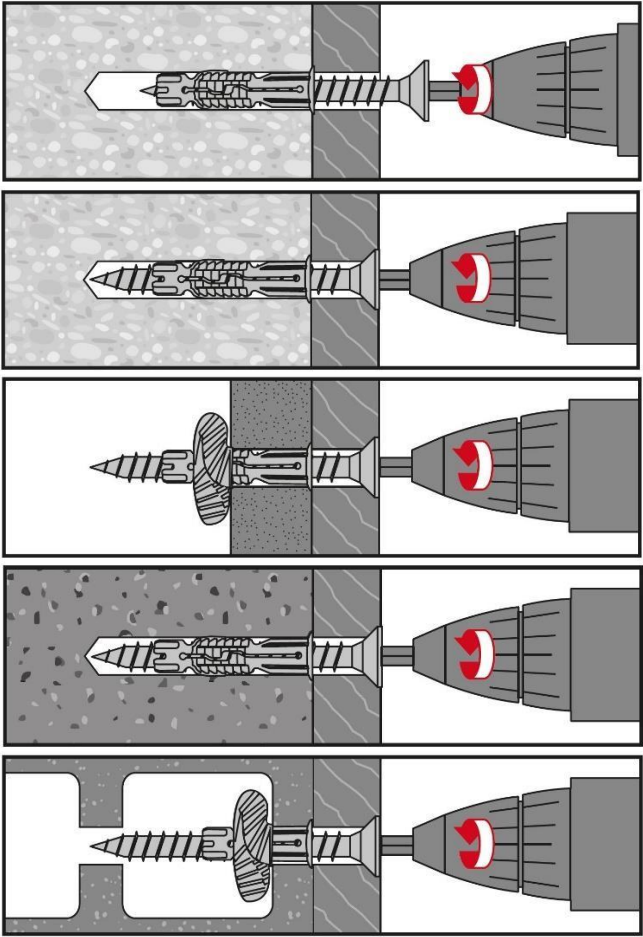
Setting instruction	
	<b>1. Drill hole with drill bit</b>
	<b>2. Install anchor</b>
	<b>3. Drive screw into anchor</b>

a) Use only for wall and floor applications. Not applicable for ceiling and façade applications.

### 3.5.7 HUD-L

 **Go back to the table of content**  
Push this button

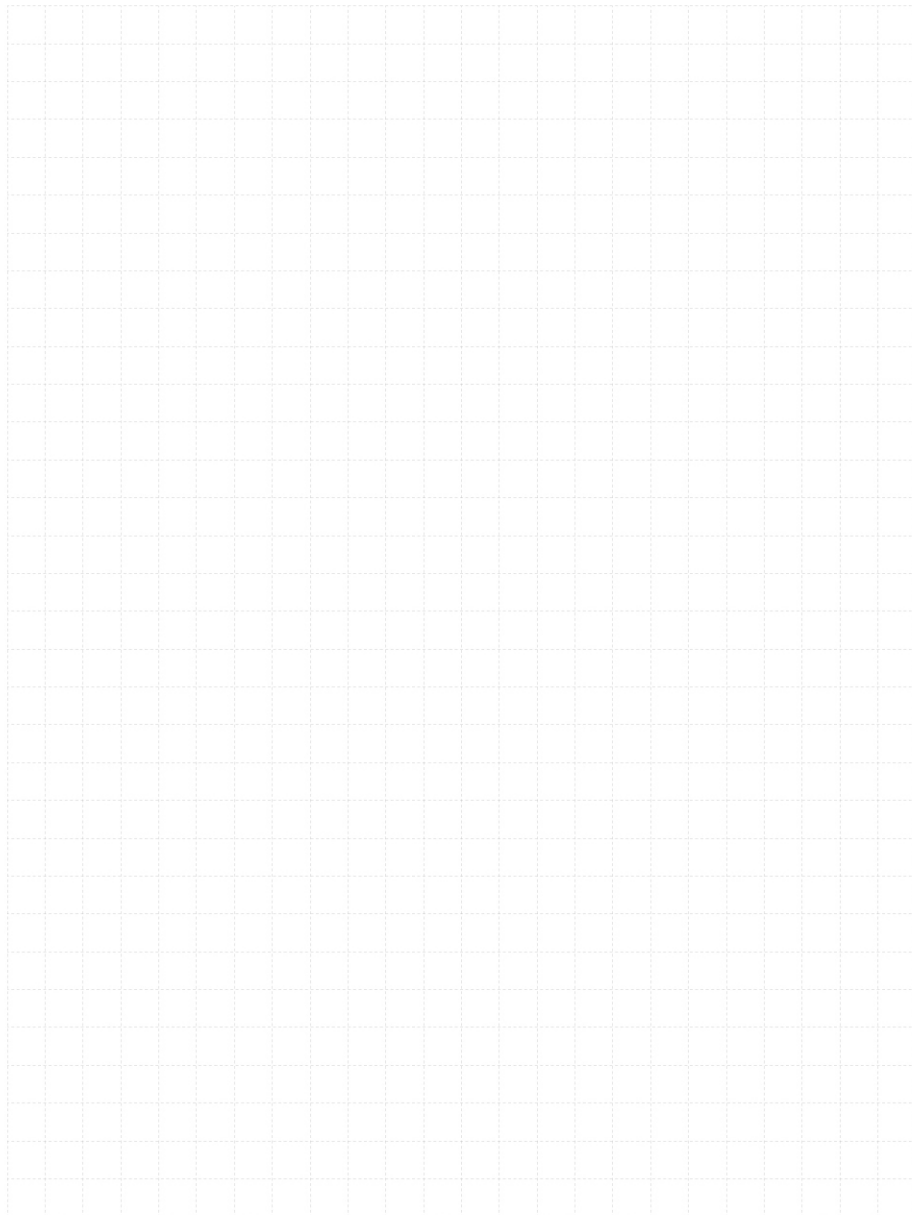

 **Go back to the anchor selector**  
Push this button







# HUD-L Plastic anchors

## Economical universal long plastic anchor

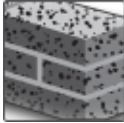
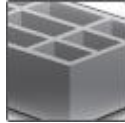
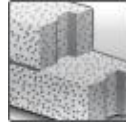
Anchor version		Benefits
	HUD-L (d6-d8)	<ul style="list-style-type: none"> <li>- Universal plastic anchor for weak base materials and renovation</li> <li>- For many base materials</li> <li>- Daily application</li> <li>- Excellent setting behaviour</li> </ul>
	HUD-L (d10)	

Base material				
				
Concrete (Non-cracked)	Solid brick	Hollow brick	Autoclaved aerated concrete	Drywall

Basic loading data	
<b>All data in this section applies to:</b>	
-	Correct setting (See setting instruction)
-	Load data are only valid for the specified woodscrew type
-	Load data given in the tables is independent of load direction
-	No edge distance and spacing influence
-	Base material as specified in the table
-	Minimum base material thickness

### Anchorage depth

Anchor size		6x50	8x60	10x70
Nominal embedment depth	$h_{nom}$ [mm]	47	57	70

### Characteristic resistance

Anchor size		6x50	8x60	10x70
<b>Screw type</b> <sup>c) d)</sup>		W	W	W
<b>Size</b>		4,5x80	5x90	8
<b>DIN</b>		96	96	571
Concrete $\geq$ C16/20	$F_{Rk}$ [kN]	1,15	1,4	9,0
Solid clay brick Mz 12	$F_{Rk}$ [kN]	0,85	1,0	-
Solid clay brick Mz 20	$F_{Rk}$ [kN]	-	-	7,0
Solid sand-lime brick KS 12	$F_{Rk}$ [kN]	0,85	1,0	2
Hollow clay brick Hlz 12 <sup>a)</sup>	$F_{Rk}$ [kN]	0,5	0,75	1,5
Hollow sand-lime brick KSL 12	$F_{Rk}$ [kN]	0,7	0,8	-
Autoclaved aerated concrete AAC 2 <sup>a)</sup>	$F_{Rk}$ [kN]	0,25	0,55	2,0
Gypsum board Thickness 2x12,5mm <sup>a)</sup>	$F_{Rk}$ [kN]	0,3	0,7	0,6 <sup>b)</sup>

a) Drilling without hammering

b) Suitable for fitting hexagonal screws by hand

c) Load data are valid for the mentioned woodscrew type, if other types or different screws are used the load capacity may decrease.

d) Screw type: W: Wood-screw

**Design resistance**

Anchor size		6x50	8x60	10x70
Screw type <sup>c) d)</sup>		W	W	W
Size		4,5x80	5x90	8
DIN		96	96	571
Concrete $\geq$ C16/20	F <sub>Rd</sub> [kN]	0,32	0,39	2,52
Solid clay brick Mz 12	F <sub>Rd</sub> [kN]	0,24	0,28	-
Solid clay brick Mz 20	F <sub>Rd</sub> [kN]	-	-	1,96
Solid sand-lime brick KS 12	F <sub>Rd</sub> [kN]	0,24	0,28	0,56
Hollow clay brick Hlz 12 <sup>a)</sup>	F <sub>Rd</sub> [kN]	0,14	0,21	0,42
Hollow sand-lime brick KSL 12	F <sub>Rd</sub> [kN]	0,20	0,22	-
Autoclaved aerated concrete AAC 2 <sup>a)</sup>	F <sub>Rd</sub> [kN]	0,07	0,15	0,56
Gypsum board Thickness 2x12,5mm <sup>a)</sup>	F <sub>Rd</sub> [kN]	0,08	0,20	0,17 <sup>b)</sup>

a) Drilling without hammering

b) Suitable for fitting hexagonal screws by hand

c) Load data are valid for the mentioned woodscrew type, if other types or different screws are used the load capacity may decrease.

d) Screw type: W: Wood-screw

**Recommended loads <sup>e)</sup>**

Anchor size		6x50	8x60	10x70
Screw type <sup>c) d)</sup>		W	W	W
Size		4,5x80	5x90	8
DIN		96	96	571
Concrete $\geq$ C16/20	F <sub>Rec</sub> [kN]	0,23	0,28	1,8
Solid clay brick Mz 12	F <sub>Rec</sub> [kN]	0,17	0,2	-
Solid clay brick Mz 20	F <sub>Rec</sub> [kN]	-	-	1,4
Solid sand-lime brick KS 12	F <sub>Rec</sub> [kN]	0,17	0,2	0,4
Hollow clay brick Hlz 12 <sup>a)</sup>	F <sub>Rec</sub> [kN]	0,1	0,15	0,3
Hollow sand-lime brick KSL 12	F <sub>Rec</sub> [kN]	0,14	0,16	-
Autoclaved aerated concrete AAC 2 <sup>a)</sup>	F <sub>Rec</sub> [kN]	0,05	0,11	0,4
Gypsum board Thickness 2x12,5mm <sup>a)</sup>	F <sub>Rec</sub> [kN]	0,06	0,14	0,12 <sup>b)</sup>

a) Drilling without hammering

b) Suitable for fitting hexagonal screws by hand

c) Load data are valid for the mentioned woodscrew type, if other types or different screws are used the load capacity may decrease.

d) Screw type: W: Wood-screw

e) With overall global safety factor  $\gamma = 5$  to the characteristic loads and a partial safety factor of  $\gamma = 1,4$  to the design values.

## Materials

### Material quality

Part	Material
Plastic sleeve	Polyamide 6

## Setting information

### Installation temperature

-10°C to + 40°C

### Service temperature range

Hilti HUD-L universal anchor may be applied in the temperature range given below.

Temperature range	Base material temperature	Max. long term base material temperature	Max. short term base material temperature
Temperature range	-40 °C to +80 °C	+50 °C	+80 °C

### Max short term base material temperature

Short-term elevated base material temperatures are those that occur over brief intervals, e.g. as a result of diurnal cycling.

### Max long term base material temperature

Long-term elevated base material temperatures are roughly constant over significant periods of time.

## Setting parameters

Anchor size		6x50	8x60	10x70
Nominal diameter of drill bit	$d_o$ [mm]	6	8	10
Cutting diameter of drill bit	$d_{cut} \leq$ [mm]	6,4	8,45	10,45
Depth of drill hole	$h_1 \geq$ [mm]	70	80	90
Nominal embedment depth	$h_{nom}$ [mm]	47	57	70
Anchor length	$l$ [mm]	47	57	70
Max fixture thickness	$t_{fix}$ [mm]	Depending on screw length		
Recommended length of screw in base material	$l_d$ [mm]	55	65	75
Woodscrew diameter <sup>a)</sup>	$d$ [mm]	4,5 - 5	5 - 6	7 - 8

a) The basic loading data are depending on the woodscrew diameters, if other types or different screws are used the load capacity may decrease. Highlighted diameters refer to basic loading data table, except footnotes <sup>a), b), c)</sup> of basic loading data tables.

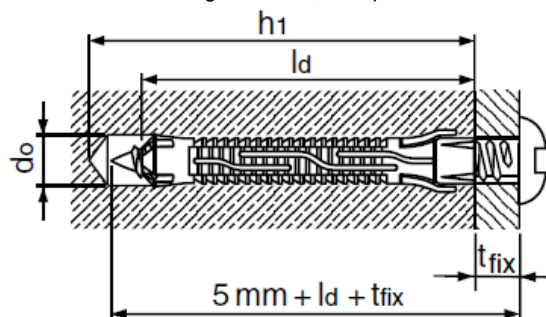

## Installation equipment

Anchor size	6x50	8x60	10x70
Rotary hammer		TE 2- TE16	
Other tools		Screwdriver	

**Setting instruction <sup>a)</sup>**

**\*For detailed information on installation see instruction for use given with the package of the product.**

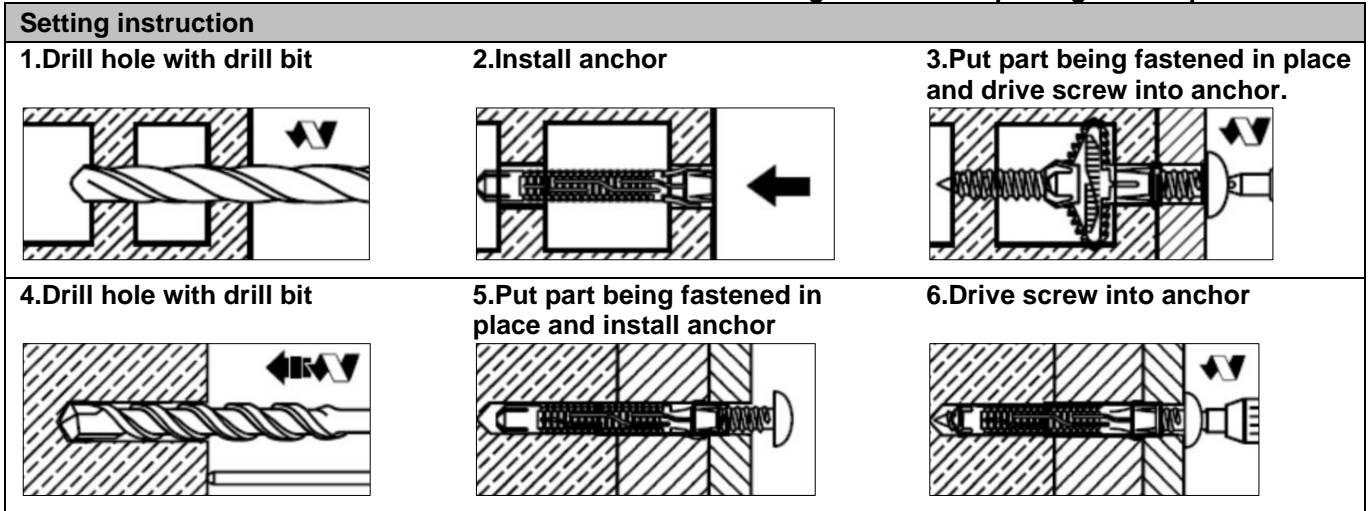

a) Use only for wall and floor applications. Not applicable for ceiling and façade applications.

### 3.5.8 HLD

 **Go back to the table of content**  
Push this button

 **Go back to the anchor selector**  
Push this button

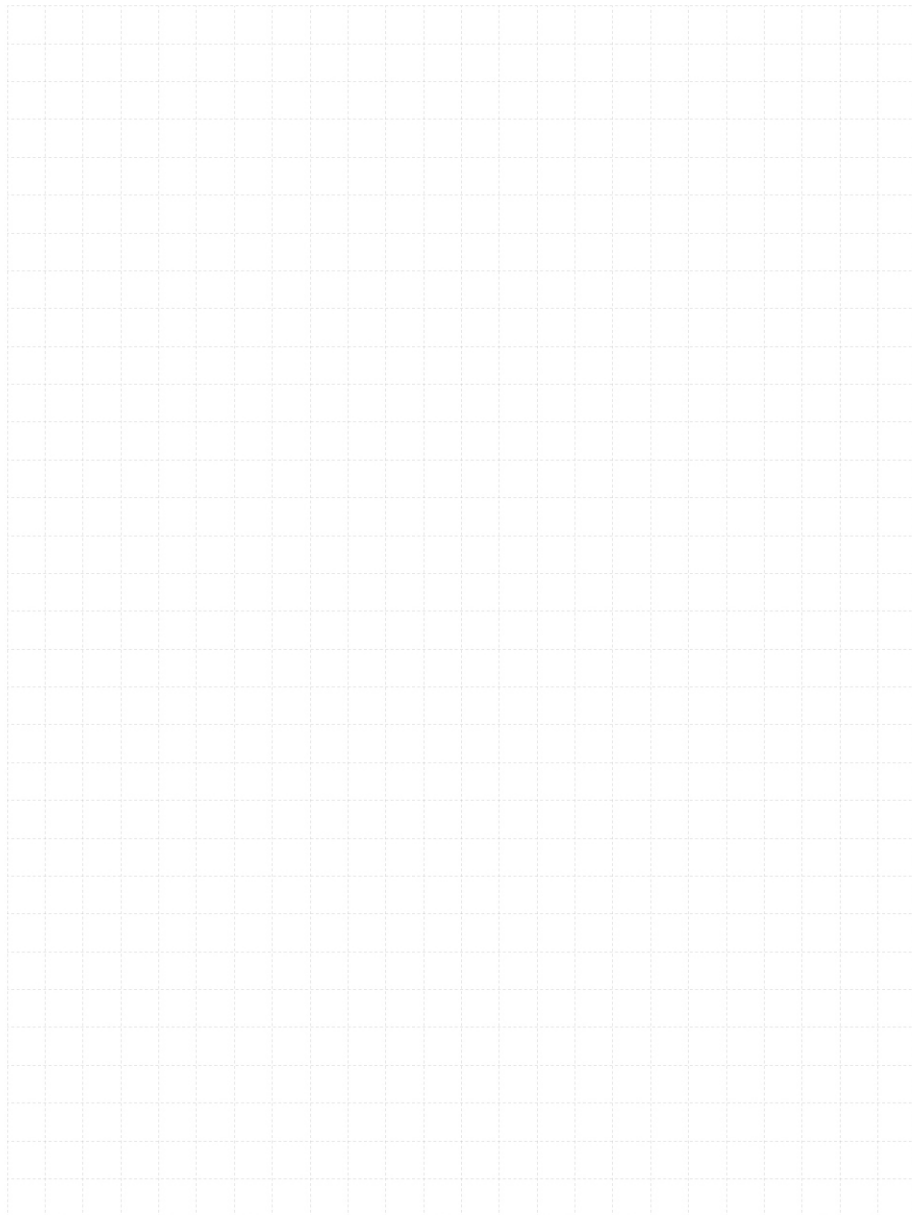

# HLD Plastic anchors

## Economical plastic anchor for drywall

### Anchor version



HLD  
(d10)

### Benefits

- Plastic undercut anchor
- Simple setting
- Drywall application

### Base material



Drywall

### Basic loading data

#### All data in this section applies to:

- Correct setting (See setting instruction)
- No edge distance and spacing influence
- Base material as specified in the table
- Load data given in the tables is independent of load direction

#### Characteristic resistance

Anchor size			HLD 2	HLD 3	HLD 4
Anchoring principle <sup>a)</sup>					
Gypsum board Thickness 12,5mm	B	$F_{Rk}$ [kN]	0,4	0,4	0,4
Fibre reinforced gypsum board Thickness 12,5mm	A	$F_{Rk}$ [kN]	0,3	-	-
Fibre reinforced gypsum board Thickness 2x12,5mm	A	$F_{Rk}$ [kN]	-	0,6	-
Hollow clay brick	A / B	$F_{Rk}$ [kN]	0,75	0,75	
Concrete $\geq$ C16/20	C	$F_{Rk}$ [kN]	1,25	2	2,5

a) See setting details

#### Design resistance

Anchor size			HLD 2	HLD 3	HLD 4
Anchoring principle <sup>a)</sup>					
Gypsum board Thickness 12,5mm	B	$F_{Rd}$ [kN]	0,11	0,11	0,11
Fibre reinforced gypsum board Thickness 12,5mm	A	$F_{Rd}$ [kN]	0,08	-	-
Fibre reinforced gypsum board Thickness 2x12,5mm	A	$F_{Rd}$ [kN]	-	0,17	-
Hollow clay brick	A / B	$F_{Rd}$ [kN]	0,21	0,21	-
Concrete $\geq$ C16/20	C	$F_{Rd}$ [kN]	0,35	0,56	0,70

a) See setting detail

**Recommended loads <sup>b)</sup>**

Anchor size			HLD 2	HLD 3	HLD 4
Anchoring principle <sup>a)</sup>					
Gypsum board Thickness 12,5mm	B	F <sub>Rec</sub> [kN]	0,08	0,08	0,08
Fibre reinforced gypsum board Thickness 12,5mm	A	F <sub>Rec</sub> [kN]	0,06	-	-
Fibre reinforced gypsum board Thickness 2x12,5mm	A	F <sub>Rec</sub> [kN]	-	0,12	-
Hollow clay brick	A / B	F <sub>Rec</sub> [kN]	0,15	0,15	
Concrete ≥ C16/20	C	F <sub>Rec</sub> [kN]	0,25	0,4	0,5

a) See setting details

b) With overall global safety factor  $\gamma = 5$  to the characteristic loads and a partial safety factor of  $\gamma = 1,4$  to the design value.

**Materials**
**Material quality**

Part	Material
Sleeve	Polyamide PA 6

**Setting information**
**Installation temperature**

-10°C to + 40°C

**Service temperature range**

Hilti HLD universal anchor may be applied in the temperature range given below.

Temperature range	Base material temperature	Max. long term base material temperature	Max. short term base material temperature
Temperature range	-40 °C to +80 °C	+50 °C	+80 °C

**Max short term base material temperature**

Short-term elevated base material temperatures are those that occur over brief intervals, e.g. as a result of diurnal cycling.

**Max long term base material temperature**

Long-term elevated base material temperatures are roughly constant over significant periods of time.

**Setting details**

Anchor size		HLD 2	HLD 3	HLD 4
Nominal diameter of drill bit	$d_o$ [mm]	10		
Depth of drill hole	(only anchoring principle C) $h_1 \geq$ [mm]	50	56	66
Screw length	(anchoring principle A/B) $l_s$ [mm]	$33 + t_{fix}$	$40 + t_{fix}$	$49 + t_{fix}$
	(anchoring principle C) $l_s$ [mm]	$40 + t_{fix}$	$46 + t_{fix}$	$56 + t_{fix}$
Screw diameter	(anchoring principle A/B) $d_s$ [mm]	4 - 5		
	(anchoring principle C) $d_s$ [mm]	5 - 6		
Wall / panel thickness	(anchoring principle A) $h$ [mm]	4 - 12	15 - 19	24 - 28
	(anchoring principle B) $h$ [mm]	12 - 16	19 - 25	28 - 32
	(anchoring principle C) $h$ [mm]	35	42	50

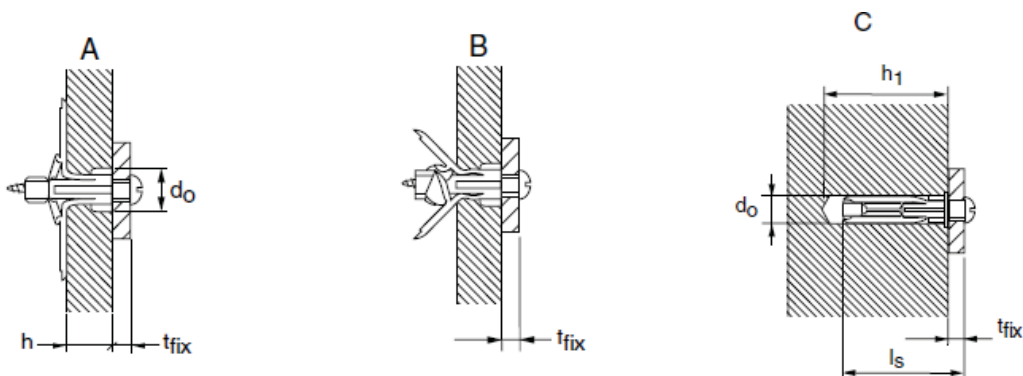
**Installation equipment**

Anchor size	HLD 2	HLD 3	HLD 4
Rotary hammer	TE 2- TE16		
Other tools	Screwdriver		

**Setting instruction**

\*For detailed information on installation see instruction for use given with the package of the product.

Setting instruction	
<b>1. Drill hole with drill bit</b> 	<b>2. Install anchor</b> 
<b>3. Install anchor</b> 	<b>4. Drive in the screw</b> 





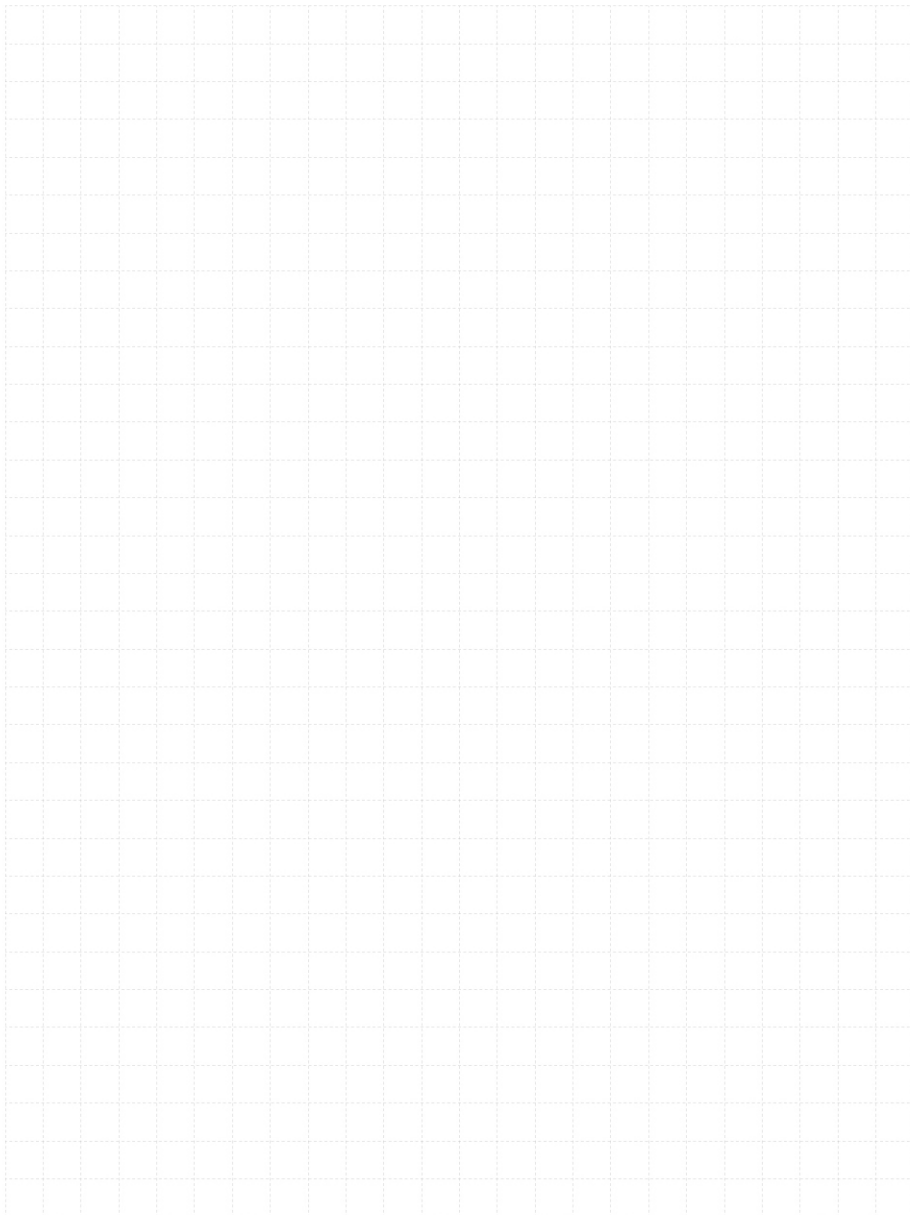

### 3.5.9 HMF



# HMF plastic anchor

## Economical universal plastic anchor

Anchor version		Benefits
	HMF	- Flat setting - An anchor for every base material
	CS: Countersunk screw	- Suitable for fastening through in-place parts - Resists rotation in hole and premature expansion
	PH: Pan head screw	- High reliability and precise screw guidance, 360° expansion
	HH: Hexagonal head screw	

### Base material



Concrete (non-cracked)

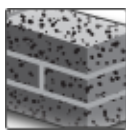

Solid brick

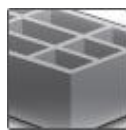

Hollow brick



Autoclaved aerated concrete



Drywall

### Basic loading data

#### All data in this section applies to:

- Correct setting (See setting instruction)
- Load data are only valid for the specified screw types
- No edge distance and spacing influence
- Base material as specified in the table
- Minimum base material thickness

### Anchorage depth

Anchor size		HMF 5x25	HMF 6x30	HMF 8x40	HMF 10x50	HMF 12x60	HMF 14x70
Nominal embedment depth	$h_{nom}$ [mm]	25	30	40	50	60	70

**Recommended loads <sup>a)</sup> for all load directions**

Anchor size		HMF 5x25	HMF 6x30	HMF 8x40	HMF 10x50	HMF 12x60	HMF 14x70
Screw type <sup>b)</sup>		CS F PH 4	CS 4,5 PH 4,5	CS 5 PH 5 HH 5	CS 7 PH 7 HH 7	HH 8	HH 10
<b>Non-cracked concrete</b> $\geq$ C16/20	$F_{Rec}$ [kN]	0,25	0,30	0,40	1,00	1,40	1,40
<b>Solid clay brick</b> size: 230x110x60 strength: $f_{c,test} \geq 20$ [N/mm <sup>2</sup> ] density: 2000 [kg/m <sup>3</sup> ]	$F_{Rec}$ [kN]	0,15	0,15	0,20	0,80	0,80	0,80
<b>Autoclaved aerated concrete AAC2</b> size: 600x175x200 strength: 2 [N/mm <sup>2</sup> ] density: 390[kg/m <sup>3</sup> ]	$F_{Rec}$ [kN]	0,02	0,04	0,05	0,10	0,15	0,15
<b>Autoclaved aerated concrete AAC4</b> size: 625x250x250 strength: 4,0 [N/mm <sup>2</sup> ] density: 600 [kg/m <sup>3</sup> ]	$F_{Rec}$ [kN]	0,04	0,06	0,10	0,18	0,18	0,22
<b>Hollow clay brick</b> type: Tramezza "Tavella" manufacturer: Fornace Tempora size: 200x250x30 strength: 25 [N/mm <sup>2</sup> ] density: 2000 [kg/m <sup>3</sup> ]	 $F_{Rec}$ [kN]	0,10	0,10	0,20	0,20	N/A <sup>c)</sup>	0,35
<b>Hollow clay brick</b> type: "Doppio Uni" manufacturer: Fornace S. Antonio size: 120x120x240 strength: 20 [N/mm <sup>2</sup> ] density: 2000 [kg/m <sup>3</sup> ]	 $F_{Rec}$ [kN]	0,10	0,10	0,15	0,25	0,45	0,45
<b>Hollow clay brick</b> type: Poroton "Blocchi portanti" manufacturer: Fornace S. Antonio size: 300x200x200 strength: 10 [N/mm <sup>2</sup> ] density: 2000 [kg/m <sup>3</sup> ]	 $F_{Rec}$ [kN]	0,10	0,10	0,10	0,20	0,20	0,20
<b>Hollow clay brick</b> type: Pignata "Blocchi intermedi" manufacturer: Fornace S. Antonio size: 120x120x240 strength: 25 [N/mm <sup>2</sup> ] density: 2000 [kg/m <sup>3</sup> ]	 $F_{Rec}$ [kN]	0,10	0,10	0,10	0,25	N/A <sup>c)</sup>	N/A <sup>c)</sup>
<b>Drywall</b> manufacturer: Knauf size: thickness 12,5 [mm] density: 680 [kg/m <sup>3</sup> ]	$F_{Rec}$ [kN]	0,02 <sup>d)</sup>	0,04	0,04	0,04	N/A <sup>c)</sup>	N/A <sup>c)</sup>
<b>Drywall with fibers</b> manufacturer: Knauf size: thickness 12,5 [mm] density: 1200 [kg/m <sup>3</sup> ]	$F_{Rec}$ [kN]	0,03	0,20	0,20	0,20	0,35	0,35

a) Performance assessment based on statistical evaluation of the ultimate loads, including the effect of drill bit wear, conditioning and different installation and in-service temperatures, load-displacement behaviour and scatter of the results. Based on that assessment a partial safety concept is used with  $\gamma_{M,concrete} = 1,8$ ;  $\gamma_{M,AAC} = 2,1$ ;  $\gamma_{M,masonry} = 2,5$  additional load safety factor of  $\gamma_{G,Q} = 1,4$ .

b) CS: Countersunk, PH: Pan head, HH hexagonal head; screws are specified by Hilti and can be ordered with the plastic body.

c) Not applicable

d) Shear load only

## Materials

### Material quality

Part	Material
Plastic sleeve	Polyamide 6
Screw	Carbon steel, galvanized $\geq 5 \mu\text{m}$

## Setting information

### Installation temperature

-10°C to +40°C

### In service temperature range

Hilti HMF universal plastic anchor may be applied in the temperature range given below.

### Temperature in base material

Temperature range	Base material temperature	Max. long term base material temperature	Max. short term base material temperature
Temperature range I	-40 °C to +80 °C	+50 °C	+80 °C

### Max short term base material temperature

Short-term elevated base material temperatures are those that occur over brief intervals, e.g. as a result of diurnal cycling.

### Max long term base material temperature

Long-term elevated base material temperatures are roughly constant over significant periods of time.

## Setting details

Anchor size	HMF 5x25		HMF 6x30		HMF 8x40		HMF 10x50		HMF 12x60		HMF 14x70	
	Screw type <sup>b)</sup>		CS 4 PH 4	CS 4,5 PH 4,5	CS 5 PH 5 HH 5	CS 7 PH 7 HH 7	HH 8	HH 10				
Nominal diameter of drill bit	$d_o$	[mm]	5	6	8	10	12	14				
Cutting diameter of drill bit	$d_{cut}$	[mm]	5,35	6,4	8,45	10,45	12,5	14,5				
Depth of drill hole	$h_1 \geq$	[mm]	35	40	50	70	80	90				
Nominal embedment depth	$h_{nom}$	[mm]	25	30	40	50	60	70				
Anchor length	$l_d$	[mm]	25	30	40	50	60	70				
Diameter of clearance hole in the fixture	$d_f \leq$	[mm]	5,5	6,5	8,5	11	13	15				
Length of the screw		[mm]	35	40	50	60	70	80				
Drive configuration			Pz2	Pz2	Pz2/T30	T30	T30	T30				
Hexhead diameter		[mm]	-	-	8	10	10	13				
Max fixture thickness	$t_{fix}$	[mm]	5	5	5	5	5	5				
Min. edge distance in concrete	$c_{min}$	[mm]	50	50	50	50	50	50				

b) CS: Countersunk, PH: Pan head, HH hexagonal head; screws are specified by Hilti and can be ordered with the plastic body.

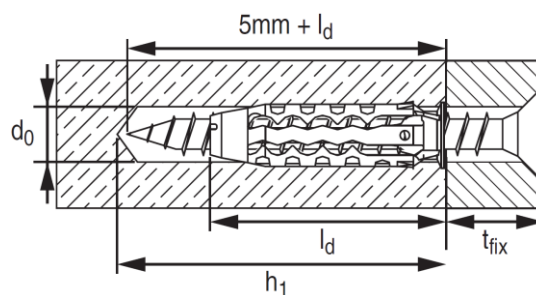

**Installation equipment**

Anchor size	HMF	5x25	6x30	8x40	10x50	12x60	14x70
Rotary hammer		TE 2- TE16					
Other tools		Screwdriver					

**Setting instruction**

\*For detailed information on installation see instruction for use given with the package of the product.

Setting instruction	
<b>1. Drill hole with drill bit</b> 	<b>2. Insert the anchor</b> 
<b>3. Drive screw into anchor</b> 	<b>4a. Drive screw into anchor in concrete</b> 
<b>4b. Drive screw into anchor in drywall</b> 	<b>4c. Drive screw into anchor in solid brick</b> 
<b>4d. Drive screw into anchor in hollow brick</b> 	

### 3.5.10 GD14+GRS

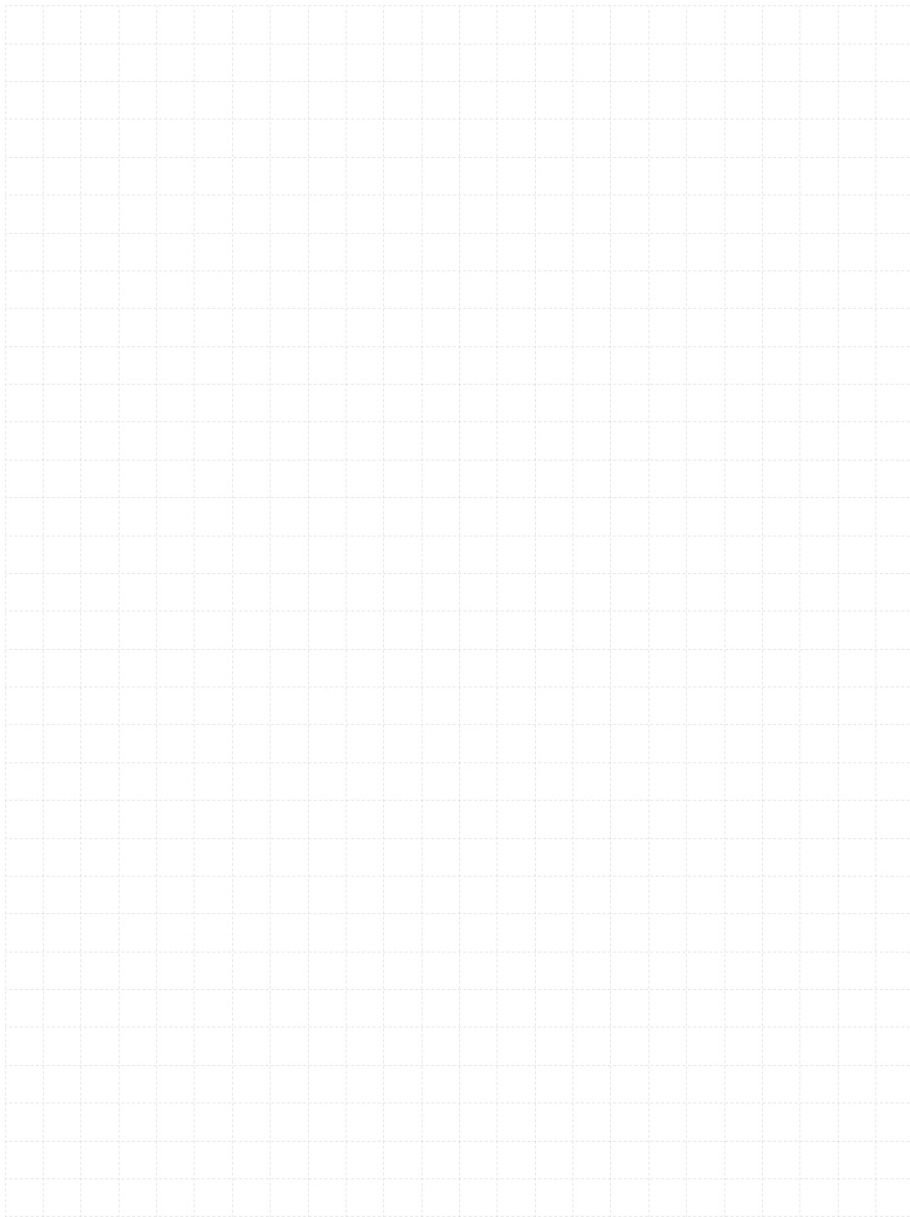
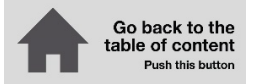

# GD 14 + GRS 12 Plastic anchors

## Economical plastic scaffolding anchor

### Anchor version



GD 14 (anchor body)  
GRS 12 (screw)  
(d14)

### Benefits

- Available in carbon steel and hot-dipped galvanized
- Integrated plastic and steel washer

### Base material



Concrete  
(non-cracked)

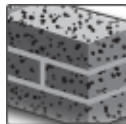

Solid brick

### Basic loading data

#### All data in this section applies to:

- Correct setting (See setting instruction)
- Load data are only valid for the specified screw
- No edge distance and spacing influence
- Minimum base material thickness

#### Anchorage depth

Anchor size		GD 14
Nominal embedment depth	$h_{nom} \geq$ [mm]	70

#### Design resistance <sup>a) b)</sup>

Anchor size		GD 14					
Screw type		GDS 12x90	GDS 12x120	GDS 12x160	GDS 12x190	GDS 12x230	GDS 12x350
Concrete C16/20 – C50/60	$N_{Rd}$ [kN]	4,2					
	$V_{Rd}$ [kN]	2,8	2,5	1,0	0,6	0,35	0,13
Solid clay brick Mz 12-2.0	$N_{Rd}$ [kN]	1,9					
	$V_{Rd}$ [kN]	1,0	1,0	1,0	0,6	0,35	0,13
Solid sand-lime brick KS 12-2.0	$N_{Rd}$ [kN]	1,3					
	$V_{Rd}$ [kN]	0,7	0,7	0,7	0,6	0,35	0,35

a) With partial safety factor  $\gamma = 1,8$  for concrete and  $\gamma = 2,5$  for masonry (acc. EAD 330284).

b) Shear load data are determined from the lower value of anchor load capacity in the base material and the serviceability load that ensures a maximum bending of the screw of 1/50 of its lever arm.

#### Recommended load <sup>a) b)</sup>

Anchor size		GD 14					
Screw type		GDS 12x90	GDS 12x120	GDS 12x160	GDS 12x190	GDS 12x230	GDS 12x350
Concrete C16/20 – C50/60	$N_{Rd}$ [kN]	2,8					
	$V_{Rd}$ [kN]	1,8	1,7	0,65	0,4	0,23	0,09
Solid clay brick Mz 12-2.0	$N_{Rd}$ [kN]	1,3					
	$V_{Rd}$ [kN]	0,65	0,65	0,65	0,4	0,23	0,09
Solid sand-lime brick KS 12-2.0	$N_{Rd}$ [kN]	0,85					
	$V_{Rd}$ [kN]	0,5	0,5	0,5	0,4	0,23	0,09

a) With partial safety factor  $\gamma = 1,8$  for concrete and  $\gamma = 2,5$  for masonry (acc. EAD 330284).

b) Shear load data are determined from the lower value of anchor load capacity in the base material and the serviceability load that ensures a maximum bending of the screw of 1/50 of its lever arm.

## Materials

### Material quality

Part	Material
Plastic sleeve	Polyamide

## Setting information

### Installation temperature

-10°C to +40°C

### Service temperature range

Hilti GD frame anchors may be applied in the temperature range given below.

Temperature range	Base material temperature	Max. long term base material temperature	Max. short term base material temperature
Temperature range	-40 °C to +80 °C	+50 °C	+80 °C

### Max short term base material temperature

Short-term elevated base material temperatures are those that occur over brief intervals, e.g. as a result of diurnal cycling.

### Max long term base material temperature

Long-term elevated base material temperatures are roughly constant over significant periods of time.

## Setting details

Anchor size	GD 14		
Drill hole diameter	$d_o$	[mm]	14
Cutting diameter of drill bit	$d_{cut} \leq$	[mm]	14,5
Depth of drilled hole to deepest point	$h_1 \geq$	[mm]	90
Overall plastic anchor embedment depth in base material	$h_{nom} \geq$	[mm]	70
Recommended length of screw in base material	$l_d$	[mm]	75

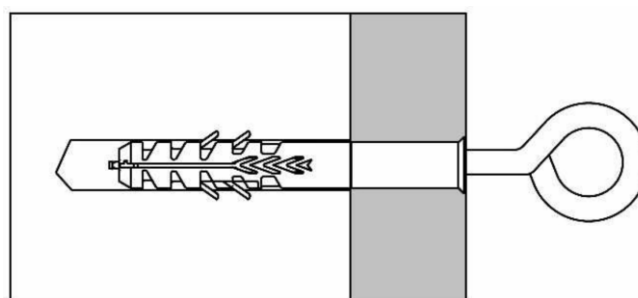



## Installation equipment

Anchor size	GD 14
Rotary hammer	TE 2- TE16
Other tools	blow out pump

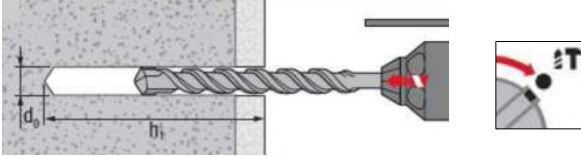

## Setting instruction

\*For detailed information on installation see instruction for use given with the package of the product.

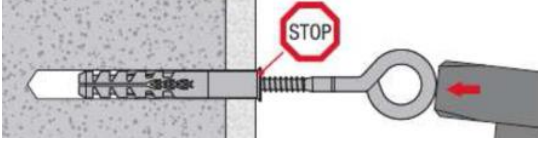
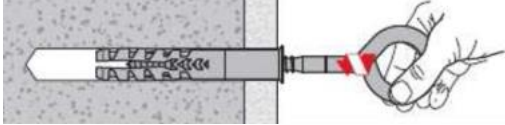
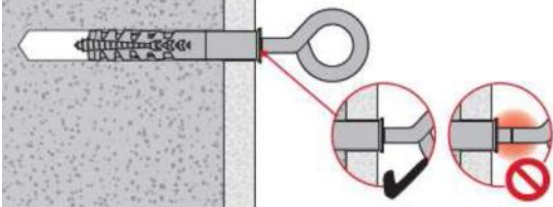
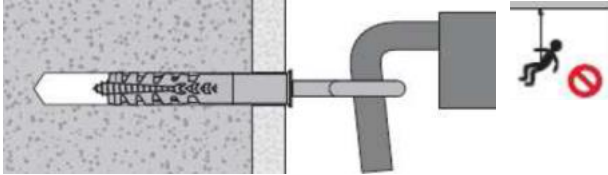
Setting instruction for GD 14 + GRS 12	
<b>1. Drilling</b> 	<b>2. Cleaning</b> 
<b>3. Inserting the anchor with hammer</b> 	<b>4. Inserting the anchor with hand</b> 
<b>5. Checking</b> 	<b>6. Loading the anchor</b> 

Use only for fixing scaffolds wall and floor applications. Not applicable for ceiling and façade applications.



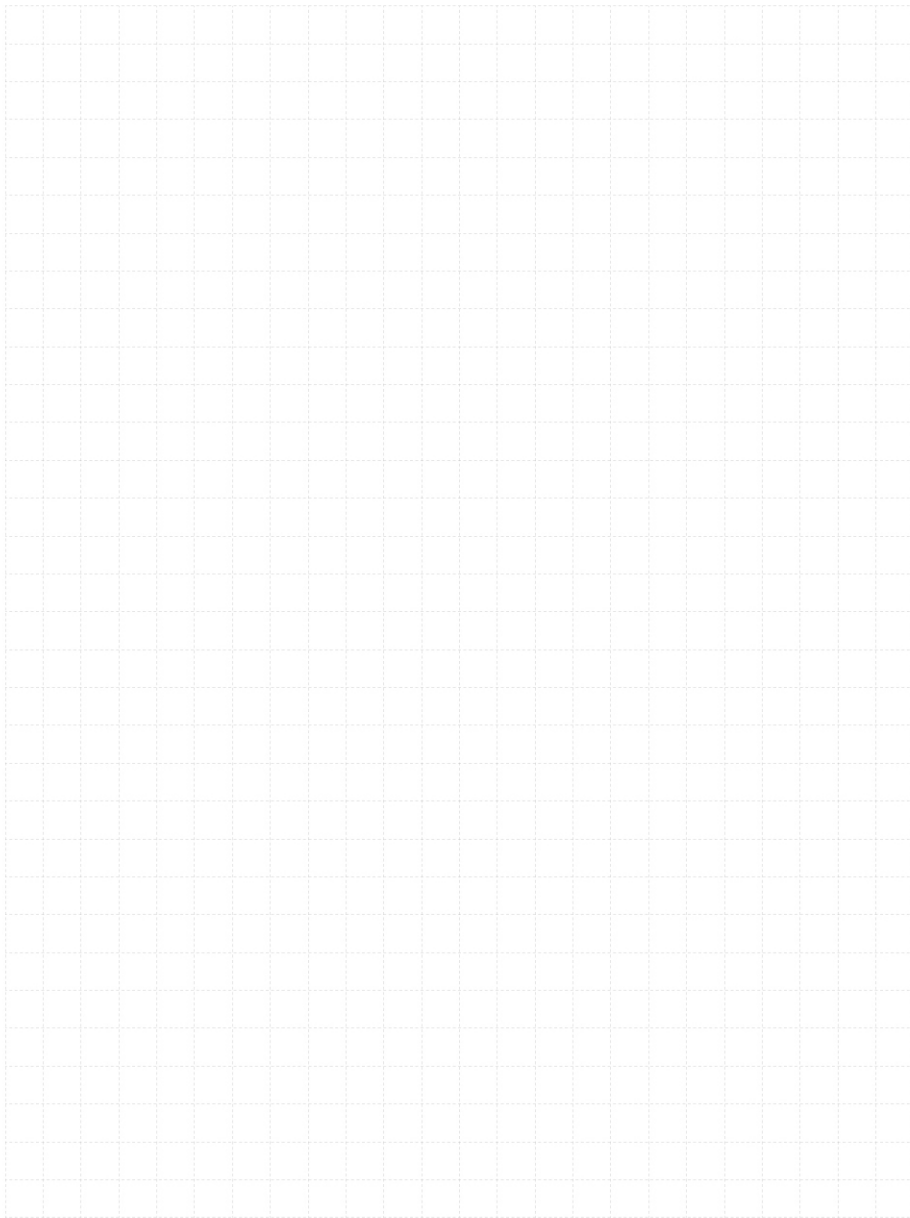
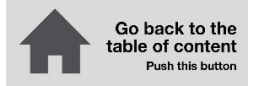

## 3.6 Light duty anchors







### 3.6.1 HFB

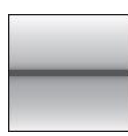

# HFB Nail anchor

## Premium Fastener for Fire Protection Panels, Light Duty applications and Light Ventilated Facades

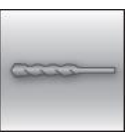
Anchor version	Benefits
 HFB (d6)	<ul style="list-style-type: none"> <li>- Verified for ISO 834 (celluloid) curve, HCM curve, ZTV-ING part 5 curve and RWS fire curve.</li> <li>- System tests with several market leading Boards</li> <li>- Keeps its place under static, dynamic and seismic (C1) conditions thereby minimizing economical impact.</li> <li>- Comes with a cordless electric power tool for drilling, setting and removal allowing the fastest (re-) installation time, ensuring that the service interruption is minimized.</li> <li>- The anchor can easily be removed, even the "nail head" geometry"</li> <li>- Pre-assembled washer</li> <li>- Mesh clip for a quick and easy installation support when used with sprayed fire protection mortar</li> <li>- Pre-assembled rubber washer, ideal for installation of light ventilated façade brakckets</li> </ul>
 HFB-R (d6) HFB-HCR (d6)	
 HFB-A-R (M6) HFB-A-HCR (M6)	
 HFB-R RW (d6)	

Base material	Load conditions
 Concrete (cracked)	 Static/ quasi-static
	 Seismic C1
	 Fire resistance
	 Fatigue/Dynamic
Installation conditions	Other information
 Hammer drilled holes	 European Technical Assessment
	 CE conformity

### Approvals / certificates

Description	Authority / Laboratory	No. / date of issue
European technical assessment <sup>a)</sup>	ZAG. Ljubljana	ETA-17/0168, 2021-01-18
Fire test report <sup>a)</sup>	ZAG. Ljubljana	ETA-17/0168, 2021-01-18
Fire test report (RWS/HCinc)	EFFECTIS France	EFR-18-J-002325
Seismic report	Fastening-technology	TA-1703, 2018-05-25
Fatigue	Hilti technical data	TA

a) All data given in this section according to ETA-17/0168, issue 2021-01-18.

**Static and quasi-static loading (for a single anchor)**
**All data in this section applies to:**

- Correct setting (See setting instruction)
- No edge distance and spacing influence
- Steel failure
- Minimum base material thickness
- Concrete C 20/25,  $f_{ck,cube} = 25 \text{ N/mm}^2$

**Effective anchorage depth for static**

Anchor size		M6 / d6		
Effective anchorage depth	$h_{ef}$ [mm]	25	30	35 <sup>a)</sup>

**Characteristic resistance**

Anchor size		M6 / d6			
<b>Cracked concrete</b>					
Resistance, load in all directions	HFB-R, HFB-R RW, HFB-HCR, HFB-A-HCR	$F_{0Rk}$ [kN]	3,0	5,0	6,0
	HFB, HFB-A-R;		3,0	4,5	6,0 <sup>a)</sup>

**Design resistance**

Anchor size		M6 / d6			
<b>Cracked concrete</b>					
Resistance, load in all directions	HFB-R, HFB-R RW, HFB-HCR, HFB-A-HCR	$F_{0Rd}$ [kN]	2,0	3,3	4,0
	HFB, HFB-A-R		2,0	3,0	4,0 <sup>a)</sup>

**Recommended<sup>b)</sup> resistance**

Anchor size		M6 / d6			
<b>Cracked concrete</b>					
Resistance, load in all directions	HFB-R, HFB-R RW, HFB-HCR, HFB-A-HCR	$F_{0Rec}$ [kN]	1,4	2,4	2,9
	HFB, HFB-A-R		1,4	2,1	2,9 <sup>a)</sup>

a) Not applicable to HFB (CS), since it is not tested for  $h_{ef}=35$ .

b) With overall partial safety factor for action  $\gamma = 1,4$ , The partial safety factors for action depend on the type of loading and shall be taken from national regulations.

**Seismic loading (for a single anchor)**
**All data in this section applies to:**

- Correct setting (See setting instruction)
- No edge distance and spacing influence
- Steel failure
- Minimum base material thickness
- Concrete C 20/25,  $f_{ck,cube} = 25 \text{ N/mm}^2$
- All data given in this section is according to TA-1703, issue 2018-05-25

**Effective anchorage depth for seismic C1**

Anchor size		M6 / d6		
Effective anchorage depth	$h_{ef}$ [mm]	25	30	35

**Characteristic resistance in case of seismic performance C1**

Anchor size		M6 / d6			
Cracked concrete					
Tension	HFB-R, HFB-R RW	$N_{Rk,seis}$ [kN]	3,0	4,0	4,0
	HFB-A-R		3,0	4,0	4,0
Shear	HFB-R, HFB-R RW	$V_{Rk,seis}$ [kN]	-	3,5	3,5
	HFB-A-R		-	-	-

**Design resistance in case of seismic performance C1**

Anchor size		M6 / d6			
Cracked concrete					
Tension	HFB-R, HFB-R RW	$N_{Rd,seis}$ [kN]	2,0	2,6	2,6
	HFB-A-R		2,0	2,6	2,6
Shear	HFB-R, HFB-R RW	$V_{Rd,seis}$ [kN]	-	2,3	2,3
	HFB-A-R		-	-	-

## Fire resistance

### All data in this section applies to:

- Correct setting (See setting instruction)
- No edge distance and spacing influence
- Steel failure
- Minimum base material thickness
- Concrete C 20/25 to C50/60
- Partial safety factor for resistance under fire exposure  $\gamma_{M,fi} = 1,0$  (in absence of other national regulations)

### Effective anchorage depth

Anchor size		M6 / d6		
Effective anchorage depth	$h_{ef}$ [mm]	25	30	35 <sup>a)</sup>

a) Not applicable to HFB (CS), since it is not tested for  $h_{ef}=35$ .

### Characteristic resistance

Anchor size		M6 / d6			
<b>Fire exposure R30</b>					
Resistance, load in all directions	HFB	$F^{0}_{Rk,fi}$ [kN]	0,5	0,9	- a)
	HFB-R, HFB-HCR, HFB-R RW		0,5	0,9	1,2
	HFB-A-R, HFB-A-HCR		0,5	0,9	1,0
<b>Fire exposure R120</b>					
Resistance, load in all directions	HFB	$F^{0}_{Rk,fi}$ [kN]	0,3	0,3	- a)
	HFB-R, HFB-HCR, HFB-R RW		0,2	0,7	1,0
	HFB-A-R, HFB-A-HCR		0,1	0,1	0,1

### Design resistance

Anchor size		M6 / d6			
<b>Fire exposure R30</b>					
Resistance, load in all directions	HFB	$F^{0}_{Rd,fi}$ [kN]	0,5	0,9	- a)
	HFB-R, HFB-HCR, HFB-R RW		0,5	0,9	1,2
	HFB-A-R, HFB-A-HCR		0,5	0,9	1,0
<b>Fire exposure R120</b>					
Resistance, load in all directions	HFB	$F^{0}_{Rd,fi}$ [kN]	0,3	0,3	- a)
	HFB-R, HFB-HCR, HFB-R RW		0,2	0,7	1,0
	HFB-A-R, HFB-A-HCR		0,1	0,1	0,1

For more information about different failure modes and fire resistance times please see the full ETA-17/0168 report.

**Materials**
**Material quality**

Part		Material
<b>Metal parts made of carbon steel</b>		
Anchor bolt	HFB	Carbon steel, galvanized, coated, rupture elongation ( $l_0 = 5d$ ) > 8%
Expansion sleeve	HFB	Stainless steel A4
<b>Metal parts made of stainless steel</b>		
Anchor bolt	HFB-R, HFB-A-R, HFB-R RW	Stainless steel A4, coated, rupture elongation ( $l_0 = 5d$ ) > 8%
Expansion sleeve	HFB-R, HFB-A-R, HFB-R RW	Stainless steel A4
Washer	HFB-R, HFB-A-R, HFB-R RW	Stainless steel A4
Hexagon/Special nut	HFB-R, HFB-A-R, HFB-R RW	Stainless steel A4
<b>Metal parts made of high corrosion resistant steel</b>		
Anchor bolt	HFB-HCR HFB-A-HCR	High corrosion resistance steel, coated, rupture elongation ( $l_0 = 5d$ ) > 8%
Expansion sleeve	HFB-HCR HFB-A-HCR	High corrosion resistance steel
Washer	HFB-HCR HFB-A-HCR	High corrosion resistance steel
Hexagon/Special nut	HFB-HCR HFB-A-HCR	High corrosion resistance steel
<b>Rubber parts</b>		
Washer	HFB-R RW	Elastomer, black

**Anchor dimensions**

Anchor		HFB	HFB-R, HFB-R RW, HFB-HCR	HFB-A-R and HFB-A-HCR
Maximum length of anchor	$l_{max} \leq$ [mm]	150		
Anchor diameter	$d_1$ [mm]	5,9	5,2	
Shaft diameter at the cone	$d_R$ [mm]	4,2		
Diameter of head	$d_H \leq$ [mm]	12,2	-	
Length of expansion sleeve	$l_s$ [mm]	10,1		
Diameter of washer	$d_w \leq$ [mm]	-	30	
Thickness of washer	$h_w \leq$ [mm]	-	1,5	

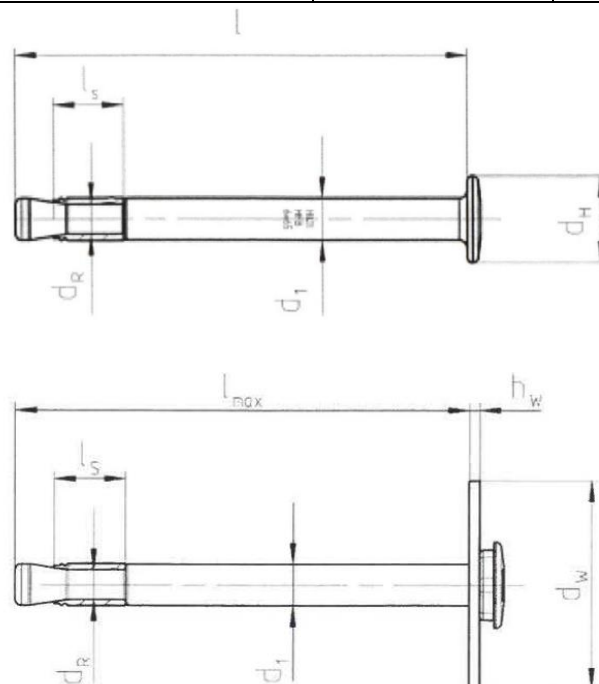

**Setting information**
**Setting details**

Anchor		HFB, HFB-R, HFB-R RW HFB-A-R, HFB-HCR and HFB-A-HCR		
Nominal diameter of drill bit	$d_o$ [mm]	6		
Cutting diameter of drill bit	$d_{cut} \leq$ [mm]	6,40		
Maximum diameter of clearance hole in the fixture	$d_f$ [mm]	7		
Nominal embedment depth	$h_{nom}$ [mm]	30	35	40 <sup>a)</sup>
Effective embedment depth	$h_{ef}$ [mm]	25	30	35 <sup>a)</sup>
Drill hole depth	$h_1 \geq$ [mm]	34	39	44 <sup>a)</sup>

a) Not applicable to HFB (CS), since it is not tested for  $h_{ef}=35$ .

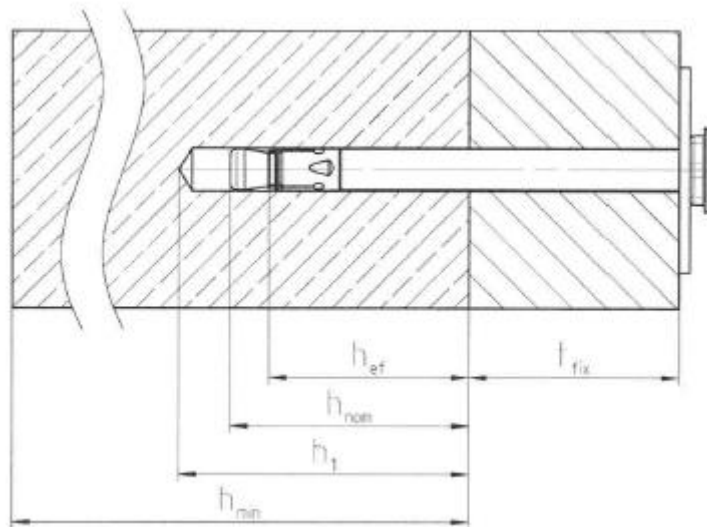
**Setting parameters**

Anchor Size		HFB, HFB-R, HFB-R RW, HFB-A-R, HFB-HCR and HFB-A-HCR		
Effective anchorage depth	$h_{ef}$ [mm]	25	30	35 <sup>a)</sup>
Minimum base material thickness	$h_{min}$ [mm]	80	80	80 <sup>a)</sup>
Minimum spacing	$s_{min}$ [mm]	50	50	50 <sup>a)</sup>
	for $c \geq$ [mm]	50	50	50 <sup>a)</sup>
Minimum edge distance	$c_{min}$ [mm]	40	40	40 <sup>a)</sup>
	for $s \geq$ [mm]	75	80	80 <sup>a)</sup>

a) Not applicable to HFB (CS), since it is not tested for  $h_{ef}=35$ .

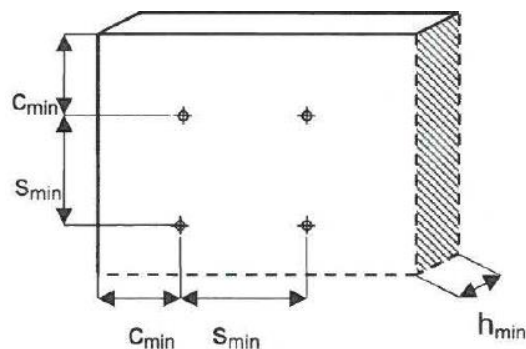



### Installation equipment

Anchor size	HFB	HFB-R, HFB-R RW	HFB-A-R	HFB-HCR	HFB-A-HCR
Rotary hammer	TE-4 (-A) – TE-6 (-A)				
Setting tool	TE-C-HFB-ST				
Setting tool pneumatic	P-HFB-ST				
Setting tube	D-HFB-ST				
Socket wrench	-	-	SI-HFB-RS	-	SI-HFB-RS
Mesh clip	-	HFB-CM 20	HFB-CM 20	-	-

### Applications



**Fastening of pre-fabricated fire protection boards**



**Fastening of light wire mesh reinforcement for fire protection mortar**

## Setting instructions

\*For detailed information on installation see instruction for use given with the package of the product

### Setting instruction for HFB-R, HFB-R RW\* , HFB-A-R, HFB-HCR and HFB-A-HCR

#### Hammer drilling

##### 1. Drill the hole

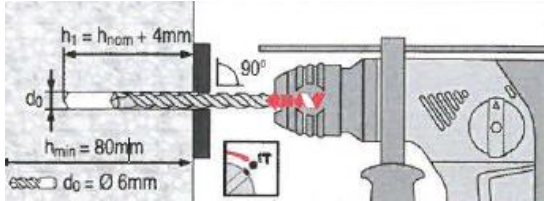

##### 2. Clean the hole

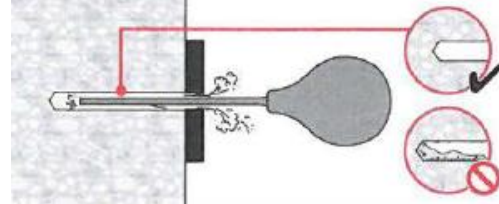

##### 3a. Insert the anchor with hammer

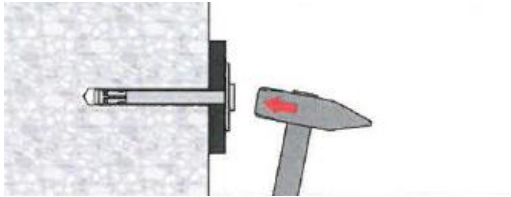

##### 3b. Insert the anchor with setting tool TE-C-HFB-ST

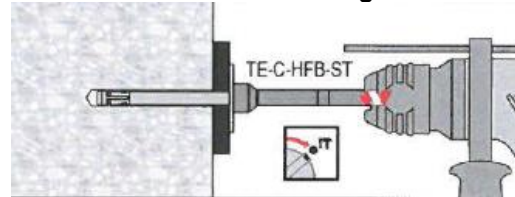

##### 3c. Insert the anchor with setting tool D-HFB-ST

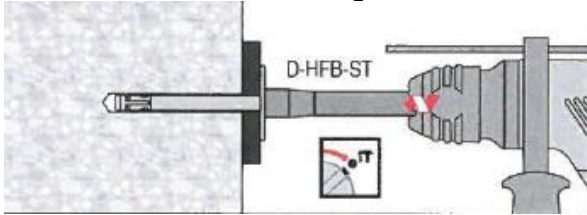

##### 3d. Insert the anchor with setting tool P-HFB-ST

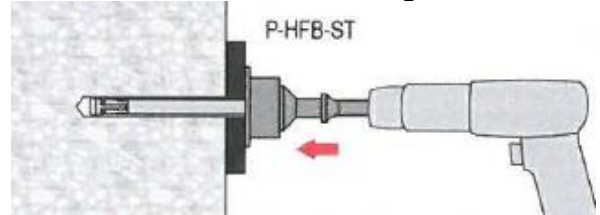

##### 4. Check the anchor

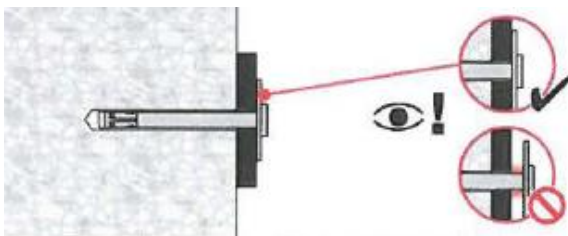

### 3.6.2 DBZ

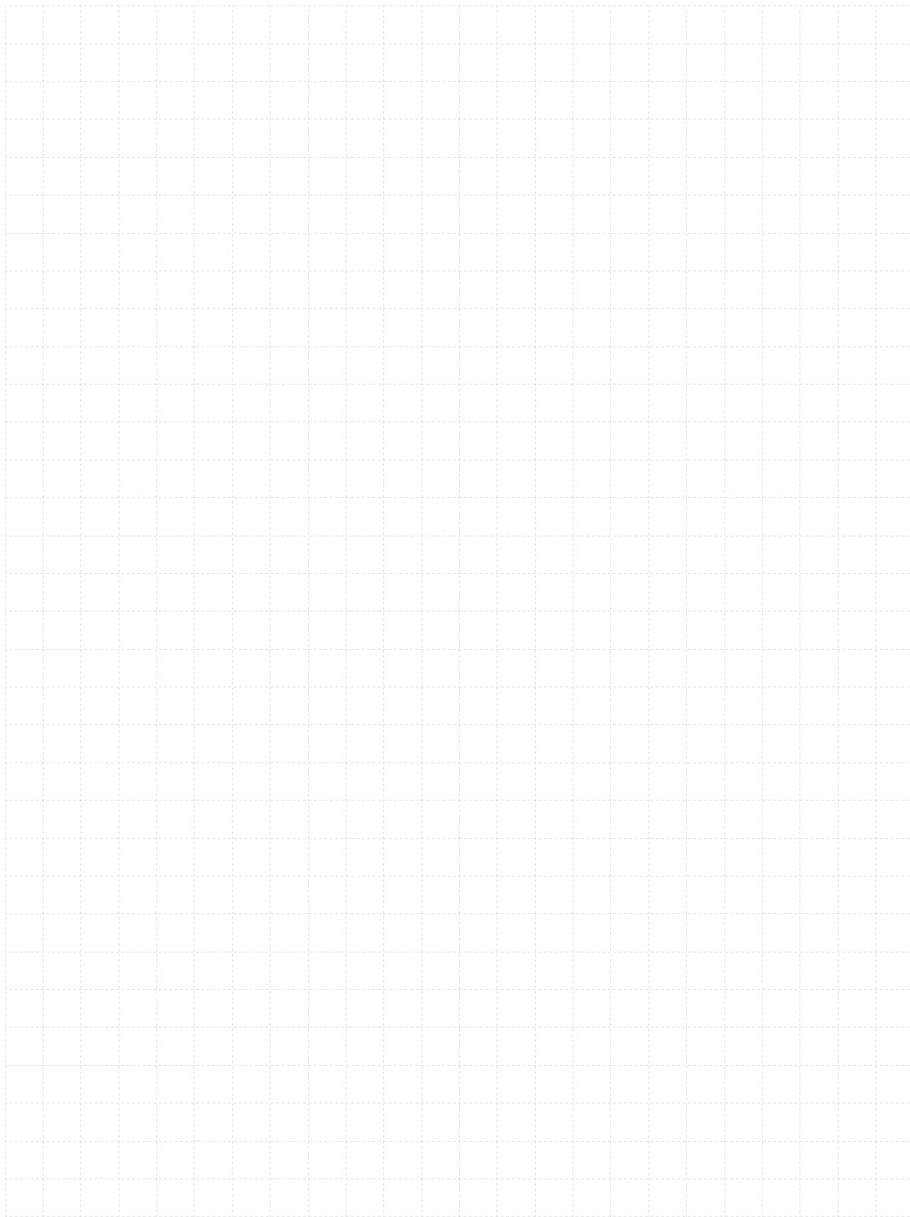

# DBZ Light duty metal anchors

## Economical wedge anchor

### Anchor version



DBZ  
(d6)

### Benefits

- Well proven
- Simple installation
- Small drill bit diameter
- Suitable for cracked and non-cracked concrete C20/25 to C50/60
- Redundant fastening only, e.g. suspended ceilings

### Base material

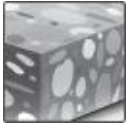

Concrete  
(non-cracked)

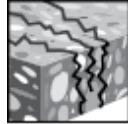

Concrete  
(cracked)

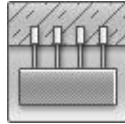

Redundant  
fastening

### Load conditions

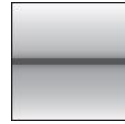

Static /  
quasi-static



Fire  
resistance

### Other information



European  
Technical  
Assessment



CE conformity

### Approvals / certificates

Description	Authority / Laboratory	No. / date of issue
European Technical Assessment <sup>a)</sup>	DIBt, Berlin	ETA-06/0179 / 2022-12-12
Fire test report	DIBt, Berlin	ETA-06/0179 / 2022-12-12

a) All data given in this section according ETA-06/0179, issue 2022-12-12. The anchor is to be used only for redundant fastening for non-structural applications.

### Static and quasi-static loading (for a single anchor)

#### All data in this section applies to:

- Correct setting (See setting instruction)
- No edge distance and spacing influence
- Concrete C20/25 to C50/60
- Anchors in redundant fastening

#### Anchorage depth

Anchor size		DBZ 6 / 4,5	DBZ 6 / 35
Resistance, all load directions	$h_{ef} \geq$ [kN]	32	

#### Characteristic resistance

Anchor size		DBZ 6 / 4,5	DBZ 6 / 35
Resistance, all load directions	$F_{Rk}$ [kN]	5,0	

#### Design resistance

Anchor size		DBZ 6 / 4,5	DBZ 6 / 35
Resistance, all load directions	$F_{Rd}$ [kN]	3,3	

#### Recommended loads <sup>a)</sup>

Anchor size		DBZ 6 / 4,5	DBZ 6 / 35
Resistance, all load directions	$F_{Rec}$ [kN]	2,4	

- a) With overall partial safety factor for action  $\gamma = 1,4$ . The partial safety factors for action depend on the type of loading and shall be taken from national regulations.

### Fire resistance

#### All data in this section applies to:

- Correct setting (See setting instruction)
- No edge distance and spacing influence
- Steel failure
- Minimum base material thickness
- Concrete C 20/25,  $f_{ck,cyl} = 20$  N/mm<sup>2</sup> (EN 1992-4 design)
- partial safety factor for resistance under fire exposure  $\gamma_{M,fi}=1,0$  (in absence of other national regulations)

#### Anchorage depth

Anchor size		DBZ 6 / 4,5	DBZ 6 / 35
Resistance, all load directions	$h_{ef} \geq$ [kN]	32	

#### Characteristic resistance

Anchor size		DBZ 6 / 4,5	DBZ 6 / 35
<b>Fire exposure R30</b>			
Resistance, all load directions	$F_{Rk,fi}$ [kN]	0,6	
<b>Fire exposure R120</b>			
Resistance, all load directions	$F_{Rk,fi}$ [kN]	0,2	

#### Design resistance

Anchor size		DBZ 6 / 4,5	DBZ 6 / 35
<b>Fire exposure R30</b>			
Resistance, all load directions	$F_{Rd,fi}$ [kN]	0,6	
<b>Fire exposure R120</b>			
Resistance, all load directions	$F_{Rd,fi}$ [kN]	0,2	

For more information about different failure modes and fire resistance times please see the full ETA-06/0179 report.

The definition of redundant fastening according to Member States is given in the EN 1992-4 and CEN/TR 17079. In Absence of a definition by a Member States the following default values may be taken.

Minimum number of fixing points	Minimum number of anchors per fixing point	Maximum design load of action $N_{Sd}$ per fixing point <sup>a)</sup>
3	1	2 kN
4	1	3 kN

- a) The value for maximum design load of actions per fastening point  $N_{Sd}$  is valid in general that means all fastening points are considered in the design of the redundant structural system. The value  $N_{Sd}$  may be increased if the failure of one (=most unfavourable) fixing point is taken into account in the design (serviceability and ultimate limit state) of the structural system e.g. suspended ceiling.

## Materials

### Mechanical properties

Anchor size		DBZ 6 / 4,5	DBZ 6 / 35
Nominal tensile strength	$f_{uk}$ [N/mm <sup>2</sup> ]	390	390
Yield strength	$f_{yk}$ [N/mm <sup>2</sup> ]	310	310
Stressed cross-section	$A_s$ [mm <sup>2</sup> ]	26	26
Characteristic bending resistance	$M^0_{Rk,s}$ [Nm]	5,0	5,0

5

### Material quality

Part	Material
Anchor shank (1)	Cold-formed steel, galvanized $\geq 5\mu\text{m}$
Expansion pin (2)	Cold-formed steel, galvanized $\geq 5\mu\text{m}$

### Anchor dimension

Anchor size		DBZ 6 / 4,5	DBZ 6 / 35
Height anchor head	$l_1$ [mm]	2,5	2,5
Max. distance	$d_1$ [mm]	6,4	6,4
Length of anchor shaft	$l_2$ [mm]	37,5	68

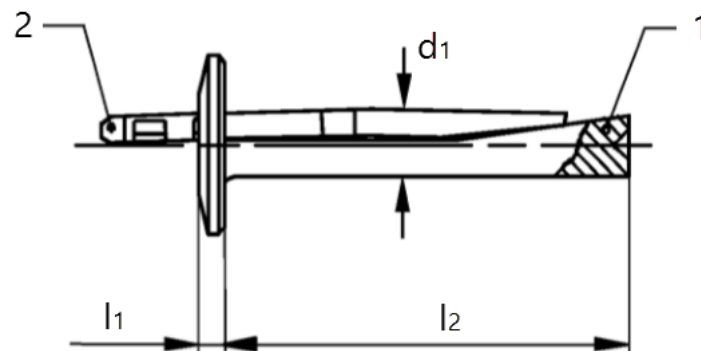



**Setting information**
**Setting details**

Anchor size		DBZ 6 / 4,5	DBZ 6 / 35	
Thickness of fixture	$t_{fix}$ [mm]	$\leq 4,5$	$20 \leq t_{fix} \leq 35$	$5 \leq t_{fix} \leq 20$
Depth of drill hole	$h_1 \geq$ [mm]	40	55	70
Cutting diameter of drill bit	$d_{cut} \leq$ [mm]	6,4		
Nominal diameter of drill bit	$d_0$ [mm]	6		
Clearance hole diameter	$d_r \leq$ [mm]	7		

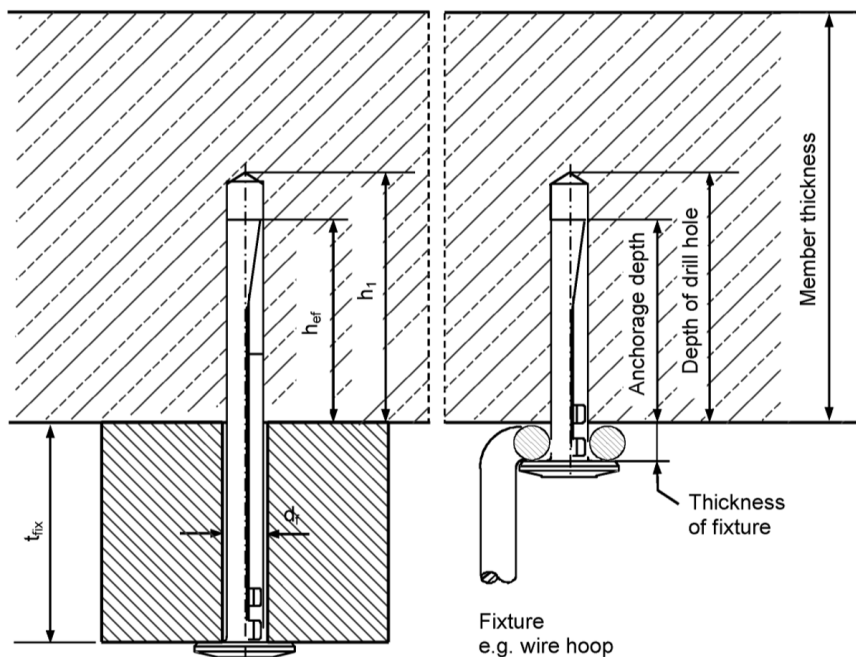

**Installation equipment**

Anchor size	DBZ 6 / 4,5	DBZ 6 / 35
Rotary hammer	TE 2 - TE 7	
Other tools	Hammer, blow out pump	

**Setting parameters**

Anchor size		DBZ 6 / 4,5	DBZ 6 / 35	
Thickness of fixture	$t_{fix}$ [mm]	$\leq 4,5$	$20 \leq t_{fix} \leq 35$	$5 \leq t_{fix} \leq 20$
Minimum member thickness	$h_{min} \geq$ [mm]	80	100	
Effective anchorage length	$h_{ef} \geq$ [mm]	32		
Minimum spacing	$s_{min} = s_{cr}$ [mm]	200		
Minimum edge distance	$c_{min} = c_{cr}$ [mm]	150		

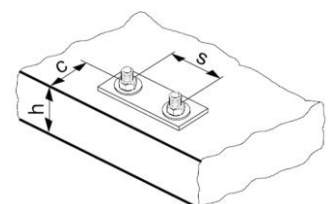
- a) The critical spacing (critical edge distance) shall be kept. Smaller spacing (edge distance) than critical spacing (critical edge distance) are not covered by the design method.



### Setting instruction

\*For detailed information on installation see instruction for use given with the package of the product.

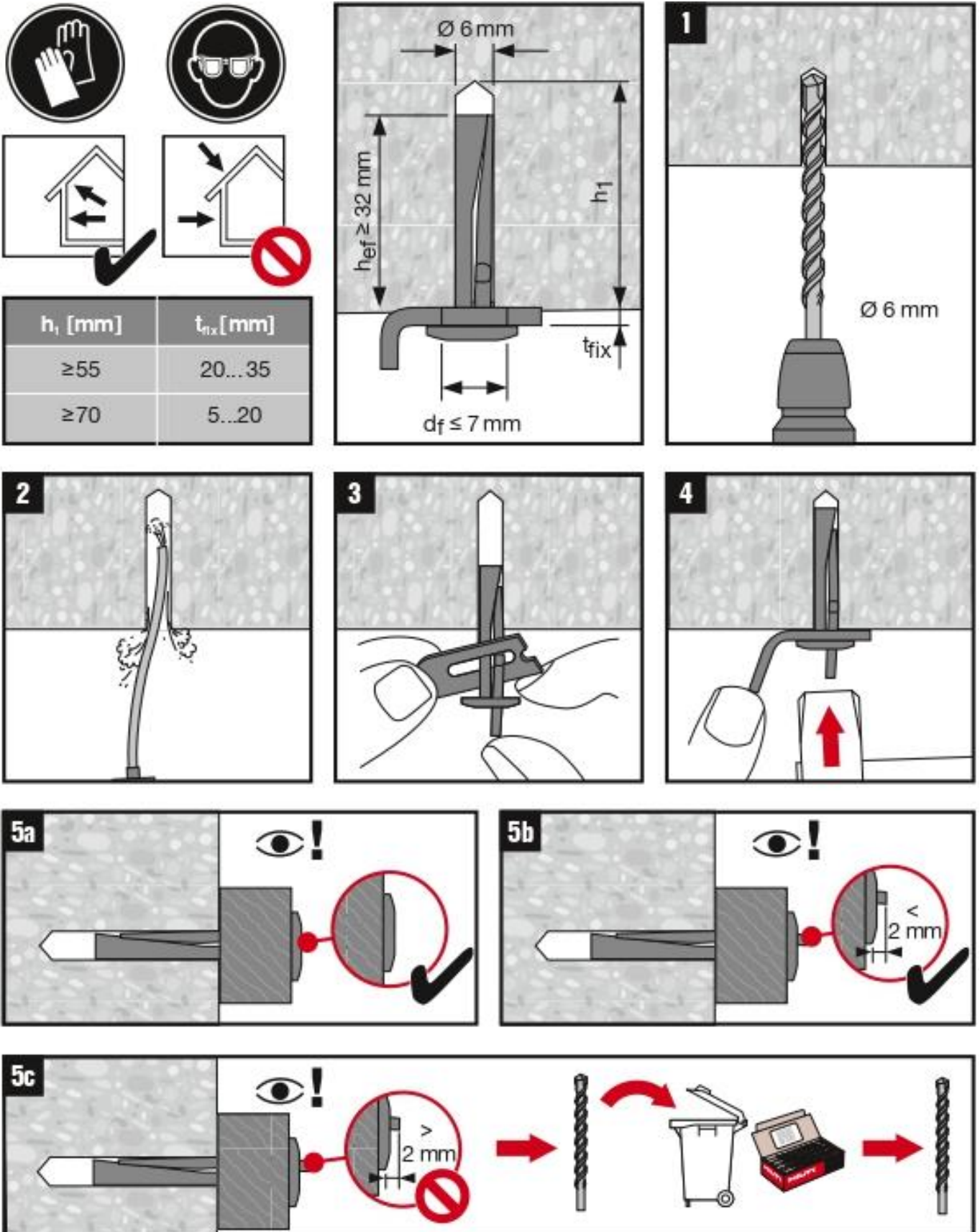



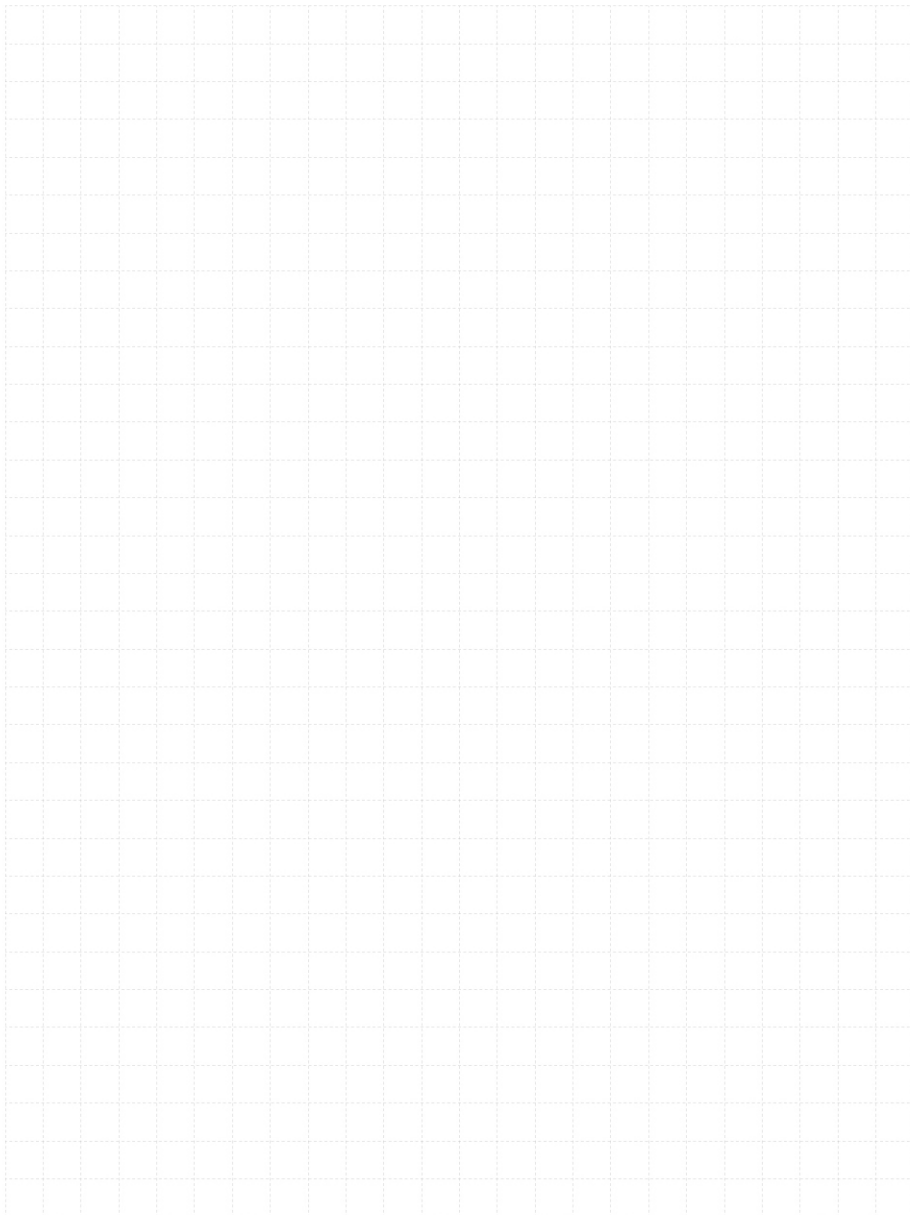

### 3.6.3 HK



# HK Light duty metal anchors

## Everyday standard ceiling anchor

Anchor version		Benefits
	HK (M6-M8)	<ul style="list-style-type: none"> <li>- Well proven</li> <li>- Small drill bit diameter</li> <li>- For fixing in cracked concrete, redundant fastening only, e.g. suspended ceilings</li> </ul>
	HK I (M6-M8)	
	HK L (M6-M8)	

Base material	Load conditions
 <p>Concrete (non-cracked)</p>  <p>Tensile zone (redundant fastening)</p>  <p>Redundant fastening</p>	 <p>Fire resistance</p>

Other information
 <p>European Technical Approval</p>  <p>CE conformity</p>

### Approvals / certificates

Description	Authority / Laboratory	No. / date of issue
European technical assesment <sup>a)</sup>	DIBt, Berlin	ETA-04/0043, 2018-04-25
Fire test report	DIBt, Berlin	ETA-04/0043, 2018-04-25
Assessment fire report	warringtonfire	WF 327804/A / 2013-07-10

a) All data given in this section for HK Ceiling anchor according ETA-04/0043, issue 2018-04-25. The anchor is to be used only for multiple use for non-structural applications.

**Basic loading data (for a single anchor)**
**All data in this section applies to:**

- Correct setting (See setting instruction)
- No edge distance and spacing influence
- Concrete C20/25 to C50/60
- Non-cracked concrete:  $f_{ck,cube} \geq 25 \text{ N/mm}^2$
- Anchors in multiple use

**Anchorage depth**

Anchor size (Carbon steel)		HK6 / HK6-R / HK6-HCR	HK6 L / HK6L-R / HK6L-HCR	HK8 / HK8-R / HK8-HCR
Effective anchorage depth	$h_{ef} \geq$ [kN]	26	36	36

**Characteristic resistance**

Anchor size (Carbon steel)		HK6	HK6 L	HK8 I
Resistance	$F_{Rk}^{a)}$ [kN]	2,0	5,0	5,0
Anchor size (Stainless steel, HCR)		HK6 -R / -HCR	HK6 L -R / -HCR	HK8 I -R / -HCR
Resistance	$F_{Rk}^{a)}$ [kN]	1,5	3,0	5,0

a) For all load directions (tension, shear and combined tension and shear loads)

**Design resistance**

Anchor size (Carbon steel)		HK6	HK6 L	HK8 I
Resistance	$F_{Rd}^{a)}$ [kN]	1,3	2,4	2,4
Anchor size (Stainless steel, HCR)		HK6 -R / -HCR	HK6 L -R / -HCR	HK8 I -R / -HCR
Resistance	$F_{Rd}^{a)}$ [kN]	0,7	1,4	2,8

a) For all load directions (tension, shear and combined tension and shear loads)

**Recommended loads<sup>b)</sup>**

Anchor size (Carbon steel)		HK6	HK6 L	HK8 I
Resistance	$F_{Rec}^{a)}$ [kN]	0,9	1,7	1,7
Anchor size (Stainless steel, HCR)		HK6 -R / -HCR	HK6 L -R / -HCR	HK8 I -R / -HCR
Resistance	$F_{Rec}^{a)}$ [kN]	0,5	1,0	2,0

a) For all load directions (tension, shear and combined tension and shear loads)

b) With overall partial safety factor for action  $\gamma = 1,4$ . The partial safety factors for action depend on the type of loading and shall be taken from national regulations.

**Requirements for multiple use**

The definition of multiple use according to Member State is given in EN 1992-4 and CEN/TR 17079. In Absence of a definition by a Member State the following default values may be taken.

Minimum number of fixing points	Minimum number of anchors per fixing point	Maximum design load of action $N_{sd}$ per fixing point <sup>a)</sup>
3	1	2 kN
4	1	3 kN

## Fire resistance

### All data in this section applies to:

- Correct setting (See setting instruction)
- No edge distance and spacing influence
- Steel failure
- Minimum base material thickness
- Concrete C 20/25,  $f_{ck,cyl} = 20 \text{ N/mm}^2$  (EN 1992-4 design)
- partial safety factor for resistance under fire exposure  $\gamma_{M,fi}=1,0$  (in absence of other national regulations)

### Anchorage depth

Anchor size (Carbon steel)		HK6 / HK6-R / HK6-HCR	HK6 L / HK6L-R / HK6L-HCR	HK8 / HK8-R / HK8-HCR
Effective anchorage depth	$h_{ef} \geq$ [kN]	26	36	36

### Characteristic resistance

Anchor size (Carbon steel)		HK6 / HK6-R / HK6-HCR	HK6 L / HK6L-R / HK6L-HCR	HK8 / HK8-R / HK8-HCR
<b>Fire exposure R30</b>				
Resistance	$F_{Rk,fi}^{a)}$ [kN]	0,3	0,6	1,2
<b>Fire exposure R120</b>				
Resistance	$F_{Rk,fi}^{a)}$ [kN]	0,2	0,2	0,4

a) For all load directions (tension, shear and combined tension and shear loads)

### Design resistance

Anchor size (Carbon steel)		HK6 / HK6-R / HK6-HCR	HK6 L / HK6L-R / HK6L-HCR	HK8 / HK8-R / HK8-HCR
<b>Fire exposure R30</b>				
Resistance	$F_{Rd,fi}^{a)}$ [kN]	0,3	0,6	1,2
<b>Fire exposure R120</b>				
Resistance	$F_{Rd,fi}^{a)}$ [kN]	0,2	0,2	0,4

a) For all load directions (tension, shear and combined tension and shear loads)

For more information about different failure modes and fire resistance times please see the full ETA-04/0043 report.

### Requirements for multiple use

The definition of multiple use according to Member State is given in EN 1992-4 and CEN/TR 17079. In Absence of a definition by a Member State the following default values may be taken.

Minimum number of fixing points	Minimum number of anchors per fixing point	Maximum design load of action $N_{Sd}$ per fixing point <sup>a)</sup>
3	1	2 kN
4	1	3 kN

**Special case: Groups of n=2 and /or n=4 anchors with small spacing:**

The basic loading data for a single anchor is valid for one fixing point.

Fixing point can be:

- **Single anchors**
- **Groups of 2 anchors**  
With  $s_1 \geq 60\text{mm}$
- **Groups of 4 anchors**  
With  $s_1 \geq 100\text{ mm}$  and  $s_{s1} \geq 100$

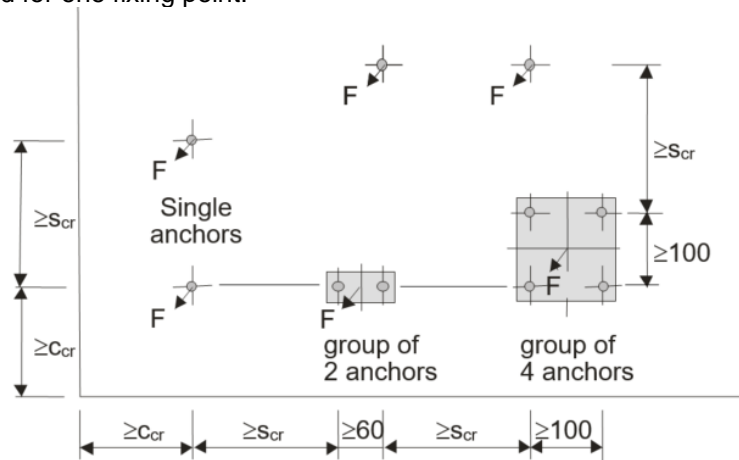
**Materials**
**Mechanical properties**

Anchor size (carbon steel)	HK6	HK6-L	HK8-I
Characteristic bending resistance $M^0_{Rk,s}$ [Nm]	3,6	7,7	18
Anchor size (Stainless steel, HCR)	HK6 -R / -HCR	HK6 L -R / -HCR	HK8 I -R / -HCR
Characteristic bending resistance $M^0_{Rk,s}$ [Nm]	4,0	8,4	20,6

**Material quality**

Part	Marking	Material
HK6 HK6 L HK8 I	K6 K6L K8	Galvanized steel $\geq 5\mu\text{m}$
HK6-R HK6 L-R HK8 I-R	K6E K6LE K8E	Stainless steel 1.4401 or 1.4404
	K6X K6LX K8X	Stainless steel 1.4571
HK6-HCR HK6 L-HCR HK8 I-HCR	K6C K6LC K8C	High corrosion resistant steel 1.4529 or 1.4565

**Anchor dimension**

Anchor size	HK6	
	HK6 M6/t <sub>fix</sub>	HK6 M8/t <sub>fix</sub>
Thread size	External thread M6	External thread M8
Setting tool	HSM 6/t <sub>fix</sub>	HSM 8/t <sub>fix</sub>
Length of thread      l <sub>th</sub> [mm]	5 ≤ l <sub>th</sub> ≤ 50	
Max. thickness of fixture      t <sub>fix</sub> [mm]	t <sub>fix</sub> = l <sub>p</sub> - 7	

Stop drill bit SDS 1

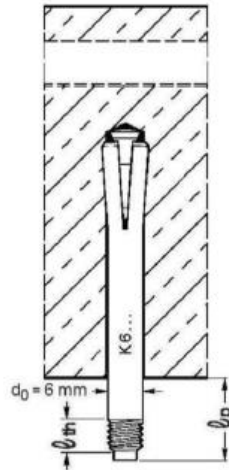
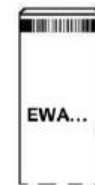
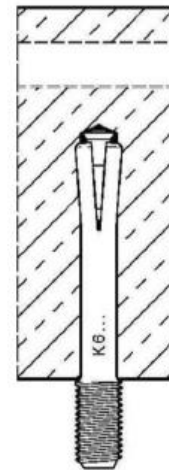
 HK6 M6/t<sub>fix</sub>

 HK6 M8/t<sub>fix</sub>

Setting tool with marking

**Anchor dimension**

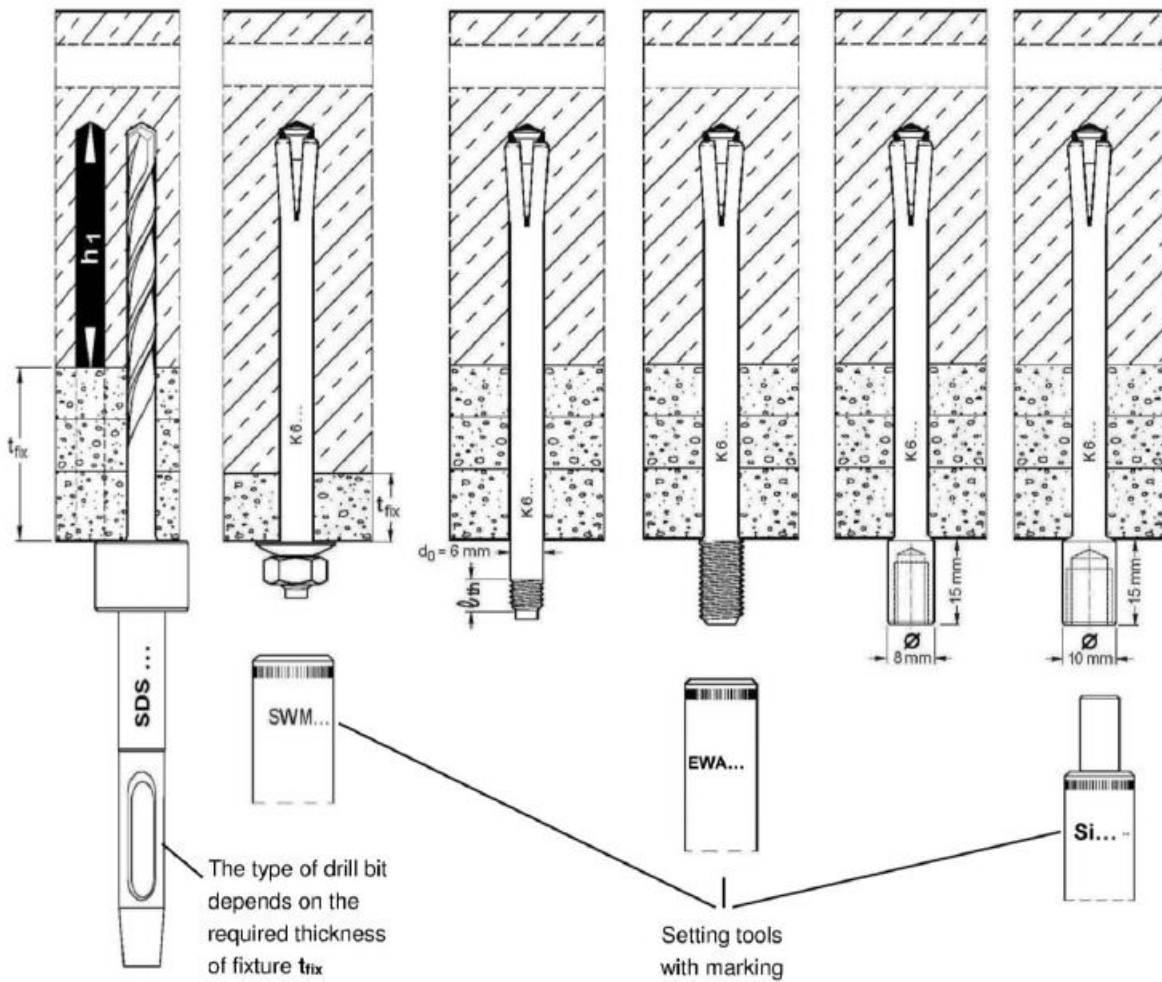
Anchor size		HK6 L				
		HK M6/4 L	HK6 M6/ $t_{fix}$ L	HK6 M8/ $t_{fix}$ L	HK6-I M6 L	HK6-I M8 L
Thread size		External thread M6	External thread M6	External thread M8	Internal thread M6	Internal thread M6
Setting tool		HSM 6/4	HSM 6/ $t_{fix}$	HSM 8/ $t_{fix}$	HSM I M6	HSM I M8
Length of thread	$l_{th}$ [mm]	$\geq 5$	$\geq 5$	$\geq 5$	-	-
Max. thickness of fixture	$t_{fix}$ [mm]	4	$t_{fix} \leq 300$	$t_{fix} \leq 300$	-	-
Available thread length	[mm]	-	-	-	6 to 12	8 to 12



**Anchor dimension**

Anchor size	HK8 I			
	HK8 I M8	HK8 I M10	HK8 I M12	HK8 I M8/M10
Thread size	Internal thread M8	Internal thread M10	Internal thread M12	Internal thread M8 / M10
Setting tool	HSM 8 I M8	HSM 8 I M10	HSM 8 I M12	HSM 8 I M8
Available thread length [mm]	8 to 10	10 to 15	12 to 15	<b>M8:</b> 8 to 10 <b>M10:</b> 10

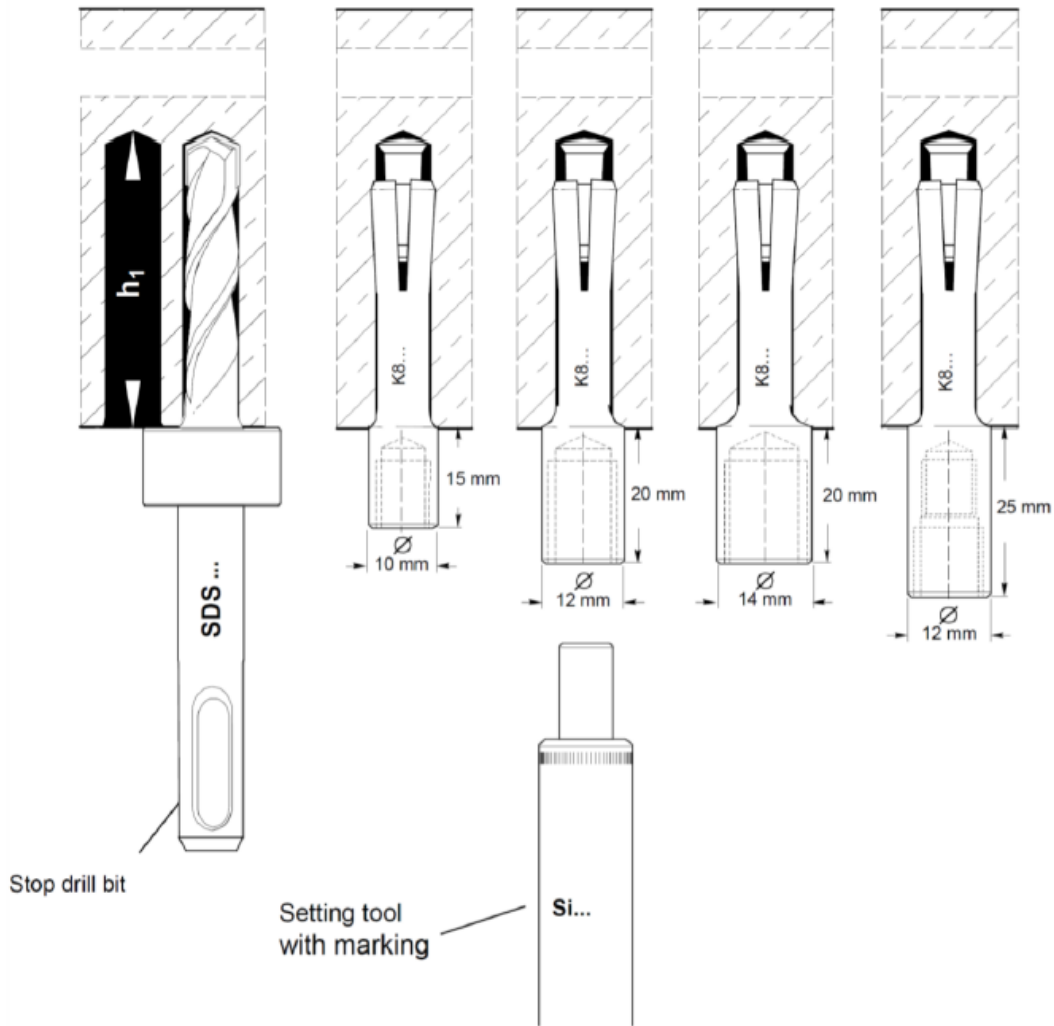



## Setting

### Setting details

Anchor size			HK6				
			HK6 M6/t <sub>fix</sub>		HK6 M8/t <sub>fix</sub>		
Depth of drill hole <sup>a)</sup>	$h_1$	[mm]	32				
Nominal diameter of drill bit	$d_0$	[mm]	6				
Maximum diameter of clearance hole in the fixture	$d_f \leq$	[mm]	7		9		
Max. torque moment	$T_{max}$	[Nm]	5				
Anchor size			HK6 L				
			HK M6/4 L	HK6 M6/t <sub>fix</sub> L	HK6 M8/t <sub>fix</sub> L	HK6-I M6	HK6-I M8 L
Depth of drill hole <sup>a)</sup>	$h_1$	[mm]	42				
Nominal diameter of drill bit	$d_0$	[mm]	6				
Maximum diameter of clearance hole in the fixture	$d_f \leq$	[mm]	7	7	9	9	12
Max. torque moment	$T_{max}$	[Nm]	5				
Anchor size			HK8 I				
			HK8 I M8	HK8 I M10	HK8 I M12	HK8 I M8/M10	
Depth of drill hole <sup>a)</sup>			43				
Setting tool			12	14	16	14	

a) Use stop drill bit to ensure correct depth of bore hole.

### Installation equipment

Anchor size	HK6	HK6-L	HK8-I
Rotary hammer	TE 2 – TE 16		
Stop drill bit <sup>a)</sup>	TE-C/SDS 1	TE-C / SDS 2	TE – C/SDS 3
Setting tool	HSM ... / HSM I ...		HSM 8 .. /HSM 8 I..
Other tools	Blow out pump		

a) In case of through setting choose stop drill bit with appropriate length.

### Setting parameters <sup>a)</sup>

Anchor size	HK6	HK6-L	HK8-I		
Minimum base material thickness	$h_{min} \geq$	[mm]	80		
Effective anchorage depth	$h_{ef}$	[mm]	26	36	36
Critical spacing	$s_{cr}$	[mm]	200		
Critical edge distance	$c_{cr}$	[mm]	150		

a) The critical spacing (critical edge distance) shall be kept. Smaller spacing (edge distance) than critical spacing (critical edge distance) are not covered by the design method.

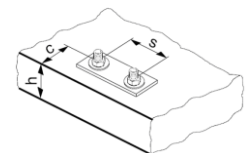

## Setting instruction

\*For detailed information on installation see instruction for use given with the package of the product.





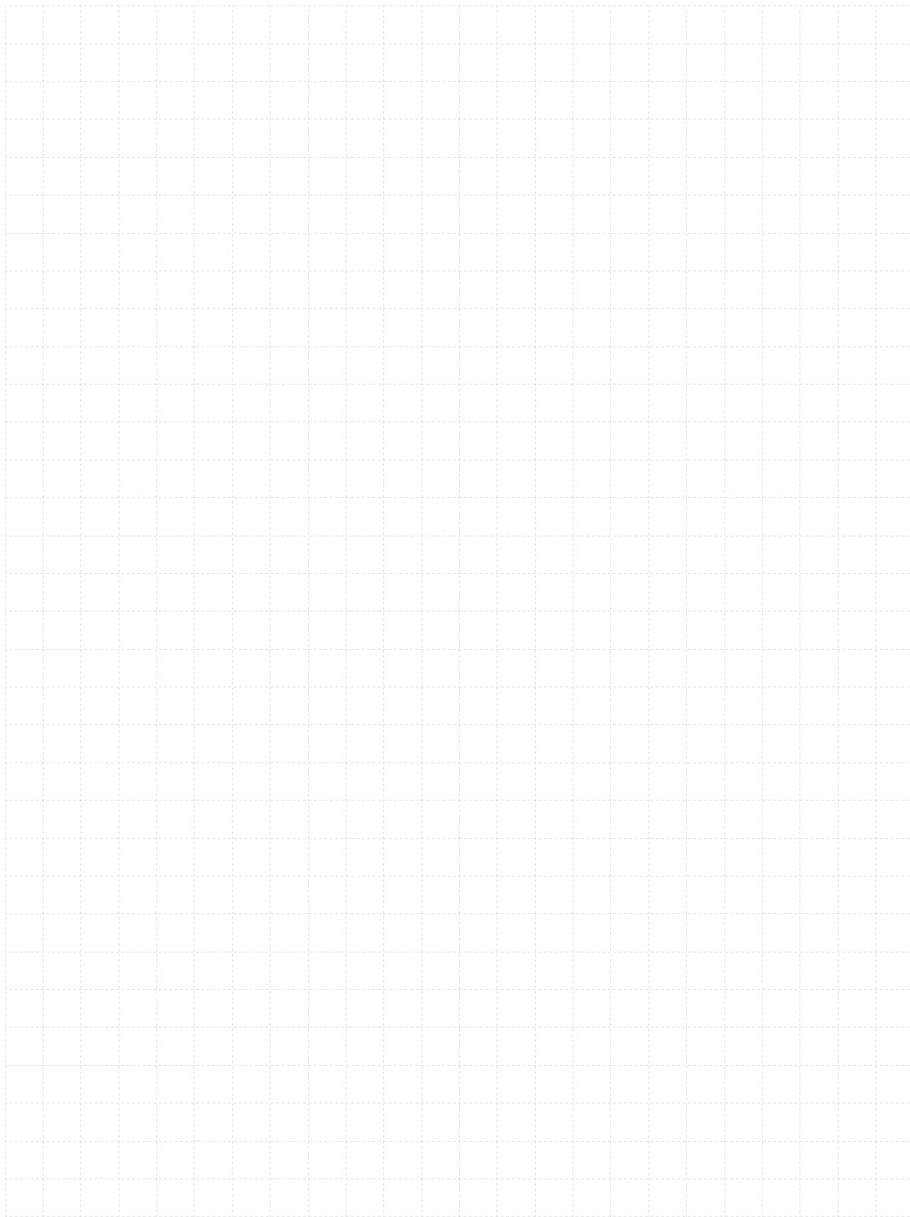

Setting instruction	
External thread	
<p><b>Setting of HK with hand setting tool</b></p>	<p><b>Setting of HK with machine setting tool</b></p>
Internal thread	
<p><b>Setting of HK...-I with hand setting tool</b></p>	<p><b>Setting of HK...-I with machine setting tool</b></p>



### 3.6.4 HLC



# HLC Light duty metal anchors

## Economical sleeve anchor

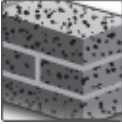
Anchor version			Benefits
	HLC (M5-M16)	Hex head nut with pressed-on washer	- Various head shapes and fastenings thickness
	HLC-H (M5-M16)	Bolt version with washer	
	HLC-L (M5-M16)	Torx round head	
	HLC-SK (M5-M16)	Torx counter sunk head	
	HLC-EC (M5-M16)	Loop-hanger head, eyebold closed	
	HLC-EO (M5-M16)	Loop-hanger head, eyebold open	
	HLC-T (M5-M16)	Ceiling hanger	

Base material	Load condition
 Concrete (non-cracked)  Solid brick	 Fire resistance

### Approvals/certificates

Description	Authority/Laboratory	No./date of issue
Fire test report	IBMB, Braunschweig	PB 3093/517/07-CM / 2007-09-10
Assessment report (fire)	Warringtonfire	WF 327804/A / 2013-07-10

## Basic loading data (for a single anchor)

All data in this section is Hilti technical data and applies to:

- Correct setting (See setting instruction)
- No edge distance and spacing influence
- Concrete as specified in the table
- *Steel* failure
- Minimum base material thickness
- Concrete C 20/25,  $f_{ck,cube} = 25 \text{ N/mm}^2$

### Effective anchorage depth

Anchor size	6,5	8	10	12	16	20
Threaded bolt diameter	M5	M6	M8	M10	M12	M16
Effective anchorage depth $h_{ef}$ [mm]	16	26	31	33	41	41

### Characteristic resistance

Anchor size	6,5	8	10	12	16	20
Threaded bolt diameter	M5	M6	M8	M10	M12	M16
Tension $N_{Rk}$ [kN]	2,1	3,5	4,5	7,2	10,0	13,2
Shear $V_{Rk}$ [kN]	3,2	7,0	8,8	14,4	20,0	20,0

### Design resistance

Anchor size	6,5	8	10	12	16	20
Threaded bolt diameter	M5	M6	M8	M10	M12	M16
Tension $N_{Rd}$ [kN]	1,2	2,0	2,5	4,0	5,6	7,4
Shear $V_{Rd}$ [kN]	1,8	3,9	4,9	8,0	11,1	11,1

### Recommended loads<sup>a)</sup>

Anchor size	6,5	8	10	12	16	20
Threaded bolt diameter	M5	M6	M8	M10	M12	M16
Tension $N_{Rec}$ [kN]	0,8	1,4	1,8	2,9	4,0	5,3
Shear $V_{Rec}$ [kN]	1,3	2,8	3,5	5,7	7,9	7,9

a) With overall partial safety factor for action  $\gamma = 1,4$ . The partial safety factors for action depend on the type of loading and shall be taken from national regulations.

## Materials

### Material quality

Part	Material
Anchor	HLC HLC-EC HLC-EO Carbon steel tensile strength 500 MPa galvanized to min. 5 $\mu\text{m}$
Anchor	HLC-H HLC-L HLC-SK HLC-T Steel bolt strength 8.8, galvanized to min 5 $\mu\text{m}$

**Anchor dimensions**

Anchor version	Anchor size	$h_{ef}$ [mm]	$d$ [mm]	$l$ [mm]	$l_c$ [mm]	$t_{fix}$ [mm]
HLC, HLC-H, HLC-EC/EO carbon steel anchors	6,5 x 25/5	16	M5	30	25	5
	6,5 x 40/20			45	40	20
	6,5 x 60/40			65	60	40
	8 x 40/10	26	M6	46	40	10
	8 x 55/25			61	55	20
	8 x 70/40			76	70	40
	8 x 85/55			91	85	55
	10 x 40/5	31	M8	48	40	5
	10 x 50/15			58	50	15
	10 x 60/25			68	60	25
	10 x 80/45			88	80	45
	10 x 100/65			108	100	65
	12 x 55/15	33	M10	65	55	15
	12 x 75/35			85	75	35
	12 x 100/60			110	100	60
	16 x 60/10	41	M12	72	60	10
	16 x 100/50			112	100	60
	16 x 140/90			152	140	95
	20 x 80/25	41	M16	95	80	25
	20 x 115/60			130	115	60
20 x 150/95	165			150	95	
HLC-SK carbon steel anchors	6,5 x 45/20	16	M5	45	-	20
	6,5 x 65/40			65		40
	6,5 x 85/60			85		60
	8 x 60/25	26	M6	60	-	25
	8 x 75/40			75		40
	8 x 90/55			90		55
	10 x 45/5	31	M8	45	-	5
	10 x 85/45			85		45
	10 x 105/65			105		65
	10 x 130/95			130		95
12 x 55/15	33	M10	80	-	35	

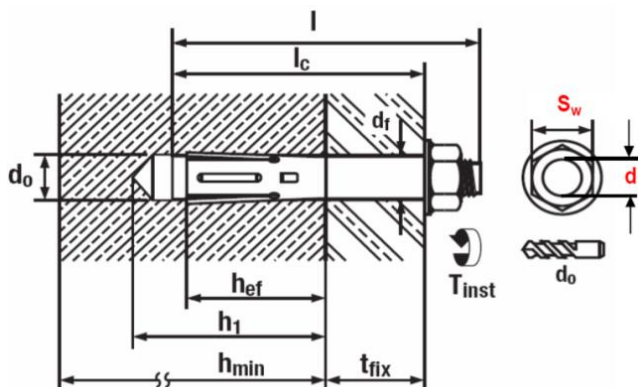
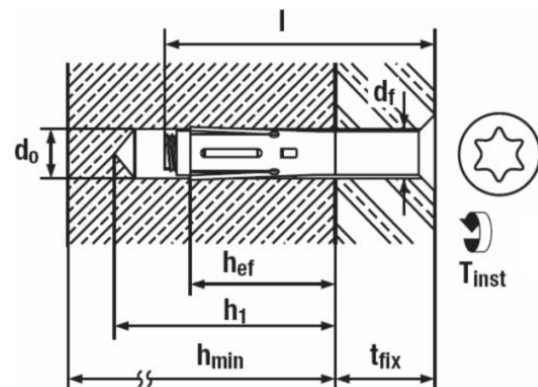
**HLC, HLC-H, HLC-EC/EO, HLC-L**

**HLC-SK**

## Setting information

### Setting details HLC

		M5	M6	M8	M10	M12	M16
Nominal diameter of drill bit	$d_0$ [mm]	6,5	8	10	12	16	20
Cutting diameter of drill bit	$d_{cut} \leq$ [mm]	6,4	8,45	10,45	12,5	16,5	20,55
Depth of drill hole	$h_1 \geq$ [mm]	30	40	50	65	75	85
Width across nut flats	HLC SW [mm]	8	10	13	15	19	24
	HLC-H SW [mm]				17		
	HLS-SK Driver	PZ 3	T 30	T 40	T 40	-	-
Diameter of clearance hole in the fixture	$d_f \leq$ [mm]	7	10	12	14	18	21
Effective anchorage depth	$h_{ef}$ [mm]	16	26	31	33	41	41
Max. torque moment concrete	$T_{inst}$ [Nm]	5	8	25	40	50	80
Max. torque moment masonry	$T_{inst}$ [Nm]	2,5	4	13	20	25	-

### Installation equipment

Anchor size	M5	M6	M8	M10	M12	M16
Rotary hammer for setting	TE 2 – TE 16					
Other tools	hammer, torque wrench, blow out pump					

### Setting parameters

Anchor size	M6	M8	M10	M10	M12	M16	
Minimum base material thickness	$h_{min}$ [mm]	60	70	80	100	100	120
Critical spacing for splitting failure and concrete cone failure	$s_{cr}$ [mm]	60	100	120	130	160	160
Critical edge distance for splitting failure and concrete cone failure	$c_{cr}$ [mm]	30	50	60	65	80	80

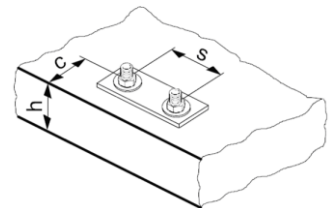

## Setting instruction

\*For detailed information on installation see instruction for use given with the package of the product.

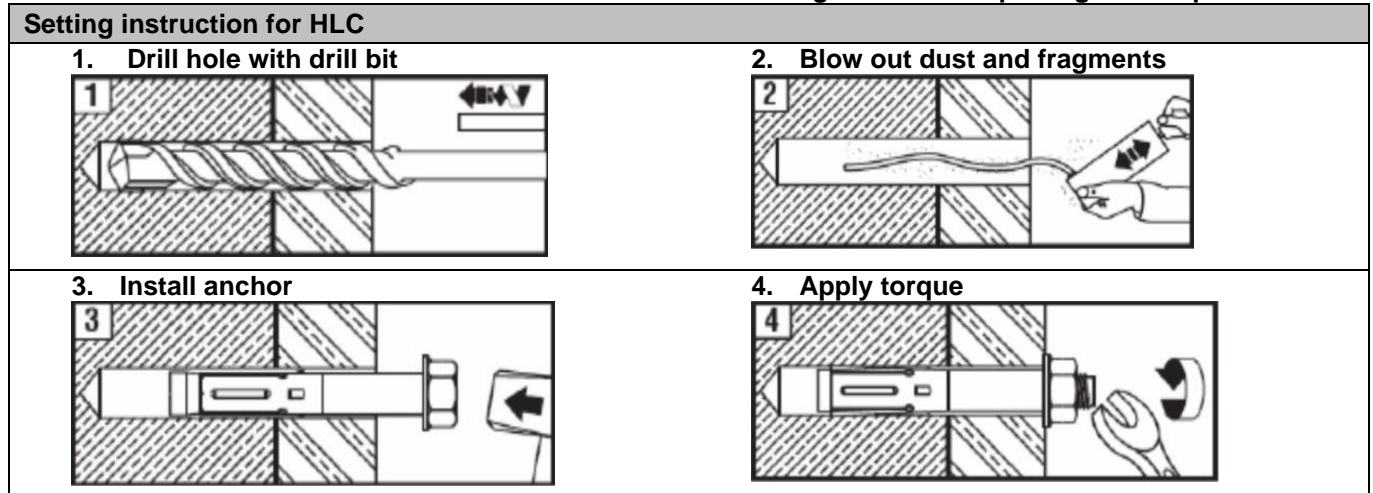

## Basic loading data (for a single anchor) in solid masonry units

### All data in this section applies to

- Load values valid for holes drilled with TE rotary hammers in hammering mode
- Correct anchor setting (see instruction for use, setting details)
- The core / material ratio may not exceed 15% of a bed joint area.
- The brim area around holes must be at least 70mm
- Edge distances, spacing and other influences, see below

### Anchorage depth

Anchor size		M5	M6	M8	M10	M12
Effective anchorage depth	$h_{ef}$ [mm]	16	26	31	33	41

### Recommended loads<sup>a)</sup>

Anchor size		M5	M6	M8	M10	M12	
<b>Solid clay brick Mz12/2,0 (Germany, Austria, Switzerland)</b>							
	DIN 105/ EN 771-1 $f_b^{b)} \geq 12 \text{ N/mm}^2$	Tension $N_{Rec}^{c)}$ [kN]	0,3	0,5	0,6	0,7	0,8
		Shear $V_{Rec}^{c)}$ [kN]	0,45	1,0	1,2	1,4	1,6
<b>Solid clay brick Mz12/2,0 (Germany, Austria, Switzerland)</b>							
	DIN 106/ EN 771-2 $f_b^{b)} \geq 12 \text{ N/mm}^2$	Tension $N_{Rec}^{d)}$ [kN]	0,4	0,5	0,6	0,8	0,8
		Shear $V_{Rec}^{d)}$ [kN]	0,65	1,0	1,2	1,6	1,6

a) Recommended load values for German base materials are based on national regulations.

b)  $f_b$  = brick strength

c) Values only valid for Mz (DIN 105) with brick strength  $\geq 19 \text{ N/mm}^2$ , density  $2,0 \text{ kg/dm}^3$ , min. brick size NF (24,0 cm x 11,5 cm x 11,5 cm)

d) Values only valid for KS (DIN 106) with brick strength  $\geq 29 \text{ N/mm}^2$ , density  $2,0 \text{ kg/dm}^3$ , min. brick size NF (24,0 cm x 11,5 cm x 11,5 cm)



**Permissible anchor location in brick and block walls**

### Anchor position in Brick

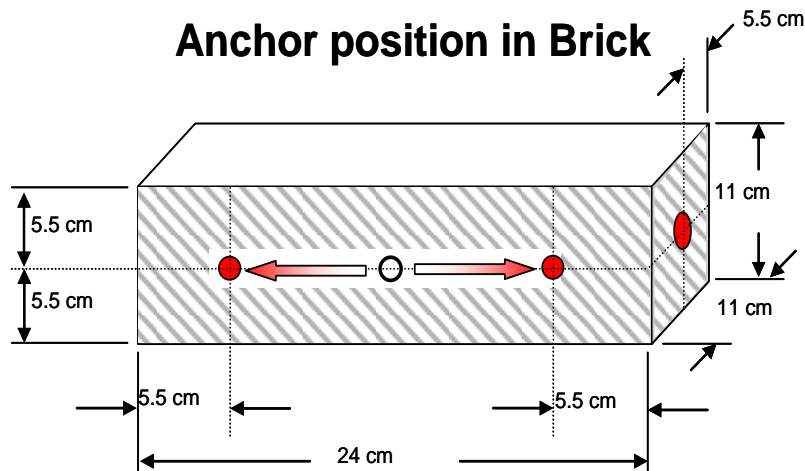
**Edge distance and spacing influences**

- The technical data for the HLC sleeve anchors are reference loads for MZ 12 and KS 12. Due to the large variation of natural stone solid bricks, on site anchor testing is recommended to validate technical data.
- The HLC anchor was installed and tested in center of solid bricks as shown. The HLC anchor was not tested in the mortar joint between solid bricks or in hollow bricks, however a load reduction is expected.
- For brick walls where anchor position in brick cannot be determined, 100% anchor testing is recommended.
- Distance to free edge free edge to solid masonry (Mz and KS) units  $\geq 300$  mm
- The minimum distance to horizontal and vertical mortar joint ( $c_{min}$ ) is stated in the drawing above.
- Minimum anchor spacing ( $s_{min}$ ) in one brick/block is  $\geq 2 \cdot c_{min}$

**Limits**

- Applied load to individual bricks may not exceed 1,0 kN without compression or 1,4 kN with compression
- All data is for multiple use for non-structural applications

Plaster, graveling, lining or levelling courses are regarded as non-bearing and may not be taken into account for the calculation of embedment depth.

### 3.6.5 HT

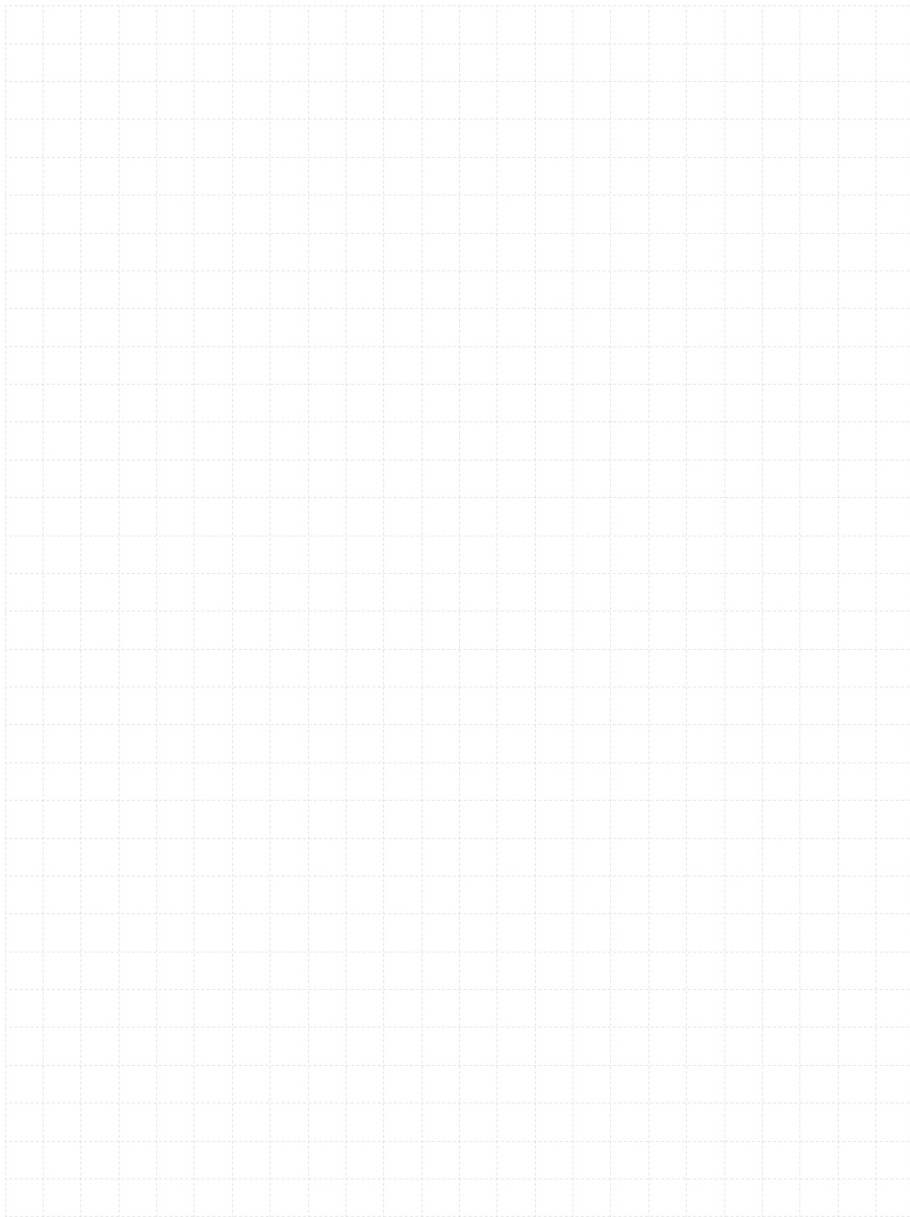

# HT Light duty metal anchors

## Economical metal frame anchor

### Anchor version



HT  
(M8-M10)

### Benefits

- Fastening door and window frames
- No risk of distortion or forces of constraint
- Expansion cone cannot be lost

### Base material



Concrete  
(non-cracked)

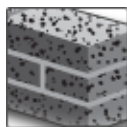

Solid brick

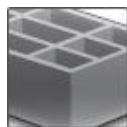

Hollow brick

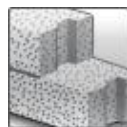

Autoclaved  
aerated  
concrete

### Load conditions



Fire  
resistance

### Approvals / certificates

Description	Authority / Laboratory	No. / date of issue
Fire test report	IBMB, Braunschweig	UB 3016/1114-CM / 2006-03-13
Assessment report (fire)	warringtonfire	WF 327804/A / 2013-07-10

### Basic loading data ( for a single anchor)

#### All data in this section applies to:

- Correct setting (See setting instruction)
- No edge distance and spacing influence
- Base material as specified in the table
- Non-cracked concrete:  $f_{cc} \geq 20 \text{ N/mm}^2$
- Minimum base material thickness

### Anchorage depth

Anchor size		HT 8	HT 10
Nominal embedment depth	$h_{nom}$ [mm]	30	30

### Characteristic resistance

Anchor size		HT 8	HT 10
Concrete, $f_{cc}=30 \text{ N/mm}^2$	$N_{Rk}$ [kN]	4,2	5,0
	$V_{Rk}$ [kN]	6,6	7,0
Aerated concrete PP2 <sup>a)</sup>	$N_{Rk}$ [kN]	-	0,3
	$V_{Rk}$ [kN]	-	0,5
Solid brick Mz 12	$N_{Rk}$ [kN]	1,8	2,6
	$V_{Rk}$ [kN]	-	5,0
Sand-lime solid brick, KS 12	$N_{Rk}$ [kN]	1,8	2,6
	$V_{Rk}$ [kN]	-	5,0
Sand-lime hollow brick, KSL	$N_{Rk}$ [kN]	-	1,5
	$V_{Rk}$ [kN]	-	0,5

a) Rotary drilling only.

**Recommended loads**

Anchor size		HT 8	HT 10
Concrete, $f_{cc}=30 \text{ N/mm}^2$	$N_{Rec}$ [kN]	1,4	1,7
	$V_{Rec}$ [kN]	0,5	0,5
Aerated concrete PP2 <sup>a)</sup>	$N_{Rec}$ [kN]	-	0,1
	$V_{Rec}$ [kN]	-	0,15
Solid brick Mz 12	$N_{Rec}$ [kN]	0,6	0,8
	$V_{Rec}$ [kN]	-	0,5
Sand-lime solid brick KS 12	$N_{Rec}$ [kN]	0,6	0,8
	$V_{Rec}$ [kN]	-	0,5
Sand-lime hollow brick KSL	$N_{Rec}$ [kN]	-	0,5
	$V_{Rec}$ [kN]	-	0,15

a) Rotary drilling only.

**Materials**
**Material quality**

Part	Material
Bolt	Steel strength 4.8, zinc plated to 5 $\mu\text{m}$
Sleeve	Steel 02 DIN 17162, sendzimir zinc plated to 20 $\mu\text{m}$

**Setting information**
**Setting details**

Anchor size		HT 8	8x72	8x92	8x112	8x132	8x152	8x182
Nominal diameter of drill bit	$d_0$ [mm]		8	8	8	8	8	8
Depth of drill hole	$h_1$ [mm]		50	50	50	50	50	50
Nominal embedment depth	$h_{nom}$ [mm]		30	30	30	30	30	30
Anchor length	L [mm]		72	92	112	132	152	182
Torque moment	$T_{inst}^{a)}$ [Nm]		100	100	100	100	100	100
Minimum base material thickness	$h_{min}$ [mm]		4	4	4	4	4	4
Drill bit			TE-CX-8/17		TE-CX-8/22		TE-CX-8/27	

**Setting details**

Anchor size		HT 10	10x72	10x92	10x112	10x132	10x152	10x182	10x202
Nominal diameter of drill bit	$d_0$ [mm]		10	10	10	10	10	10	10
Depth of drill hole	$h_1$ [mm]		50	50	50	50	50	50	50
Nominal embedment depth	$h_{nom}$ [mm]		30	30	30	30	30	30	30
Anchor length	L [mm]		72	92	112	132	152	182	202
Torque moment	$T_{inst}^{a)}$ [Nm]		100	100	100	10	10	10	10
Minimum base material thickness	$h_{min}$ [mm]		8/4	8/4	8/4	8/4	8/4	8/4	8/4
Drill bit			TE-C-10/17		TE-C-10/22		TE-C-10/27		TE-C-10/37

a) First value: solid base material, second value: hollow base material.

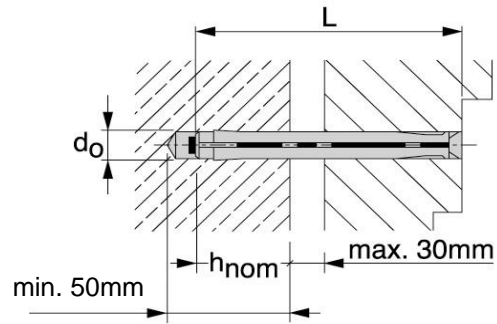

### Installation equipment

Anchor size	HT 8	HT 10
Rotary hammer	TE1-TE16	
Other tools	hammer, screwdriver	

### Setting instruction

\*For detailed information on installation see instruction for use given with the package of the product.

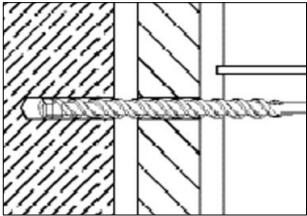
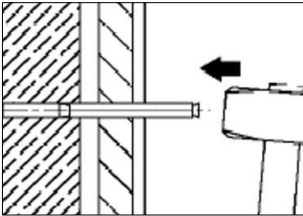
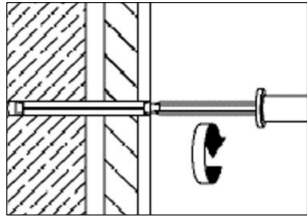
Setting instruction		
<b>1. Drill hole with the drill bit</b> 	<b>2. Install anchor</b> 	<b>3. Drive screw into anchor</b> 

### 3.6.6 HLV

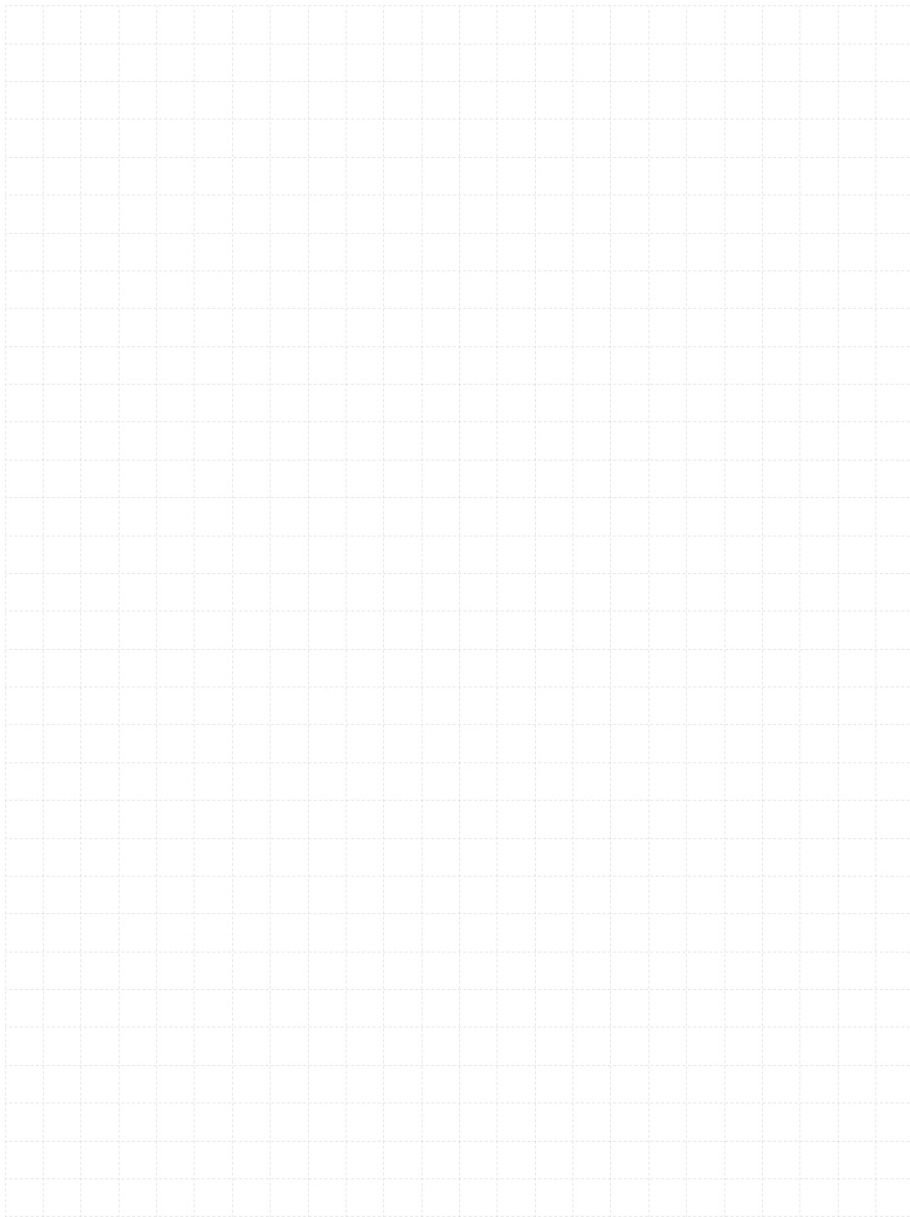
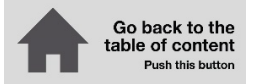

# HLV Light duty anchors

## Economical sleeve anchor

### Anchor version



HLV  
Pre-setting  
(M5-M12)



HLV  
Through fastening  
(M6-M12)

### Benefits

- Available in a variety of sizes in both pre-setting and through fastening configurations
- Carbon steel grade 4.8, zinc galvanized to min 5 $\mu$ m

### Base material



Concrete  
(non-cracked)

### Static resistance

All data in this section is Hilti technical data and applies to:

- Correct setting (See setting instruction)
- No edge distance and spacing influence
- Minimum base material thickness
- Concrete C 20/25,  $f_{ck,cube} = 25 \text{ N/mm}^2 - 60 \text{ N/mm}^2$

### Anchorage depth

Anchor size	Effective anchorage depth	$h_{ef}$	[mm]	Pre-setting						Through fastening			
				6,5x22/7	8x35/4	10x45/10	12x48/10	12x60/17	16x68/20	8x35/10	10x75/45	12x95/60	16x130/90
				22	35	45	48	60	68	25	30	35	40

### Characteristic resistance

Anchor size	Tension	$N_{Rk}$	[kN]	Pre-setting						Through fastening			
				6,5x22/7	8x35/4	10x45/10	12x48/10	12x60/17	16x68/20	8x35/10	10x75/45	12x95/60	16x130/90
				5,2	7,1	13,0	15,9	21,9	28,3	5,6	8,3	10,5	12,8
	Shear	$V_{Rk}$	[kN]	3,3	5,6	11,4	13,0	13,0	19,7	5,6	8,3	10,5	12,8

### Design resistance

Anchor size			Pre-setting					Through fastening				
			6,5x22/7	8x35/4	10x45/10	12x48/10	12x60/17	16x68/20	8x35/10	10x75/45	12x95/60	16x130/90
Tension	$N_{Rd}$	[kN]	2,5	3,4	6,1	7,5	10,4	13,5	2,7	4,0	5,0	6,1
Shear	$V_{Rd}$	[kN]	1,5	2,6	5,4	6,1	6,1	9,4	2,7	4,0	5,0	6,1

### Recommended loads<sup>a)</sup>

Anchor size			Pre-setting					Through fastening				
			6,5x22/7	8x35/4	10x45/10	12x48/10	12x60/17	16x68/20	8x35/10	10x75/45	12x95/60	16x130/90
Tension	$N_{Rec}$	[kN]	1,7	2,4	4,3	5,3	7,4	9,6	1,9	2,8	3,6	4,3
Shear	$V_{Rec}$	[kN]	1,0	1,8	3,8	4,3	4,3	6,7	1,9	2,8	3,6	4,3

a) With overall partial safety factor for action  $\gamma = 1,4$ . The partial safety factors for action depend on the type of loading and shall be taken from national regulations.

### Materials

#### Material quality

Part	Material
Anchor body	Carbon steel, $f_{uk} \geq 400 \text{ N/mm}^2$ galvanised to min. 5 $\mu\text{m}$

#### Anchor dimensions

Anchor size			Pre-setting					Through fastening				
			6,5x22/7	8x35/4	10x45/10	12x48/10	12x60/17	16x68/20	8x35/10	10x75/45	12x95/60	16x130/90
Thread size	d	[-]	M5	M6	M8	M10	M12	M6	M8	M10	M12	
Anchor diameter	$d_1$	[mm]	6,5	8	10	12	16	8	10	12	16	
Length of anchor bolt	l	[mm]	39	51	68	76	95	109	47	88	114	152
Length of sleeve	$l_s$	[mm]	22	35	45	48	60	68	35	75	95	130

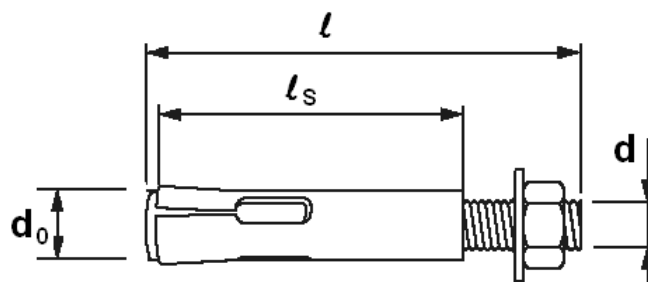



**Setting information**
**Setting details HLV**

Anchor size	Pre-setting						Through fastening			
	6,5x22/7	8x35/4	10x45/10	12x48/10	12x60/17	16x68/20	8x35/10	10x75/45	12x95/60	16x130/90
Thread size	M5	M6	M8	M10		M12	M6	M8	M10	M12
Thickness of fixture $t_{fix} \leq$ [mm]	7	4	10	10	17	20	10	45	60	90
Nominal diameter of drill bit $d_o$ [mm]	6,5 (1/4")	8	10	12		16	8	10	12	16
Cutting diameter of drill bit $d_{cut} \leq$ [mm]	6,4	8,45	10,45	12,5		16,5	8,45	10,45	12,5	16,5
Depth of drill hole $h_1 \geq$ [mm]	40	50	65	70	80	100	40	50	55	70
Width across nut flats SW [mm]	8	10	13	17		19	10	13	17	19
Diameter of clearance hole in the fixture $d_f \leq$ [mm]	6	7	9	11	11	14	10	12	14	18
Effective anchorage depth $h_{ef}$ [mm]	22	35	45	48	60	68	25	30	35	40
Max. torque moment $T_{inst}$ [Nm]	2	4	25	40		50	4	25	40	50

**Installation equipment**

Anchor size	6,5	8	10	M12	M16
Rotary hammer for setting	TE 2 – TE 16				
Other tools	hammer, torque wrench, blow out pump				

**Setting parameters**

Anchor size	Pre-setting						Through fastening			
	6,5x22/7	8x35/4	10x45/10	12x48/10	12x60/17	16x68/20	8x35/10	10x75/45	12x95/60	16x130/90
Minimum base material thickness $h_{min} \geq$ [kN]	80	80	90	100	120	140	80 <sup>a)</sup>	80 <sup>a)</sup>	80 <sup>a)</sup>	80 <sup>a)</sup>
Minimum spacing $s_{min} \geq$ [mm]	200	200	200	200	240	280	200	200	200	200
Minimum edge distance $c_{min} \geq$ [mm]	100	105	135	150	180	210	100	100	105	120

a) In case of deeper embedment than  $h_{ef}$ ,  $h_{min} \geq 2x$  embedment depth.

## Setting instruction

\*For detailed information on installation see instruction for use given with the package of the product.

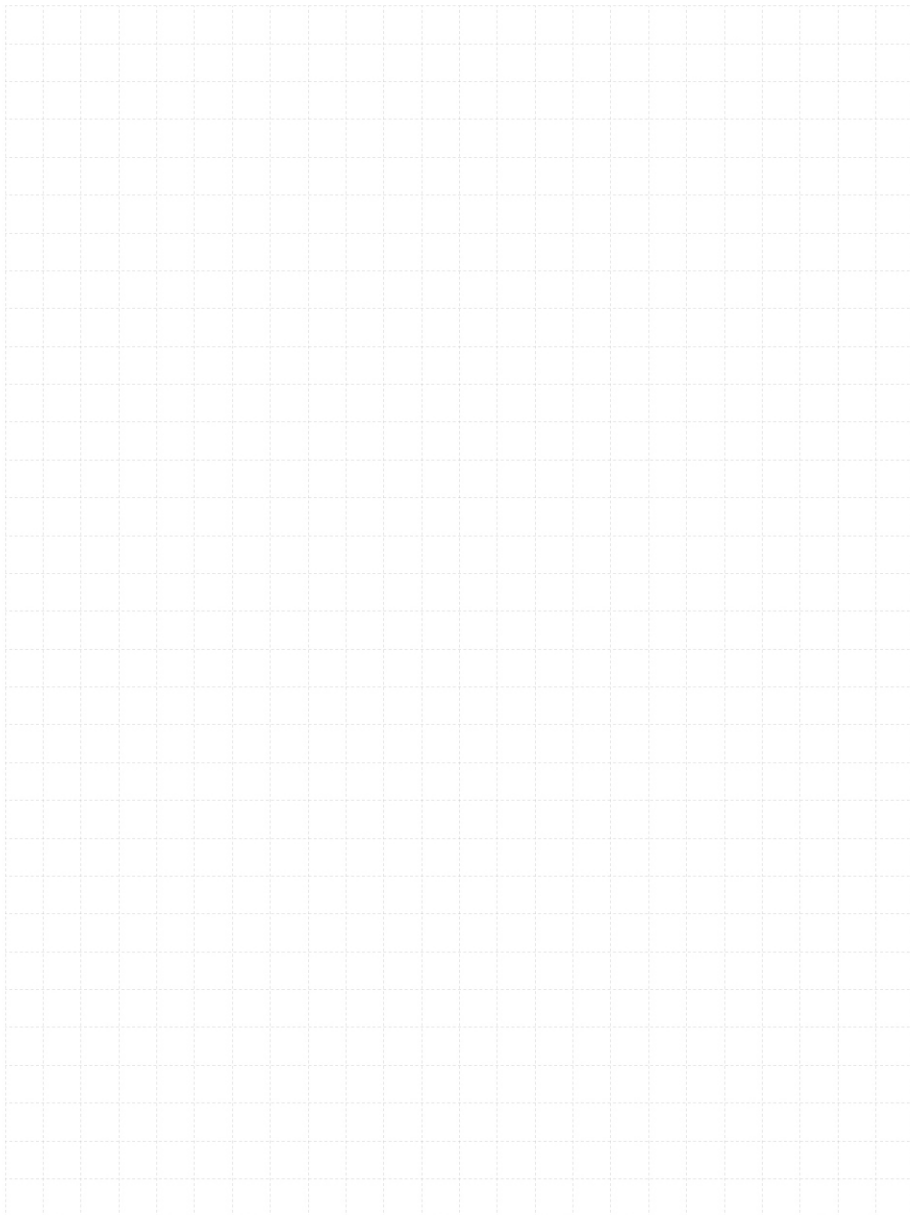

Setting instruction	
Pre-setting	
<p><b>1.</b></p>	<p><b>2. Drilling</b></p>
<p><b>3. Cleaning</b></p>	<p><b>4. Inserting the anchor</b></p>
<p><b>5. Inserting the anchor by hammer</b></p>	<p><b>6. Attaching the belonging washer</b></p>
Through fastening	
<p><b>1.</b></p>	<p><b>2. Drilling</b></p>
<p><b>3. Cleaning</b></p>	<p><b>4. Inserting the anchor by hammer</b></p>
<p><b>5. Attaching the belonging washer</b></p>	

### 3.6.7 HAM



# HAM Light duty metal anchors

## Economical sleeve anchor

Anchor version		Benefits
	HAM 8.8 screw (M6-M12)	<ul style="list-style-type: none"> <li>- Secure fastenings in various base materials</li> <li>- Cone attached to sleeve to ensure pre-setting</li> <li>- Wings to prevent spinning in the borehole</li> <li>- Plastic cap in cone to prevent dust entrance</li> <li>- Blue-chromate zinc coating</li> <li>- 8.8 steel strength of screw</li> </ul>
	HAM (M6-M12)	

### Base material



Concrete  
(non-cracked)

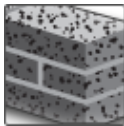

Solid brick

### Basic loading data (for a single anchor)

#### All data in this section applies to:

- Correct setting (See setting instruction)
- No edge distance and spacing influence
- Concrete as specified in the table
- Steel failure
- Minimum base material thickness
- Concrete C 20/25,  $f_{ck,cube} = 25 \text{ N/mm}^2$

#### Anchorage depth

Thread diameter		M6x50	M8x60	M10x80	M12x90
Effective anchorage depth	$h_{ef}$ [mm]	30	35	43	55

#### Recommended loads in non-cracked concrete C20/25

Thread diameter		M6x50	M8x60	M10x80	M12x90
Tension	$N_{Rec}$ [kN]	4,0	4,8	5,8	8,7
Shear	$V_{Rec}$ [kN]	4,6	8,4	13,3	19,3

#### Recommended loads in solid brick

Thread diameter		M6x50	M8x60	M10x80	M12x90
Tension	$N_{Rec}$ [kN]	For solid brick, load values need to be determined on the building site			
Shear	$V_{Rec}$ [kN]				

## Materials

### Material quality

Part	Material	
HAM Anchor	Sleeve	Carbon steel
	Hex head bolt	Carbon steel DIN 933, Strength 8.8
	Washer	Carbon steel, DIN 9021

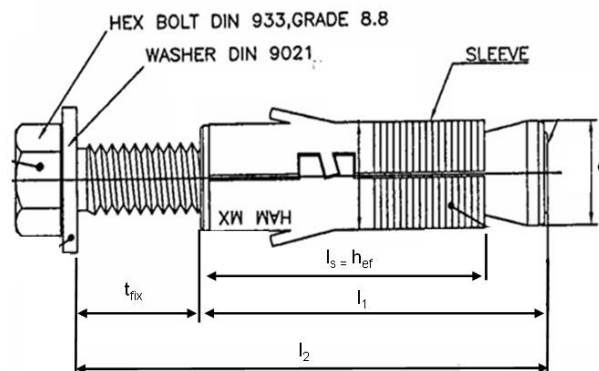

### Anchor dimension of HAM

Anchor size			M6x50	M8x60	M10x80	M12x90
Effective anchorage depth	$h_{ef}$	[mm]	30	35	43	55
Anchor diameter	$d$	[mm]	12	14	16	19
Sleeve length	$l_s = h_{ef}$	[mm]	30	35	43	55
Length of expansion sleeve	$l_1$	[mm]	40	50	60	70
Length of anchor	$l_2$	[mm]	50	60	80	90
Thickness of the fixture	$t_{fix}$	[mm]	10	10	20	20

## Setting

### Setting details of HAM

Anchor size			M6x50	M8x60	M10x80	M12x90
Nominal diameter of drill bit	$d_0$	[mm]	12	14	16	20
Cutting diameter of drill bit	$d_{cut} \leq$	[mm]	12,5	14,5	16,5	20,55
Depth of drill hole	$h_1 \geq$	[mm]	65	80	90	110
Width across nut flats	SW	[mm]	10	13	17	19
Diameter of clearance hole in the fixture	$d_f \leq$	[mm]	7	9	12	14
Max. torque moment concrete	$T_{inst}$	[Nm]	10	25	45	75
Max. torque moment masonry	$T_{inst}$	[Nm]	5	10	20	30

### Installation equipment

Anchor size		M6x50	M8x60	M10x80	M12x90
Rotary hammer for setting		TE 2 – TE 16			
Drill bit	TE-C3X	12	14	16	20
Other tools		hammer, torque wrench, blow out pump			

\*For detailed information on installation see instruction for use given with the package of the product.

### Setting instruction

#### Pre-setting

##### 1. Drilling

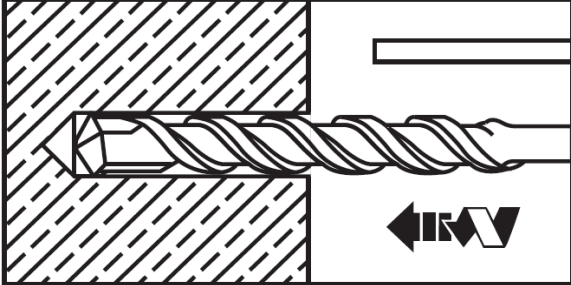

##### 2. Cleaning

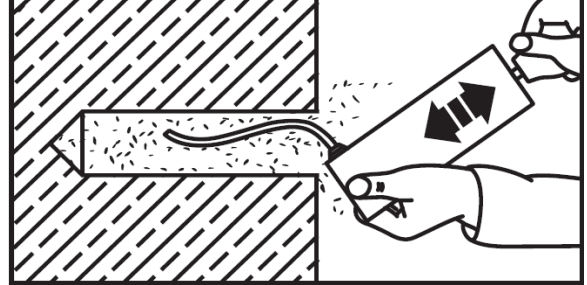

##### 3. Inserting the anchor by hammer

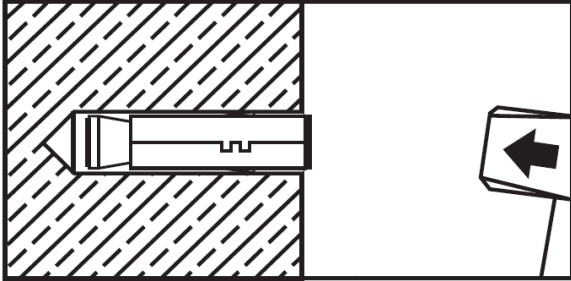

##### 4. Torquing the anchor

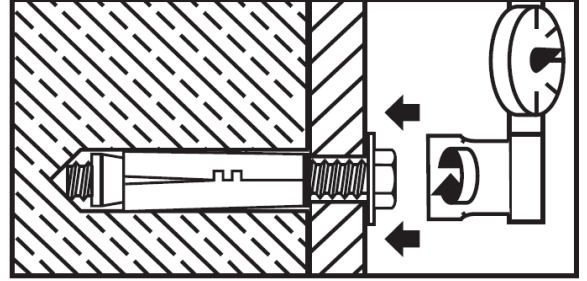

### 3.6.8 HPD

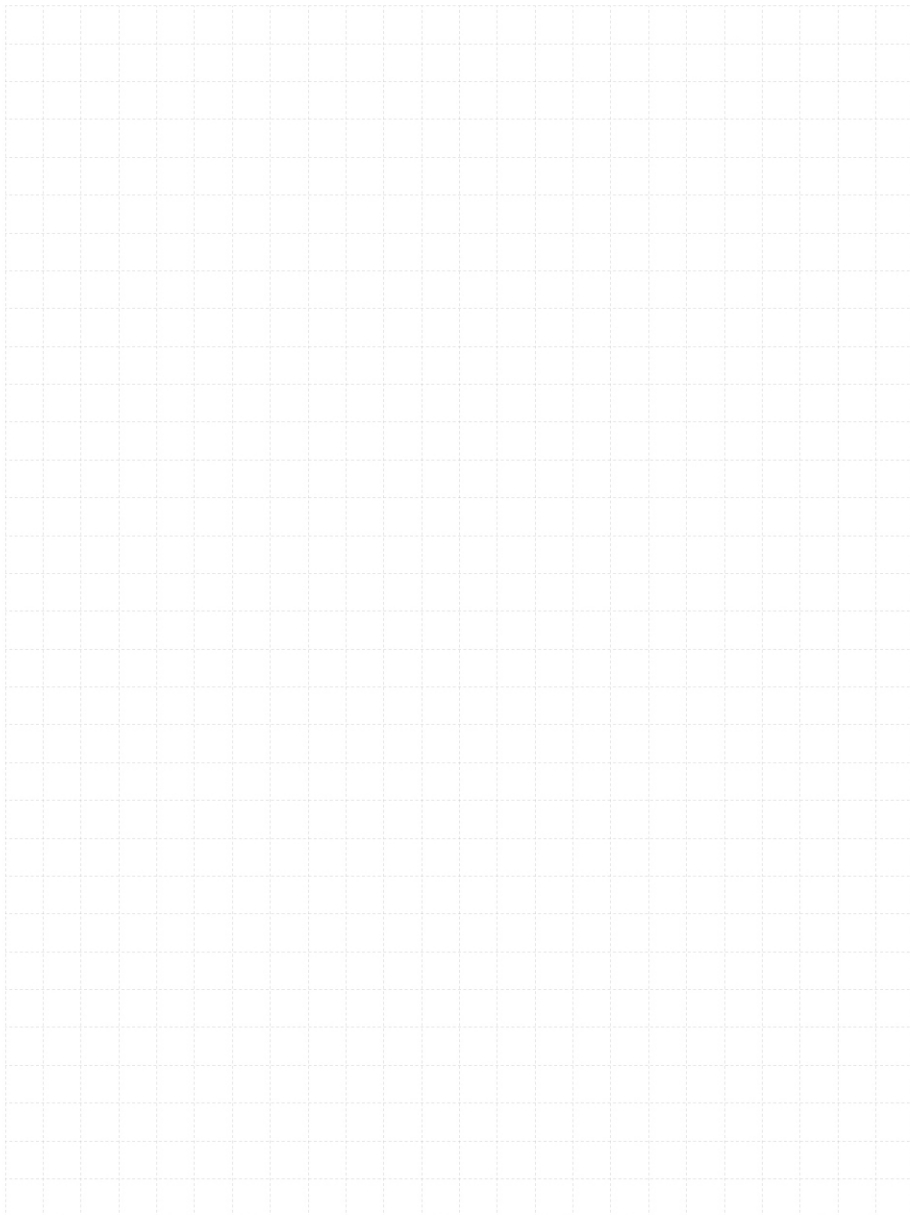

# HPD Light duty metal anchors

## Aerated concrete anchor

### Anchor version



HPD  
(M6-M10)

### Benefits

- Anchor for autoclaved aerated concrete
- Maximum use of base material capacity
- Setting without drilling

### Base material



Autoclaved  
aerated  
concrete

### Load conditions



Fire  
resistance

### Other information



Sprinkler  
approved

### Approvals / certificates

Description	Authority / Laboratory	No. / date of issue
Allgemeine bauaufsichtliche Zulassung (national approval in Germany) <sup>a)</sup>	DIBt, Berlin	Z-21.1-1729 / 2021-06-02
Fire test report	IBMB, Braunschweig	UB 3077/3602-Nau- / 2002-02-05
Assessment report (fire)	warringtonfire	WF 327804/A / 2013-07-10
Sprinkler	VdS, Cologne	G 4981083 / 2008-01-01



## Basic loading data

### All data in this section applies to:

- Correct setting (See setting instruction)
- No edge distance and spacing influence
- Autoclaved aerated concrete (AAC)
- Load data given in the tables is independent of load direction
- Minimum base material thickness

### Anchorage depth

Anchor size		M6	M8	M10
Effective anchorage depth	$h_{ef}$ [mm]	62	62	62

### Recommended loads for a single anchor

Anchor size			M6	M8	M10
<b>Non-cracked AAC<sup>a)</sup></b>					
AAC blocks	AAC 2	$F_{Rec}$ [kN]	0,4	0,4	0,6
	AAC 4, AAC 6	$F_{Rec}$ [kN]	0,8	0,8	1,2
AAC wall members	P 3,3	$F_{Rec}$ [kN]	0,6	0,6	0,8
	P 4,4	$F_{Rec}$ [kN]	0,8	0,8	1,2
<b>Cracked AAC</b>					
AAC ceiling members	P 3,3	$F_{Rec}$ [kN]	0,6	0,6	0,8
	P 4,4	$F_{Rec}$ [kN]	0,8	0,8	1,2

a) In case of small sized AAC blocks ( $\leq 250\text{mm} \times 500\text{mm} \times \text{thickness}$ ) the recommended load has to be reduced with a factor 0,6.

### Recommended loads for a group of two anchor with a spacing $100\text{mm} \leq s \leq 200\text{mm}$

Anchor size			M6	M8	M10
<b>Non-cracked AAC<sup>a)</sup></b>					
AAC blocks	AAC 2	$F_{Rec}$ [kN]	0,4	0,4	0,6
	AAC 4, AAC 6	$F_{Rec}$ [kN]	0,8	0,8	1,2
AAC wall members	P 3,3	$F_{Rec}$ [kN]	0,6	0,6	0,8
	P 4,4	$F_{Rec}$ [kN]	0,8	0,8	1,2
<b>Cracked AAC</b>					
AAC ceiling members	P 3,3	$F_{Rec}$ [kN]	0,6	0,6	0,8
	P 4,4	$F_{Rec}$ [kN]	0,8	0,8	1,2

a) In case of small sized AAC blocks ( $\leq 250\text{mm} \times 500\text{mm} \times \text{thickness}$ ) the recommended load has to be reduced with a factor 0,6.

### Recommended loads for a group of two anchor with a spacing $s \geq 200\text{mm}$

Anchor size			M6	M8	M10
<b>Non-cracked AAC<sup>a)</sup></b>					
AAC blocks	AAC 2	$F_{Rec}$ [kN]	0,6	0,6	0,8
	AAC 4, AAC 6	$F_{Rec}$ [kN]	1,1	1,1	1,7
AAC wall members	P 3,3	$F_{Rec}$ [kN]	0,8	0,8	1,1
	P 4,4	$F_{Rec}$ [kN]	1,1	1,1	1,7
<b>Cracked AAC</b>					
AAC ceiling members	P 3,3	$F_{Rec}$ [kN]	0,8	0,8	1,1
	P 4,4	$F_{Rec}$ [kN]	1,1	1,1	1,7

a) In case of small sized AAC blocks ( $\leq 250\text{mm} \times 500\text{mm} \times \text{thickness}$ ) the recommended load has to be reduced with a factor 0,6.

## Materials

### Mechanical properties

Anchor size				M6	M8	M10
Nominal tensile strength	Carbon steel	$f_{uk}$	[N/mm <sup>2</sup> ]	800	500	500
	Stainless steel			750	565	565
Yield strength	Carbon steel	$f_{yk}$	[N/mm <sup>2</sup> ]	-	-	-
	Stainless steel			-	-	-
Stressed cross-section		$A_s$	[mm <sup>2</sup> ]	20,1	36,6	58
Moment of resistance		$W$	[mm <sup>3</sup> ]	12,7	31,2	62,3
Characteristic bending resistance for rod or bolt	Carbon steel	$M^{0}_{Rk,s}$	[Nm]	12	19	37
	Stainless steel			11	21	42

### Material quality

Part	Material
All parts	HPD
	Carbon steel, galvanised to min. 5 µm
	HPD (stainless steel)
	Stainless steel

### Anchor dimension

Anchor size				M6	M8	M10
Minimum thickness of fixture	$t_{fix,min}$	[mm]	0	0	0	
Maximum thickness of fixture	$t_{fix,max}$	[mm]	30	20	30	
Anchor diameter	$d_1$	[mm]	9,8	11,8	13,8	
Length of the expansion sleeve	$l_c$	[mm]	70			
Length of the cone	$l_d$	[mm]	12			

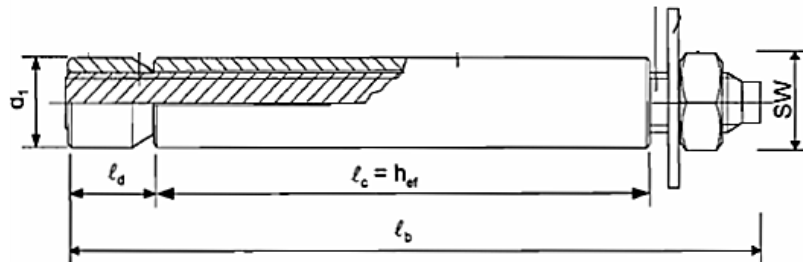

### Setting information

#### Setting details

Anchor size				M6	M8	M10
Diameter of clearance hole in the fixture	$d_f \leq$	[mm]	7	9	12	
Effective anchorage depth	$h_{ef}$	[mm]	62	62	62	
Torque moment	$T_{inst}$	[Nm]	3	5	8	
Width across	$SW$	[mm]	10	13	17	

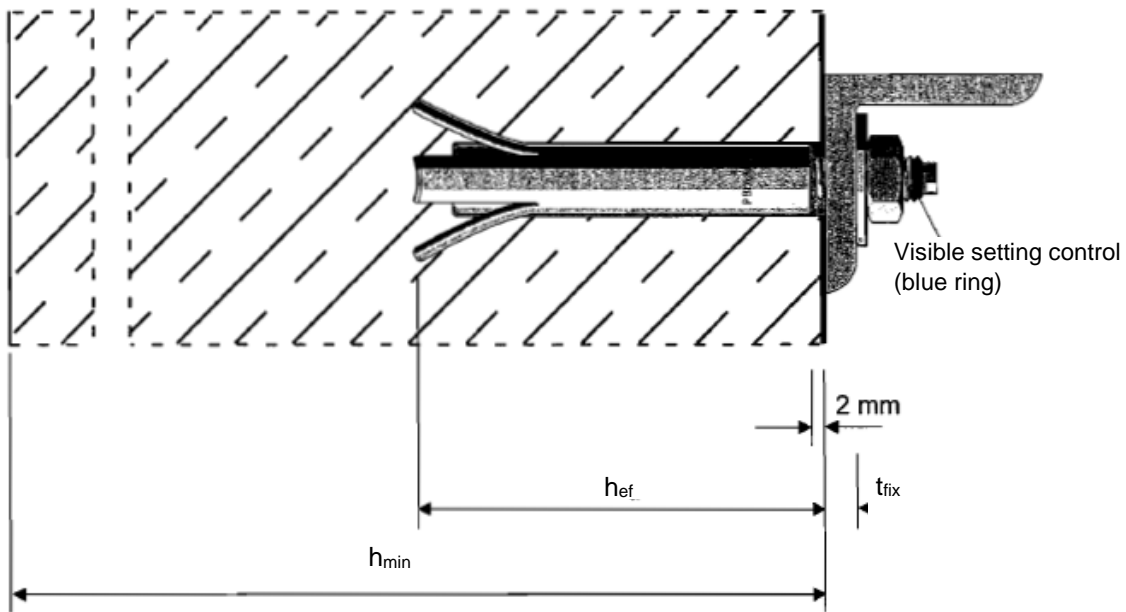

### Installation equipment

Anchor size		M6/10	M6/30	M8/10	M8/20	M10/10	M10/30
Setting tool	Manual setting tool (to be used with a hammer)	HPE-G 6/10	HPE-G 6/30	HPE-G 8/10	HPE-G 8/20	-	-
	Machine setting (to be used with a rotary hammer in pure hammering mode)	-	-	-	-	HPE-M 10/10	HPE-M 10/30

### Setting parameters

Anchor size				M6	M8	M10
Minimum base material thickness		$h_{min}$	[mm]	175		
Minimum spacing	Of anchors in a group	$s_{min,anchor}$	[mm]	100 / 200		
	Of anchor groups	$s_{min,group}$	[mm]	600		
Minimum edge distance	to member edge and to vertical joints	$c_{min,1}$	[mm]	150	150	150
	to horizontal joints	$c_{min,2}$	[mm]	50	50	50

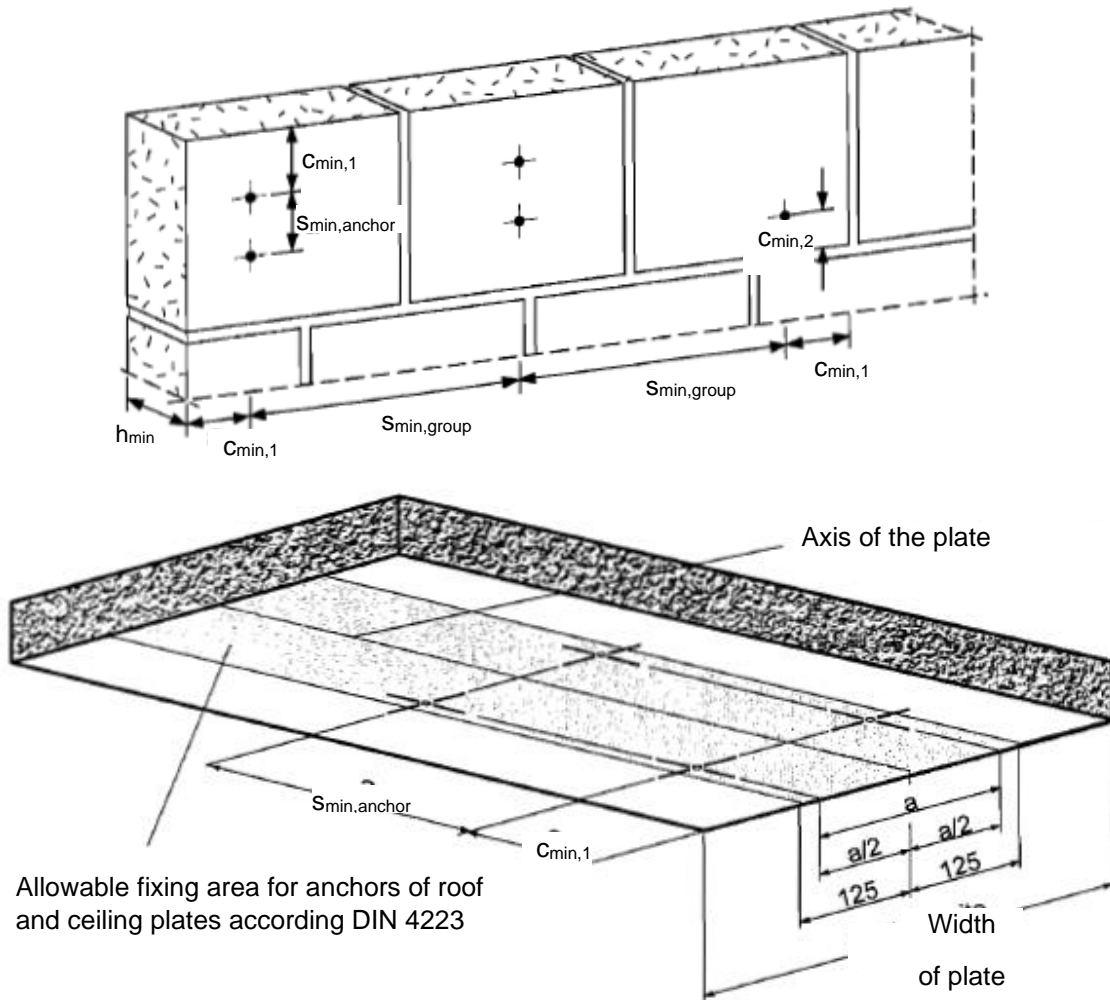

### Setting instruction

\*For detailed information on installation see instruction for use given with the package of the product.

Setting instruction			
<p>1. Insert the cone bolt by hammering it in, until setting tool touches surface.</p>	<p>2. Insert the expansion sleeve over the threaded rod.</p>	<p>3. Drive in the sleeve by hammering or with the machine setting tool.</p>	<p>4. Tighten the nut until the blue ring becomes visible.</p>

### 3.6.9 HKH

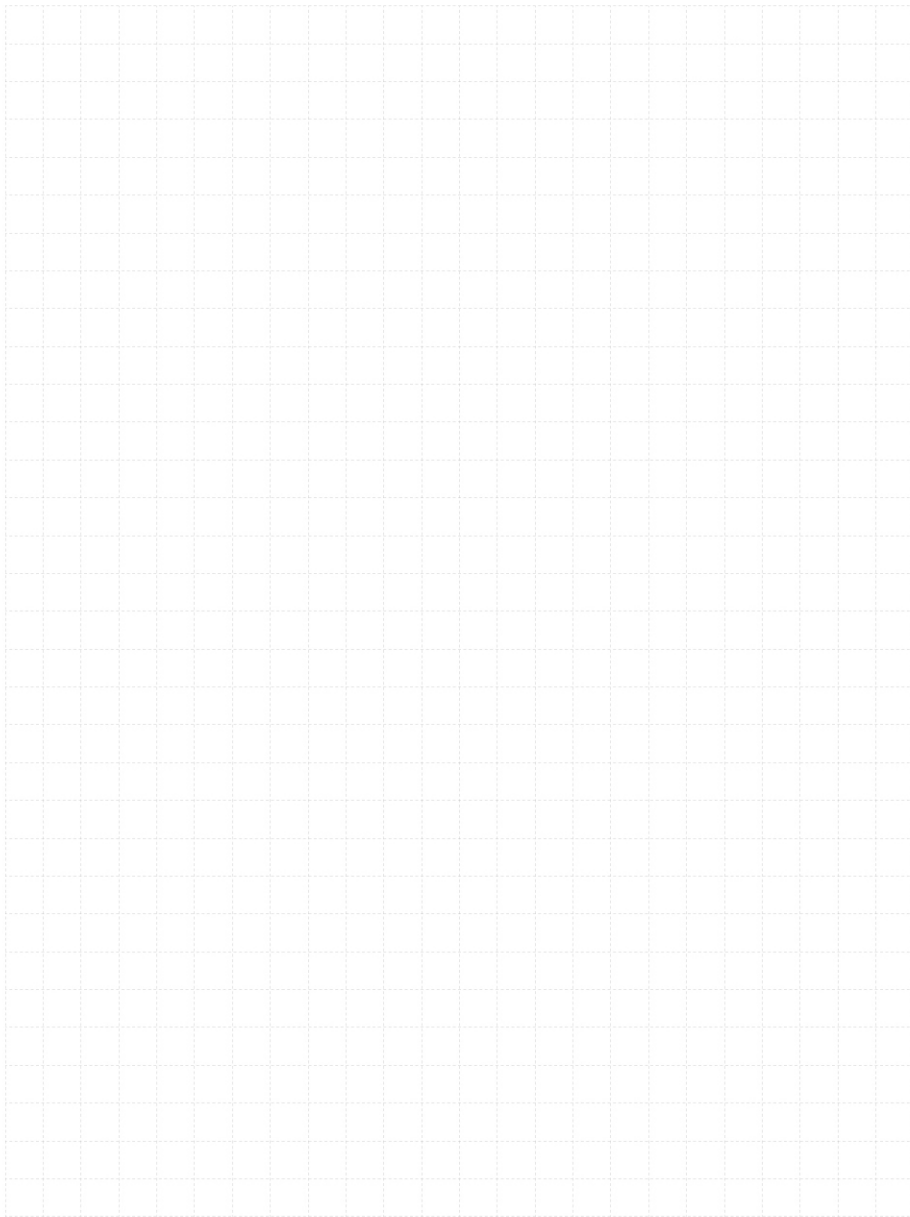

# HKH Light duty metal anchors

## Hollow deck anchor

### Anchor version



HKH  
(M6-M10)

### Benefits

- Anchor for suspended ceilings and overhead support applications
- Maximum use of base material capacity
- Setting without drilling

### Base material



Prestressed hollow core slabs

### Load condition



Fire resistance

### Other information



Corrosion resistance



Sprinkler approved

### Approvals / certificates

Description	Authority / Laboratory	No. / date of issue
Allgemeine bauaufsichtliche Zulassung (national approval in Germany for a single point fastening) <sup>a)</sup>	DIBt, Berlin	Z-21.1-1722 / 2022-01-20
Fire test report	IBMB, Braunschweig	UB 3606 / 8892 / 2002-07-22
Assessment report (fire)	warringtonfire	WF 327804/A / 2013-07-10
Sprinkler	VdS, Cologne	G 4961028 / 2006-09-05

a) All data given in this section according DIBt Z-21.1-1722, issue 2011-10-31.

## Basic loading data

### All data in this section applies to:

- Correct setting (See setting instruction)
- No edge distance and spacing influence
- Hollow decks where  $w \leq 4,2 \cdot e$
- Hollow decks, classification  $\geq C 45/55$
- Concrete  $f_{cc} \geq 50 \text{ N/mm}^2$

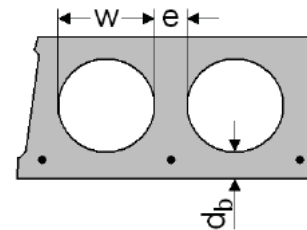

### Recommended loads

Anchor size	M6	M8	M10	M6	M8	M10	M6	M8	M10
Cavity to surface thickness $d_b$ [mm]	$\geq 25$			$\geq 30$			$\geq 40$		
<b>For a single anchor</b>									
Tension <sup>a)</sup> $F_{rec}$ [kN]	0,7	0,7	0,9	0,9	0,9	1,2	2,0	2,0	3,0
<b>For a group of two anchors with a spacing <math>s \geq 100 \text{ mm}</math> and <math>\leq 200 \text{ mm}</math></b>									
Tension <sup>a)</sup> spacing $s \geq 100 \text{ mm}$ $F_{rec}$ [kN]	0,9	0,9	1,2	1,2	1,2	1,6	2,5	2,5	4,0
spacing $s \geq 200 \text{ mm}$ $F_{rec}$ [kN]	1,1	1,1	1,5	1,5	1,5	2,0	3,3	3,3	5,0
<b>For a group of four anchors with a spacing <math>s \geq 100 \text{ mm}</math> and <math>\leq 200 \text{ mm}</math></b>									
Tension <sup>a)</sup> spacing $s \geq 100/100 \text{ mm}$ $F_{rec}$ [kN]	1,2	1,2	1,6	1,6	1,6	2,1	3,5	3,5	5,3
spacing $s \geq 100/200 \text{ mm}$ $F_{rec}$ [kN]	1,5	1,5	2,0	2,0	2,0	2,6	4,4	4,4	6,6
spacing $s \geq 200/200 \text{ mm}$ $F_{rec}$ [kN]	1,9	1,9	2,5	2,5	2,5	3,3	5,5	5,5	8,3

a) The given loads are valid for tension load, shear load and all load directions.

## Materials

### Mechanical properties

Anchor size	M6	M8	M10
Nominal tensile strength $f_{uk}$	Carbon steel	500	500
	Stainless steel	700	700
Admissible bending resistance	Carbon steel	10,7	21,4
	Stainless steel	4,9	24,1

### Material quality

Part	Material	
All parts	HKH (Carbon steel)	Galvanised to min. 5 $\mu\text{m}$
	HKH (Stainless steel)	Stainless steel A4

### Anchor dimension

Anchor size	M6	M8	M10
Thickness of fixture $t_{fix}$ [mm]	$\leq 10$	$\leq 10$	$\leq 10$
Length of the spacer sleeve $l_l$ [mm]	0	0	0
Length of the part of the sleeve $l_{hl}$ [mm]	10	10	10
Anchor diameter $d$ [mm]	9,8	11,8	13,8
Length of the bolt $l$ [mm]	86	88	93
Length of the part of the sleeve $l_h$ [mm]	55		

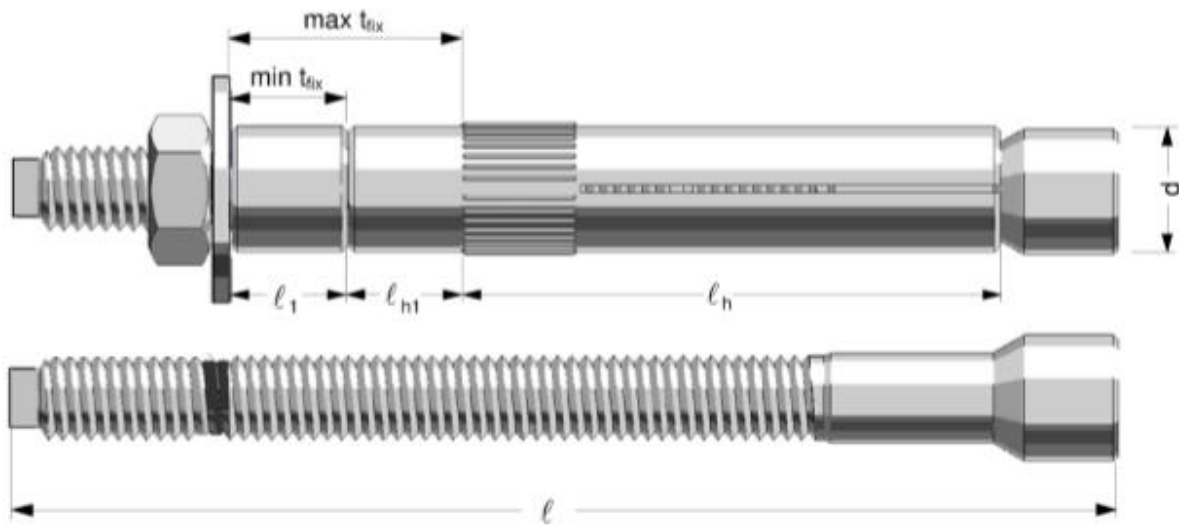

## Setting information

### Setting details

Anchor size		M6	M8	M10
Diameter of clearance hole in the fixture	$d_f \leq$ [mm]	12	14	16
Embedment depth for HKH	$h_s$ [mm]	55 to 65		
Torque moment	$T_{inst}$ [Nm]	5	10	20
Width across	SW [mm]	10	13	17

### Installation equipment

Anchor size	M6	M8	M10
Drill bit	TE-CX-10	TE-CX-12	TE-CX-14
Rotary hammer	TE 6A, TE 6C, TE 6S, TE 15, TE 15-C, TE 18-M		
Setting tools	Torque wrench		
Machine setting tool	available		

### Setting parameters

Anchor size		M6	M8	M10
Edge distance <sup>a)</sup>	$c \geq$ [mm]	150		
	$c_{min} \geq$ [mm]	100		
Spacing between outer anchors of neighbouring fixation	$a \geq$ [mm]	300		

a) For edge distance < 150 mm the recommended load has to be reduced with  $F=0,75 \cdot F_{rec}$ .



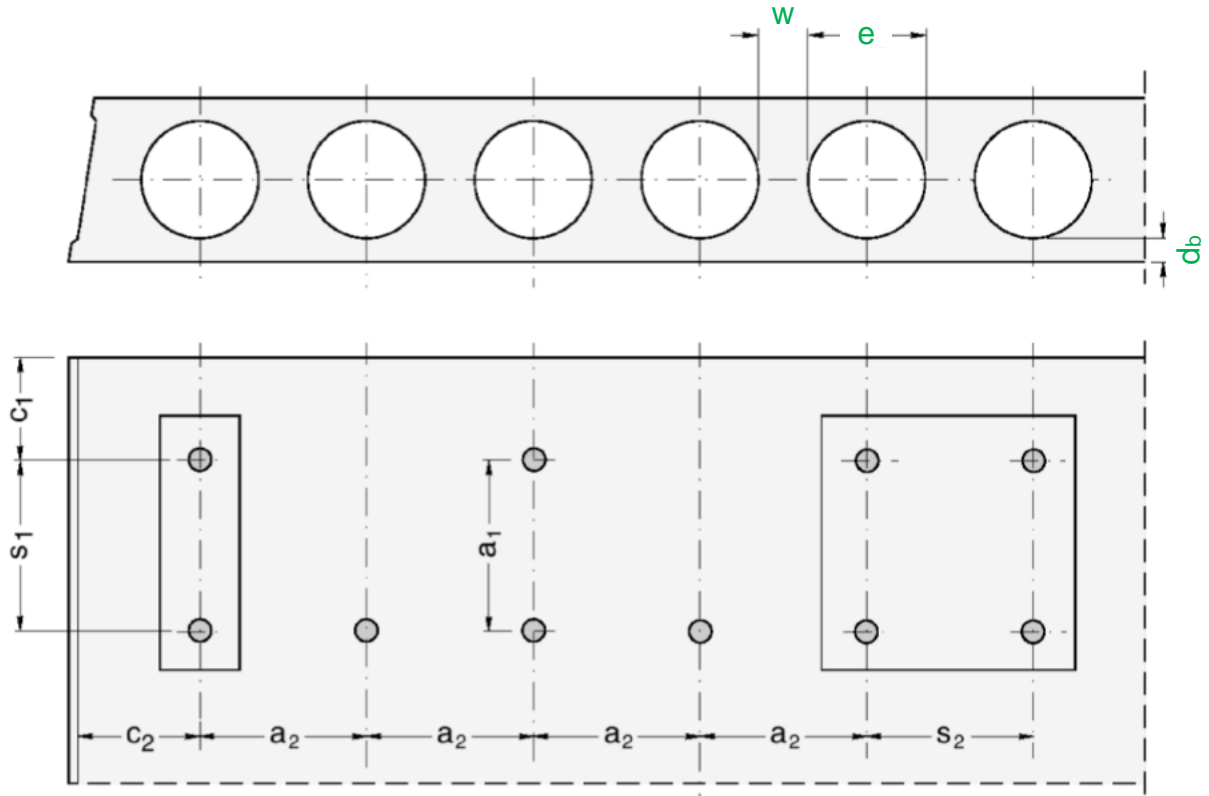

### Setting instruction

\*For detailed information on installation see instruction for use given with the package of the product.

Setting instruction		
<b>1. Drill the hole</b> 	<b>2. Insert the anchor</b> 	<b>3. Setting mark must be visible</b> 

### 3.6.10 HCA

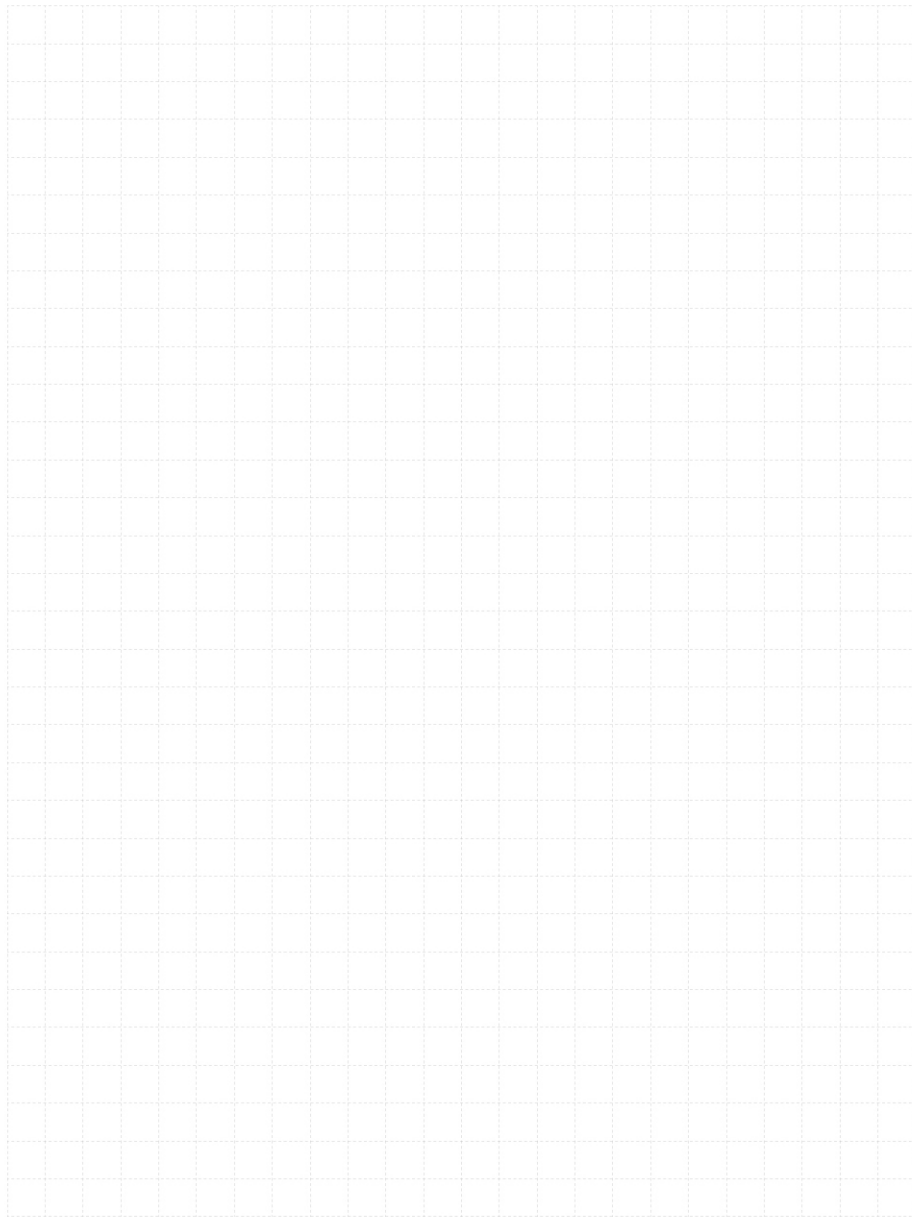

# HCA Light duty metal anchors

## Economical coil anchor

### Anchor version



HCA 5/8"

### Benefits

- Re-usable up to 140 times
- High load capacity
- Big washer  $\varnothing$  34 mm
- For temporary external applications

### Base material

 Concrete  
(non-cracked)

 Concrete  
(cracked)

### Other information

 DIBt  
Approval  
Reusability

### Approvals / certificates

Description	Authority / Laboratory	No. / date of issue
DIBt approval (reusability)	DIBt, Berlin	Z-21.8-2027 / 2019-05-15

### Basic loading data

#### For temporary application:

##### All data in this section applies to:

- Correct setting (See setting instruction)
- No edge distance and spacing influence
- Base material as specified in the table

#### For temporary application in standard and fresh concrete < 28 days old:

##### All data in this section applies to:

- Strength class,  $f_{ck,cube} \geq 10 \text{ N/mm}^2$
- Only temporary use
- Screw is reusable, before each usage it must be checked according Hilti instruction for use with the suited tube Hilti HRG
- Design resistance are valid for single anchor only
- Design resistance are valid for all load direction and valid for both cracked and non-cracked concrete
- Minimum base material thickness
- No edge distance and spacing influence

#### Design resistance for all directions in cracked and non-cracked concrete

Anchor		HCA 5/8" x 90	HCA 5/8" x 130
<b>Length in concrete</b>	$h_{nom} \geq$ [mm]	<b>80</b>	<b>115</b>
For concrete strength $\geq 10 \text{ N/mm}^2$	$F_{Rd}^{(1)}$ [kN]	4	12
For concrete strength $\geq 15 \text{ N/mm}^2$	$F_{Rd}^{(1)}$ [kN]	5	15
For concrete strength $\geq 20 \text{ N/mm}^2$	$F_{Rd}^{(1)}$ [kN]	6	18

## Materials

### Material quality

Part	Material
Anchor HCA 5/8"	Steel galvanized; $f_{uk} \geq 850 \text{ N/mm}^2$
Coil HCT	Steel galvanized; $350 \text{ N/mm}^2 \leq f_{uk} \leq 800 \text{ N/mm}^2$

### Anchor dimensions

Anchor		HCA 5/8" x 90	HCA 5/8" x 130
<b>Length in concrete</b>	$h_{nom} \geq$ [mm]	<b>80</b>	<b>115</b>
Anchor length	$l$ [mm]	90	125
Length of thread	$l_s$ [mm]	51	
Outer diameter	$d_t$ [mm]	15,8	
Core diameter	$d_k$ [mm]	13,1	
Marking for correct installation	$h_s$ [mm]	20	
Cross section	$A_s$ [mm <sup>2</sup> ]	196,1	

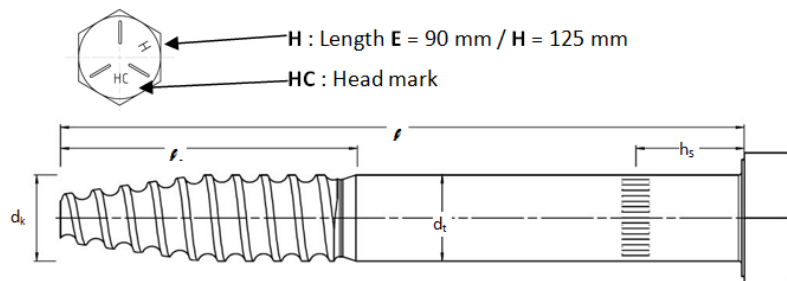

### Coil dimensions

Anchor		HCT
Anchor length	$l$ [mm]	29,3
Length of thread	$h$ [mm]	15,6

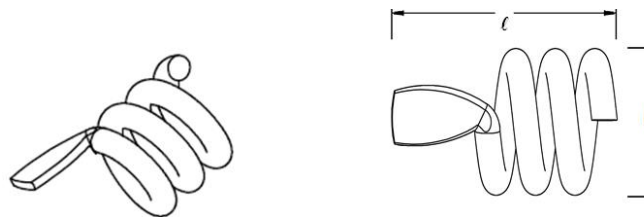

### Tube specification

Tube		HRG 16
Inner tube diameter	$\varnothing_i$ [mm]	15,1
Outer tube diameter	$\varnothing_e$ [mm]	20,0
Tube length	$L_t$ [mm]	30,0

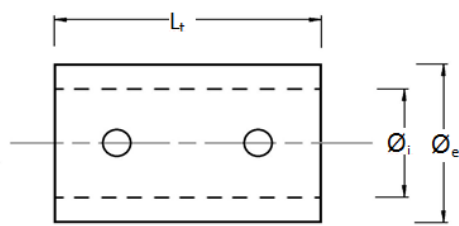

**Setting information**
**Setting details HCA**

Anchor			HCA 5/8" x 90	HCA 5/8" x 130
<b>Length in concrete</b>	$h_{nom} \geq$	[mm]	<b>80</b>	<b>115</b>
Nominal diameter of drill bit	$d_0$	[mm]	16	
Cutting diameter of drill bit	$d_{cut} \leq$	[mm]	16,5	
Diameter of clearance hole in the fixture	$d_f$	[mm]	18	
Wrench size (H-type)	SW	[mm]	24	
Thickness of fixture	$t_{fix}$	[mm]	0 ... 10	
Depth of drill hole	$h_1 \geq$	[mm]	95 - $t_{fix}$	95 - $t_{fix}$
Torque moment	$T_{min}$	[Nm]	180	

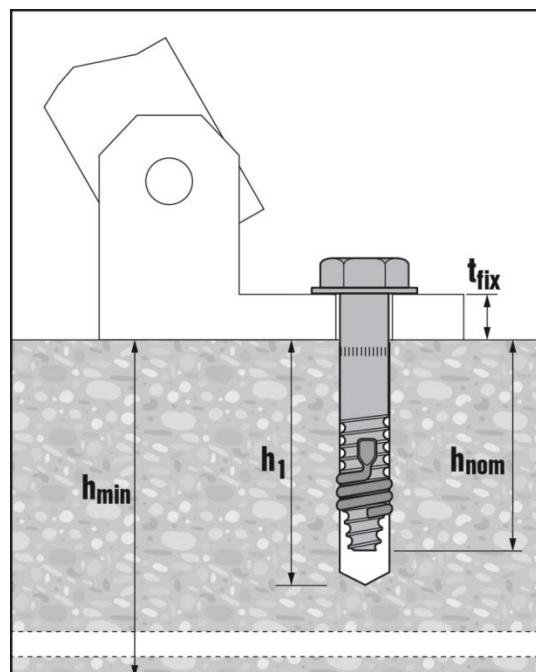
**Installation equipment**

Anchor	HCA
Rotary hammer	TE 2 – TE 80
Other tools	Hammer, torque wrench, blow out pump

**Setting parameters HCA**

Anchor			HCA 5/8" x 90	HCA 5/8" x 130
<b>Length in concrete</b>	$h_{nom} \geq$	[mm]	<b>80</b>	<b>115</b>
Minimum thickness of concrete member	$h_{min}$	[mm]	200	200
Minimum spacing	$s_{min}$	[mm]	125	550
Minimum edge distance (load direction 1)	$c_{1,min}$	[mm]	150	350
Minimum edge distance (load direction 2)	$c_{2,min}$	[mm]	200	500

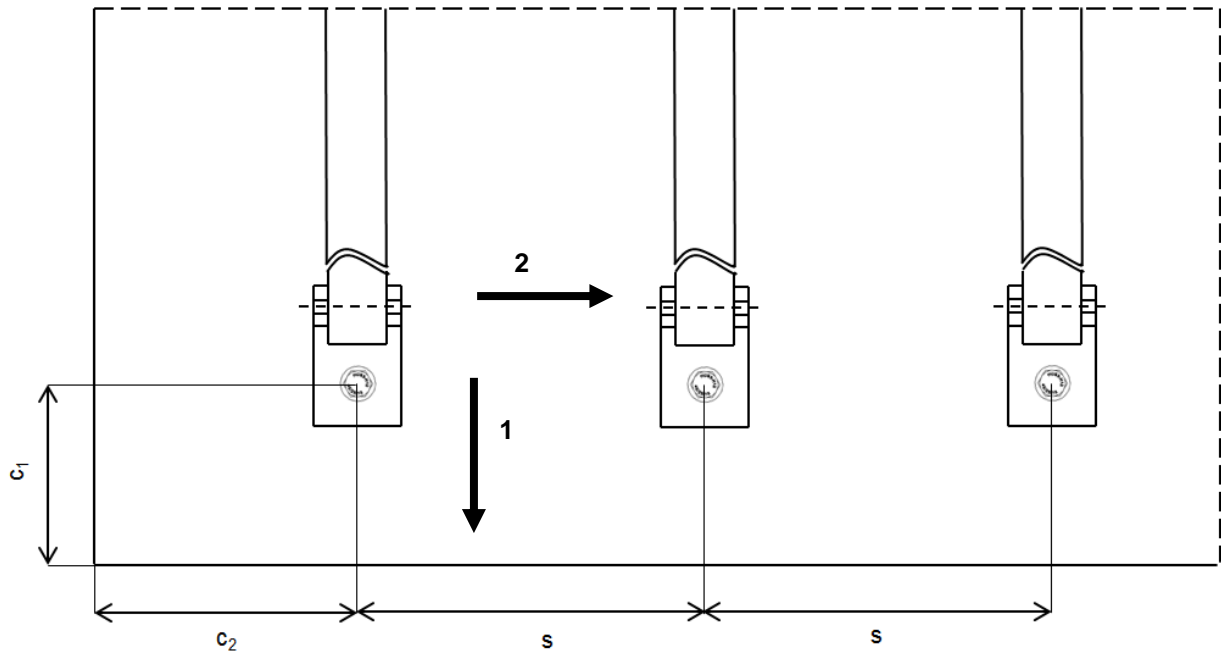

### Setting instruction

\*For detailed information on installation see instruction for use given with the package of the product.

Setting instructions	
<b>1. Drill the hole</b> 	<b>2. Cleaning</b> 
<b>3. Position coil</b> 	<b>4. Inserting the anchor</b> 
<b>5. Attaching the belonging washer</b> 	

### 3.6.11 HHD-S

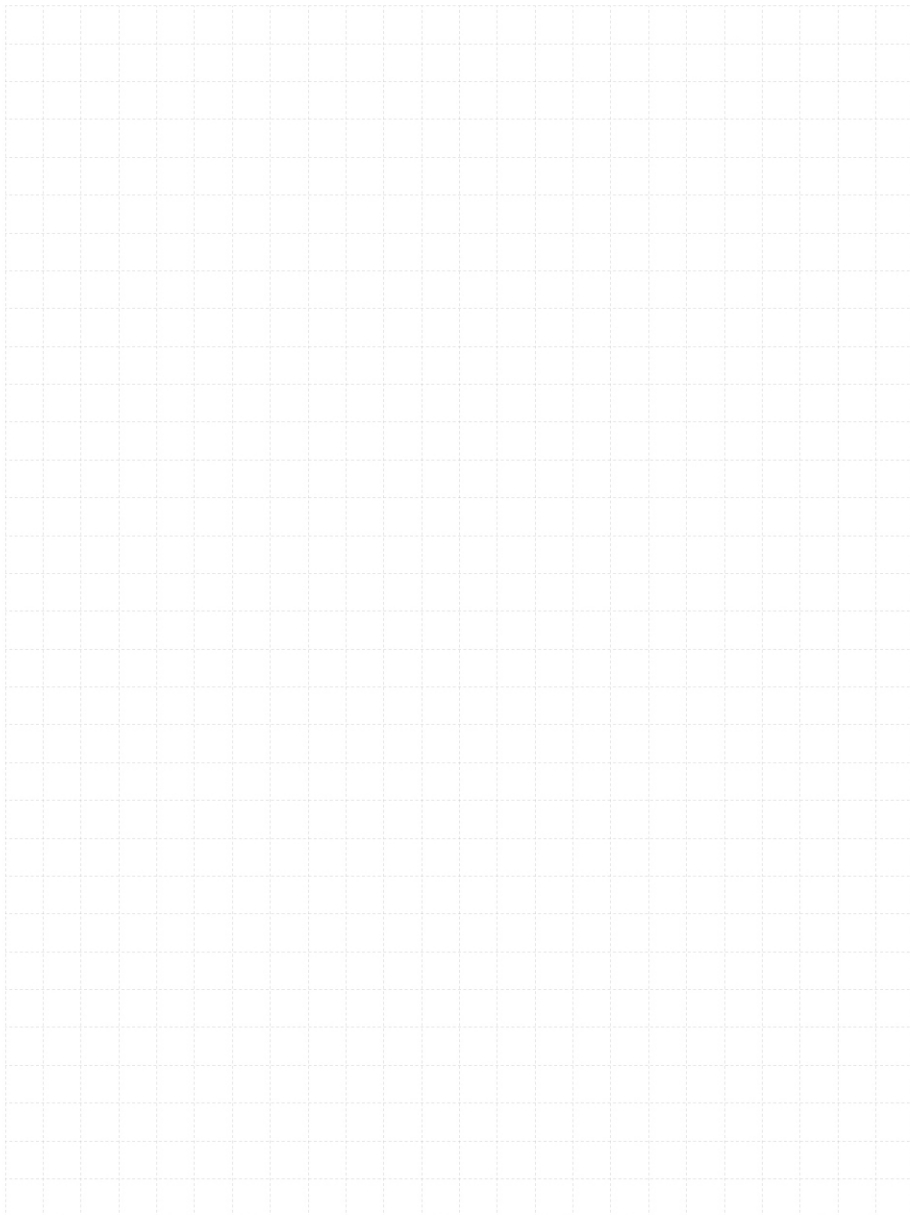

# HHD-S Light duty metal anchors

## Economical cavity anchor

### Anchor version



HHD-S  
(M4-M8)

### Benefits

- Metal undercut anchor with metric screw, especially for drywall
- Metal to metal fastening
- Reliable undercut

### Base material



Drywall

### Basic loading data (for a single anchor)

#### All data in this section applies to:

- Correct setting (See setting instruction)
- No edge distance and spacing influence
- Base material as specified in the table
- Borehole drilling without hammering

#### Recommended loads<sup>a)</sup>

Anchor size		M4	M5	M6	M8
Hollow brick web thickness 20mm	N <sub>rec</sub> [kN]	0,1	-	-	-
	V <sub>rec</sub> [kN]	0,3	-	-	-
Gypsum board Thickness 10mm	N <sub>rec</sub> [kN]	0,2	0,2	0,2	0,2
	V <sub>rec</sub> [kN]	0,5	0,5	0,5	0,5
Gypsum board Thickness 12,5mm	N <sub>rec</sub> [kN]	0,2	0,2	0,2	0,2
	V <sub>rec</sub> [kN]	0,5	0,5	0,5	0,5
Gypsum board Thickness 2x12,5mm	N <sub>rec</sub> [kN]	-	0,4	0,3	0,4
	V <sub>rec</sub> [kN]	-	1	0,9	1
Fibre reinforced gypsum board Thickness 10mm	N <sub>rec</sub> [kN]	0,2	0,3	0,25	0,4
	V <sub>rec</sub> [kN]	0,5	0,6	0,8	0,9
Fibre reinforced gypsum board Thickness 12,5mm	N <sub>rec</sub> [kN]	0,3	0,5	0,3	0,6
	V <sub>rec</sub> [kN]	0,6	1	1	1,2
Fibre reinforced gypsum board Thickness 2x12,5mm	N <sub>rec</sub> [kN]	-	0,9	0,8	0,9
	V <sub>rec</sub> [kN]	-	1,1	1,8	1,7

a) With overall global safety factor  $\gamma = 3$  to the characteristic loads and a partial safety factor of  $\gamma = 1,4$  to the design values.

### Materials

#### Material quality

Part	Material
Sleeve	Carbon steel, galvanised
Screw	Carbon steel, galvanised



## Setting information

### Setting details HHD-S

Anchor		M4x4	M4x6	M4x12	M4x19	M5x8	M5x12	M5x25
Nominal diameter of drill	$d_o$ [mm]	8	8	8	8	10	10	10
Anchor length	$l$ [mm]	20	32	38	45	38	52	65
Anchor neck length	$h$ [mm]	4	6	12,5	19	8	12,5	25
Screw length	$l_s \geq$ [mm]	25	39	45	52	45	58	71
Screw diameter	$d$ [mm]	M4	M4	M4	M4	M5	M5	M5
Panel thickness	$h_{min,max}$ [mm]	3 - 4	6 - 7	10 - 13	18 - 20	6 - 8	11 - 13	23 - 25
Max. fixable thickness for pre-setting	$t_{fix}$ [mm]	15	25	25	25	25	30	30

### Setting details HHD-S

Anchor		M6x9	M6x12	M6x24	M6x40	M8x12	M8x24	M8x40
Nominal diameter of drill	$d_o$ [mm]	12	12	12	12	12	12	12
Anchor length	$l$ [mm]	38	52	65	80	54	66	83
Anchor neck length	$h$ [mm]	9	12,5	25	40	12,5	25	40
Screw length	$l_s \geq$ [mm]	45	58	71	88	60	72	90
Screw diameter	$d$ [mm]	M6	M6	M6	M6	M8	M8	M8
Panel thickness	$h_{min,max}$ [mm]	7 - 9	11 - 13	23 - 25	38 - 40	11 - 13	23 - 25	38 - 40
Max. fixable thickness for pre-setting	$t_{fix}$ [mm]	20	30	30	30	30	30	35

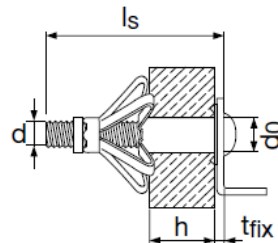

### Installation equipment

Anchor	M4	M5	M6	M8
Rotary hammer	TE2 - TE16			
Other tools	Screwdriver, HHD-SZ2 expansion tool			

## Setting instruction

\*For detailed information on installation see instruction for use given with the package of the product.

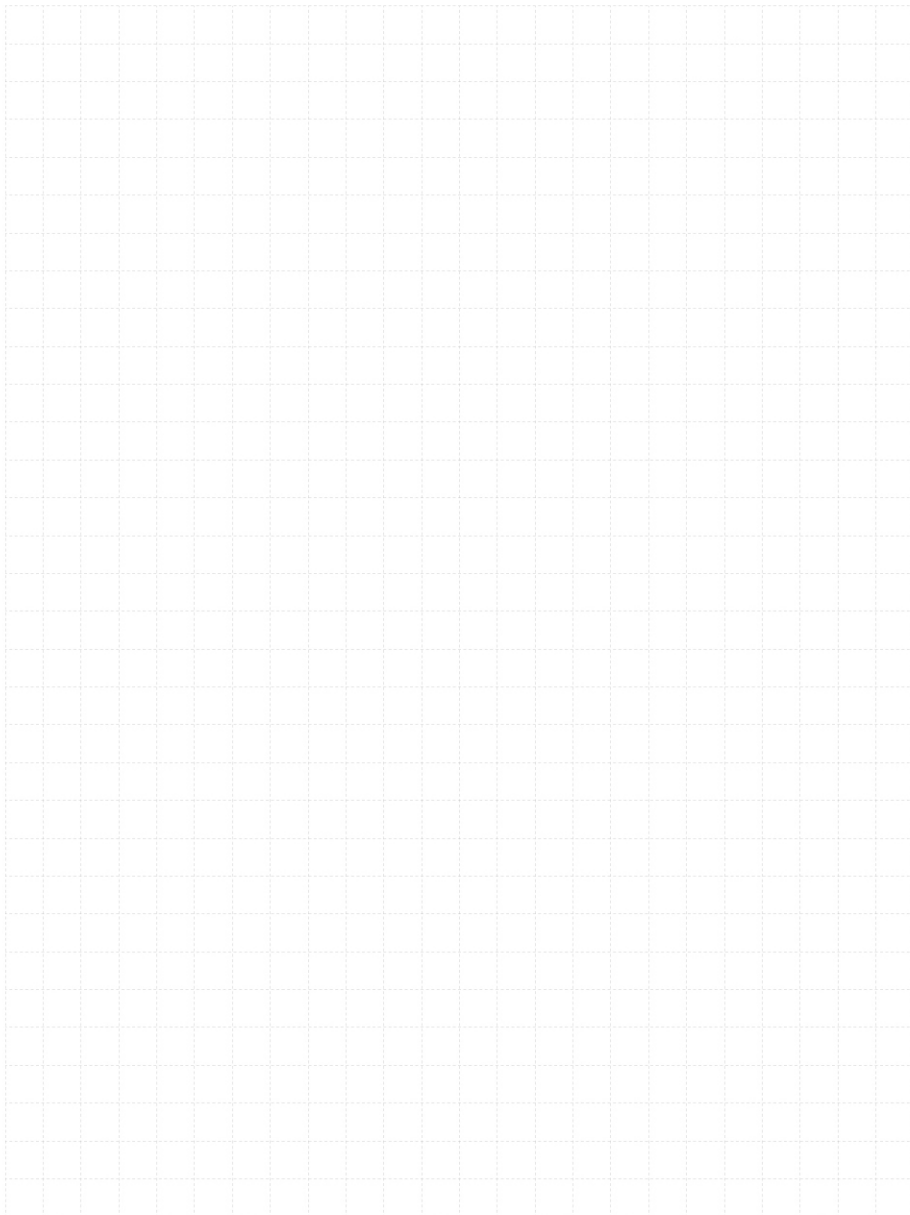

Setting instructions		
<b>1. Drill hole with drill bit</b> 	<b>2. Put anchor into setting tool</b> 	<b>3. Install anchor with setting tool</b> 
<b>4. Remove screw from anchor and screw in gain with part being fastened attached</b>		

### 3.6.12 HSP/ HFP



# HSP / HFP Light duty metal anchors

## Metal drywall anchor

Anchor version	Benefits
 HSP (-S)	- For light fastenings on drywall panel - Self-cutting - Quick setting
 HFP (-S)	

Base material
 Drywall

Basic loading data
<b>All data in this section applies to:</b> <ul style="list-style-type: none"> <li>- Correct setting (See setting instruction)</li> <li>- No edge distance and spacing influence</li> <li>- Base material as specified in the table</li> </ul>

Recommended loads <sup>a)</sup>				12,5 mm	2 x 12,5 mm
Gypsum board thickness					
Tensile	HSP (-S)	N <sub>Rec</sub>	[kN]	0,06	0,12
	HFP (-S)			0,06	0,12
Shear	HSP (-S)	V <sub>Rec</sub>	[kN]	0,18	0,27
	HFP (-S)			0,18	0,27

a) With overall global safety factor  $\gamma = 3$  to the characteristic load.

Materials	
Part	Material
HSP (-S)	Carbon steel, zincd
HFP (-S)	Polyamide, fibre reinforced
Screw	Carbon steel, galvanised to min. 5µm

**Setting information**
**Installation equipment**

Anchor	HSP (-S) / HFP (-S)
Rotary hammer	-
Other tools	Screwdriver with D-B PH2 HSP/HFP duo-bit

**Setting details HSP (-S) / HFP (-S)**

Anchor		HSP (-S)	HFP (-S)
Maximum fixture thickness	$t_{fix}$	13	13
Anchor length	$l$	37	37
Screw length	$l_s$	19 + $t_{fix}$	
Screw diameter	$d$	4,5	4,5

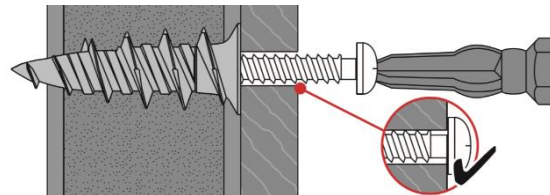
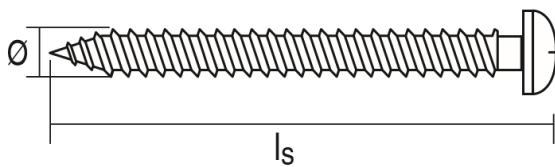

**Setting instruction**

\*For detailed information on installation see instruction for use given with the package of the product.

**Setting instructions**

Drive in plug
<p><b>1. Drive in the plug</b></p>
<p><b>2. Drive in the plug</b></p>
Fasten part and drive in screw
<p><b>3. Fasten part and drive in screw</b></p>

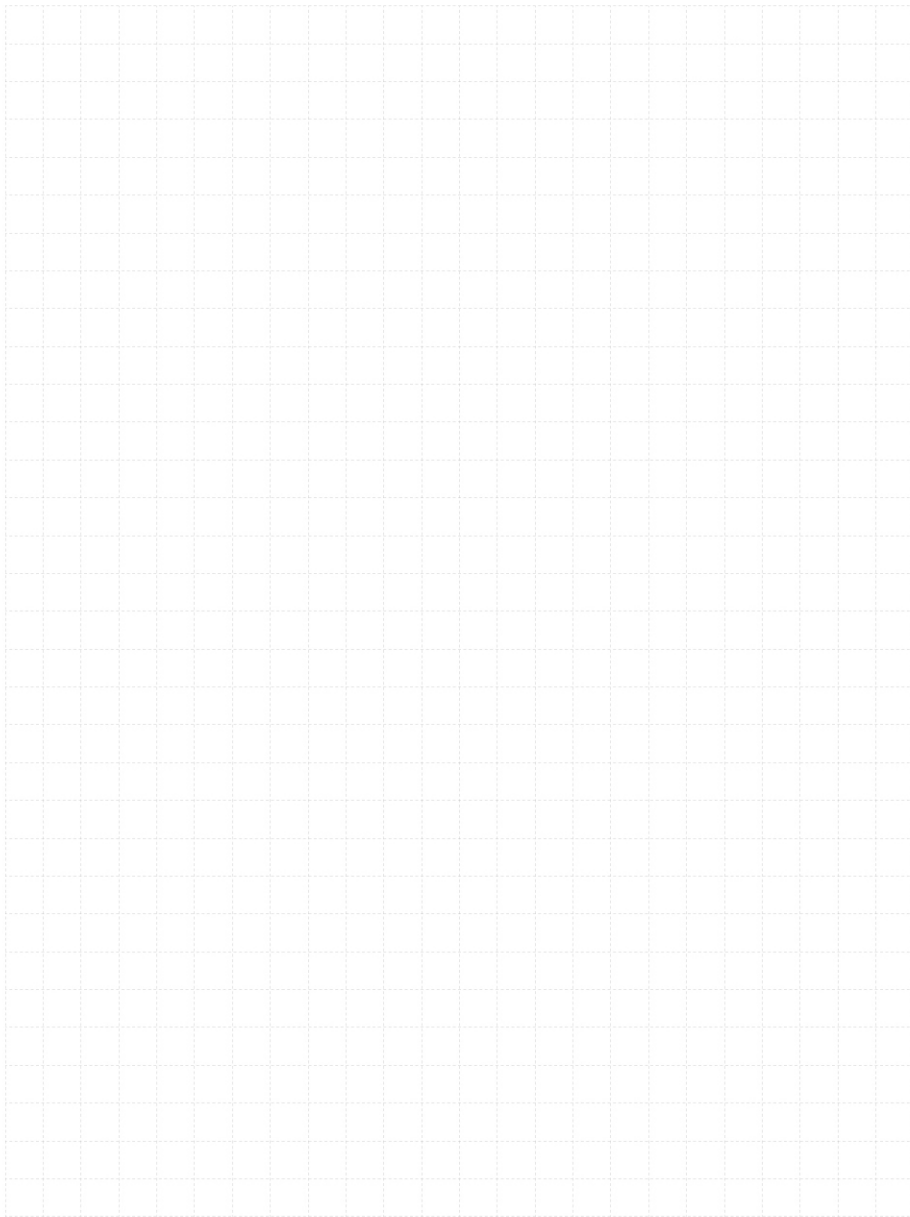
### 3.6.13 HA8 NG



# HA 8 NG Light duty metal anchors

## Hook and ring anchor

### Anchor version



HA 8 NG R1



HA 8 NG H1

### Benefits

- Well proven
- Easy-setting
- Follow-up expansion
- Hook and ring head available

### Base material

 Concrete  
(non-cracked)

### Load conditions

 Static/  
quasi-static

### Installation conditions

 Hammer  
drilled holes

### Basic loading data (for a single anchor)

#### All data in this section applies to:

- Correct setting (See setting instruction)
- No edge distance and spacing influence
- Values are only valid for tensile loading
- Concrete C20/25 ( $f_{ck,cube} = 25 \text{ N/mm}^2$ ) - C50/60 ( $f_{ck,cube} = 60 \text{ N/mm}^2$ )

Concrete			Non-cracked
Tensile	$N_{rec}$	[kN]	0,8

## Materials

Anchor size		HA 8 NG bolt
Nominal tensile strength	$f_{uk}$ [N/mm <sup>2</sup> ]	520
Yield strength	$f_{yk}$ [N/mm <sup>2</sup> ]	450

## Material quality

Part	Material
Expansion sleeve	Carbon steel, galvanized to min. 5 $\mu$ m
Bolt	Carbon steel, galvanized to min. 5 $\mu$ m

## Anchor dimensions

Anchor size		HA 8 NG
Bolt diameter	$d_R$ [mm]	5.4
Length of the anchor	$l_1$ [mm]	76

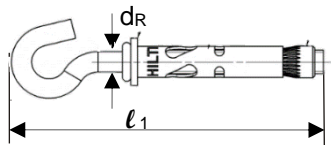

## Setting information

### Setting details

Anchor size		HA 8 NG
Nominal diameter of drill bit	$d_o$ [mm]	8
Cutting diameter of drill bit	$d_{cut} \leq$ [mm]	8,45
Depth of drill hole	$h_1 \geq$ [mm]	55
Effective anchorage depth	$h_{ef}$ [mm]	35

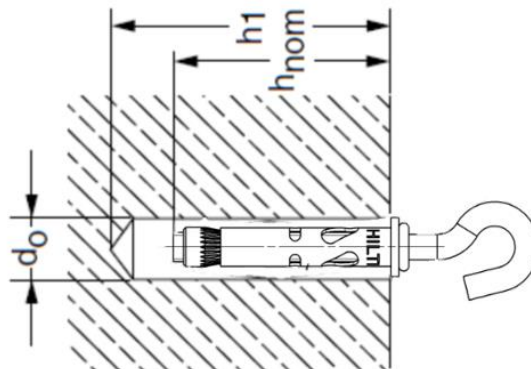

## Installation equipment

Anchor size		HA 8 NG
Rotary hammer		TE2 – TE16
Other tools		Hammer, blow out pump

### Setting parameters

Anchor size		HA 8 NG
Minimum base material thickness	$h_{min}$ [mm]	100
Minimum spacing	$s$ [mm]	200
Minimum edge distance	$c$ [mm]	100
Minimum edge distance at the corner	$c_e$ [mm]	150

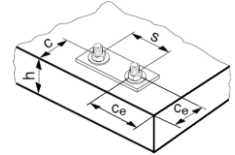

### Setting instruction

\*For detailed information on installation see instruction for use given with the package of the product.

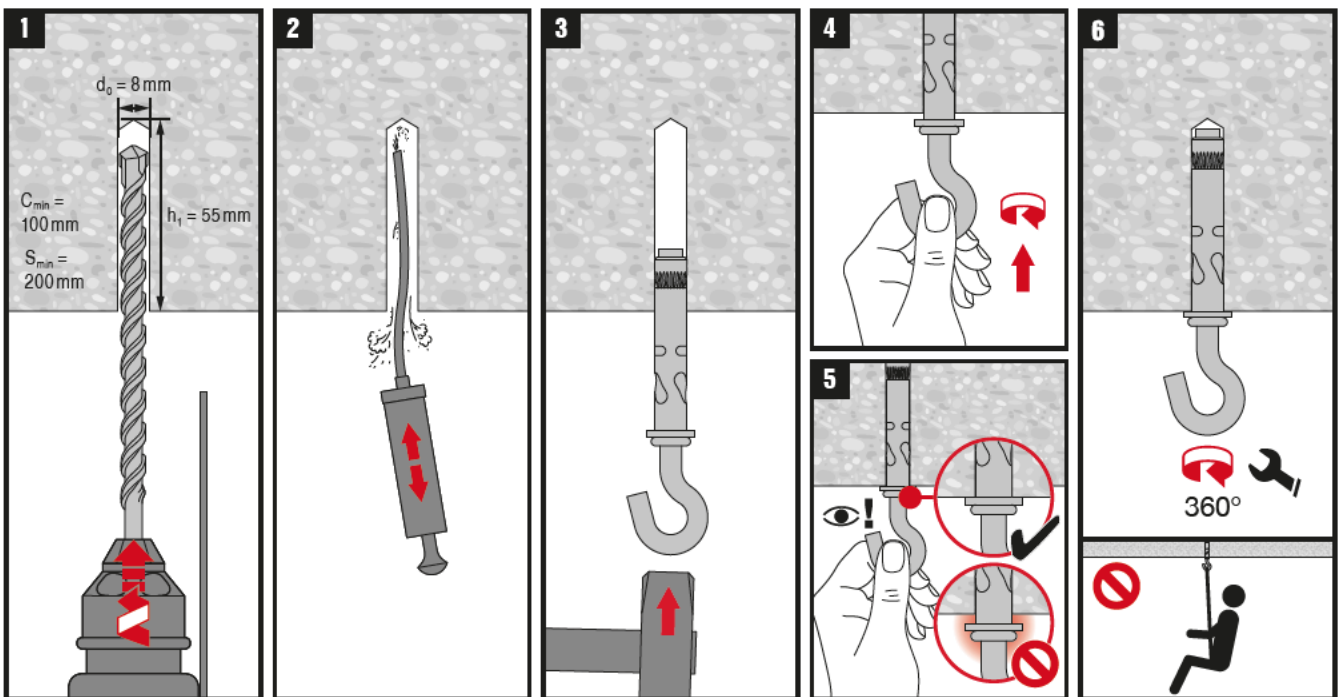



### 3.6.14 HTB 2

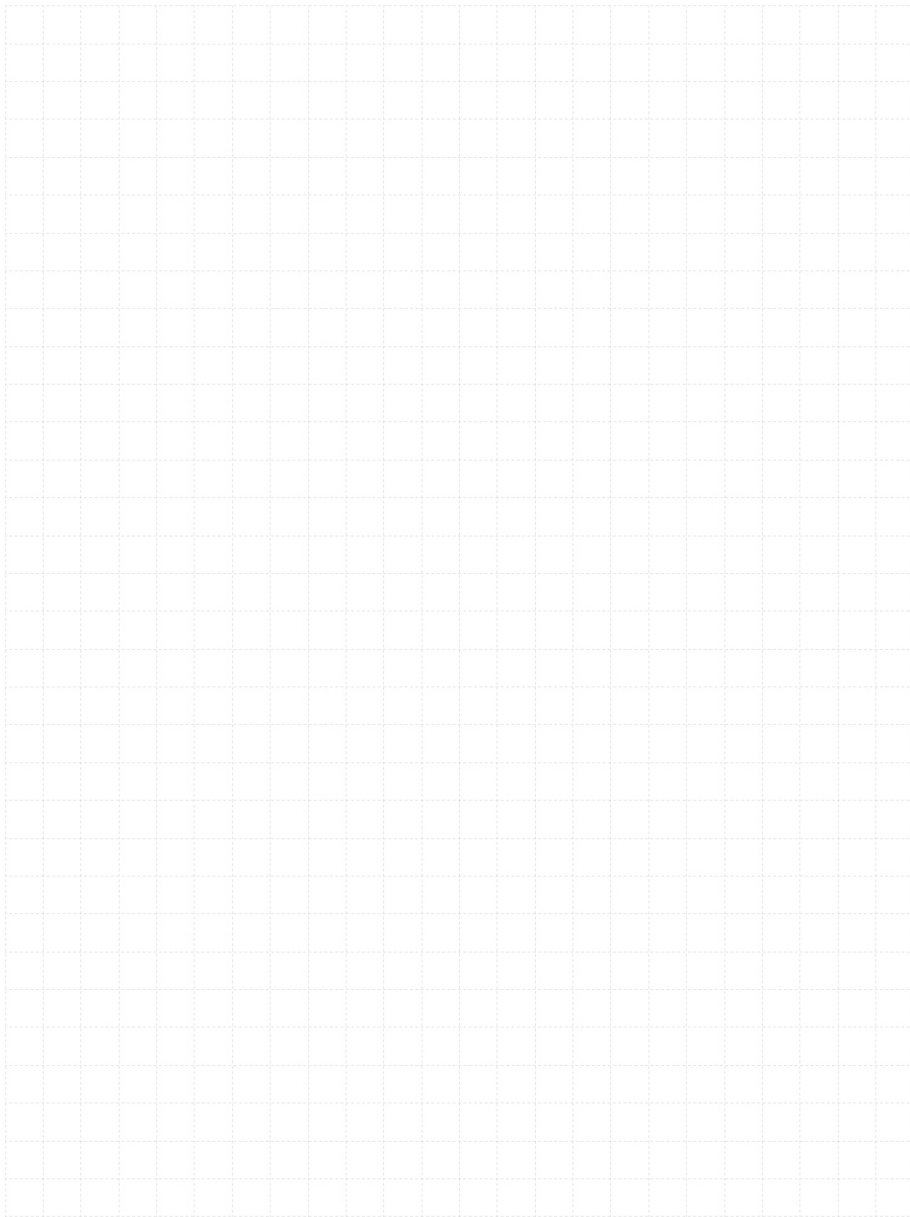

# HTB-2 Light duty metal anchors

Economical metal anchor for drywall and hollow wall

## Anchor version



HTB-2  
(M5-M6)

## Benefits

- Ingenious and strong for hollow base materials
- Convincing simplicity when setting
- Technical superiority with up to 76 mm fixing thickness
- Load carried by strong metal channel and screw

## Base material



Drywall

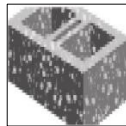

Hollow  
concrete block

## Basic loading data

All data in this section applies to:

- Correct setting (See setting instruction)
- No edge distance and spacing influence
- Base material as specified in the table
- Minimum base material thickness

## Design resistance

Anchor size		M5	M6
Gypsum board Thickness 12,5 mm	$N_{Rd}$ [kN]	0,35	
	$V_{Rd}$ [kN]	0,42	
Gypsum board Thickness 2x12,5 mm	$N_{Rd}$ [kN]	0,70	
	$V_{Rd}$ [kN]	0,42	
Fibre reinforced gypsum board Thickness 12,5 mm	$N_{Rd}$ [kN]	0,80	
	$V_{Rd}$ [kN]	0,84	
Hollow concrete block	$N_{Rd}$ [kN]	1,04	
	$V_{Rd}$ [kN]	1,3	

## Recommended loads<sup>a)</sup>

Anchor size		M5	M6
Gypsum board Thickness 12,5 mm	$N_{Rec}$ [kN]	0,25	
	$V_{Rec}$ [kN]	0,30	
Gypsum board Thickness 2x12,5 mm	$N_{Rec}$ [kN]	0,50	
	$V_{Rec}$ [kN]	0,30	
Fibre reinforced gypsum board Thickness 12,5 mm	$N_{Rec}$ [kN]	0,57	
	$V_{Rec}$ [kN]	0,60	
Hollow concrete block	$N_{Rec}$ [kN]	0,74	
	$V_{Rec}$ [kN]	0,92	

a) With overall global safety factor  $\gamma = 3$  to the characteristic loads and a partial safety factor of  $\gamma = 1,4$ , to the design values.

**Materials**
**Material quality**

Part	Material
Metal channel	Carbon steel galvanized to 5 microns
Cap washer	Polypropylene copolymer
Legs	Polypropylene copolymer
Screw	Carbon steel galvanized to 3 microns

**Setting information**
**Setting details**

Anchor size		M5	M6
Nominal diameter of drill bit	$d_0$ [mm]	13	
Thickness of wall and fixture	min $h + t_{fix}$ [mm]	10	
	max $h + t_{fix}$ [mm]	76	
Minimum space of cavity	$l$ [mm]	60	
Screw length	$l$ [mm]	$12 + h + t_{fix}$	
Screw size	$d$ [Nm]	M5	M6
Torque moment	$T_{inst}$ [mm]	3	5

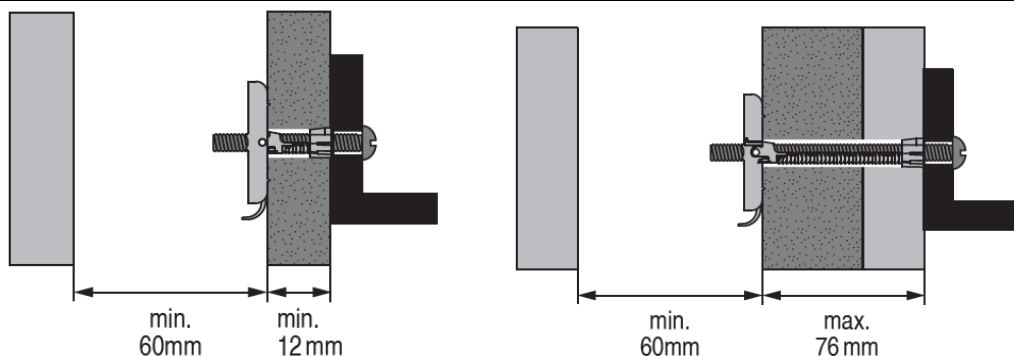
**Installation equipment**

Anchor size	M5	M6
Rotary hammer	TE 6A, TE 6C, TE 6S, TE 15, TE 15-C, TE 18-M	
Setting tools	Screw driver	

**Setting instruction**

\*For detailed information on installation see instruction for use given with the package of the product.

Setting instruction		
<b>1. Drilling</b> 	<b>2. Prepare anchor for inserting</b> 	<b>3. Inserting and adjusting anchor</b> 
<b>4. Throw away removable part</b> 	<b>5. Inserting screw with tool</b> 	

## 3.7 Anchor for insulation

### 3.7.1 HIF

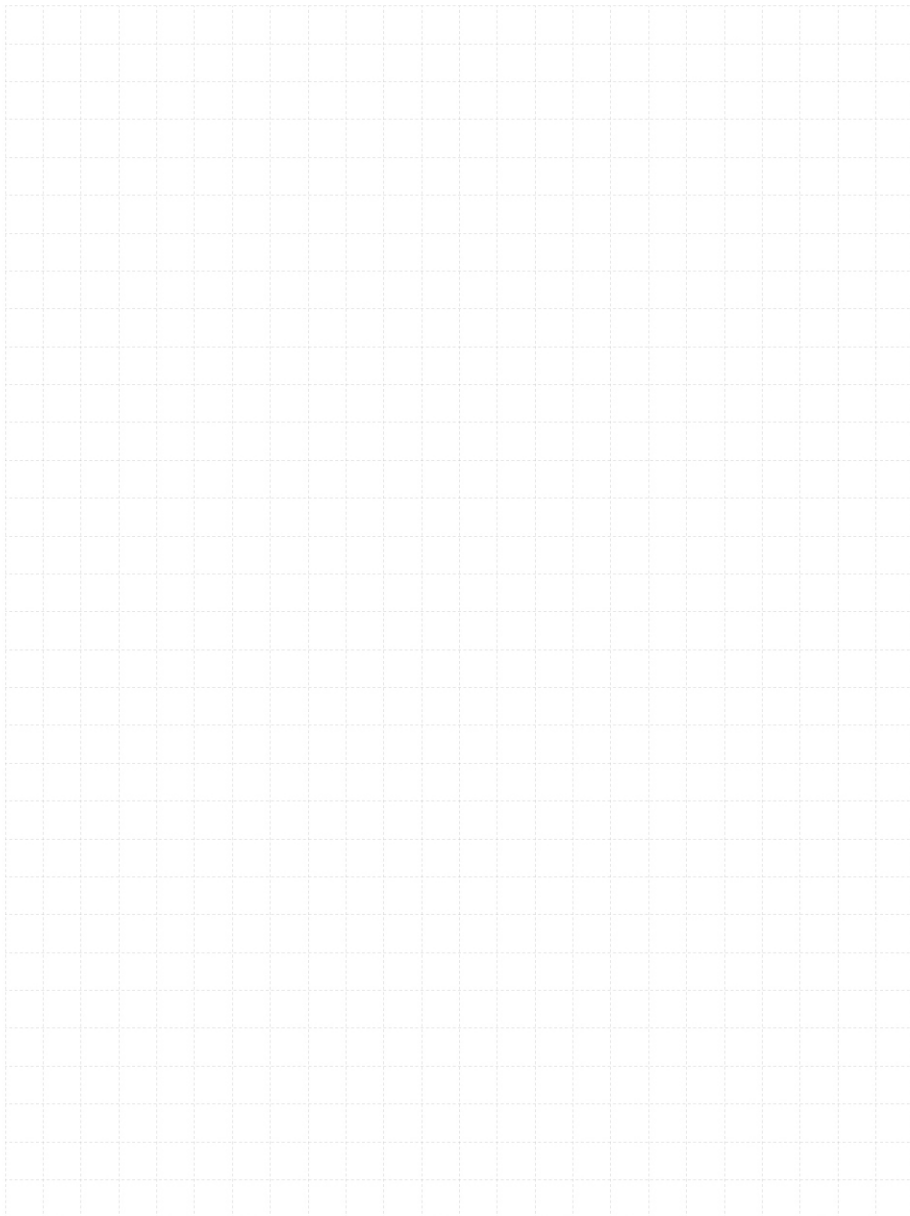

# HIF Insulation fastener

## Anchor version



HIF

## Benefits

- Especially for soft insulation material
- Plate diameter 90mm is ideal not to sink in the surface
- No slip-on plate must be used
- Drilling, hammering, done
- Speed due to less drilling effort
- With anchors up to 240mm insulation thickness the whole application is covered

## Base material



Concrete  
(non-cracked)

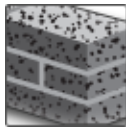

Solid brick

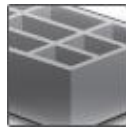

Hollow brick

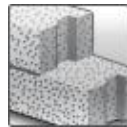

Autoclaved  
aerated  
concrete

## Other information



Fastening of  
insulation at the  
wall only

### Basic loading data (for a single anchor)

#### All data in this section applies to:

- Correct setting (see setting instruction)
- No edge distance and spacing influence
- Base material as specified in table
- Minimum base material thickness or greater
- Tensile loads only
- Anchor and its plate is not exposed to UV-radiation for more than 6 weeks

#### Anchorage depth

Anchor			HIF
Overall plastic anchor embedment depth in the base material	$h_{nom} \geq$	[mm]	25

#### Recommended loads

Base material			HIF
Concrete $\geq$ C16/20	$N_{Rec}$	[kN]	0,03
Solid clay brick Mz 20 – 1,8 – NF	$N_{Rec}$	[kN]	0,03
Solid sand-lime brick KS 12 – 1,6 – 2DF	$N_{Rec}$	[kN]	0,03
Hollow clay brick <sup>c)</sup> Hlz 12 – 0,8 – 6DF	$N_{Rec}$	[kN]	0,025 <sup>b)</sup>
Hollow sand-lime brick <sup>c)</sup> KSL 12 – 1,4 – 3DF	$N_{Rec}$	[kN]	0,03
Autoclaved aerated concrete AAC 4	$N_{Rec}$	[kN]	0,015 <sup>b)</sup>

a) Recommended loads  $N_{Rec}$  are based on a global safety factor  $\gamma = 3$  to the characteristic resistance. Design resistance  $N_{Rd}$  can be derived by multiplying  $N_{Rec}$  with a partial safety factor of  $\gamma_F = 1,5$ .

b) Drilling without hammer action

c) Thickness of web for Hlz  $\geq$  18mm, for KSL  $\geq$  25mm

## Additional technical parameters

### Point thermal transmittance

Base material	HIF	
Point thermal transmittance	$\chi$ [W/K]	0,000 <sup>a)</sup>

a) According EOTA Technical Report TR 025

### Fire classification

According to	Classification
DIN 4102	B2
EN 13501-1	E-d2

## Materials

### Material quality

Part	Material
Anchor shaft and anchor plate	Polypropylene

## Setting information

### Installation temperature range:

0°C to +40°C

### Service temperature range

Hilti HIF insulation fastener may be applied in the temperature ranges given below.

### Service temperature range

Temperature range	Base material temperature	Maximum long term base material temperature	Maximum short term base material temperature
Temperature range	-40 °C to +40 °C	+24 °C	+40 °C

### Maximum short term base material temperature

Short-term elevated base material temperatures are those that occur over brief intervals, e.g. because of diurnal cycling.

### Maximum long term base material temperature

Long-term elevated base material temperatures are roughly constant over significant periods of time.

**The anchor shall not be exposed to UV-radiation for more than 6 weeks**

**Setting details**

HIF		60	80	100	120	140	160	180	200	220	240
Nominal diameter of drill bit	$d_0$ [mm]	8									
Cutting diameter of drill bit	$d_{cut} \leq$ [mm]	8,45									
Depth of drill hole	$h_1 \geq$ [mm]	$L_a - l_D + 5 \geq 30\text{mm}$									
Overall plastic anchor embedment depth in the base material	$h_{nom} \geq$ [mm]	25									
Anchor length	$L_a$ [mm]	85	105	125	145	165	185	205	225	245	265
Fixture thickness	$l_D$ [mm]	40-60	60-80	80-100	100-120	120-140	140-160	160-180	180-200	200-220	220-240

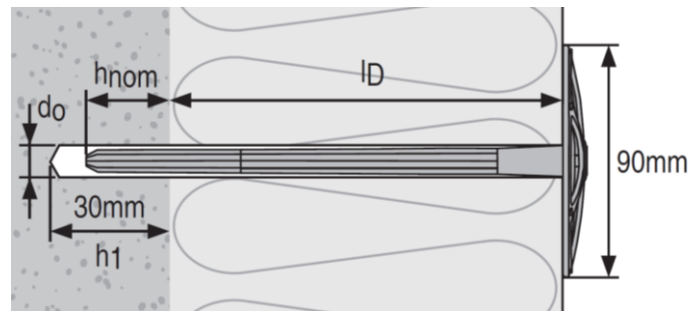
**Setting parameters**

HIF		60	80	100	120	140	160	180	200	220	240
Minimum base material thickness	$h_{min}$ [mm]	100									
Minimum spacing	$s_{min}$ [mm]	100									
Minimum edge distance	$c_{min}$ [mm]	100									

**Installation equipment**

Anchor size	HIF
Rotary hammer	Corded: HILTI TE 2 – TE 7 Battery: HILTI TE2-A22, TE4-A22, TE6-A36
Other tools	Hammer

**Setting instruction\***

\*For detailed information on installation see instruction for use given with the package of the product.

Setting instructions	
<b>1. Drill hole with drill bit</b> 	<b>2. Tap fastener with a hammer</b> 
<b>3. Check correct setting</b> 	



### 3.7.2 HTH

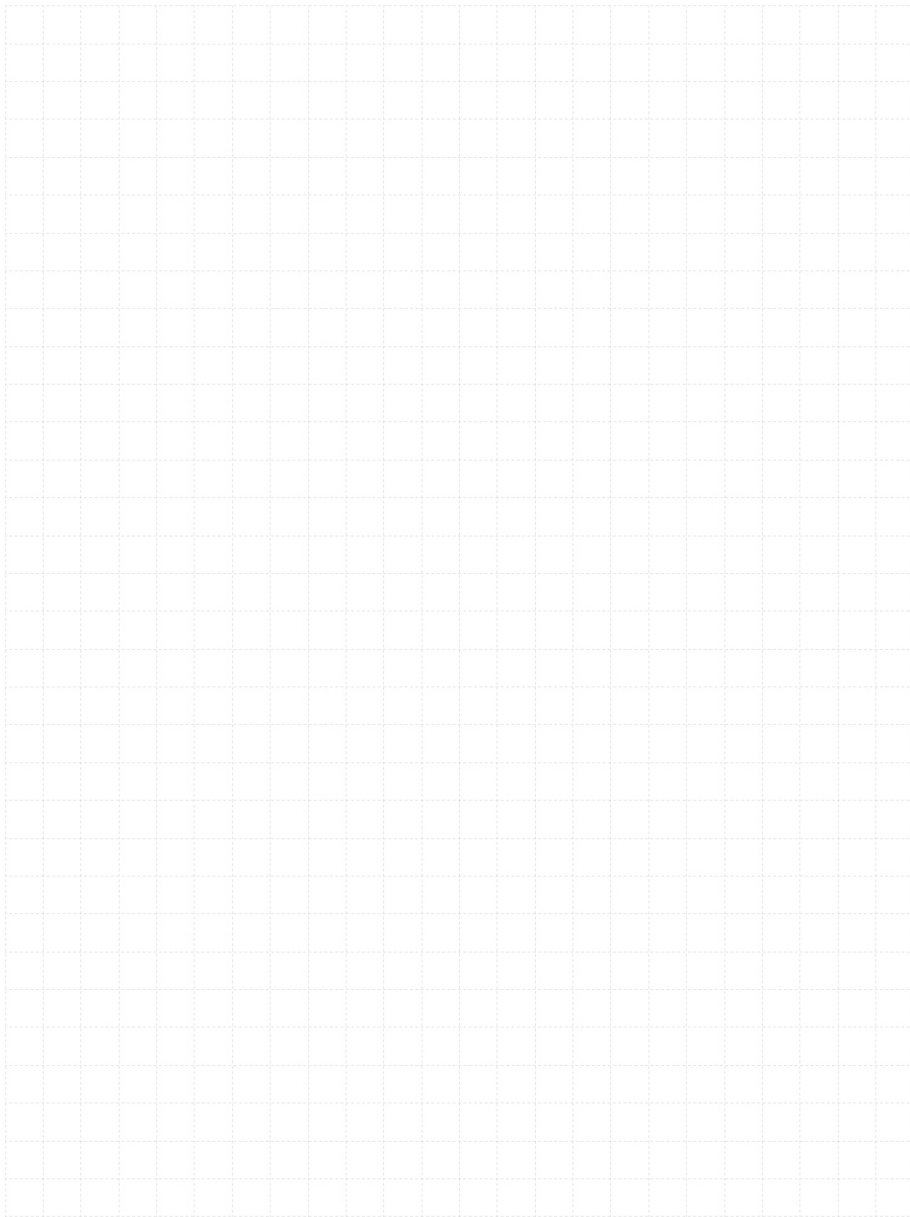

# HTH Insulation fastener

## Anchor version



HTH

## Benefits

- Fastening in all base materials of category A, B, C, D and E
- Setting tool for fast and safe application
- Lowest heat transmission (chi-value up to 0.000 W/K)
- One anchor size fits all insulation thickness

## Base material



Concrete (non-cracked)

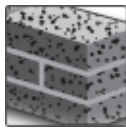

Solid brick

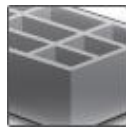

Hollow brick

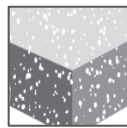

Lightweight Aggregate concrete

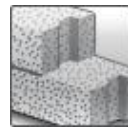

Autoclavated Aerated concrete

## Other information

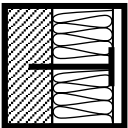

Fastening of insulation at the wall only



European Technical Assessment



CE conformity

## Approvals/Certificates

Description	Authority / Laboratory	No. / date of issue
European Technical Assessment <sup>a)</sup>	DIBt, Berlin	ETA-15/0464 / 2018-01-11
Application in External Thermal Insulation Composite Systems with Rendering <sup>a)</sup>	DIBt, Berlin	Z-21.2-2047 / 2018-04-13

a) Unless otherwise stated, all data given in this section are according to named documents

**Basic loading data (for a single anchor)**
**All data in this section applies to:**

- Correct setting (see setting instruction)
- No edge distance and spacing influence
- Base material as specified in table
- Minimum base material thickness
- Transmission of wind suction loads only

**Anchorage depth**

Anchor	Use category		HTH
Overall plastic anchor embedment depth in the base material	A, B, C	$h_{nom} \geq$ [mm]	25
	D, E		55

**Characteristic resistance**

Base material	Use category <sup>d)</sup>		HTH
Concrete $\geq$ C12/15	A	$N_{Rk}$ [kN]	1,2
Thin concrete members (e.g. weather resistant skins of external wall panels) C16/20 – C 50/60	A	$N_{Rk}$ [kN]	1,2
Solid clay brick Mz 20/2,0	B	$N_{Rk}$ [kN]	1,2
Solid sand-lime brick KS 20/2,0	B	$N_{Rk}$ [kN]	1,2
Vertically perforated clay brick Hlz 12/1,2	C	$N_{Rk}$ [kN]	1,2 <sup>a)</sup>
Vertically perforated clay brick Hlz 12/0,8	C	$N_{Rk}$ [kN]	0,6 <sup>b)</sup>
Vertically perforated sand-lime brick KSL 12/1,4	C	$N_{Rk}$ [kN]	1,2 <sup>c)</sup>
Lighweight Aggregate Concrete $\geq$ LAC2 (raw density $\geq$ 0,9 kg/dm <sup>3</sup> )	D	$N_{Rk}$ [kN]	0,6
Lighweight Aggregate Concrete $\geq$ LAC4 (raw density $\geq$ 0,9 kg/dm <sup>3</sup> )	D	$N_{Rk}$ [kN]	1,2
Autoclaved aerated concrete $\geq$ PP4 (raw density $\geq$ 0,5 kg/dm <sup>3</sup> )	E	$N_{Rk}$ [kN]	0,9

a) The value applies only for outer web thickness  $\geq$  12 mm, rotary drilling only

b) The value applies only for outer web thickness  $\geq$  9 mm, rotary drilling only

c) The value applies only for outer web thickness  $\geq$  23 mm, rotary drilling only

d) Different installation parameters for use categories A, B, C and use categories D, E and thin concrete members to be considered

**Design resistance <sup>e)</sup>**

Base material	Use category <sup>d)</sup>		HTH
Concrete $\geq$ C12/15	A	$N_{Rd}$ [kN]	0,6
Thin concrete members (e.g. weather resistant skins of external wall panels) C16/20 – C 50/60	A	$N_{Rd}$ [kN]	0,6
Solid clay brick Mz 20/2,0	B	$N_{Rd}$ [kN]	0,6
Solid sand-lime brick KS 20/2,0	B	$N_{Rd}$ [kN]	0,6
Vertically perforated clay brick Hlz 12/1,2	C	$N_{Rd}$ [kN]	0,6 <sup>a)</sup>
Vertically perforated clay brick Hlz 12/0,8	C	$N_{Rk}$ [kN]	0,3 <sup>b)</sup>
Vertically perforated sand-lime brick KSL 12/1,4	C	$N_{Rd}$ [kN]	0,6 <sup>c)</sup>
Lightweight Aggregate Concrete $\geq$ LAC2 (raw density $\geq$ 0,9 kg/dm <sup>3</sup> )	D	$N_{Rd}$ [kN]	0,3
Lightweight Aggregate Concrete $\geq$ LAC4 (raw density $\geq$ 0,9 kg/dm <sup>3</sup> )	D	$N_{Rd}$ [kN]	0,6
Autoclaved aerated concrete $\geq$ PP4 (raw density $\geq$ 0,5 kg/dm <sup>3</sup> )	E	$N_{Rd}$ [kN]	0,45

a) The value applies only for outer web thickness  $\geq$  12 mm, rotary drilling only

b) The value applies only for outer web thickness  $\geq$  9 mm, rotary drilling only

c) The value applies only for outer web thickness  $\geq$  23 mm, rotary drilling only

d) Different installation parameters for use categories A, B, C and use categories D, E and thin concrete members to be considered

e) Design resistance calculated acc.to formula  $N_{Rd} = N_{Rk} / \gamma_M$  with  $\gamma_M = 2,0$

**Recommended loads <sup>e)</sup>**

Base material	Use cat. <sup>d)</sup>		HTH
Concrete $\geq$ C12/15	A	$N_{Rec}$ [kN]	0,4
Thin concrete members (e.g. weather resistant skins of external wall panels) C16/20 – C 50/60	A	$N_{Rec}$ [kN]	0,4
Solid clay brick Mz 20/2,0	B	$N_{Rec}$ [kN]	0,4
Solid sand-lime brick KS 20/2,0	B	$N_{Rec}$ [kN]	0,4
Vertically perforated clay brick Hlz 12/1,2	C	$N_{Rec}$ [kN]	0,4 <sup>a)</sup>
Vertically perforated clay brick Hlz 12/0,8	C	$N_{Rec}$ [kN]	0,2 <sup>b)</sup>
Vertically perforated sand-lime brick KSL 12/1,4	C	$N_{Rec}$ [kN]	0,4 <sup>c)</sup>
Lightweight Aggregate Concrete $\geq$ LAC2 (raw density $\geq$ 0,9 kg/dm <sup>3</sup> )	D	$N_{Rec}$ [kN]	0,2
Lightweight Aggregate Concrete $\geq$ LAC4 (raw density $\geq$ 0,9 kg/dm <sup>3</sup> )	D	$N_{Rec}$ [kN]	0,4
Autoclaved aerated concrete $\geq$ PP4 (raw density $\geq$ 0,5 kg/dm <sup>3</sup> )	E	$N_{Rec}$ [kN]	0,3

a) The value applies only for outer web thickness  $\geq$  12 mm, rotary drilling only

b) The value applies only for outer web thickness  $\geq$  9 mm, rotary drilling only

c) The value applies only for outer web thickness  $\geq$  23 mm, rotary drilling only

d) Different installation parameters for use categories A, B, C and use categories D, E and thin concrete members to be considered

e) Recommended loads calculated acc.to formula  $N_{Rec} = N_{Rd} / \gamma_f$  with  $\gamma_f = 1,5$

**Additional technical parameters**
**Insulation Materials**

Insulation material and provider	Specifying document	Referenced document for anchor design	Design provisions <sup>a)</sup>	Anchor design
EPS with designation key T2 L2 W2 S2 P4 BS50 DS(70)5-DS(N)2 a) TR80 raw density 15-20 kg/m <sup>3</sup> ; b) TR100 raw density 15-30 kg/m <sup>3</sup>	DIN EN 13163	Z-21.2-2047 April 13 <sup>th</sup> 2018, DIBt	ETICS fixed with anchor and supplementary adhesive Panels 100mm to 360mm thick	see next pages <sup>b)</sup>
Coverrock, Coverrock II and Coverrock 036 by Deutsche Rockwool Mineralwoll GmbH	Z-33.4-1571, October 14 <sup>th</sup> 2016, DIBt			
Sillatherm WVP 1-035 by SAINT-GOBAIN ISOVER G+H AG	Z-33.4-1081, Oct. 14 <sup>th</sup> 2016, DIBt			
Mineral wool FKD-MAX C1/C2 by Knauf Insulation GmbH	Anwendungs-dokument <sup>b)</sup>	Anwendungs-dokument <sup>c)</sup>	ETICS fixed with anchor and supplementary adhesive Panels 100mm to 200mm thick	see next pages
Mineral wool FKD-S C2 by Knauf Insulation GmbH	ÖNorm B6000:2017	B6400-1, September 2017		Systemklasse 3
Mineral wool PAROC FAS 3cc by PAROC GmbH				
Mineral wool ROCKWOOL PT A 036 by ROCKWOOL Handelsgesellschaft m.b.H.				

- a) Design provisions of this table refer to the referenced documents for anchor design. National provisions of other countries might be different and must be considered.
- b) In Germany: Design provisions of German ETICS-approval Z-33.43-xxxx must be considered, too. The less unfavourable design of Z-21.2-2047 and Z-33.43-xxxx is applicable.
- c) Application document Mineral wool insulation material according to EN 16262 for use in external thermal insulation composite systems (ETICS), Knauf Insulation plaster base board FKD-MAX C1, Knauf Insulation plaster base board FKD-MAX C2, Knauf Insulation GmbH, November 2017.

In absence of national provisions, HTH can be used for ETICS with mineral wool if the following provisions are kept:

- minimum 4 anchors/m<sup>2</sup>
- only ETICS fixed with anchors and supplementary adhesive
- only ETICS that hold an ETA or National approval
- Mineral wool of TR5 or greater
- Mineral wool of 100mm to 300mm thickness
- Rendering weight ≤ 48 kg/m<sup>2</sup>
- Characteristic pull-through resistance of the mineral wool in combination with HTH has to be determined by tests
- Design of anchor number/m<sup>2</sup> must be done based on characteristic pull-through resistance and pull-out resistance by an engineer experienced in anchor design

**Number of anchors based on design wind resistance  $w_{ed}=w_e \cdot \gamma_F$  for different insulation panels and base material categories A, B, C, D, E <sup>a) b) c)</sup>**

Design load of wind $w_{ed}$ [kN/m <sup>2</sup> ] <sup>e)</sup>				Number of anchors per m <sup>2</sup>	Anchor pattern <sup>f)</sup>
EPS TR80	EPS TR100	Coverrock, Coverrock II and Coverrock 036	Sillatherm WVP 1-035		
Panel size: 1000mm x 500mm		Panel size: 800mm x 625mm			
≤ 1,2	≤ 1,3	≤ 0,6	≤ 0,3	4	
≤ 1,7	≤ 1,9	≤ 0,8	≤ 0,4	6	
≤ 2,2	≤ 2,4	≤ 1,1	≤ 0,6	8	
≤ 2,6	≤ 2,9	≤ 1,2	≤ 0,7	10	
≤ 3,0	≤ 3,3	≤ 1,4	-	12	
-	-	≤ 1,5	-	14	

- a) The design of anchorages must be carried out in accordance to ETAG 014 and ETAG 004 under the responsibility of an engineer experienced in anchorages.
- b) The table considers a safety factor for the base material of  $\gamma_{M,BM}=2,0$ , for EPS  $\gamma_{M,EPS}=1,5$ , and for mineral wool  $\gamma_{M,MW}=2,0$ .
- c) All base materials given in tables before are covered. In case that the characteristic resistance is determined by job site tests, the number of anchors is determined by the greater number in the table and  $n = w_{ed}/(N_{rk,jobstest}/\gamma_{M,BM})$ , where  $N_{rk,jobstest}$ =characteristic resistance determined by job site tests and  $\gamma_{M,BM}=2,0$  (in absence of national safety factors). The number n shall be rounded upwards to an integer number.
- d) DIBt letter November 13<sup>th</sup>, 2017 lays out that ETICS anchor approvals do cover wind resistances only. Effects caused by ETICS' weight and hygrothermal influences are not considered. In every case the ETICS approval must be considered.
- e)  $w_{ed}=w_e \times \gamma_F$  where  $w_e$ =characteristic external wind suction according EN 1991-1-4:2005-04 and national appendixes. Safety factor for wind  $\gamma_F=1,5$ .
- f) The application of the indicated anchor pattern pre-assumes that the anchors are set with a distance  $\geq 150$ mm to the edge of the panels

**Number of anchors based on design wind loads  $w_e$  for different insulation panels and base material categories A, B, C, D, E <sup>a) b) c) d)</sup>**

wind load $w_{ed}$ [kN/m <sup>2</sup> ] <sup>e)</sup>				Number of anchors per m <sup>2</sup>	Anchor pattern <sup>f)</sup>
EPS TR80	EPS TR100	Coverrock, Coverrock II and Coverrock 036	Sillatherm WVP 1-035		
Panel size: 1000mm x 500mm		Panel size: 800mm x 625mm			
≤ 0,80	≤ 0,87	≤ 0,40	≤ 0,20	4	
≤ 1,13	≤ 1,27	≤ 0,53	≤ 0,27	6	
≤ 1,47	≤ 1,60	≤ 0,73	≤ 0,40	8	
≤ 1,73	≤ 1,93	≤ 0,80	≤ 0,47	10	
≤ 2,00	≤ 2,20	≤ 0,93	-	12	
-	-	≤ 1,00	-	14	

- a) The design of anchorages must be carried out in accordance to ETAG 014 and ETAG 004 under the responsibility of an engineer experienced in anchorages.
- b) The table considers a safety factor for the base material of  $\gamma_{M,BM}=2,0$ , for EPS  $\gamma_{M,EPS}=1,5$ , for mineral wool  $\gamma_{M,MW}=2,0$  and for wind action  $\gamma_F=1,5$
- c) All base materials given in tables before are covered. In case that the characteristic resistance is determined by job site tests, the number of anchors is determined by the greater number in the table and  $n = w_e / (N_{rk,job\ site} / (\gamma_{M,BM} \times \gamma_F))$ , where  $N_{rk,job\ site}$ =characteristic resistance determined by job site tests,  $\gamma_{M,BM}=2,0$  and  $\gamma_F=1,50$  (in absence of national safety factors). The number n shall be rounded upwards to an integer number.
- d) DIBt letter November 13<sup>th</sup>, 2017 lays out that ETICS anchor approvals do cover wind resistances only. Effects caused by ETICS' weight and hygrothermal influences are not considered. In every case the ETICS approval must be considered.
- e)  $w_e$ =characteristic external wind suction according EN 1991-1-4:2005-04 and national annexes
- f) The application of the indicated anchor pattern pre-assumes that the anchors are set with a distance  $\geq 150$ mm to the edge of the panels

**Number of anchors based on wind loads  $w_e$  for FKD-MAX panels, size 1200mm x 400mm and base material categories A, B, C, D, E <sup>a) b) c) d)</sup>**

wind load $w_e$ [kN/m <sup>2</sup> ] <sup>e)</sup>	Number of anchors per m <sup>2</sup>	Anchor pattern <sup>f)</sup>
FKD-MAX		
Panel size: 1200mm x 400mm		
$\leq 0,50$	6	
$\leq 0,60$	7	
$\leq 0,70$	8	
$\leq 0,80$	9	
$\leq 0,90$	10	
$\leq 1,0$	11	
$\leq 1,12$	12	

- a) The design of anchorages must be carried out in accordance to ETAG 014 and ETAG 004 under the responsibility of an engineer experienced in anchorages.
- b) The table considers a safety factor for the base material of  $\gamma_{M,BM}=2,0$ , for EPS  $\gamma_{M,EPS}=1,5$ , for mineral wool  $\gamma_{M,MW}=2,0$  and for wind action  $\gamma_F=1,5$
- c) All base materials given in tables before are covered. In case that the characteristic resistance is determined by job site tests, the number of anchors is determined by the greater number in the table and  $n = w_e / (N_{rk,job\ site} / (\gamma_{M,BM} \times \gamma_F))$ , where  $N_{rk,job\ site}$ =characteristic resistance determined by job site tests,  $\gamma_{M,BM}=2,0$  and  $\gamma_F=1,50$  (in absence of national safety factors). The number n shall be rounded upwards to an integer number.
- d) DIBt letter November 13<sup>th</sup>, 2017 lays out that ETICS anchor approvals do cover wind resistances only. Effects caused by ETICS' weight and hygrothermal influences are not considered. In every case the ETICS approval must be considered.
- e)  $w_e$ =characteristic external wind suction according EN 1991-1-4:2005-04 and national annexes
- f) The application of the indicated anchor pattern pre-assumes that the anchors are set with a distance  $\geq 150$ mm to the edge of the panels

**Point Thermal Transmittance**

Anchor size		HTH 8x125	HTH 8x155
Point thermal transmittance $\chi$	[W/K]	0,001 ( $t_{fix}= 80$ mm, $100$ mm $\leq h_D \leq 150$ mm)	0,000 ( $t_{fix}= 80$ mm, $150$ mm $< h_D \leq 360$ mm)

**Plate stiffness and plate capacity <sup>a) b)</sup>**

Anchor size		HTH 8x125	HTH 8x155
Capacity of plate	[kN]	1,80	
Plate stiffness	[kN/mm]	0,70	

- a) Test report DET 15-008, HILTI corporation, Schaan (LI), 13.04.2015, testing in accordance with EOTA-TR026, 06.2007
- b) The data are related to the performance of the helix-shaped insulation holder of HTH. The naming plate stiffness and plate capacity were kept because that is the common nomenclature.



## Materials

### Material quality

Part	Material
Anchor sleeve	Polypropylene, black
Expansion screw	Steel, galvanized
Plug	EPS
PU-Foam	Polyurethane, thermal conductivity $\leq 0,045$ W/(mK)

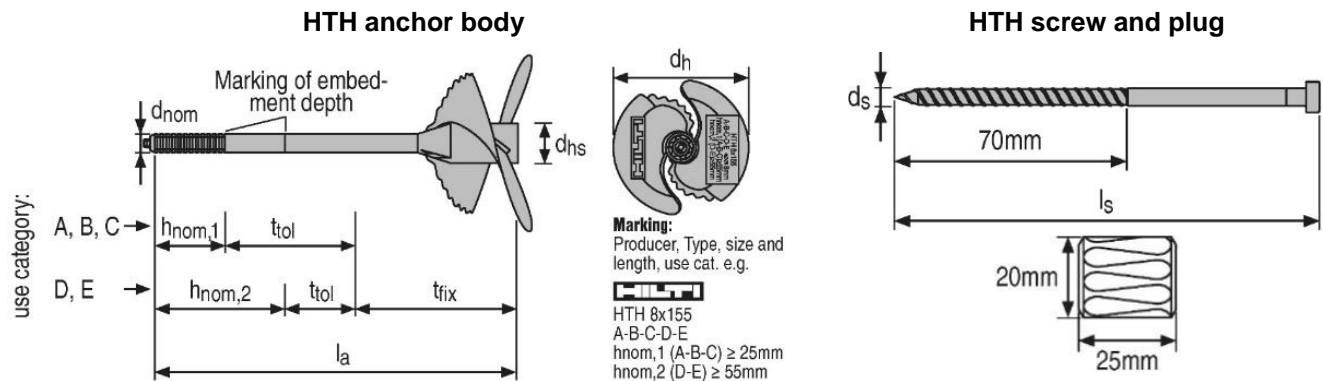

### Anchor size

		HTH 8x125	HTH 8x155
Diameter of sleeve	$d_{nom}$ [mm]	8	
Length of sleeve	$l_a$ [mm]	125	125
Diameter of helix center	$d_{hs}$ [mm]	17	
Diameter of helix	$d_h$ [mm]	75	
Screw diameter	$d_s$ [mm]	5,35	
Length of screw	$l_s$ [mm]	94	94

### Anchor designations

		HTH
Anchor sleeve	Top of helix	Producer: HILTI Anchor type: HTH Size and length [mm]: e.g. 8x155 Use categories (base materials): A-B-C-D-E Overall embedment depth in use categories A, B and C: $h_{nom,1}$ (A-B-C) $\geq 25$ mm Overall embedment depth in use categories D and E: $h_{nom,2}$ (D-E) $\geq 55$ mm
	Sleeve	Embedment depth $h_{nom,1}$ =end of corrugated part of sleeve (25mm) Embedment depth $h_{nom,2}$ =circumferential line at sleeve (55mm)

**Setting information****Installation temperature range:**

0°C to +40°C

**Service temperature range**

Hilti HTH insulation fastener may be applied in the temperature ranges given below.

**Service temperature range**

Temperature range	Base material temperature	Maximum long term base material temperature	Maximum short term base material temperature
Temperature range	0 °C to +40 °C	+24 °C	+40 °C

**Maximum short term base material temperature**

Short-term elevated base material temperatures are those that occur over brief intervals, e.g. as a result of diurnal cycling.

**Maximum long term base material temperature**

Long-term elevated base material temperatures are roughly constant over significant periods of time.

**The anchor shall not be exposed to UV-radiation for more than 6 weeks**

**Setting details for concrete and solid masonry (use category A, B)**

		HTH 8x125	HTH 8x155
Nominal diameter of drill bit	$d_o$ [mm]	8	
Cutting diameter of drill bit	$d_{cut}$ [mm]	8,45	
Minimum depth of drilled hole to the deepest point	$h_1$ [mm]	45	
Overall plastic anchor embedment depth in the base material	$h_{nom,1}$ [mm]	25	
Thickness of fixture	$t_{fix}$ [mm]	80	80
Thickness of equalizing layer for compensation of tolerances or non-loadbearing layer	$t_{tol,min}$ [mm]	0	0
	$t_{tol,max}$ [mm]	20	20
Total length of borehole	$h_3$ [mm]	$h_D+65$	$h_D+95$

**Setting details for thin concrete members (e.g. weather resistant skins or external wall panels) and hollow masonry (use category C)**

		HTH 8x125	HTH 8x155
Nominal diameter of drill bit	$d_o$ [mm]	8	
Cutting diameter of drill bit	$d_{cut}$ [mm]	8,45	
Minimum depth of drilled hole to the deepest point	$h_1$ [mm]	45	
Overall plastic anchor embedment depth in the base material	$h_{nom,1}$ [mm]	25	
Thickness of fixture	$t_{fix}$ [mm]	80	80
Thickness of equalizing layer for compensation of tolerances or non-loadbearing layer	$t_{tol,min}$ [mm]	0	0
	$t_{tol,max}$ [mm]	20	20
Total length of borehole	$h_3$ [mm]	$h_D+65$	$h_D+95$

a)  $t_{tol,min}$  may be lower if the anchor performance is tested on site.

**Setting details for lightweight aggregate concrete and autoclaved aerated concrete (use category D, E)**

		HTH 8x125	HTH 8x155
Nominal diameter of drill bit	$d_o$ [mm]	-	8
Cutting diameter of drill bit	$d_{cut}$ [mm]	-	8,45
Minimum depth of drilled hole to the deepest point	$h_1$ [mm]	-	75
Overall plastic anchor embedment depth in the base material	$h_{nom,1}$ [mm]	-	55
Thickness of fixture	$t_{fix}$ [mm]	-	80
Thickness of equalizing layer for compensation of tolerances or non-loadbearing layer	$t_{tol,min}$ [mm]	-	0
	$t_{tol,max}$ [mm]	-	20
Total length of borehole	$h_3$ [mm]	-	$h_D+95$

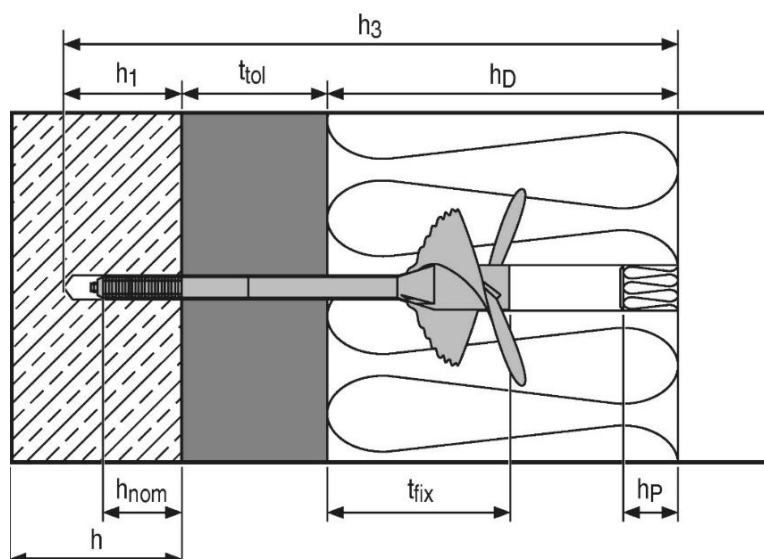

### Setting parameters

			HTH
Minimum base material thickness	Concrete, masonry, lightweight aggregate concrete and autoclaved aerated concrete	$h_{min}$ [mm]	100
	Thin concrete members (e.g. weather resistant skins of external wall panels)		40
Minimum spacing		$s_{min}$ [mm]	100
Minimum edge distance		$c_{min}$ [mm]	100

The diagram shows a 3D perspective of a concrete wall with four anchor points. The minimum spacing between anchors is labeled  $s_{min}$ . The minimum edge distance from the wall edge to the nearest anchor is labeled  $c_{min}$ . The minimum base material thickness is labeled  $h_{min}$ .

### Installation equipment

Anchor	HTH
Rotary hammer	TE 2 – TE 7
Installation	Screw driver SFH 22-A or SF 10W or similar (n=370-600 rpm) Setting tool HTH-SW 1 ( $h_D=100-200\text{mm}$ ), HTH-SW 2 ( $h_D=200-360\text{mm}$ ) Setting tool D8-SW 1 ( $h_D=100-200\text{mm}$ ), D8-SW 2 ( $h_D=200-360\text{mm}$ )

### HTH Setting tools

Setting tool HTH-SW 1 or HTH-SW 2	Setting tool D8-SW 1 or D8-SW 2

### Setting tool HTH-SW 1 and HTH-SW 2

Setting tool			HTH-SW 1	HTH-SW 2
Diameter of disk	$d_T$	[mm]	100	
Length of the tool	$l_T$	[mm]	310	477
Applicable insulation thickness	$h_{D,min}$	[mm]	100	200
	increment	[mm]	10	
	$h_{D,max}$	[mm]	200	360

### Setting tool D8-SW 1 and D8-SW 2

Setting tool			D8-SW 1	D8-SW 2
Diameter of disk	$d_T$	[mm]	100	
Length of the tool	$l_T$	[mm]	310	477
Length of distance sleeves (insulation thickness increment)	$l_H$	[mm]	10	
Applicable insulation thickness	$h_{D,min}$	[mm]	100	200
	$h_{D,max}$	[mm]	200	360

**Setting instruction\*****\*For detailed information on installation see instruction for use given with the package of the product.**

Setting instructions	
<b>1. Drill hole with drill bit</b> 	<b>2. Set insulation thickness</b> 
<b>3. Prepare the setting tool</b> <b>click!</b> 	<b>4. Insert fastener by hand</b> 
<b>5. Insert the helix with setting tool</b> 	
<b>6. Cover the whole with the plug or mortar</b> 	

### 3.7.3 HTR-P (M)

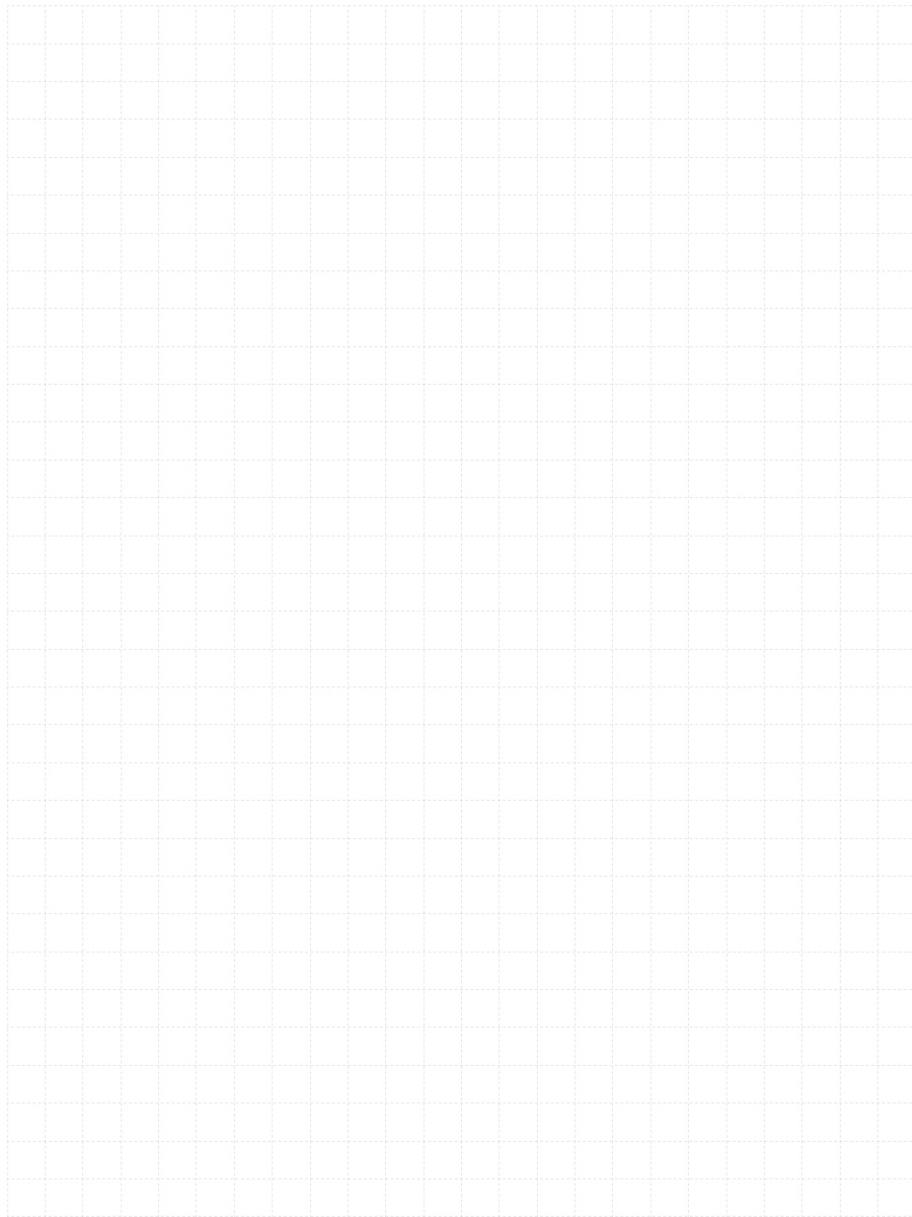
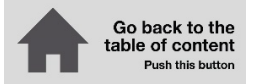

# HTR-P / HTR-M Insulation fastener

## Anchor version



HTR-P  
HTR-M

## Benefits

- Best in class setting comfort and surface finish
- Productivity increase
- Heat transmission class 0 W/K due to screw made of high performance plastic
- Fastening in all base materials of category A, B, C, D and E

## Base material



Concrete

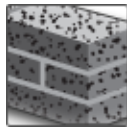

Solid brick

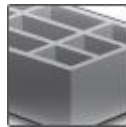

Hollow brick

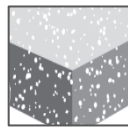

Lightweight  
Aggregate  
concrete

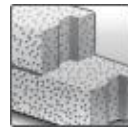

Autoclaved  
Aerated  
concrete

## Other information

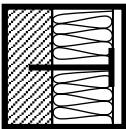

Fastening of  
insulation at the  
wall only



European  
Technical  
Assessment



CE  
conformity

## Approvals/Certificates

Description	Authority / Laboratory	No. / date of issue
European technical assessment <sup>a)</sup>	ZAG, Ljubljana	ETA-16/0116 / 2018-03-28

a) All data given in this section are - if not otherwise indicated - in accordance ETA-16/0116, issue 2018-03-28

### Basic loading data (for a single anchor)

#### All data in this section applies to:

- Correct setting (see setting instruction)
- No edge distance and spacing influence
- Base material as specified in table
- Minimum base material thickness or greater
- Transmission of wind suction loads only
- Redundant fastening in non-cracked concrete
- Anchor and its plate is not exposed to UV-radiation for more than 6 weeks

#### Anchorage depth

Anchor		HTR-P / HTR-M
Overall plastic anchor embedment depth in the base material	$h_{nom} \geq$ [mm]	30

#### Characteristic resistance

Base material		HTR-P / HTR-M
Concrete C12/15	$N_{Rk}$ [kN]	1,00
Concrete 16/20 – C50/60	$N_{Rk}$ [kN]	1,50
Thin concrete members (e.g. weather resistant skins of external wall panels) C16/20 – C50/60	$N_{Rk}$ [kN]	1,20
Solid clay brick, Mz 12/2,0	$N_{Rk}$ [kN]	1,20
Solid sand-lime brick, KS 12/1,8	$N_{Rk}$ [kN]	1,50
Vertically perforated clay brick, Hlz 20/1,6	$N_{Rk}$ [kN]	1,20 <sup>a)</sup>
Vertically perforated clay brick, Hlz 12/0,8	$N_{Rk}$ [kN]	0,70 <sup>b)</sup>
Vertically perforated sand-lime brick, KSL 12/1,4	$N_{Rk}$ [kN]	1,20 <sup>a)</sup>
Lightweight Aggregate Concrete $\geq$ LAC4, (raw density $\geq$ 1,4 kg/dm <sup>3</sup> )	$N_{Rk}$ [kN]	0,90
Autoclaved aerated concrete $\geq$ PP4 (raw density $\geq$ 0,5 kg/dm <sup>3</sup> )	$N_{Rk}$ [kN]	0,50 / 0,75 <sup>c)</sup>

a) The value applies only for outer web thickness  $\geq$  20 mm, rotary drilling only

b) The value applies only for outer web thickness  $\geq$  11 mm, rotary drilling only

c) The greater resistance is applicable only with alternative (greater) embedment depth  $h_{nom}=50$ mm

#### Design resistance

Base material		HTR-P / HTR-M
Concrete C12/15	$N_{Rd}$ [kN]	0,50
Concrete 16/20 – C50/60	$N_{Rd}$ [kN]	0,75
Thin concrete members (e.g. weather resistant skins of external wall panels) C16/20 – C50/60	$N_{Rd}$ [kN]	0,60
Solid clay brick, Mz 12/2,0	$N_{Rd}$ [kN]	0,60
Solid sand-lime brick, KS 12/1,8	$N_{Rd}$ [kN]	0,75
Vertically perforated clay brick, Hlz 20/1,6	$N_{Rd}$ [kN]	0,60 <sup>a)</sup>
Vertically perforated clay brick, Hlz 12/0,8	$N_{Rd}$ [kN]	0,35 <sup>b)</sup>
Vertically perforated sand-lime brick, KSL 12/1,4	$N_{Rd}$ [kN]	0,60 <sup>a)</sup>
Lightweight Aggregate Concrete $\geq$ LAC4, (raw density $\geq$ 1,4 kg/dm <sup>3</sup> )	$N_{Rd}$ [kN]	0,45
Autoclaved aerated concrete $\geq$ PP4 (raw density $\geq$ 0,5 kg/dm <sup>3</sup> )	$N_{Rd}$ [kN]	0,25 / 0,375 <sup>c)</sup>

a) The value applies only for outer web thickness  $\geq$  20 mm, rotary drilling only

b) The value applies only for outer web thickness  $\geq$  11 mm, rotary drilling only

c) The greater resistance is applicable only with alternative (greater) embedment depth  $h_{nom}=50$ mm



**Recommended loads**

Base material		HTR-P / HTR-M
Concrete C12/15	N <sub>Rec</sub> [kN]	0,33
Concrete 16/20 – C50/60	N <sub>Rec</sub> [kN]	0,50
Thin concrete members (e.g. weather resistant skins of external wall panels) C16/20 – C50/60	N <sub>Rec</sub> [kN]	0,40
Solid clay brick, Mz 12/2,0	N <sub>Rec</sub> [kN]	0,40
Solid sand-lime brick, KS 12/1,8	N <sub>Rec</sub> [kN]	0,50
Vertically perforated clay brick, Hlz 20/1,6	N <sub>Rec</sub> [kN]	0,40 <sup>a)</sup>
Vertically perforated clay brick, Hlz 12/0,8	N <sub>Rec</sub> [kN]	0,23 <sup>b)</sup>
Vertically perforated sand-lime brick, KSL 12/1,4	N <sub>Rec</sub> [kN]	0,40 <sup>a)</sup>
Lightweight Aggregate Concrete ≥ LAC4, (raw density ≥ 1,4 kg/dm <sup>3</sup> )	N <sub>Rec</sub> [kN]	0,30
Autoclaved aerated concrete ≥ PP4 (raw density ≥ 0,5 kg/dm <sup>3</sup> )	N <sub>Rec</sub> [kN]	0,167 / 0,25 <sup>c)</sup>

a) The value applies only for outer web thickness ≥ 20 mm, rotary drilling only

b) The value applies only for outer web thickness ≥ 11 mm, rotary drilling only

c) The greater resistance is applicable only with alternative (greater) embedment depth h<sub>nom</sub>=50mm

**Recommended pull-through (short term acting) loads in different insulation materials<sup>a)</sup>**

Insulation	Thickness [mm]	Plate-Ø [mm]	Pull-through load [kN]
Expanded polystyrene EPS	60 - 119	≥ 60	0,15
Expanded polystyrene EPS	120 - 260	≥ 60	0,20
Mineral wool, type HD	60 - 260	≥ 60	0,15
Mineral wool, type WV	60 - 260	≥ 90	0,15 <sup>b)</sup>
Mineralwolle, type lamella	60 - 260	≥ 140	0,167 <sup>c)</sup>

a) This technical data are not covered by ETA-16/0116. They are based on an HILTI-internal assessment of test data. Recommended values can be used in case that the insulation material to be fastened is not covered by a European Technical Assessment (ETA) or any national approval document. If the ETICS to be fastened is covered by an ETA or any national approval document, the given pull-through resistance in the ETA or national approval document is applicable. The design of anchorages has to be carried out in accordance to EAD 330196-01-0604 and ETAG 004 or EAD 040083-00-0404 or applicable national regulation under the responsibility of an engineer experienced in anchorages.

b) HILTI slip-on plate HDT 90 must be used

c) HILTI slip-on plate HDT 140 must be used

### Basic provisions for dead loads on the bottom side of ceilings (for a single anchor)

#### All data in this section applies to

- Correct setting (see setting instruction)
- No edge distance and spacing influence
- Base material as specified in the table
- Minimum base material thickness
- Quasi-static permanent loads only
- Redundant fastening in non-cracked and cracked concrete
- Anchor and its plate is not exposed to UV-radiation for more than 6 weeks

**Note:** Pull-through resistance of panel and its bending resistance shall be proven by panel manufacturer or any other person experienced in the design of such panels. Drawings of fixing positions shall be provided to the operator. Each panel shall be fixed with 4 anchors at least.

#### Recommended number of anchors for fixing panels to ceilings w/o consideration of wind loads<sup>a)</sup>:

Specific panels weight	Number of anchors per m <sup>2</sup>
≤ 29 kg/m <sup>2</sup>	4
≤ 43 kg/m <sup>2</sup>	6
≤ 57 kg/m <sup>2</sup>	8
≤ 71 kg/m <sup>2</sup>	10

a) This technical data are not covered by ETA-16/0116. They are based on an HILTI-internal assessment of test data. A safety factor for dead load  $\gamma_F=1,35$  and a safety factor  $\gamma_M=1,80$  for material is considered.

### Additional technical parameters

#### Point thermal transmittance

Anchor	HTR-P / HTR-M
Point thermal transmittance <sup>a)</sup> $\chi$ [W/K]	0,000

a) For insulation thickness 60-260 mm

#### Plate stiffness and plate capacity

Anchor	HTR-P / HTR-M
Capacity of plate [kN]	1,4
Plate stiffness [kN/mm]	0,6

**Materials**
**Material quality**

Part		Material
Anchor sleeve		Polyethylene, black
Anchor plate		Polypropylene, red
Expansion plastic screw	HTR-P	Polyamide, glass fiber reinforced 50%, black
Composite screw	HTR-M	Expansion element: steel, galvanized Shank: polyamide, glass fiber reinforced, black
Slip-on plate	HDT 90	Polypropylene, glass fiber reinforced, white
Slip-on plate	HDT 140	Polyamide, glass fiber reinforced, white

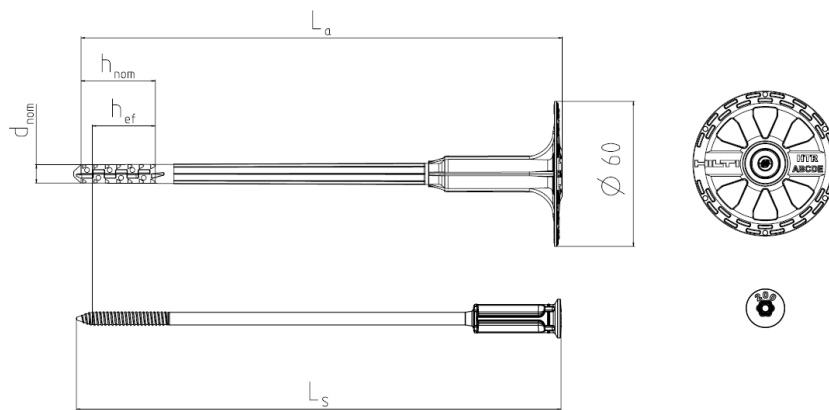
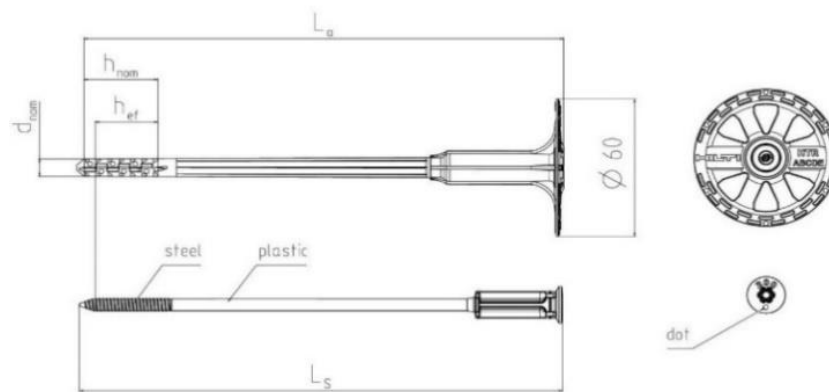
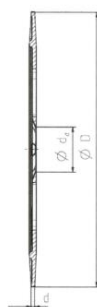
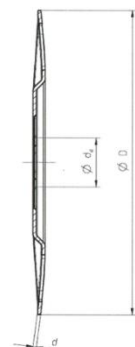
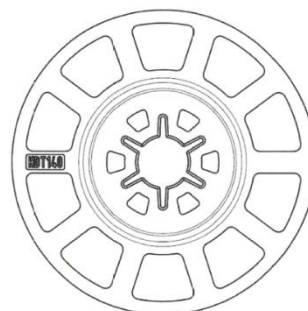
**HTR-P**

**HTR-M**

**HDT 90**

**HDT 140**

**Anchor dimensions**

		HTR-P / HTR-M
Diameter of sleeve	$d_{nom}$ [mm]	8
Plate diameter	$d$ [mm]	60
Minimum length of anchor body	$L_{a,min}$ [mm]	100
Maximum length of anchor body	$L_{a,max}$ [mm]	300
Minimum length of screw	$L_{S,min}$ [mm]	101
Maximum length of screw	$L_{S,max}$ [mm]	301

**Slip-on plate dimensions**

		HDT 90	HDT 140
External diameter	$D$ [mm]	90	140
Internal diameter	$d_d$ [mm]	23	
Thickness	$d$ [mm]	1,5	

**Anchor designations**

		HTR-P / HTR-M
Expansion screw	Top of head	HTR-P: Anchor length $L_a$ (e.g. "300") HTR-M: Anchor length $L_a$ (e.g. "300" and a dot •)
Plate	Top of plate	Producer: HILTI
		Anchor type: HTR
	Bottom side of plate	Nominal embedment depth: $h_{nom}=30$ mm for base material categories A, B, C, D, E Nominal drill bit diameter: 8 mm

**Setting information****Installation temperature range:**

0°C to +40°C

**Service temperature range**

Hilti HTR-P, HTR-M insulation fastener may be applied in the temperature ranges given below.

**Service temperature range**

Temperature range	Base material temperature	Maximum long term base material temperature	Maximum short term base material temperature
Temperature range I	0 °C to +40 °C	+24 °C	+40 °C

**Maximum short-term base material temperature**

Short-term elevated base material temperatures are those that occur over brief intervals, e.g. because of diurnal cycling.

**Maximum long-term base material temperature**

Long-term elevated base material temperatures are roughly constant over significant periods of time.

**The anchor shall not be exposed to UV-radiation for more than 6 weeks**

**Setting details**

			HTR-P / HTR-M
			Base material category A, B, C, D and E <sup>a)</sup>
Nominal diameter of drill bit	$d_o$	[mm]	8
Cutting diameter of drill bit	$d_{cut} \leq$	[mm]	8,45
Depth of drill hole	$h_1 \geq$	[mm]	40
Effective anchorage depth	$h_{ef} \geq$	[mm]	25
Overall embedment depth	$h_{nom}$	[mm]	30
Thickness of insulation	$h_D$	[mm]	60 to 260
Maximum thickness of tolerance layer	$t_{tol,max}$	[mm]	$L_a - h_{nom} - h_D^{b)}$

a) In base material category E (autoclaved aerated concrete PP4) an alternative embedment depth  $h_{nom} = 50\text{mm}$  with greater resistance is available with corresponding drill hole depth  $h_1 \geq 60\text{mm}$

b)  $L_a$  ... Anchor length,  $h_{nom}$  ... Overall embedment depth,  $h_D$  ... Thickness of insulation

Example:

HTR-P 8x300 or HTR-M 8x300:  $L_a = 300\text{mm}$ ;  $h_{nom} = 30\text{mm}$ ;  $h_D = 260\text{mm}$

$t_{tol,max} = 300\text{mm} - 30\text{mm} - 260\text{mm} = 10\text{mm}$

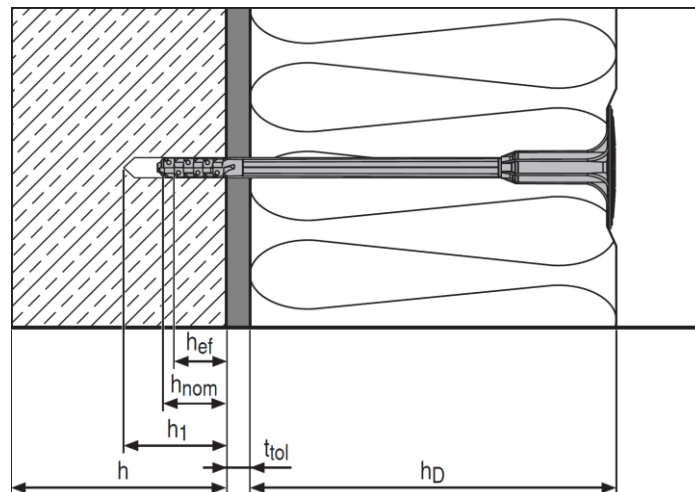
**Setting parameters**

			HTR-P / HTR-M
Minimum base material thickness	$h_{min}$	[mm]	100 <sup>a)</sup>
Minimum spacing	$s_{min}$	[mm]	100
Minimum edge distance	$c_{min}$	[mm]	100

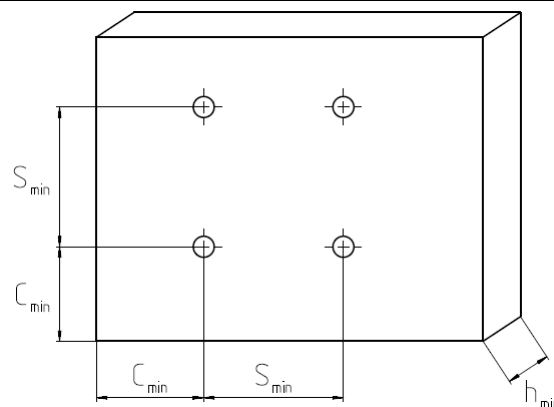

a) Except for thin concrete members (e.g. weather resistant skins of external walls) with  $h_{min}=40\text{mm}$ ). The belonging characteristic resistance must be considered.

**Installation equipment**

<b>HTR-P / HTR-M</b>	
Rotary hammer	Corded: HILTI TE 2 – TE 7 Battery: HILTI TE2-A22, TE4-A22, TE6-A36
Installation	Electrical screw driver e.g. HILTI SF 2-A + TX30 The use of setting tool SW-HTR is recommended

**Setting instruction\***

\*For detailed information on installation see instruction for use given with the package of the product.

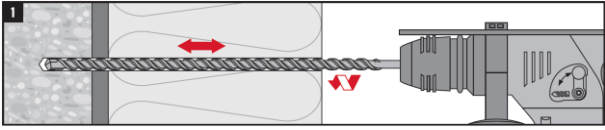
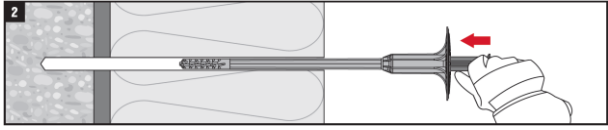
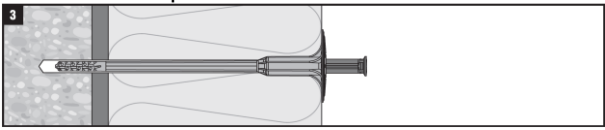
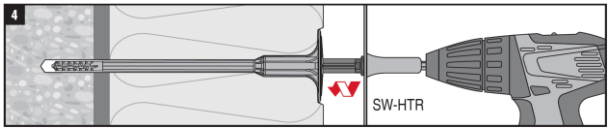
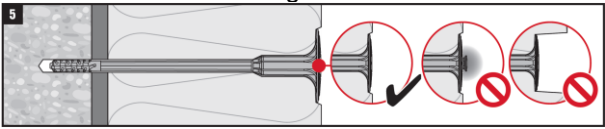
<b>Setting instructions</b>	
<p>1. Drill hole with drill bit</p> 	<p>2. Insert the fastener by hand</p> 
<p>3. Make sure that anchor's plate is in touch with insulation panel's surface</p> 	<p>4. Use screw driver with setting tool to insert the fastener</p> 
<p>5. Check correct setting</p> 	

### 3.7.4 HTS-P (M)

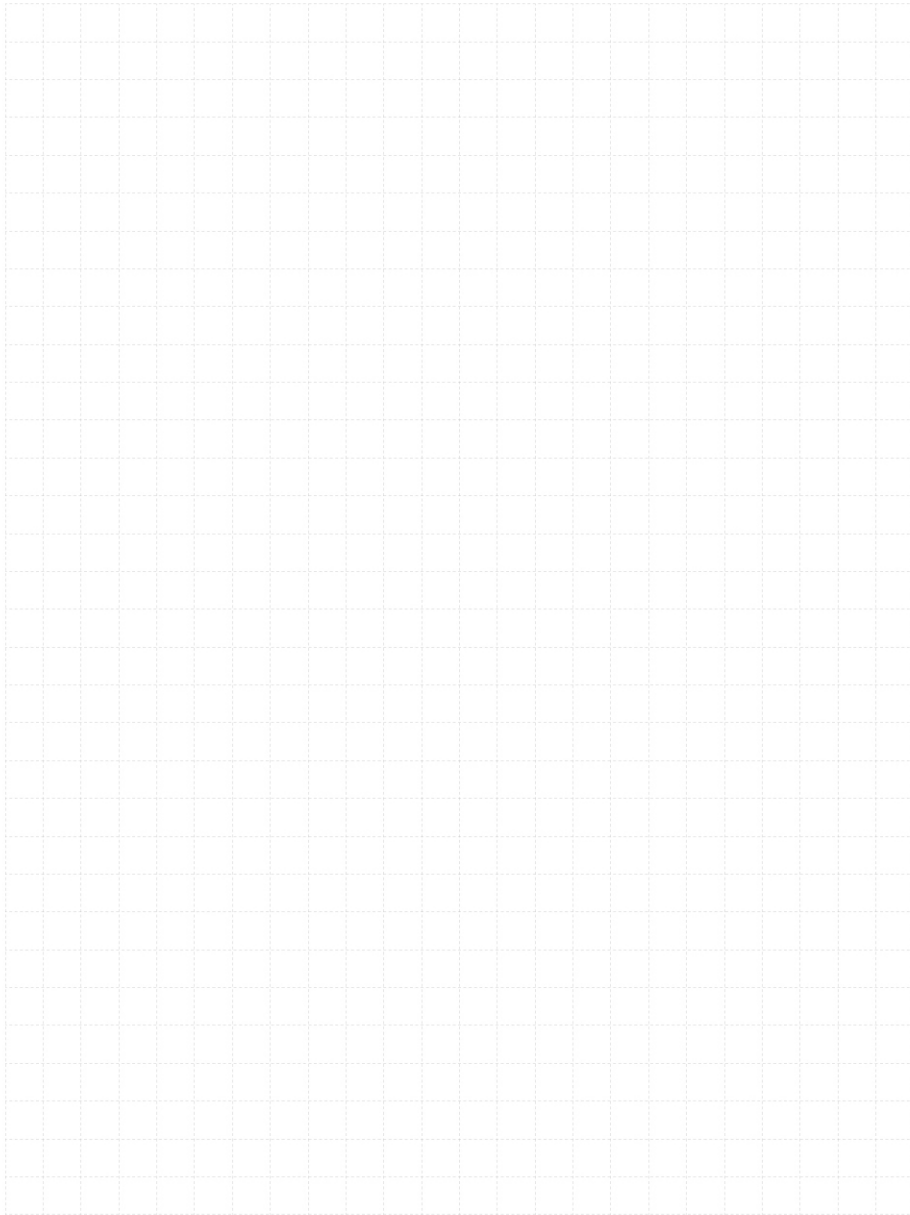



# T-Save HTS-P / HTS-M Insulation fastener

## Anchor version



T-Save HTS-P  
T-Save HTS-M

## Benefits

- Fastening in all base materials of category A, B, C, D and E
- Easy and fast to install
- Best insulation surface finish
- Heat transmission class 0,000 W/K

## Base material

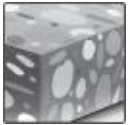

Concrete  
(non-cracked)

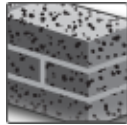

Solid brick

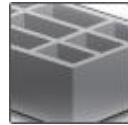

Hollow brick

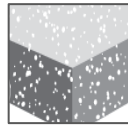

Lightweight  
Aggregate  
concrete

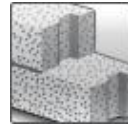

Autoclaved  
aerated  
concrete

## Other information

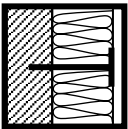

Fastening of  
insulation



European  
Technical  
Assessment



CE  
conformity

## Approvals/Certificates

Description	Authority / Laboratory	No. / date of issue
European technical assessment <sup>a)</sup>	ZAG, Ljubljana	ETA-14/0400 / 2017-06-23

### Basic loading data (for a single anchor)

#### All data in this section applies to:

- Correct setting (see setting instruction)
- No edge distance and spacing influence
- Redundant fastenings in the base materials as specified in the tables
- Minimum base material thickness or greater
- Transmission of wind suction loads only
- Anchor and its plate is not exposed to UV-radiation for more than 6 weeks

#### Anchorage depth

Base material			T-Save HTS-P / T-Save HTS-M
Overall plastic anchor embedment depth in the base material	$h_{nom} \geq$	[mm]	30

#### Characteristic resistance (short term acting load)

Base material			T-Save HTS-P / T-Save HTS-M
Concrete $\geq$ C12/15	$N_{Rk}$	[kN]	0,9
Solid clay brick Mz 12/2,0	$N_{Rk}$	[kN]	0,9
Solid sand-lime brick KS 12/1,8	$N_{Rk}$	[kN]	0,9
Vertically perforated clay brick Hlz 20/1,6	$N_{Rk}$	[kN]	0,75 <sup>a)</sup>
Vertically perforated sand-lime brick KSL 12/1,4	$N_{Rk}$	[kN]	0,75 <sup>a)</sup>
Lightweight Aggregate Concrete $\geq$ LAC4 (raw density $\geq$ 1,4 kg/dm <sup>3</sup> )	$N_{Rk}$	[kN]	0,60
Autoclaved aerated concrete $\geq$ PP4 (raw density $\geq$ 0,5 kg/dm <sup>3</sup> )	$N_{Rk}$	[kN]	0,40

a) The value applies only for outer web thickness  $\geq$  20 mm, rotary drilling only

#### Design resistance (short term acting load)

Base material			T-Save HTS-P / T-Save HTS-M
Concrete $\geq$ C12/15	$N_{Rd}$	[kN]	0,45
Solid clay brick Mz 12/2,0	$N_{Rd}$	[kN]	0,45
Solid sand-lime brick KS 12/1,8	$N_{Rd}$	[kN]	0,45
Vertically perforated clay brick Hlz 20/1,6	$N_{Rd}$	[kN]	0,375 <sup>a)</sup>
Vertically perforated sand-lime brick KSL 12/1,4	$N_{Rd}$	[kN]	0,375 <sup>a)</sup>
Lightweight Aggregate Concrete $\geq$ LAC4 (raw density $\geq$ 1,4 kg/dm <sup>3</sup> )	$N_{Rd}$	[kN]	0,30
Autoclaved aerated concrete $\geq$ PP4 (raw density $\geq$ 0,5 kg/dm <sup>3</sup> )	$N_{Rd}$	[kN]	0,20

a) The value applies only for outer web thickness  $\geq$  20 mm, rotary drilling only

**Recommended loads (short term acting load)**

Base material			T-Save HTS-P / T-Save HTS-M
Concrete $\geq$ C12/15	$N_{Rec}$	[kN]	0,3
Solid clay brick Mz 12/2,0	$N_{Rec}$	[kN]	0,3
Solid sand-lime brick KS 12/1,8	$N_{Rec}$	[kN]	0,3
Vertically perforated clay brick Hlz 20/1,6	$N_{Rec}$	[kN]	0,25 <sup>a)</sup>
Vertically perforated sand-lime brick KSL 12/1,4	$N_{Rec}$	[kN]	0,25 <sup>a)</sup>
Lightweight Aggregate Concrete $\geq$ LAC4 (raw density $\geq$ 1,4 kg/dm <sup>3</sup> )	$N_{Rec}$	[kN]	0,20
Autoclaved aerated concrete $\geq$ PP4 (raw density $\geq$ 0,5 kg/dm <sup>3</sup> )	$N_{Rec}$	[kN]	0,13

a) The value applies only for outer web thickness  $\geq$  20 mm, rotary drilling only

**Recommended (short term) pull-through loads in different insulation materials <sup>a)</sup>**

Base material	Thickness [mm]	Plate- $\varnothing$ [mm]	Pull-through load [kN]
Expanded polystyrene EPS	60-100	$\geq$ 60	0,15
Expanded polystyrene EPS	120-260	$\geq$ 60	0,20
Mineral wool, type HD	60-260	$\geq$ 60	0,15
Mineral wool, type WV	60-260	$\geq$ 90	0,15 <sup>b)</sup>
Mineral wool, type lamella	60-260	$\geq$ 140	0,167 <sup>c)</sup>

a) Recommended values in case that the insulation material to be fixed is not covered by a European Technical Assessment (ETA) or any national approval document. If the ETICS to be fixed is covered by an ETA or any national approval document, the given pull-through resistance in the ETA or national approval document is applicable. The design of anchorages must be carried out in accordance to EAD330196-01-0604 and ETAG 004 or applicable national regulation under the responsibility of an engineer experienced in anchorages.

b) HILTI slip-on plate HDT 90 must be used

c) HILTI slip-on plate HDT 140 must be used

## Basic provisions for fixing insulation on the bottom side of ceilings

### All data in this section applies to

- Correct setting (see setting instruction)
- No edge distance and spacing influence
- Redundant fastening in non-cracked concrete
- Minimum base material thickness or greater
- Transmission of quasi-static permanent loads only
- Anchor and its plate is not exposed to UV-radiation for more than 6 weeks

**Note:** Each panel shall be supported by 4 anchors at least e.g. by T-joint fixing.

### Recommended number of anchors for fixing panels to ceilings w/o consideration of wind load<sup>a)</sup>:

Specific panels weight	Number of anchors per m <sup>2</sup>
EPS ( $\leq 30 \text{ kg/m}^3$ , $\text{TR} \geq 100 \text{ kPa}$ , $60 \text{ mm} \leq \text{thickness} \leq 260$ )	4
Mineral wool ( $\leq 120 \text{ kg/m}^3$ , $\text{TR} \geq 3.5 \text{ kPa}$ , $60 \text{ mm} \leq \text{thickness} \leq 120 \text{ mm}$ )	
Mineral wool ( $\leq 150 \text{ kg/m}^3$ , $\text{TR} \geq 3.5 \text{ kPa}$ , $60 \text{ mm} \leq \text{thickness} \leq 100 \text{ mm}$ )	
Mineral wool ( $\leq 200 \text{ kg/m}^3$ , $\text{TR} \geq 3.5 \text{ kPa}$ , $60 \text{ mm} \leq \text{thickness} \leq 70 \text{ mm}$ )	5

a) These technical data are not covered by ETA-14/0400. They are based on a HILTI-internal assessment. A safety factor for dead load  $\gamma_F=1,35$ , a safety factor  $\gamma_{M, \text{EPS}}=1,50$ , a safety factor  $\gamma_{M, \text{Mineralwool}}=2,00$  for material is considered.

## Additional technical parameters

### Point thermal transmittance

Anchor	HTR-P / HTR-M
Point thermal transmittance <sup>a)</sup> $\chi$ [W/K]	0,000

a) For insulation thickness 60-260 mm

### Plate stiffness and plate capacity

Anchor	HTR-P / HTR-M
Capacity of plate [kN]	1,4
Plate stiffness [kN/mm]	0,6

**Materials**
**Material quality**

Part		Material
Anchor sleeve	HTS-P and HTS-M	Polyethylene, black
Anchor plate	HTS-P and HTS-M	Polypropylene, white
Expansion pin	HTS-P	Polyamide, fiber reinforced 50%, black
Expansion pin	HTS-M	Expansion element: steel Shaft: polyamide, fiber reinforced 50%, black
Slip-on plate	HDT 90	Polypropylene, fiber reinforced, white
Slip-on plate	HDT 140	Polyamide, fiber reinforced, white

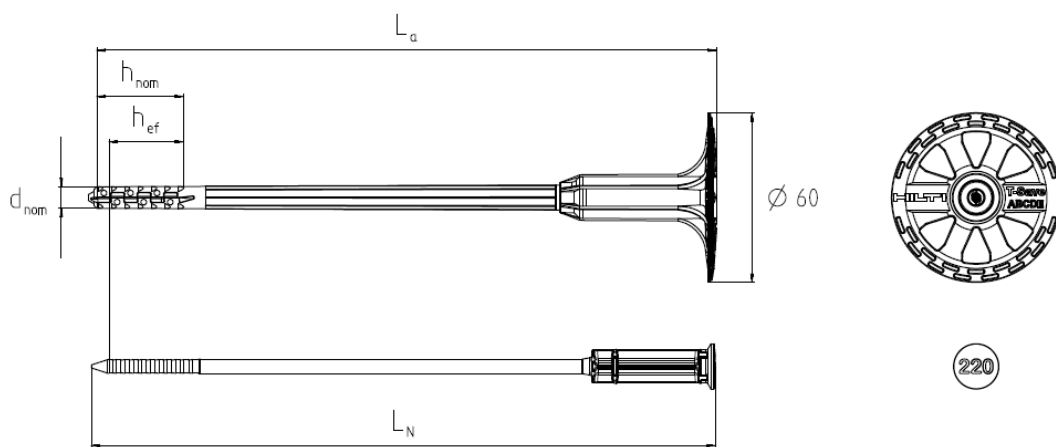
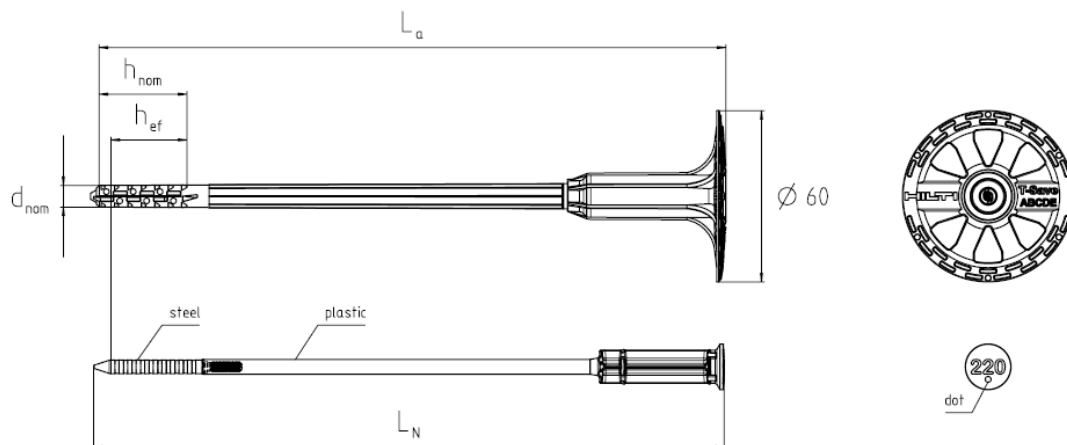
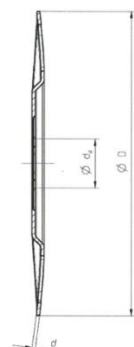
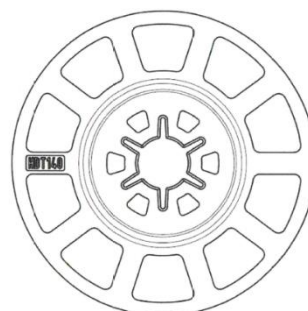
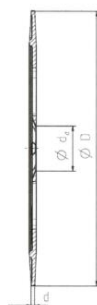
**T-Save HTS-P**

**T-Save HTS-M**

**HDT 90**
**HDT 140**

**Anchor dimensions**

			T-Save HTS-P / T-Save HTS-M
Diameter of sleeve	$d_{nom}$	[mm]	8
Minimum length of anchor body	$L_{a,min}$	[mm]	100
Maximum length of anchor body	$L_{a,max}$	[mm]	300
Minimum length of pin	$L_{N,min}$	[mm]	101
Maximum length of pin	$L_{N,max}$	[mm]	301

**Slip-on plate dimensions**

			HDT 90	HDT 140
External diameter	D	[mm]	90	140
Internal diameter	$d_d$	[mm]	23	
Thickness	d	[mm]	1,5	

**Anchor designations**

		T-Save HTS-P / T-Save HTS-M
Expansion screw	Top of head	T-Save HTS-P: Anchor length $L_a$ (e.g. "220") T-Save HTS-M: Anchor length $L_a$ (e.g. "220" and a dot •)
Plate	Top of plate	Producer: HILTI
		Anchor type: T-Save
	Bottom side of plate	Nominal embedment depth: $h_{nom}=30$ mm for base material categories A, B, C, D, E Nominal drill bit diameter: 8 mm

## Setting information

### Installation temperature range:

0°C to +40°C

### Service temperature range

Hilti HTS-P, HTS-M insulation fastener may be applied in the temperature ranges given below.

#### Service temperature range

	Base material temperature	Maximum long term base material temperature	Maximum short term base material temperature
Temperature range	0 °C to +40 °C	+24 °C	+40 °C

### Maximum short term base material temperature

Short-term elevated base material temperatures are those that occur over brief intervals, e.g. because of diurnal cycling.

### Maximum long term base material temperature

Long-term elevated base material temperatures are roughly constant over significant periods of time.

**The anchor shall not be exposed to UV-radiation for more than 6 weeks**

**Setting details:**

		<b>T-Save HTS-P / T-Save HTS-M</b>
Nominal diameter of drill bit	$d_o$ [mm]	8
Cutting diameter of drill bit	$d_{cut} \leq$ [mm]	8,45
Depth of drill hole	$h_1 \geq$ [mm]	40
Effective anchorage depth	$h_{ef}$ [mm]	25
Overall embedment depth	$h_{nom}$ [mm]	30
Thickness of insulation	$h_D$ [mm]	60 to 260
Maximum thickness of tolerance layer	$t_{tol,max}$ [mm]	$L_a - h_{nom} - h_D^{a)}$

a)  $L_a$  ... Anchor length,  $h_{nom}$  ... Overall embedment depth,  $h_D$  ... Thickness of insulation

Example:

T-Save HTS 8x220-P:  $L_a = 220\text{mm}$ ;  $h_{nom} = 30\text{mm}$ ;  $h_D = 180\text{mm}$

$t_{tol,max} = 220 - 30 - 180 = 10\text{mm}$

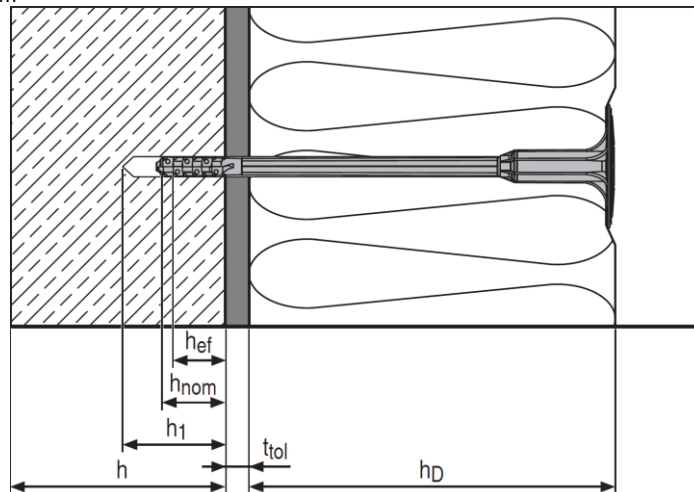
**Installation equipment**

<b>Anchor size</b>	<b>T-Save HTS-P / T-Save HTS-M</b>
Rotary hammer	Corded: HILTI TE 2 – TE 7 Battery: HILTI TE2-A22, TE4-A22, TE6-A36
Installation	Hammer 500g to 1500g

**Minimum edge distance, minimum spacing and minimum base material thickness**

		<b>T-Save HTS-P / T-Save HTS-M</b>
Minimum base material thickness	$h_{min}$ [mm]	100
Minimum spacing	$s_{min}$ [mm]	100
Minimum edge distance	$c_{min}$ [mm]	100

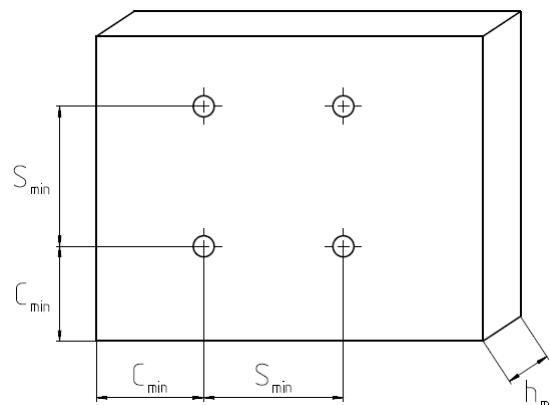



**Installation equipment**

<b>Anchor size</b>	<b>T-Save HTS-P / T-Save HTS-M</b>
Rotary hammer	Corded: HILTI TE 2 – TE 7 Battery: HILTI TE2-A22, TE4-A22, TE6-A36
Installation	Hammer 500g to 1500g

**Setting instruction\***

\*For detailed information on installation see instruction for use given with the package of the product.

<b>Setting instructions</b>	
<b>1. Drill hole with drill bit</b> 	<b>2. Insert the fastener by hand</b> 
<b>3. Tap fastener with a hammer</b> 	<b>4. Check correct setting</b> 

### 3.7.5 IDP

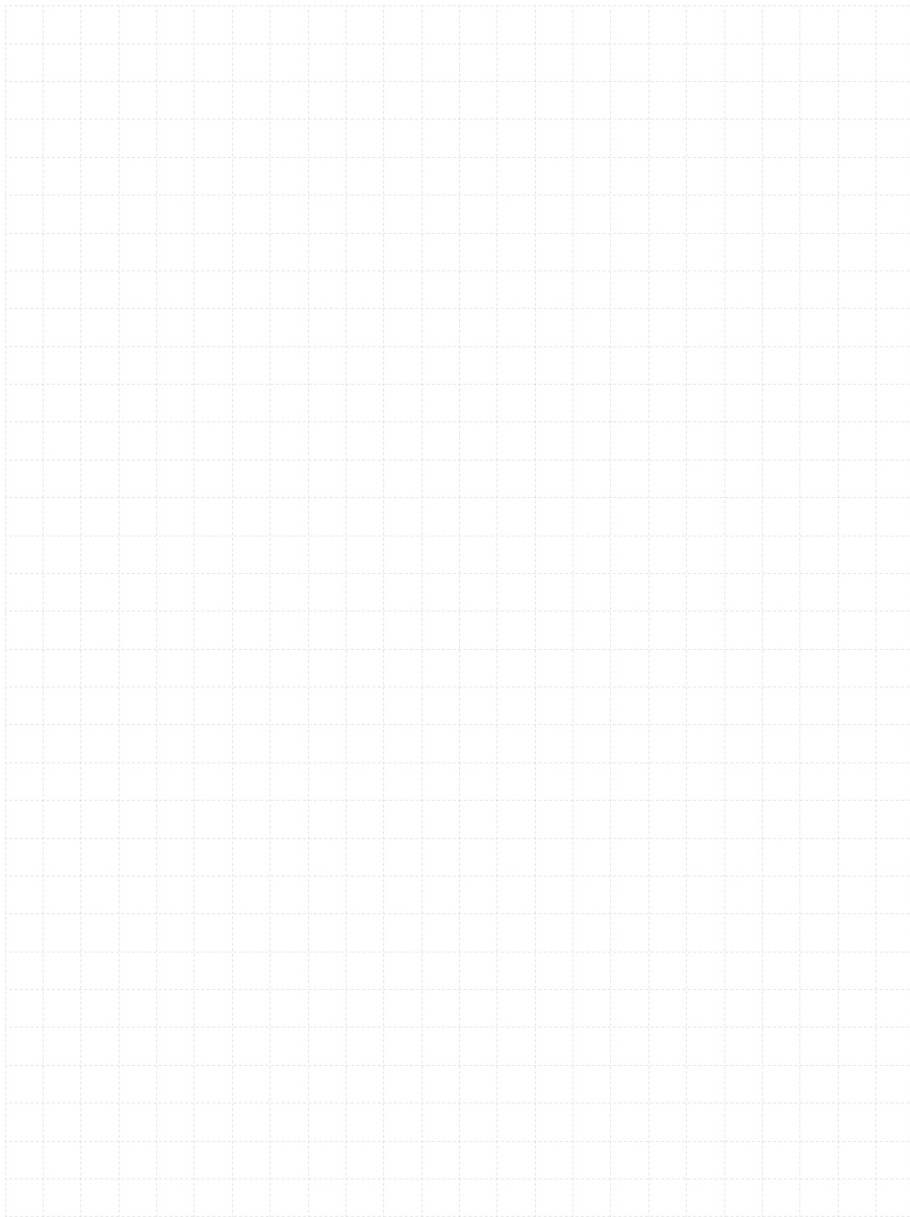

# IDP Insulation fastener

## Anchor version



IDP

## Benefits

- for insulation up to 15 cm
- simple setting

## Base material

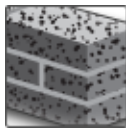
 Concrete  
(non-cracked)

Solid brick

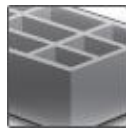

Hollow brick

## Other information

 Fastening of  
insulation at the  
wall only

## Basic loading data (for a single anchor)

### All data in this section applies to:

- Correct setting (see setting instruction)
- No edge distance and spacing influence
- Base material as specified in table
- Minimum base material thickness

### Anchorage depth

Anchor	IDP	
Overall plastic anchor embedment depth in the base material	$h_{nom}$	[mm]
		25

### Recommended loads <sup>a)</sup>

Base material	IDP	
Concrete $\geq$ C16/20	$N_{rec}$	[kN]
		0,14
Solid clay brick Mz 20 – 1,8 – NF	$N_{rec}$	[kN]
		0,14
Solid sand-lime brick KS 12 – 1,6 – 2DF	$N_{rec}$	[kN]
		0,14
Hollow clay brick Hlz 12 – 0,8 – 6DF	$N_{rec}$	[kN]
		0,04 <sup>b)</sup>
Hollow sand-lime brick KSL 12 – 1,4 – 3DF	$N_{rec}$	[kN]
		0,04

a) With overall global safety factor  $\gamma = 5$  to the characteristic loads and a partial safety factor of  $\gamma = 1,4$  to the design values.

b) Drilling without hammering

## Materials

### Material quality

Part	Material
Anchor with plate	Polypropylene

## Setting information

### Installation temperature range:

0°C to +40°C

### Service temperature range

Hilti IDP insulation fastener may be applied in the temperature ranges given below.

### Service temperature range

Temperature range	Base material temperature	Maximum long term base material temperature	Maximum short term base material temperature
Temperature range I	0 °C to +40 °C	+24 °C	+40 °C

### Maximum short-term base material temperature

Short-term elevated base material temperatures are those that occur over brief intervals, e.g. because of diurnal cycling.

### Maximum long-term base material temperature

Long-term elevated base material temperatures are roughly constant over significant periods of time.

**The anchor shall not be exposed to UV-radiation for more than 6 weeks**

## Setting information

### Setting details

Anchor size			0/2	2/4	4/6	6/8	8/10	10/12	13/15
Nominal diameter	$d_0$	[mm]	8						
Cutting diameter of drill bit	$d_{cut} \leq$	[mm]	8,45						
Depth of drill hole	$h_1 \geq$	[mm]	$l - t_{fix} + 10\text{mm} \geq 40\text{mm}$						
Nominal anchorage depth	$h_{nom}$	[mm]	25						
Anchor length	$l$	[mm]	50	70	90	110	130	150	180
Maximum thickness of fixture	$t_{fix}$	[mm]	20	40	60	80	100	120	150

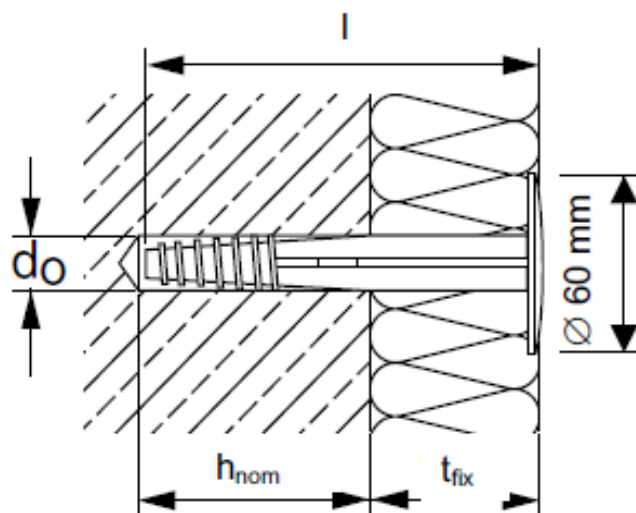

**Installation equipment**

Anchor size	IDP
Rotary hammer	Corded: HILTI TE 2 – TE 7 Battery: HILTI TE2-A22, TE4-A22, TE6-A36
Other tools	Hammer

**Setting instruction\***

\*For detailed information on installation see instruction for use given with the package of the product.

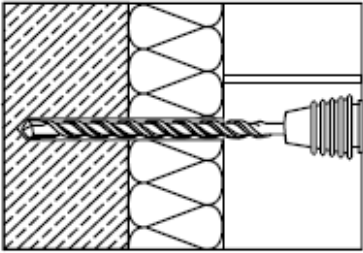
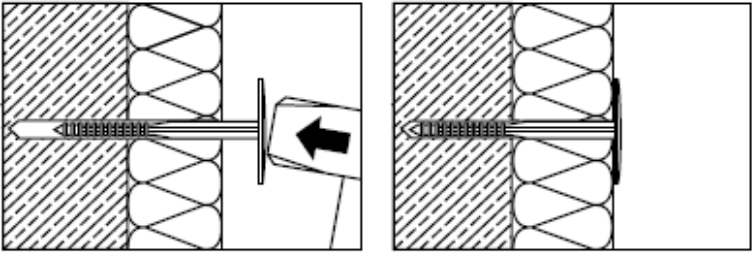
Setting instructions	
<p><b>1. Drill hole with drill bit</b></p> 	<p><b>2. Tap in fastener with a hammer</b></p> 



## 4. ANCHOR CHANNELS

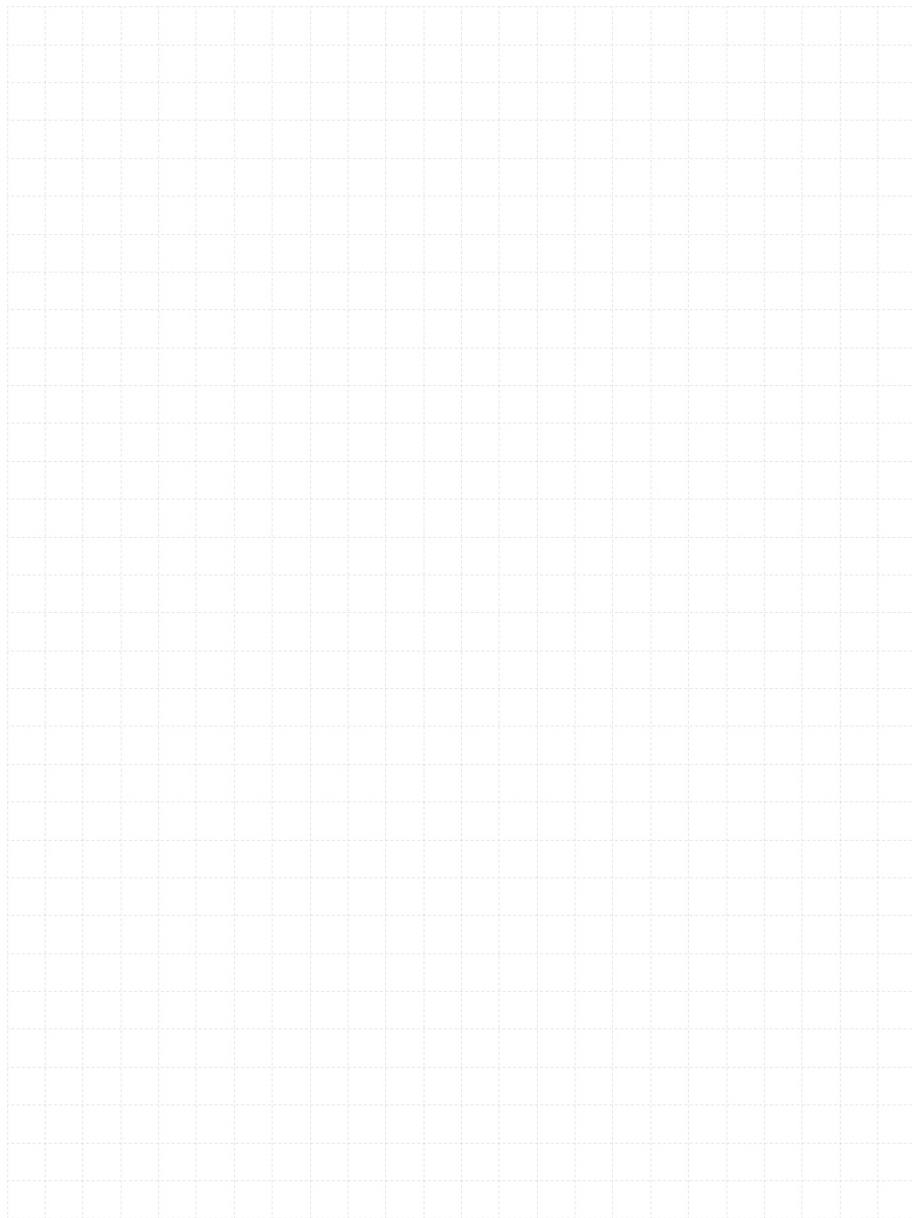

### 4.1.1 HAC-C (cold formed/ hot rolled)





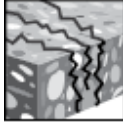
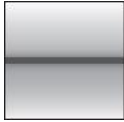

# HAC-C Cold formed

Cast-in anchor channels in standard sizes and lengths for everyday applications

Anchor channel version	Benefits
  HBC-28/15 HBC-38/17 HBC-40/22 HBC-50/30  HAC-C 28/15 HAC-C 38/17 HAC-C 40/25 HAC-C 49/30 HAC-C 54/33	<ul style="list-style-type: none"> <li>- Cold-formed, rounded profiles with constant material thickness – ensuring uniform load capacity;</li> <li>- Versatile solution – engineered for everyday applications;</li> <li>- LDPE foam filler with grab tab – helps to keep concrete out of the channel and can be removed rapidly in one piece;</li> <li>- ETA and fire approval documents available;</li> <li>- Available in stainless steel and hot-dip galvanised versions – helping to provide corrosion protection as needed for specific environmental conditions</li> </ul>

Base material	Load conditions
 Concrete (non-cracked)  Concrete (cracked)	 Static/ quasi-static  Fire resistance  Static 2D loading

Other information			
 European Technical Assessment	 CE conformity	 PROFIS Anchor channel design Software	 Corrosion resistance

## Approvals / certificates

Description	Authority / Laboratory	No. / date of issue
European technical assessment <sup>a)</sup>	DIBt, Berlin	ETA-17/0336 of 09.11.2020

a) All data given in this section according to ETA-17/0336 of 09.11.2020

## Static and quasi-static loading

### All data in this section applies to:

- Correct setting (See setting instruction)
- No edge distance and spacing influence
- No influence of bolt type and diameter
- Decisive failure mode – local flexure of channel lips
- Shear load applied perpendicular to the longitudinal axis of the channel

### Effective anchorage depth

Anchor channel type			HAC-C				
Anchor channel size			28/15	38/17	40/25	49/30	54/33
Minimum effective anchorage depth	$h_{ef,min}$	[mm]	45	76	79	94	155
Minimum thickness of concrete member	$h_{min}$	[mm]	70	100	100	120	180

### Characteristic resistance for anchor channels

Anchor channel type			HAC-C				
Anchor channel size			28/15	38/17	40/25	49/30	54/33
Tension	$N^{0}_{Rk,s,l}$	[kN]	9,0	18,0	20,0	31,0	55,0
Shear	$V^{0}_{Rk,s,l}$	[kN]	9,0	18,0	20,0	31,0	55,0

### Design resistance for anchor channels

Anchor channel type			HAC-C				
Anchor channel size			28/15	38/17	40/25	49/30	54/33
Tension	$N^{0}_{Rd,s,l}$	[kN]	5,0	10,0	11,1	17,2	30,5
Shear	$V^{0}_{Rd,s,l}$	[kN]	5,0	10,0	11,1	17,2	30,5

**Note:** Values shown in table above are representing only limited amount of the possible failure modes and might be used only for comparison of different products. For detailed design of fixing point please use Hilti PROFIS Anchor Channel software, consult ETA-17/0336 or contact Hilti Engineering team.



**Characteristic resistance for bolts**

Channel bolt diameter		M8	M10	M12	M16	M20
<b>Channel bolt type</b>		<b>HBC-28/15</b>				
Tension	HBC-28/15 4.6	- a)				
	HBC-28/15 8.8	22,4	35,4	44,3	- a)	
	HBC-28/15 A4-50	17,2	- a)			
	HBC-28/15 A4-70	25,6	38,9	51,3	- a)	
Shear	HBC-28/15 4.6	- a)				
	HBC-28/15 8.8	14,6	23,2	33,7	- a)	
	HBC-28/15 A4-50	11,0	- a)			
	HBC-28/15 A4-70	15,4	24,4	35,4	- a)	
<b>Channel bolt type</b>		<b>HBC-38/17</b>				
Tension	HBC-38/17 4.6	- a)	23,2	- a)		
	HBC-38/17 8.8		- a)	35,4	55,8	- a)
	HBC-38/17 A4-70		20,5	47,2	53,0	- a)
Shear	HBC-38/17 4.6	- a)	13,9	- a)		
	HBC-38/17 8.8		- a)	33,7	62,8	- a)
	HBC-38/17 A4-70		24,4	35,4	65,9	- a)
<b>Channel bolt type</b>		<b>HBC-40/22</b>				
Tension	HBC-40/22 4.6	- a)	23,2	- a)		
	HBC-40/22 8.8		- a)	67,4	125,6	- a)
	HBC-40/22 A4-70		20,5	59,0	91,0	- a)
Shear	HBC-40/22 4.6	- a)	13,9	- a)		
	HBC-40/22 8.8		- a)	23,2	33,7	62,8
	HBC-40/22 A4-70		24,4	35,4	65,9	- a)
<b>Channel bolt type</b>		<b>HBC-50/30</b>				
Tension	HBC-50/30 4.6	- a)	- a)			
	HBC-50/30 8.8		- a)	67,4	125,6	147,1
	HBC-50/30 A4-70		- a)	59,0	109,9	121,2
Shear	HBC-50/30 4.6	- a)	- a)			
	HBC-50/30 8.8		- a)	33,7	62,8	101,7
	HBC-50/30 A4-70		- a)	35,4	65,9	102,9

a) Product is not available in standard Hilti portfolio. For additional information please contact Hilti Engineering team.

**Design resistance for bolts**

Channel bolt diameter		M8	M10	M12	M16	M20
<b>Channel bolt type</b>		<b>HBC-28/15</b>				
Tension	HBC-28/15 4.6	- a)				
	HBC-28/15 8.8	14,9	23,6	29,5	- a)	
	HBC-28/15 A4-50	6,0	- a)			
	HBC-28/15 A4-70	13,7	20,8	27,4	- a)	
Shear	HBC-28/15 4.6	- a)				
	HBC-28/15 8.8	11,7	18,6	27,0	- a)	
	HBC-28/15 A4-50	4,6	- a)			
	HBC-28/15 A4-70	9,9	15,6	22,7	- a)	
<b>Channel bolt type</b>		<b>HBC-38/17</b>				
Tension	HBC-38/17 4.6	- a)	11,6	- a)		
	HBC-38/17 8.8		- a)	23,6	37,2	- a)
	HBC-38/17 A4-70		11,0	25,2	28,3	- a)
Shear	HBC-38/17 4.6	- a)	8,3	- a)		
	HBC-38/17 8.8		- a)	27,0	50,2	- a)
	HBC-38/17 A4-70		15,6	22,7	42,2	- a)
<b>Channel bolt type</b>		<b>HBC-40/22</b>				
Tension	HBC-40/22 4.6	- a)	11,6	- a)		
	HBC-40/22 8.8		- a)	44,9	83,7	- a)
	HBC-40/22 A4-70		11,0	31,6	48,7	- a)
Shear	HBC-40/22 4.6	- a)	8,3	- a)		
	HBC-40/22 8.8		- a)	18,6	27,0	50,2
	HBC-40/22 A4-70		15,6	22,7	42,2	- a)
<b>Channel bolt type</b>		<b>HBC-50/30</b>				
Tension	HBC-50/30 4.6	- a)	- a)			
	HBC-50/30 8.8		- a)	44,9	84,5	98,1
	HBC-50/30 A4-70		- a)	31,6	58,8	64,8
Shear	HBC-50/30 4.6	- a)	- a)			
	HBC-50/30 8.8		- a)	27,0	50,2	81,4
	HBC-50/30 A4-70		- a)	22,7	42,4	66,0

a) Product is not available in standard Hilti portfolio. For additional information please contact Hilti Engineering team.

**Note:** combined effects of loads (tension and shear) must be verified additionally. For detailed design of fixing point please use Hilti PROFIS Anchor Channel software, consult ETA-17/0336 or contact Hilti Engineering team.

## Fire resistance

### All data in this section applies to:

- Correct setting (See setting instruction)
- No edge distance and spacing influence
- No influence of bolt type and diameter
- Decisive failure mode – steel failure  
(one of the following: anchor, connection between anchor and channel, local flexure of channel lip)
- Shear load applied perpendicular to the longitudinal axis of the channel
- Partial safety factor for resistance under fire exposure  $\gamma_{M,fi}=1,0$  (in absence of other national regulations)

### Effective anchorage depth

Anchor channel type			HAC-C				
Anchor channel size			28/15	38/17	40/25	49/30	54/33
Minimum effective anchorage depth	$h_{ef,min}$	[mm]	45	76	79	94	155
Minimum thickness of concrete member	$h_{min}$	[mm]	70	100	100	120	180

### Characteristic resistance

Anchor channel type			HAC-C				
Anchor channel size			28/15	38/17	40/25	49/30	54/33
<b>Fire exposure R60</b>							
Tension	Bolt M10	$N_{Rk,s,fi}$	0,8	-	1,7	-	-
=	Bolt M12	=	0,8	-	3,5	3,8	3,8
Shear	Bolt $\geq$ M16	$V_{Rk,s,fi}$	-	1,9	3,5	3,9	3,9
<b>Fire exposure R120</b>							
Tension	Bolt M10	$N_{Rk,s,fi}$	0,5	-	0,9	-	-
=	Bolt M12	=	0,5	-	1,5	1,9	1,9
Shear	Bolt $\geq$ M16	$V_{Rk,s,fi}$	-	1,0	1,5	2,4	2,4

### Design resistance

Anchor channel type			HAC-C				
Anchor channel size			28/15	38/17	40/25	49/30	54/33
<b>Fire exposure R60</b>							
Tension	Bolt M10	$N_{Rd,s,fi}$	0,8	-	1,7	-	-
=	Bolt M12	=	0,8	-	3,5	3,8	3,8
Shear	Bolt $\geq$ M16	$V_{Rd,s,fi}$	-	1,9	3,5	3,9	3,9
<b>Fire exposure R120</b>							
Tension	Bolt M10	$N_{Rd,s,fi}$	0,5	-	0,9	-	-
=	Bolt M12	=	0,5	-	1,5	1,9	1,9
Shear	Bolt $\geq$ M16	$V_{Rd,s,fi}$	-	1,0	1,5	2,4	2,4

**Note:** Values shown in table above are representing only limited amount of the possible failure modes and might be used only for comparison of different products. For detailed design of fixing point please use Hilti PROFIS Anchor Channel software, consult ETA-17/0336 or contact Hilti Engineering team.

**Minimum axis distance of reinforcement**

Anchor channel type		HAC-C				
		28/15	38/17	40/25	49/30	54/33
<b>Fire exposure R60</b>						
Minimum axis distance	a [mm]	35	35	35	50	50
<b>Fire exposure R120</b>						
Minimum axis distance	a [mm]	55	55	55	55	55

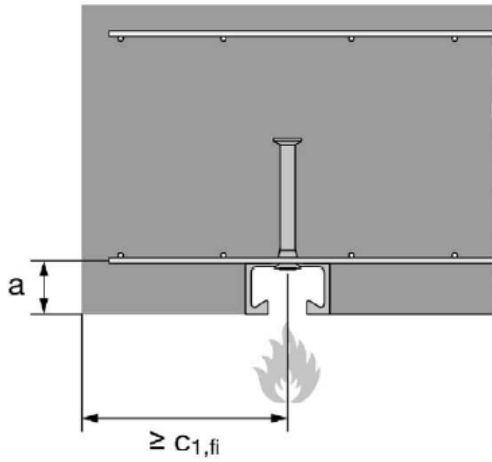
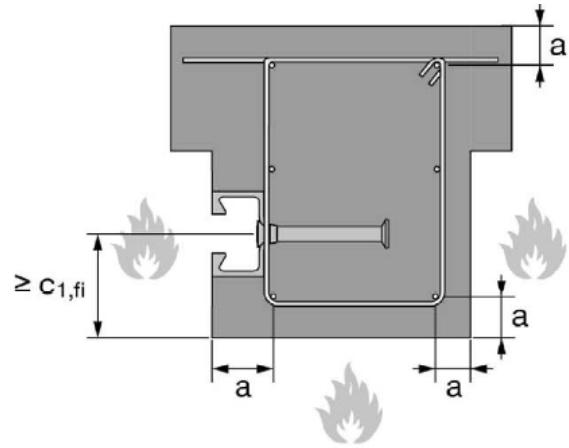
**Fire exposure from one side only**

**Fire exposure from more than one side**

## Materials

### Material quality for anchor channels

Part		Material
Channel profile	HAC-C	Carbon steel 1.0038, 1.0044, 1.0045 according to EN 10025:2005 Carbon steel 1.0976, 1.0979 according to EN 10139:2013 Hot-dip galvanized $\geq 50 \mu\text{m}$ according to EN ISO 10684:2004/AC:2009
	HAC-C A4	Stainless steel 1.4362, 1.4401, 1.4404, 1.4571, 1.4578 according to EN 10088:2005
Anchor	HAC-C	Carbon steel 1.0038, 1.0213, 1.0214 according to EN 10025:2005 Carbon steel 1.5523, 1.5535 according to EN 10263:2002-02 Hot-dip galvanized $\geq 50 \mu\text{m}$ according to EN ISO 10684:2004/AC:2009
	HAC-C A4 <sup>a)</sup>	Stainless steel 1.4362, 1.4401, 1.4404, 1.4571, 1.4578 according to EN 10088:2005

a) Anchors made of carbon steel may also be used if they are welded and their concrete cover is more than 50 mm and the tempering colors are removed

### Material quality for channel bolts

Part		Material
Channel bolts	HBC	Carbon steel grade 4.6 and 8.8 according to ISO 898-1:2013 Electroplated according to EN ISO 4042:1999
	HBC F	Carbon steel grade 4.6 and 8.8 according to ISO 898-1:2013 Hot-dip galvanized $\geq 50 \mu\text{m}$ according to EN ISO 10684:2004/AC:2009
	HBC A4	Stainless steel grade 50 or 70 according to EN ISO 3506:2009
Plain washer	Galvanized	Carbon steel, hardness class A $\geq 200 \text{ HV}$ Electroplated according to EN ISO 4042:1999
	F	Carbon steel, hardness class A $\geq 200 \text{ HV}$ Hot-dip galvanized $\geq 50 \mu\text{m}$ according to EN ISO 10684:2004/AC:2009
	A4	Stainless steel 1.4401, 1.4404, 1.4571, 1.4578 according to EN 10088:2005
Hexagonal nut <sup>a)</sup>	Galvanized	Property class 5 or 8 according to EN ISO 898-2:2012 Electroplated according to EN ISO 4042:1999
	F	Property class 5 or 8 according to EN ISO 898-2:2012 Hot-dip galvanized $\geq 50 \mu\text{m}$ according to EN ISO 10684:2004/AC:2009
	A4	Property class 50, 70 or 80 according to EN ISO 3506:2009

a) Hexagonal nuts according to DIN 934: 1987-10 for channel bolts made from carbon steel (4.6) and stainless steel

### Mechanical properties

Part		HAC-C / HBC		
Nominal tensile strength	Carbon steel 4.6	$f_{uk}$	[N/mm <sup>2</sup> ]	400
	Carbon steel 8.8			800 / 830 <sup>a)</sup>
	Stainless steel A4-50			500
	Stainless steel A4-70			700
Yield strength	Carbon steel 4.6	$f_{yk}$	[N/mm <sup>2</sup> ]	240
	Carbon steel 8.8			640 / 660 <sup>a)</sup>
	Stainless steel A4-50			210
	Stainless steel A4-70			450

a) Material properties according to EN ISO 898-1

**Corrosion class**

Class / Mark	Material / Coating type
G	Carbon steel, electroplated
F (HDG)	Carbon steel, hot-dip galvanized
R (A4)	Stainless steel

**Nomenclature of HAC-C anchor channels (example)**

Hilti anchor channel type	Profile type and size	Channel length	Finish or material
①	②	③	④
HAC-C	40/25	300	F (HDG)

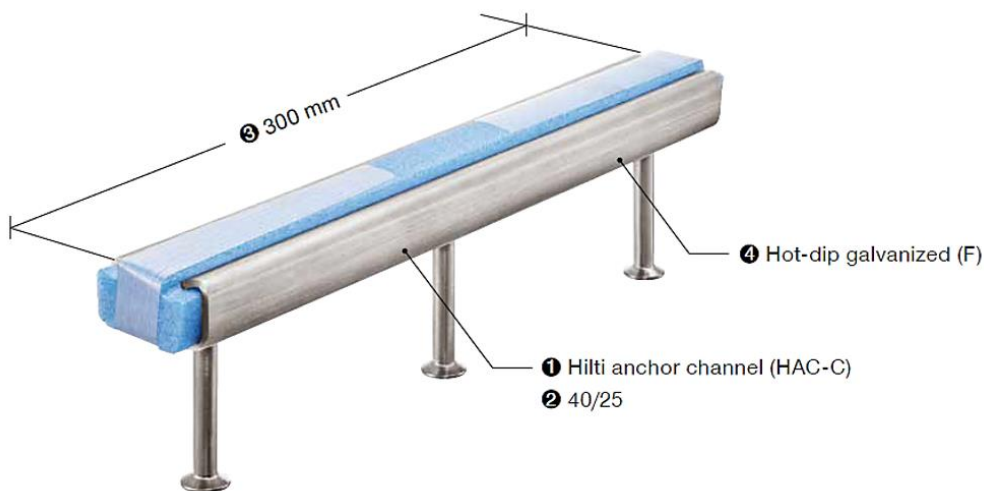
**HAC-C 40/25 300F**

**Nomenclature of HBC channel bolts (example)**

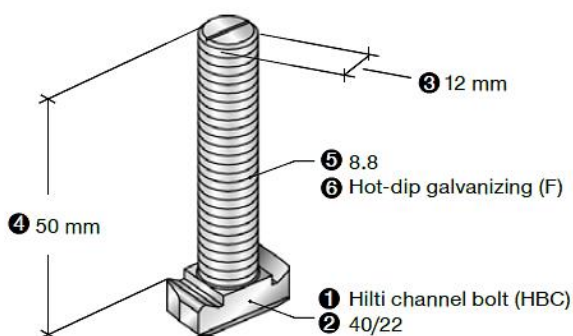
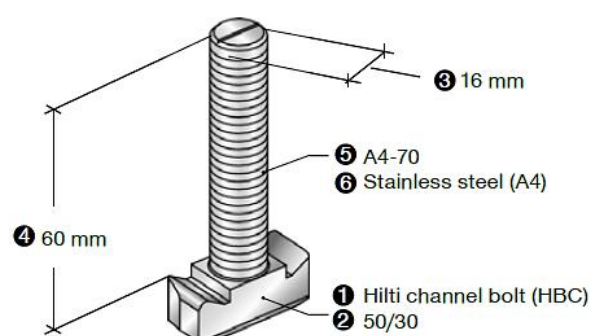
Hilti channel bolt	Bolt type	Diameter	Bolt length	Steel grade	Finish or material
①	②	③	④	⑤	⑥
HBC	40/22	M12	50	8.8	F (HDG)
HBC	50/30	M16	60	A4-70	-

**HBC-40/22 M12x50 8.8 F**

**HBC-50/30 M12x60 A4-70**

## Dimensions of anchor channels

### Dimensions of channel profile

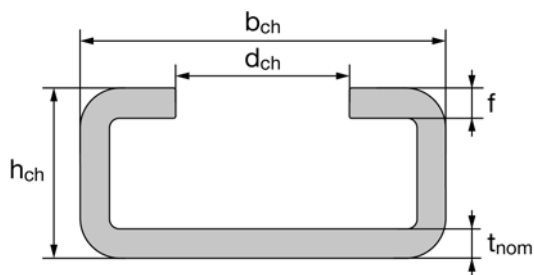
Anchor channel type		HAC-C				
Anchor channel size		28/15	38/17	40/25	49/30	54/33
Channel width	$b_{ch}$ [mm]	28,0	38,0	40,0	50,0	53,5
Channel height	$h_{ch}$ [mm]	15,5	17,3	25,0	30,0	33,0
Nominal thickness	$t_{nom}$ [mm]	2,3	3,0	2,75	3,25	5,0
Width of channel opening	$d_{ch}$ [mm]	12,0	18,0	18,0	22,0	21,5
Height of channel lips	$f$ [mm]	2,3	3,0	5,6	7,4	8,0
Moment of inertia	$I_y$ [mm <sup>4</sup> ]	4277	8224	20122	43105	74706



HAC-C 28/15, HAC-C 38/17

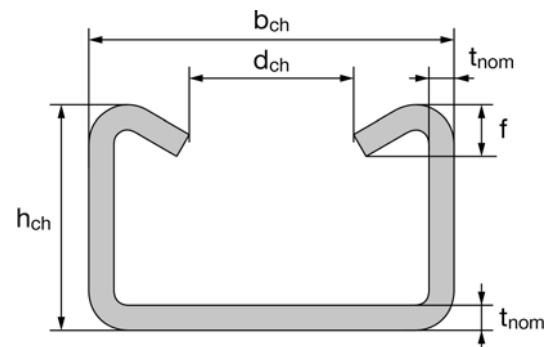

HAC-C 40/25, HAC-C 49/30, HAC-C 54/33

### Dimensions of anchors

Anchor channel type		HAC-C				
Anchor channel size		28/15	38/17	40/25	49/30	54/33
Minimum anchor length	min. $l_a$ [mm]	31,0	60,8	56,0	66,0	124,5
Diameter of anchor	$d_a$ [mm]	6,0	8,0	8,0	10,0	11,0
Diameter of round anchor head	$d_h$ [mm]	12,0	16,0	16,0	20,0	24,3
Thickness of round anchor head	$t_h$ [mm]	1,3	2,0	2,0	2,2	2,5
Area of round anchor head	$A_h$ [mm]	85	151	151	236	369

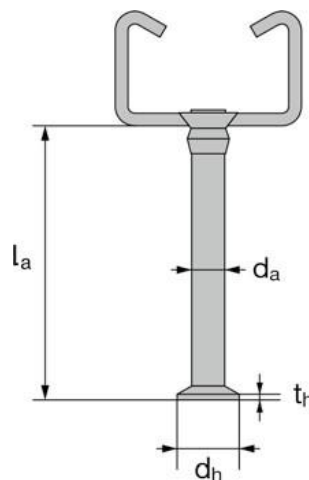

## Dimensions of channel bolts

### Dimensions of channel bolts

Channel bolt type			HBC-28/15		
Appropriate anchor channel			HAC-C 28/15		
Nominal diameter	d	[mm]	8,0	10,0	12,0
Width (1)	b <sub>1</sub>	[mm]	10,1	10,1	11,0
Width (2)	b <sub>2</sub>	[mm]	22,2	22,2	22,2
Thickness	k	[mm]	5,0	5,0	6,0

### Dimensions of channel bolts

Channel bolt type			HBC-38/17		
Appropriate anchor channel			HAC-C 38/17		
Nominal diameter	d	[mm]	10,0	12,0	16,0
Width (1)	b <sub>1</sub>	[mm]	13,0	13,0	16,0
Width (2)	b <sub>2</sub>	[mm]	30,5	30,5	30,5
Thickness	k	[mm]	6,0	7,0	7,0

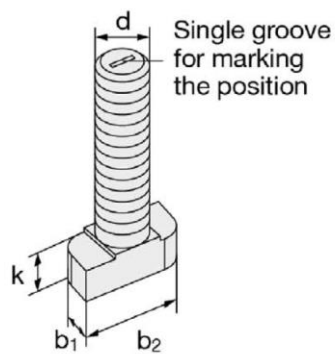

HBC-28/15, HBC-38/17



**Dimensions of channel bolts**

Channel bolt type			HBC-40/22		
Appropriate anchor channel			HAC-C 40/25		
Nominal diameter	d	[mm]	10,0	12,0	16,0
Width (1)	b <sub>1</sub>	[mm]	14,0	14,0	17,0
Width (2)	b <sub>2</sub>	[mm]	33,0	33,0	33,0
Thickness	k	[mm]	10,5	11,5	11,5

**Dimensions of channel bolts**

Channel bolt type			HBC-50/30		
Appropriate anchor channel			HAC-C 49/30 ; HAC-C 54/33		
Nominal diameter	d	[mm]	12,0	16,0	20,0
Width (1)	b <sub>1</sub>	[mm]	17,0	17,0	21,0
Width (2)	b <sub>2</sub>	[mm]	42,0	42,0	42,0
Thickness	k	[mm]	14,5	15,5	15,5

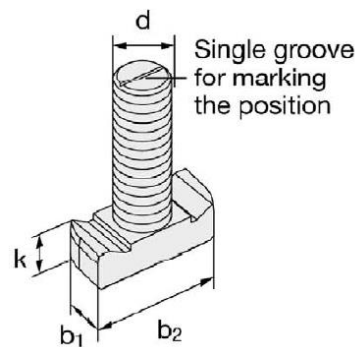
**HBC-40/22, HBC-50/30**

**Setting information**
**Setting details for anchor channels**

Anchor channel type			HAC-C				
Anchor channel size			28/15	38/17	40/25	49/30	54/33
Minimum effective embedment depth	$h_{ef,min}$	[mm]	45	76	79	94	155
Nominal embedment depth	$h_{nom}$	[mm]	48,5	81	96	99	161
Minimum spacing	$s_{min}$	[mm]	50	100			
Maximum spacing	$s_{max}$	[mm]	200		250		
End spacing	$x$	[mm]	25 <sup>a)</sup>				
Minimum channel length	$l_{min}$	[mm]	100	150			
Minimum edge distance	$c_{min}$	[mm]	40	50		75	100
Minimum thickness of concrete member	$h_{min}$	[mm]	70	100		120	180

a) The end spacing may be increased from 25 mm to 35 mm

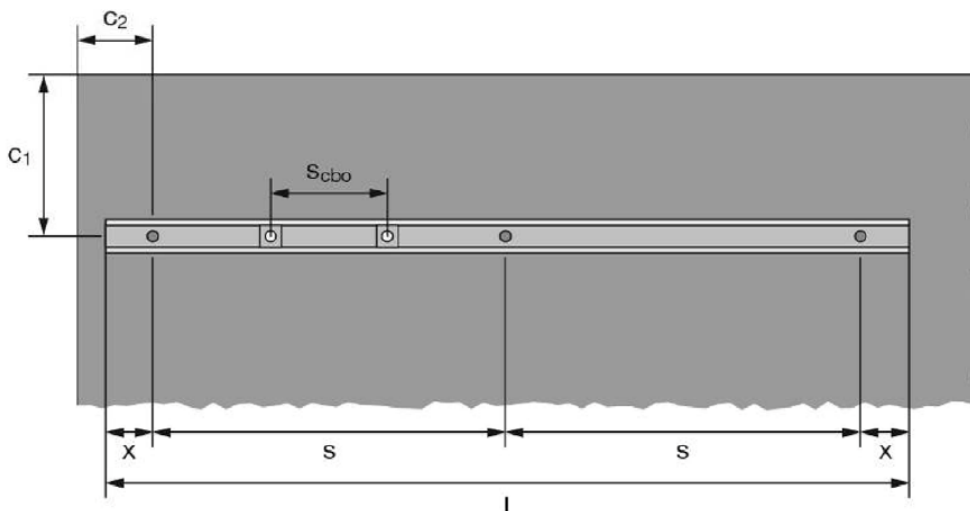

**Setting details for channel bolts**

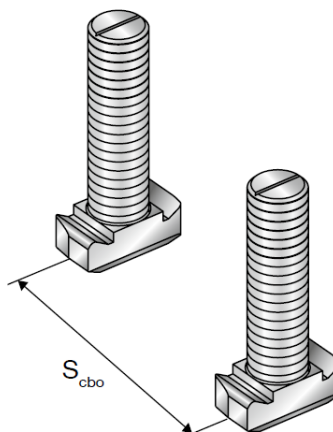
Anchor channel size			M8	M10	M12	M16	M20
Minimum spacing between channel bolts	$s_{cbo,min}$	[mm]	40	50	60	80	100

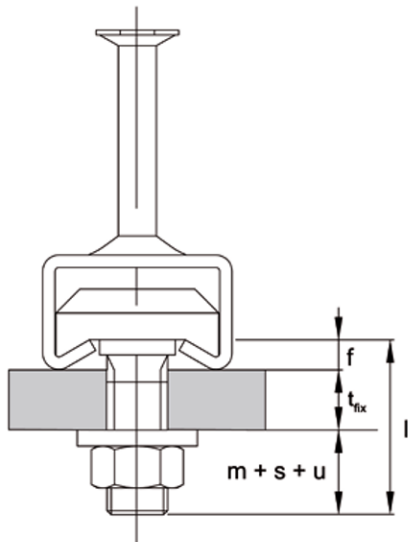

**Determination of the minimum required T-bolt length**

Anchor channel type		HAC-C				
		28/15	38/17	40/25	49/30	54/33
Anchor channel size		28/15	38/17	40/25	49/30	54/33
Channel bolt type		HBC 28/15	HBC 38/17	HBC 40/22	HBC 50/30	HBC 50/30
Height of channel lip	f [mm]	2,3	3,0	6,0	7,5	8,0
Thickness of nut, washer and channel bolt projection	Bolt M10	13,9	13,9	-	-	-
	Bolt M12	17,3	17,3	13,9	17,3	17,3
	Bolt M16	-	21,8	17,3	21,8	21,8
	Bolt M20	-	-	-	27,0	27,0

**Dimensions**

l [mm]	nominal length of channel bolt
$t_{fix}$ [mm]	fastenable thickness (thickness of the attached part)
f [mm]	height of channel lip
m [mm]	thickness of the nut (ISO 4032)
s [mm]	thickness of the washer
u [mm]	channel bolt projection

Required T-Bolt length :  $l = t_{fix} + f + (m + s + u)$

## Setting instructions

\*For detailed information on installation see instruction for use given with the package of the product

### Setting instruction for anchor channel

#### 1. Correct selection of anchor channel

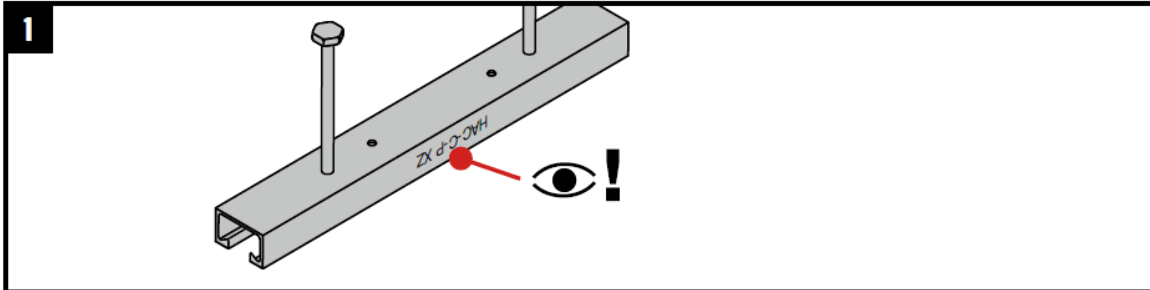

#### 2. Cut the anchor channel (if necessary) with required end spacing

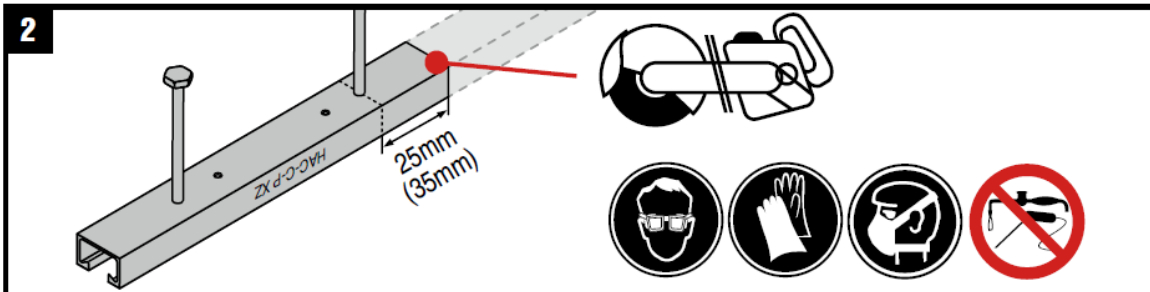

#### 3. Position of anchor channel flush with the surface

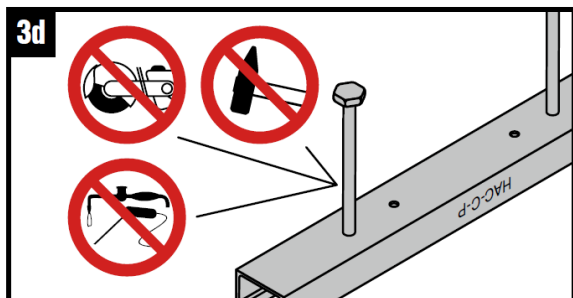
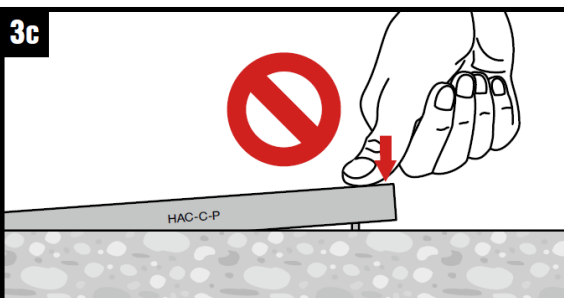
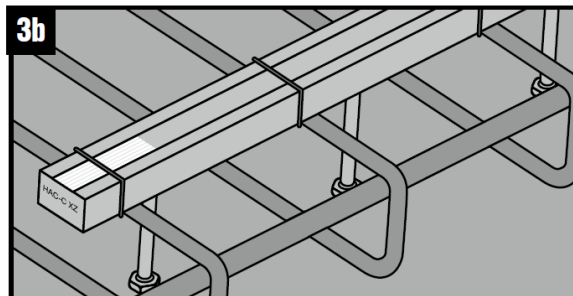
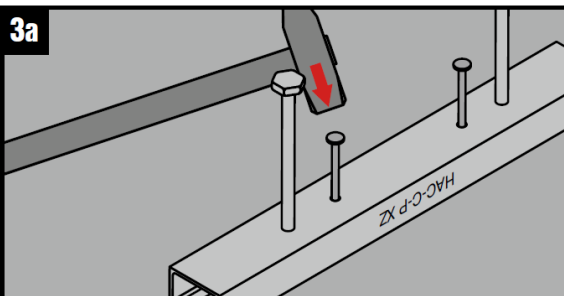

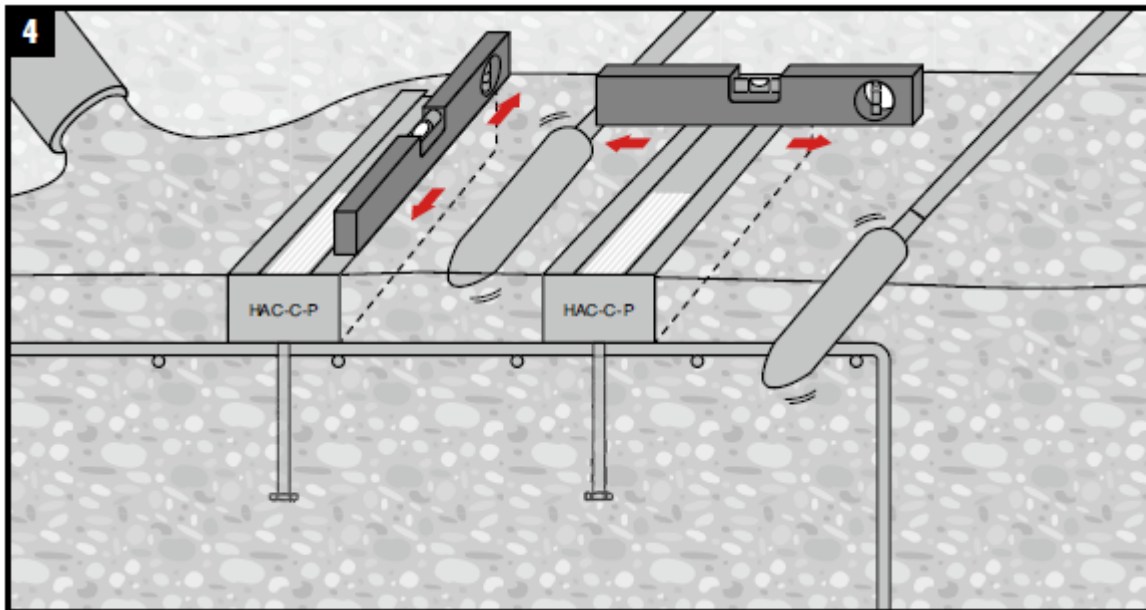
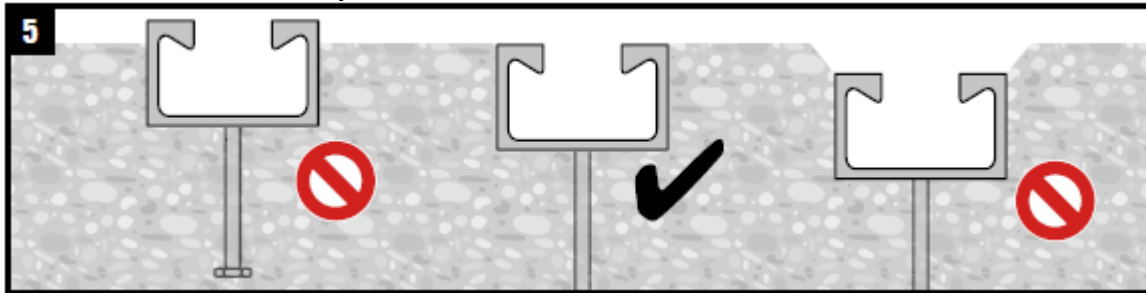
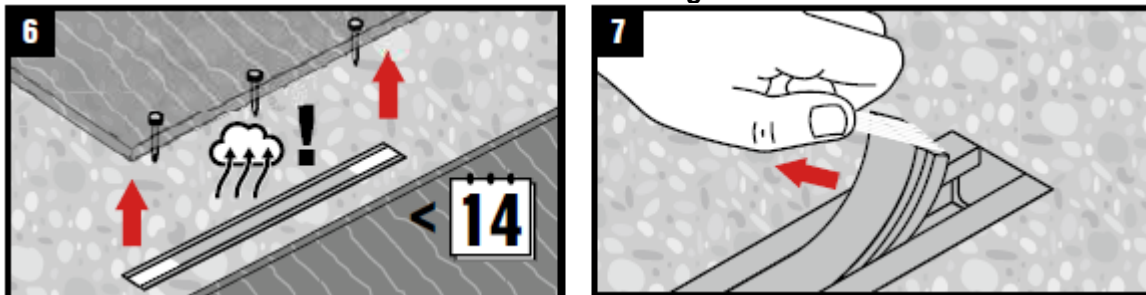
**4. Pouring the concrete****5. Check anchor channels position****6. Remove the formwork and foam filler after hardening of concrete**

\*For detailed information on installation see instruction for use given with the package of the product

### Setting instruction for channel bolts

#### 1. Correct selection of channel bolt

	HBC-28/15	HAC-C 28/15
	HBC-38/17	HAC-C 38/17
	HBC-40/22	HAC-C-P 40/22, HAC-C-P 40L, HAC-C 40/22, HAC-C 40/25
	HBC-50/30	HAC-C-P 50/30, HAC-C-P 50L, HAC-C 49/30, HAC-C 50/30
	HBC-52/34	HAC-C 52/34, HAC-C 54/33
		HAC-HW53, HAC-C 52/34

#### 2-5. Installation of the channel bolt

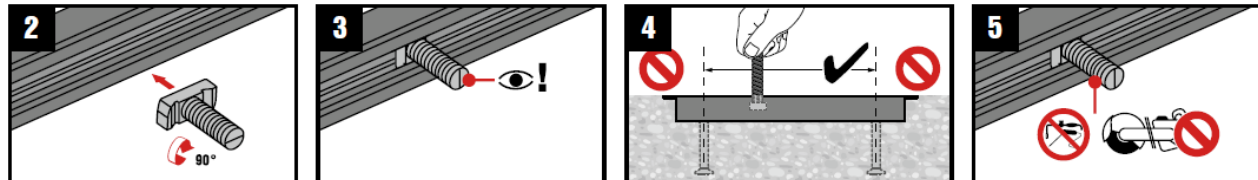

#### 6. Installation of the fixture

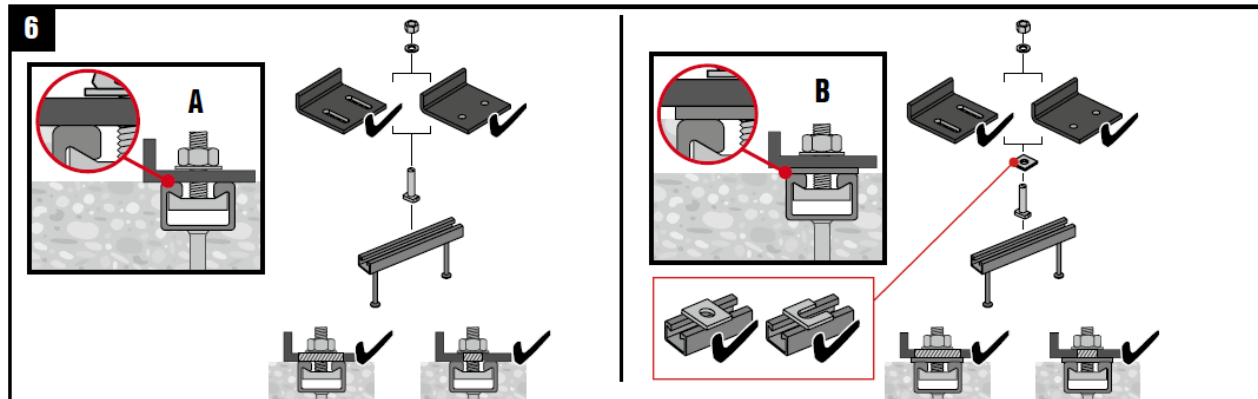

#### 7. Apply the installation torque $T_{inst}$

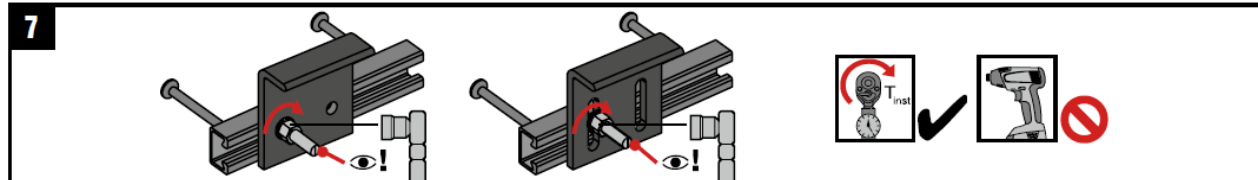

Channel bolt		$T_{inst}$ [Nm]				
		4.6, 8.8, A4-50, A4-70	4.6	8.8	A4-50	A4-70
HBC-28/15	M8	7	-	20	7	15
	M10	10	-	40	-	30
	M12	13	-	60	-	50
HBC-38/17	M10	15	13	15	-	22
	M12	25	-	45	-	50
	M16	40	-	100	-	90
HBC-40/22	M10	15	13	15	-	22
	M12	25	-	45	-	50
	M16	30	-	100	-	90
HBC-50/30	M12	25	-	45	-	50
	M16	55	-	100	-	130
	M20	55	-	360	-	250
HBC-52/34	M20	55	-	360	-	-

# HAC-C Hot rolled

Cast-in anchor channels in standard sizes and lengths for a variety of applications

## Anchor channel version



HBC-40/22  
HBC-50/30

HAC-C 40/22  
HAC-C 50/30  
HAC-C 52/34

## Benefits

- Hot-rolled anchor channels with thick, robust profiles - high resistance to loads
- LDPE foam filler with grip loop - keeps channel clear of concrete and quickly removes in one piece
- Available in three sizes - HAC-C 40/22, HAC-C 50/30, HAC-C 52/34
- ETA and fire safety documents available
- Available in stainless steel and hot-dip galvanized versions - for optimal corrosion protection depending on the environmental conditions

## Base material



Concrete  
(non-cracked)

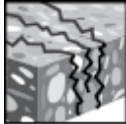

Concrete  
(cracked)

## Load conditions

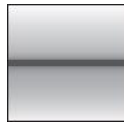

Static/  
quasi-static

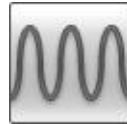

Fatigue



Fire  
resistance

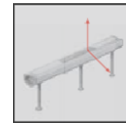

Static  
2D loading



Static  
3D loading

## Other information



European  
Technical  
Assessment



CE conformity



PROFIS Anchor  
channel design  
Software

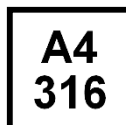

Corrosion  
resistance

## Approvals / certificates

Description	Authority / Laboratory	No. / date of issue
European technical assessment <sup>a)</sup>	DIBt, Berlin	ETA-17/0336 of 09.11.2020

a) All data given in this section according to ETA-17/0336 of 09.11.2020

## Static and quasi-static loading

### All data in this section applies to:

- Correct setting (See setting instruction)
- No edge distance and spacing influence
- No influence of bolt type and diameter
- Decisive failure mode – local flexure of channel lips
- Shear load applied perpendicular to the longitudinal axis of the channel

### Effective anchorage depth

Anchor channel type		HAC-C		
Anchor channel size		40/22	50/30	52/34
Minimum effective anchorage depth	$h_{ef,min}$ [mm]	79	94	155
Minimum thickness of concrete member	$h_{min}$ [mm]	100	105	165

### Characteristic resistance for anchor channels

Anchor channel type		HAC-C		
Anchor channel size		40/22	50/30	52/34
Tension	$N_{Rk,s,l}^0$ [kN]	47,9	50,5	65,0
Shear	$V_{Rk,s,l}^0$ [kN]	55,0	91,7	71,5

### Design resistance for anchor channels

Anchor channel type		HAC-C		
Anchor channel size		40/22	50/30	52/34
Tension	$N_{Rd,s,l}^0$ [kN]	26,6	28,1	36,1
Shear	$V_{Rd,s,l}^0$ [kN]	30,6	50,9	39,7

**Note:** Values shown in table above are representing only limited amount of the possible failure modes and might be used only for comparison of different products. For detailed design of fixing point please use Hilti PROFIS Anchor Channel software, consult ETA-17/0336 or contact Hilti Engineering team.



**Characteristic resistance for bolts**

Channel bolt diameter		M8	M10	M12	M16	M20
<b>Channel bolt type</b>		<b>HBC-40/22</b>				
Tension	HBC-40/22 4.6	- a)	23,2	- a)		
	HBC-40/22 8.8		- a)	67,4	125,6	- a)
	HBC-40/22 A4-70		20,5	59,0	91,0	
Shear	HBC-40/22 4.6	- a)	13,9	- a)		
	HBC-40/22 8.8		23,2	33,7	62,8	- a)
	HBC-40/22 A4-70		24,4	35,4	65,9	
<b>Channel bolt type</b>		<b>HBC-50/30</b>				
Tension	HBC-50/30 4.6	- a)	- a)			
	HBC-50/30 8.8		- a)	67,4	125,6	147,1
	HBC-50/30 A4-70		- a)	59,0	109,9	121,2
Shear	HBC-50/30 4.6	- a)	- a)			
	HBC-50/30 8.8		- a)	33,7	62,8	101,7
	HBC-50/30 A4-70		- a)	35,4	65,9	102,9

a) Product is not available in standard Hilti portfolio. For additional information please contact Hilti Engineering team.

**Design resistance for bolts**

Channel bolt diameter		M8	M10	M12	M16	M20
<b>Channel bolt type</b>		<b>HBC-40/22</b>				
Tension	HBC-40/22 4.6	- a)	11,6	- a)		
	HBC-40/22 8.8		- a)	44,9	83,7	- a)
	HBC-40/22 A4-70		11,0	31,6	48,7	
Shear	HBC-40/22 4.6	- a)	8,3	- a)		
	HBC-40/22 8.8		18,6	27,0	50,2	- a)
	HBC-40/22 A4-70		15,6	22,7	42,2	
<b>Channel bolt type</b>		<b>HBC-50/30</b>				
Tension	HBC-50/30 4.6	- a)	- a)			
	HBC-50/30 8.8		- a)	44,9	84,5	98,1
	HBC-50/30 A4-70		- a)	31,6	58,8	64,8
Shear	HBC-50/30 4.6	- a)	- a)			
	HBC-50/30 8.8		- a)	27,0	50,2	81,4
	HBC-50/30 A4-70		- a)	22,7	42,4	66,0

b) Product is not available in standard Hilti portfolio. For additional information please contact Hilti Engineering team.

**Note:** combined effects of loads (tension and shear) must be verified additionally. For detailed design of fixing point please use Hilti PROFIS Anchor Channel software, consult ETA-17/0336 or contact Hilti Engineering team.

## Fire resistance

### All data in this section applies to:

- Correct setting (See setting instruction)
- No edge distance and spacing influence
- No influence of bolt type and diameter
- Decisive failure mode – steel failure  
(one of the following: anchor, connection between anchor and channel, local flexure of channel lip)
- Shear load applied perpendicular to the longitudinal axis of the channel
- Partial safety factor for resistance under fire exposure  $\gamma_{M,fi}=1,0$  (in absence of other national regulations)

### Effective anchorage depth

Anchor channel type			HAC-C		
Anchor channel size			40/22	50/30	52/34
Minimum effective anchorage depth	$h_{ef,min}$	[mm]	79	94	155
Minimum thickness of concrete member	$h_{min}$	[mm]	100	105	165

### Characteristic resistance

Anchor channel type			HAC-C		
Anchor channel size			40/22	50/30	52/34
<b>Fire exposure R60</b>					
Tension	Bolt M10	$N_{Rk,s,fi}$	1,7	-	-
=	Bolt M12	=	3,5	3,8	3,8
Shear	Bolt $\geq$ M16	$V_{Rk,s,fi}$	3,5	3,9	3,9
<b>Fire exposure R120</b>					
Tension	Bolt M10	$N_{Rk,s,fi}$	0,9	-	-
=	Bolt M12	=	1,5	1,9	1,9
Shear	Bolt $\geq$ M16	$V_{Rk,s,fi}$	1,5	2,4	2,4

### Design resistance

Anchor channel type			HAC-C		
Anchor channel size			40/22	50/30	52/34
<b>Fire exposure R60</b>					
Tension	Bolt M10	$N_{Rd,s,fi}$	1,7	-	-
=	Bolt M12	=	3,5	3,8	3,8
Shear	Bolt $\geq$ M16	$V_{Rd,s,fi}$	3,5	3,9	3,9
<b>Fire exposure R120</b>					
Tension	Bolt M10	$N_{Rd,s,fi}$	0,9	-	-
=	Bolt M12	=	1,5	1,9	1,9
Shear	Bolt $\geq$ M16	$V_{Rd,s,fi}$	1,5	2,4	2,4

**Note:** Values shown in table above are representing only limited amount of the possible failure modes and might be used only for comparison of different products. For detailed design of fixing point please use Hilti PROFIS Anchor Channel software, consult ETA-17/0336 or contact Hilti Engineering team.

**Minimum axis distance of reinforcement**

Anchor channel type		HAC-C		
		40/22	50/30	52/34
<b>Fire exposure R60</b>				
Minimum axis distance	a [mm]	35	50	50
<b>Fire exposure R120</b>				
Minimum axis distance	a [mm]	55	55	55

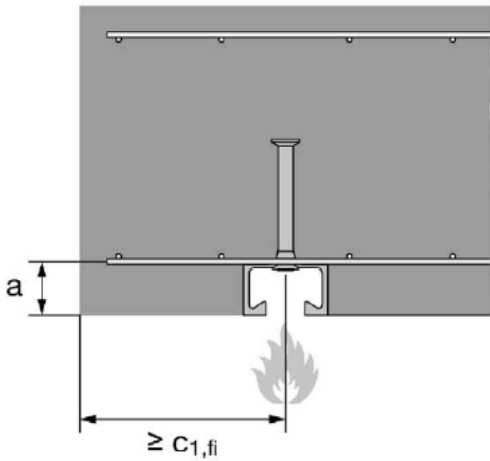
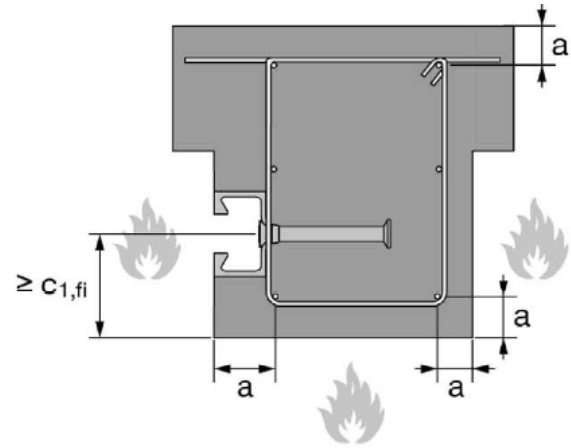
**Fire exposure from one side only**

**Fire exposure from more than one side**

## Fatigue resistance

### All data in this section applies to:

- Correct setting (See setting instruction)
- No edge distance and spacing influence
- No influence of bolt type and diameter
- Shear load applied perpendicular to the longitudinal axis of the channel

### Characteristic resistance under fatigue load

Anchor channel type		HAC-C	
Anchor channel size		52/34	
Characteristic resistance under fatigue tension load after n load cycles without static preload ( $N_{Ed} = 0$ )	$\leq 10^4$	$\Delta N_{Rk,s,0,n}$ [kN]	24,3
	$\leq 10^5$		12,5
	$\leq 10^6$		7,1
	$\leq 2 \cdot 10^6$		6,4
	$\leq 5 \cdot 10^6$		5,9
	$\leq 10^8$		5,7
	$> 10^8$		5,5
Reduction factor after n load cycles without static preload ( $N_{Ed} = 0$ ) for: $\Delta N_{Rk,p,0,n} = \eta_{c,fat} \cdot N_{Rk,p}$ $\Delta N_{Rk,c,0,n} = \eta_{c,fat} \cdot N_{Rk,c}$	$\leq 10^4$	$\eta_{c,fat}$ [-]	0,736
	$\leq 10^5$		0,665
	$\leq 10^6$		0,600
	$\leq 2 \cdot 10^6$		0,582
	$\leq 5 \cdot 10^6$		0,559
	$\leq 6 \cdot 10^7$		0,500
	$> 10^7$		0,500
Characteristic fatigue limit resistance without static preload ( $N_{Ed} = 0$ )	$(n \rightarrow \infty)$	$\Delta N_{Rk,s,0,\infty}$ [kN]	5,5
Reduction factor for fatigue limit resistance without static preload ( $N_{Ed} = 0$ ) for: $\Delta N_{Rk,p,0,n} = \eta_{c,fat} \cdot N_{Rk,p}$ $\Delta N_{Rk,c,0,n} = \eta_{c,fat} \cdot N_{Rk,c}$	$(n \rightarrow \infty)$	$\eta_{c,fat}$ [-]	0,5

**Note:** Values shown in table above are representing only limited amount of the possible failure modes and might be used only for comparison of different products. For detailed design of fixing point please use Hilti PROFIS Anchor Channel software, consult ETA-17/0336 or contact Hilti Engineering team.

**Materials**
**Material quality for anchor channels**

Part		Material
Channel profile	HAC-C	Carbon steel 1.0038, 1.0044, 1.0045 according to EN 10025:2005 Carbon steel 1.0976, 1.0979 according to EN 10139:2013 Hot-dip galvanized $\geq 50 \mu\text{m}$ according to EN ISO 10684:2004/AC:2009
	HAC-C A4	Stainless steel 1.4362, 1.4401, 1.4404, 1.4571, 1.4578 according to EN 10088:2005
Anchor	HAC-C	Carbon steel 1.0038, 1.0213, 1.0214 according to EN 10025:2005 Carbon steel 1.5523, 1.5535 according to EN 10263:2002-02 Hot-dip galvanized $\geq 50 \mu\text{m}$ according to EN ISO 10684:2004/AC:2009
	HAC-C A4 <sup>a)</sup>	Stainless steel 1.4362, 1.4401, 1.4404, 1.4571, 1.4578 according to EN 10088:2005

a) Anchors made of carbon steel may also be used if they are welded and their concrete cover is more than 50 mm and the tempering colors are removed

**Material quality for channel bolts**

Part		Material
Channel bolts	HBC	Carbon steel grade 4.6 and 8.8 according to ISO 898-1:2013 Electroplated according to EN ISO 4042:1999
	HBC F	Carbon steel grade 4.6 and 8.8 according to ISO 898-1:2013 Hot-dip galvanized $\geq 50 \mu\text{m}$ according to EN ISO 10684:2004/AC:2009
	HBC A4	Stainless steel grade 50 or 70 according to EN ISO 3506:2009
Plain washer	Galvanized	Carbon steel, hardness class A $\geq 200 \text{ HV}$ Electroplated according to EN ISO 4042:1999
	F	Carbon steel, hardness class A $\geq 200 \text{ HV}$ Hot-dip galvanized $\geq 50 \mu\text{m}$ according to EN ISO 10684:2004/AC:2009
	A4	Stainless steel 1.4401, 1.4404, 1.4571, 1.4578 according to EN 10088:2005
Hexagonal nut <sup>a)</sup>	Galvanized	Property class 5 or 8 according to EN ISO 898-2:2012 Electroplated according to EN ISO 4042:1999
	F	Property class 5 or 8 according to EN ISO 898-2:2012 Hot-dip galvanized $\geq 50 \mu\text{m}$ according to EN ISO 10684:2004/AC:2009
	A4	Property class 50, 70 or 80 according to EN ISO 3506:2009

a) Hexagonal nuts according to DIN 934: 1987-10 for channel bolts made from carbon steel (4.6) and stainless steel

**Mechanical properties**

Part		HAC-C / HBC		
Nominal tensile strength	Carbon steel 4.6	$f_{uk}$	[N/mm <sup>2</sup> ]	400
	Carbon steel 8.8			800 / 830 <sup>a)</sup>
	Stainless steel A4-50			500
	Stainless steel A4-70			700
Yield strength	Carbon steel 4.6	$f_{yk}$	[N/mm <sup>2</sup> ]	240
	Carbon steel 8.8			640 / 660 <sup>a)</sup>
	Stainless steel A4-50			210
	Stainless steel A4-70			450

a) Material properties according to EN ISO 898-1

**Corrosion class**

Class / Mark	Material / Coating type
G	Carbon steel, electroplated
F (HDG)	Carbon steel, hot-dip galvanized
R (A4)	Stainless steel

**Nomenclature of HAC-C anchor channels (example)**

Hilti anchor channel type	Profile type and size	Channel length	Finish or material
①	②	③	④
HAC-C	40/22	300	F (HDG)

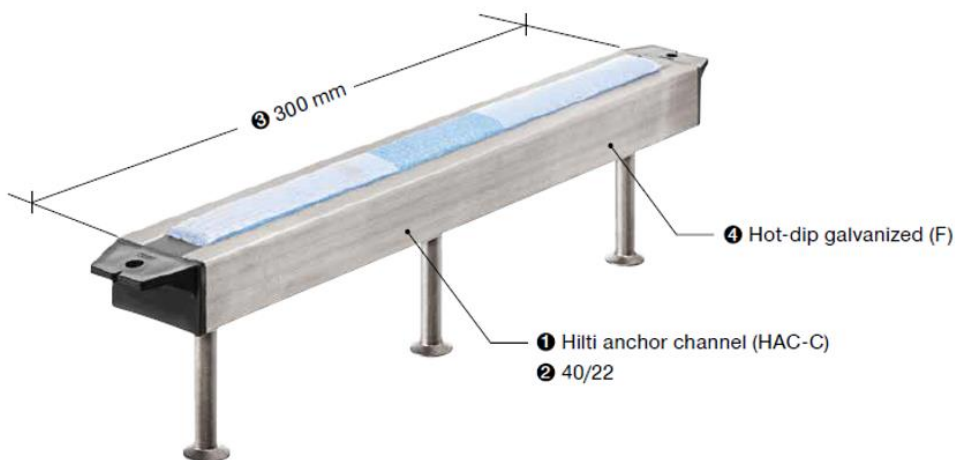
**HAC-C 40/22 300F**

**Nomenclature of HBC channel bolts (example)**

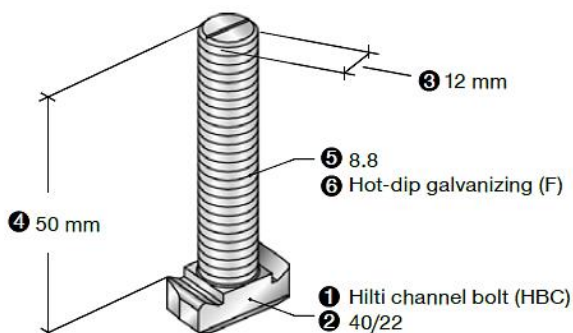
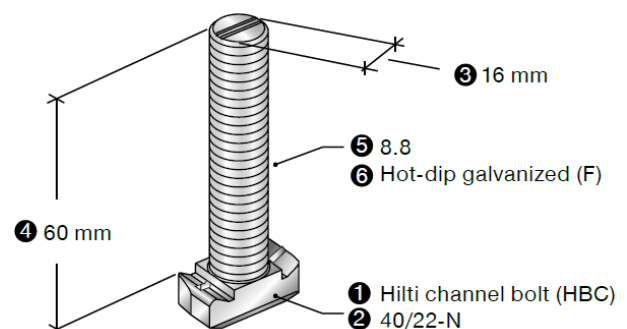
Hilti channel bolt	Bolt type	Diameter	Bolt length	Steel grade	Finish or material
①	②	③	④	⑤	⑥
HBC	40/22	M12	50	8.8	F (HDG)
HBC	40/22-N	M16	60	8.8	F (HDG)

**HBC-40/22 M12x50 8.8 F  
(standard bolt)**

**HBC-40/22 M16x60 8.8 F  
(notched bolt)**

## Dimensions of anchor channels

### Dimensions of channel profile

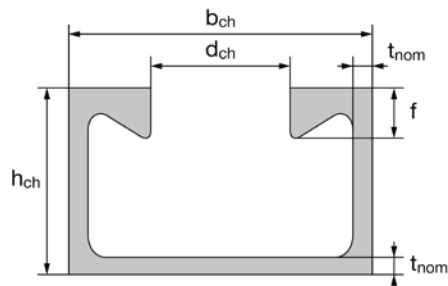
Anchor channel type		HAC-C		
Anchor channel size		40/22	50/30	52/34
Channel width	$b_{ch}$ [mm]	40,1	49,6	52,5
Channel height	$h_{ch}$ [mm]	23,0	30,0	34,0
Nominal thickness	$t_{nom}$ [mm]	2,7	3,2	4,0
Width of channel opening	$d_{ch}$ [mm]	18,0	22,5	22,5
Height of channel lips	$f$ [mm]	6,0	8,1	11,5
Moment of inertia	$I_y$ [mm <sup>4</sup> ]	21504	57781	97606



HAC-C 40/22, HAC-C 50/30, HAC-C 52/34

### Dimensions of anchors

Anchor channel type		HAC-C		
Anchor channel size		40/22	50/30	52/34
<b>Version with welded I-anchor</b>				
Minimum anchor length	min. $l_a$ [mm]	62,0	69,0	125,0
Web thickness	$t_w$ [mm]	5,0	5,0	6,0
Width of the head	$b_h$ [mm]	20,0	20,0	25,0
Head thickness	$t_h$ [mm]	5,0	5,0	5,0
Width (cutting length)	$w_A$ [mm]	20,0	25,0	40,0
Area of the head	$A_h$ [mm]	300	375	760
<b>Version with round anchor</b>				
Minimum anchor length	min. $l_a$ [mm]	58,0	65,0	123,5
Diameter of anchor	$d_a$ [mm]	8,0	10,0	11,0
Diameter of round anchor head	$d_h$ [mm]	16,0	20,0	24,3
Thickness of round anchor head	$t_h$ [mm]	2,0	2,2	2,5
Area of round anchor head	$A_h$ [mm]	151	236	369

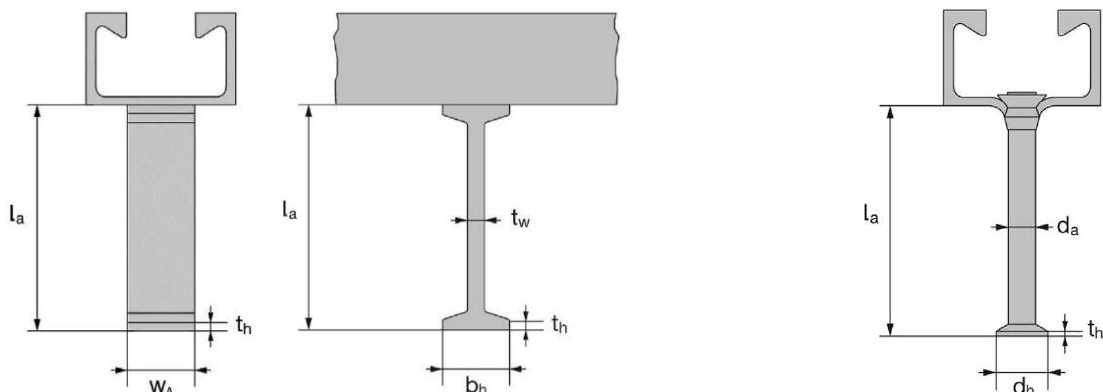

Version with welded I-Anchor

Version with round anchor

## Dimensions of channel bolts

### Dimensions of channel bolts

Channel bolt type			HBC-40/22			HBC-40/22-N
Appropriate anchor channel			HAC-C 40/22			
Nominal diameter	d	[mm]	10,0	12,0	16,0	16,0
Width (1)	b <sub>1</sub>	[mm]	14,0	14,0	17,0	17,0
Width (2)	b <sub>2</sub>	[mm]	33,0	33,0	33,0	33,0
Thickness	k	[mm]	10,5	11,5	11,5	11,5

### Dimensions of channel bolts

Channel bolt type			HBC-50/30			HBC-50/30-N	
Appropriate anchor channel			HAC-C 50/30 ; HAC-C 52/34				
Nominal diameter	d	[mm]	12,0	16,0	20,0	16,0	20,0
Width (1)	b <sub>1</sub>	[mm]	17,0	17,0	21,0	21,0	21,0
Width (2)	b <sub>2</sub>	[mm]	42,0	42,0	42,0	42,0	42,0
Thickness	k	[mm]	14,5	15,5	15,5	15,5	15,5

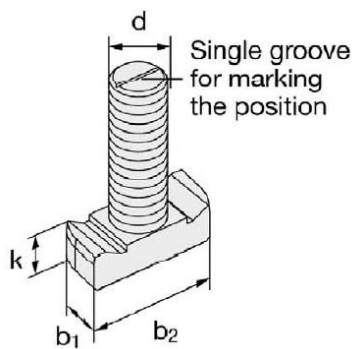

HBC-40/22, HBC-50/30

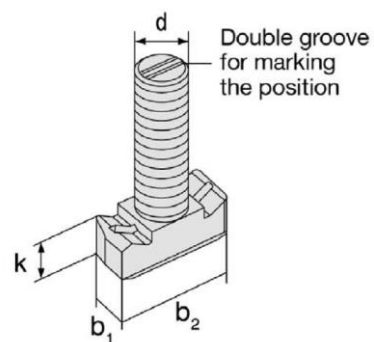

HBC-40/22-N, HBC-50/30-N



**Setting information**
**Setting details for anchor channels**

Anchor channel type		HAC-C		
Anchor channel size		40/22	50/30	52/34
Minimum effective embedment depth	$h_{ef,min}$ [mm]	79	94	155
Nominal embedment depth	$h_{nom}$ [mm]	81	96,2	157,5
Minimum spacing	$s_{min}$ [mm]	100		
Maximum spacing	$s_{max}$ [mm]	250		
End spacing	$x$ [mm]	25 <sup>a)</sup>	35 <sup>b)</sup>	
Minimum channel length	$l_{min}$ [mm]	150	150	170 <sup>c)</sup>
Minimum edge distance	$c_{min}$ [mm]	50	75	
Minimum thickness of concrete member	$h_{min}$ [mm]	100	105	165

a) The end spacing may be increased from 25 mm to 35 mm

b)  $x = 25$  mm for welded I-anchors

c)  $l_{min} = 150$  mm for welded I-anchors

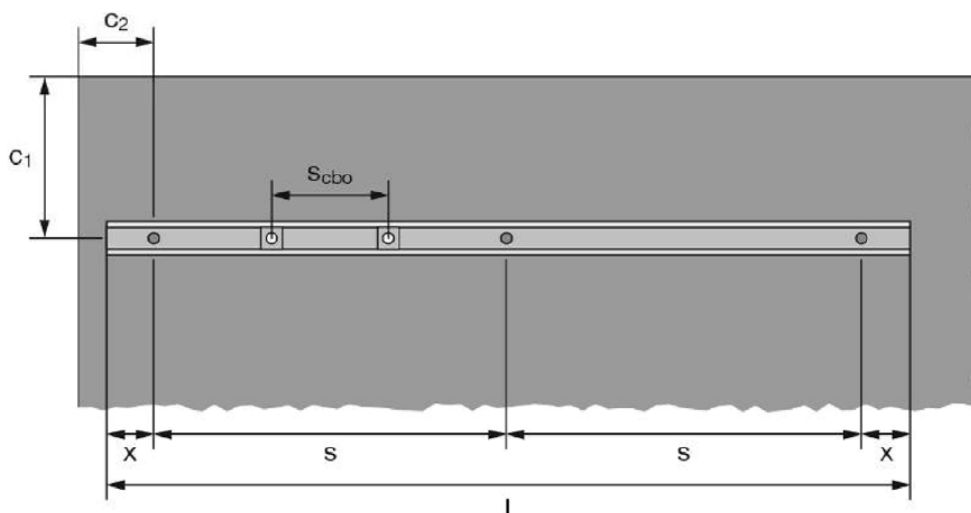

**Setting details for channel bolts**

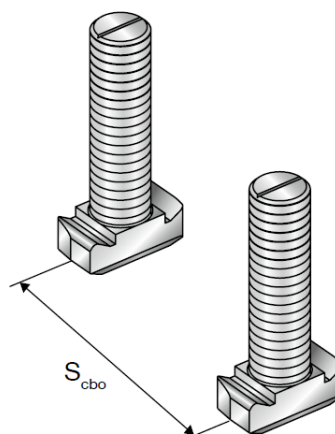
Anchor channel size		M10	M12	M16	M20
Minimum spacing between channel bolts	$s_{cbo,min}$ [mm]	50	60	80	100

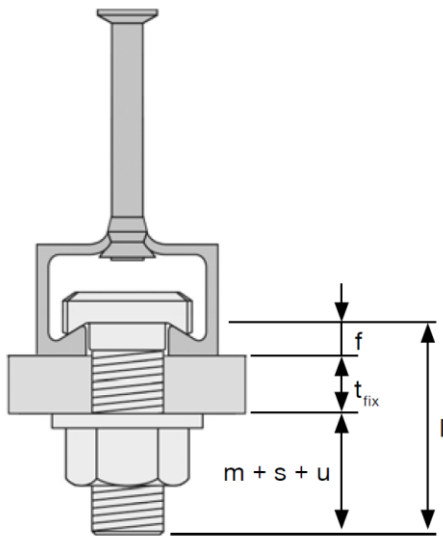

**Determination of the minimum required T-bolt length**

Anchor channel type		HAC-C				
		40/22		50/30		52/34
Anchor channel size		HBC 40/22	HBC 40/22-N	HBC 50/30	HBC 50/30-N	HBC 50/30
Channel bolt type		HBC 40/22	HBC 40/22-N	HBC 50/30	HBC 50/30-N	HBC 50/30
Height of channel lip	f [mm]	6,0	6,0	8,0	8,0	11,5
Thickness of nut, washer and channel bolt projection	Bolt M10	13,9	-	-	-	-
	Bolt M12	17,3	-	17,3	-	17,3
	Bolt M16	21,8	21,8	21,8	21,8	21,8
	Bolt M20	-	-	27,0	27,0	27,0

**Dimensions**

l	[mm]	nominal length of channel bolt
t <sub>fix</sub>	[mm]	fastenable thickness (thickness of the attached part)
f	[mm]	height of channel lip
m	[mm]	thickness of the nut (ISO 4032)
s	[mm]	thickness of the washer
u	[mm]	channel bolt projection

Required T-Bolt length :  $l = t_{fix} + f + (m + s + u)$

## Setting instructions

\*For detailed information on installation see instruction for use given with the package of the product

### Setting instruction for anchor channel

#### 1. Correct selection of anchor channel

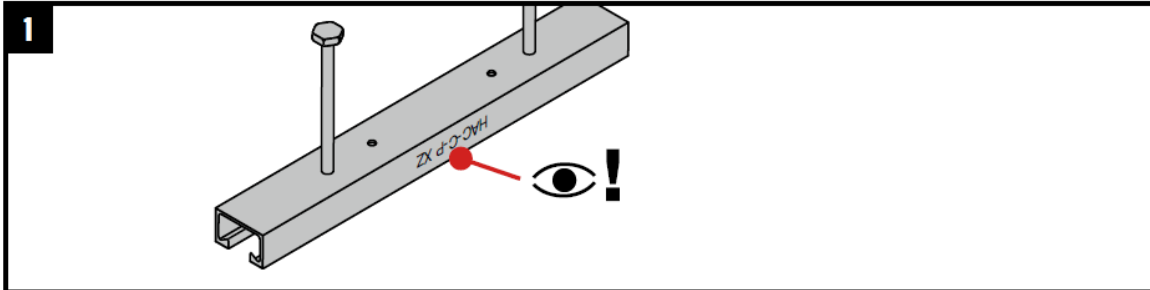

#### 2. Cut the anchor channel (if necessary) with required end spacing

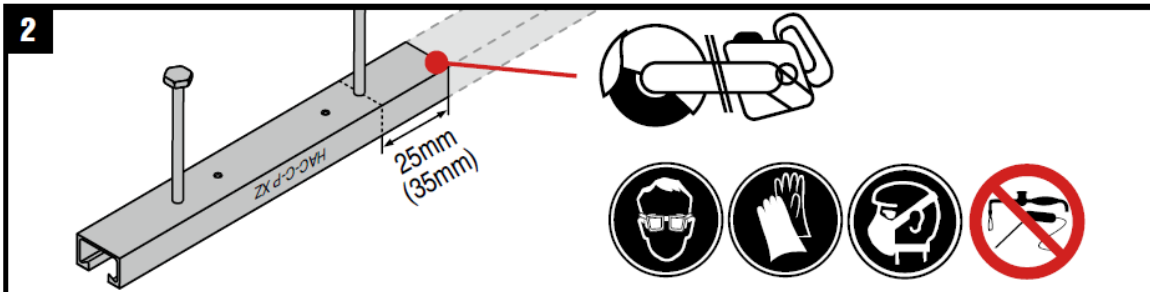

#### 3. Position of anchor channel flush with the surface

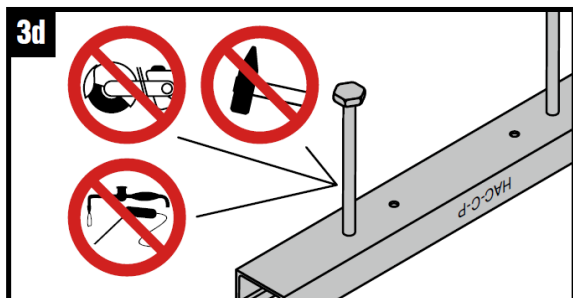
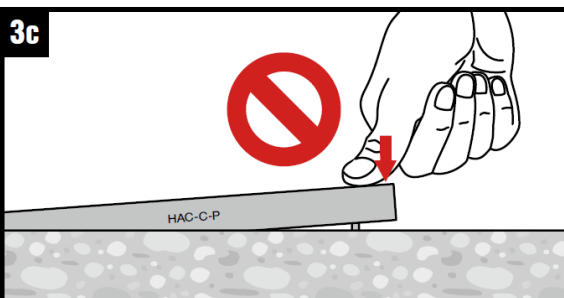
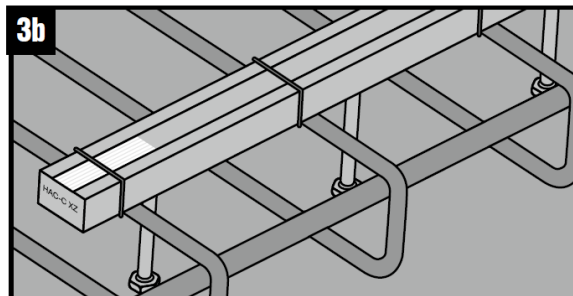
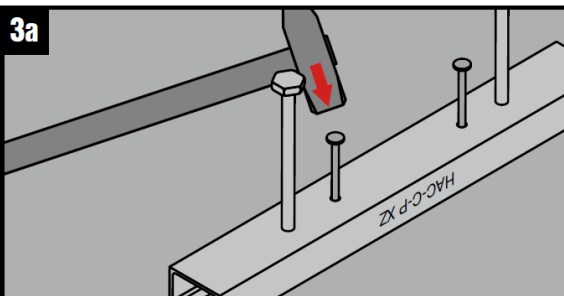

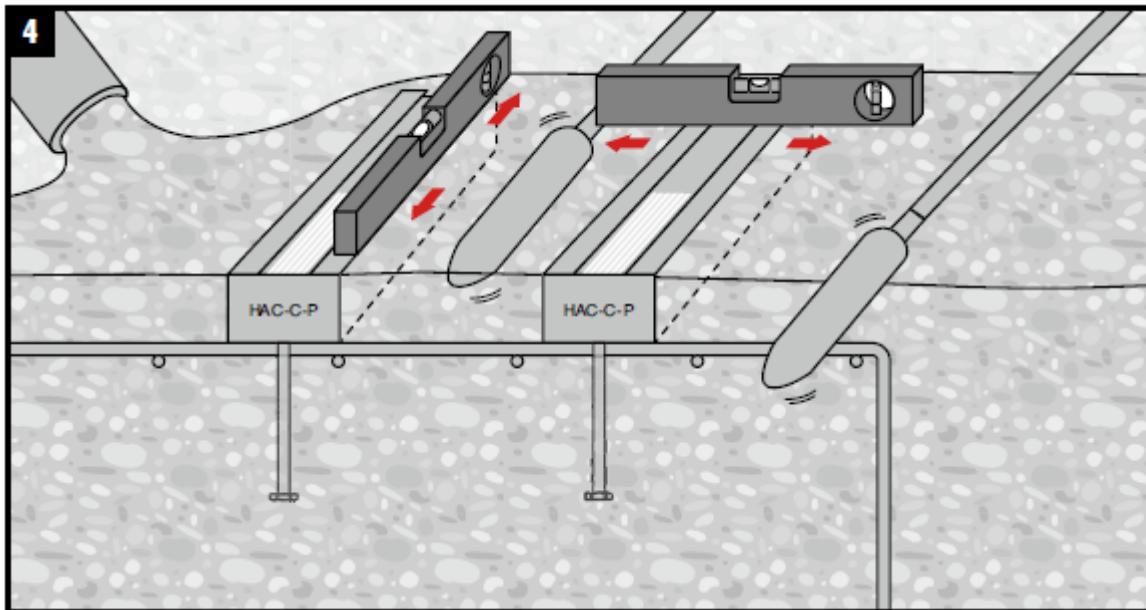
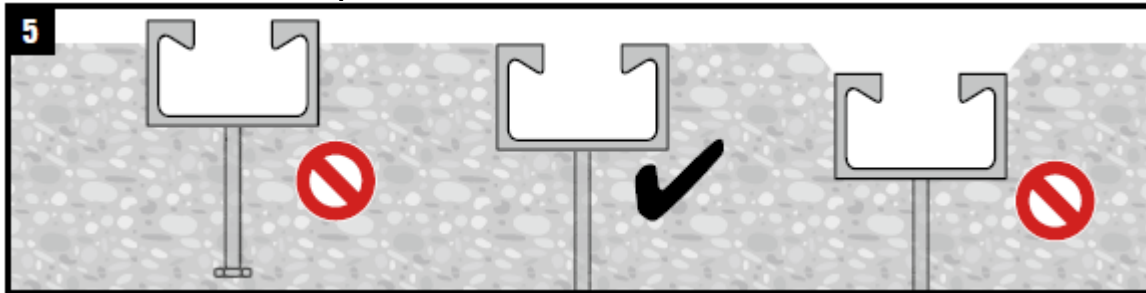
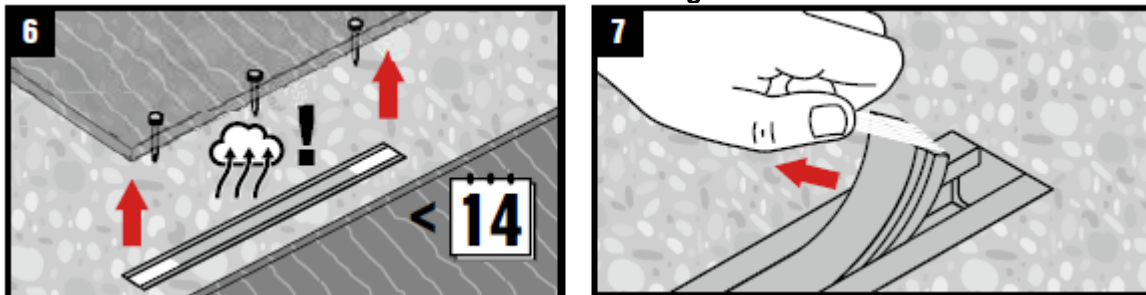
**4. Pouring the concrete****5. Check anchor channels position****6. Remove the formwork and foam filler after hardening of concrete**

\*For detailed information on installation see instruction for use given with the package of the product

### Setting instruction for channel bolts

#### 1. Correct selection of channel bolt

	HBC-28/15	HAC-C 28/15
	HBC-38/17	HAC-C 38/17
	HBC-40/22	HAC-C-P 40/22, HAC-C-P 40L, HAC-C 40/22, HAC-C 40/25
	HBC-50/30	HAC-C-P 50/30, HAC-C-P 50L, HAC-C 49/30, HAC-C 50/30
	HBC-52/34	HAC-C 52/34, HAC-C 54/33
	HBC-52/34	HAC-HW53, HAC-C 52/34

#### 2-5. Installation of the channel bolt

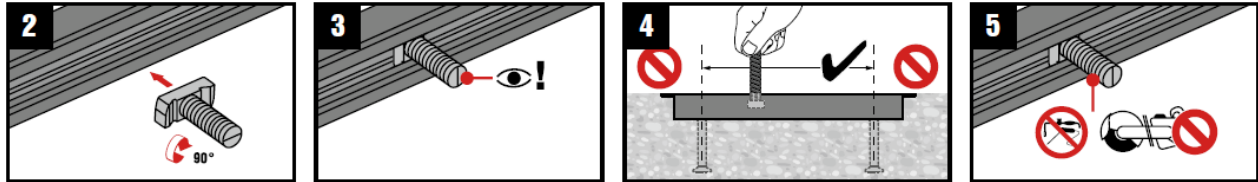

#### 6. Installation of the fixture

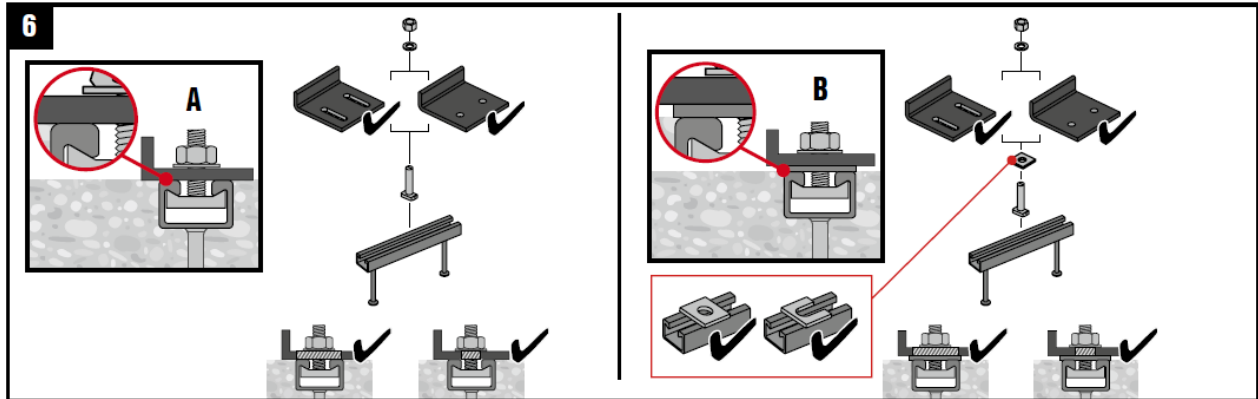

#### 7. Apply the installation torque $T_{inst}$

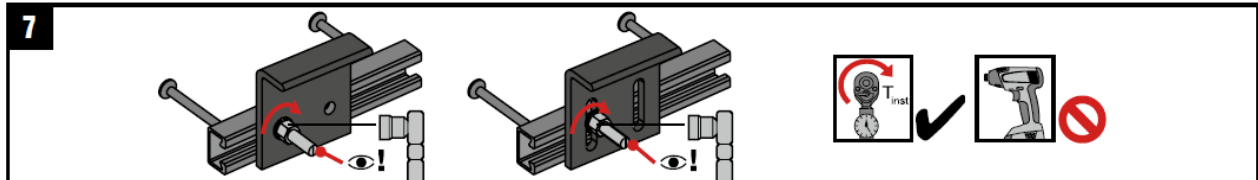



Channel bolt		$T_{inst}$ [Nm]				
		 4.6, 8.8, A4-50, A4-70	4.6	8.8	A4-50	A4-70
HBC-28/15	M8	7	-	20	7	15
	M10	10	-	40	-	30
	M12	13	-	60	-	50
HBC-38/17	M10	15	13	15	-	22
	M12	25	-	45	-	50
	M16	40	-	100	-	90
HBC-40/22	M10	15	13	15	-	22
	M12	25	-	45	-	50
	M16	30	-	100	-	90
HBC-50/30	M12	25	-	45	-	50
	M16	55	-	100	-	130
	M20	55	-	360	-	250
HBC-52/34	M20	55	-	360	-	-

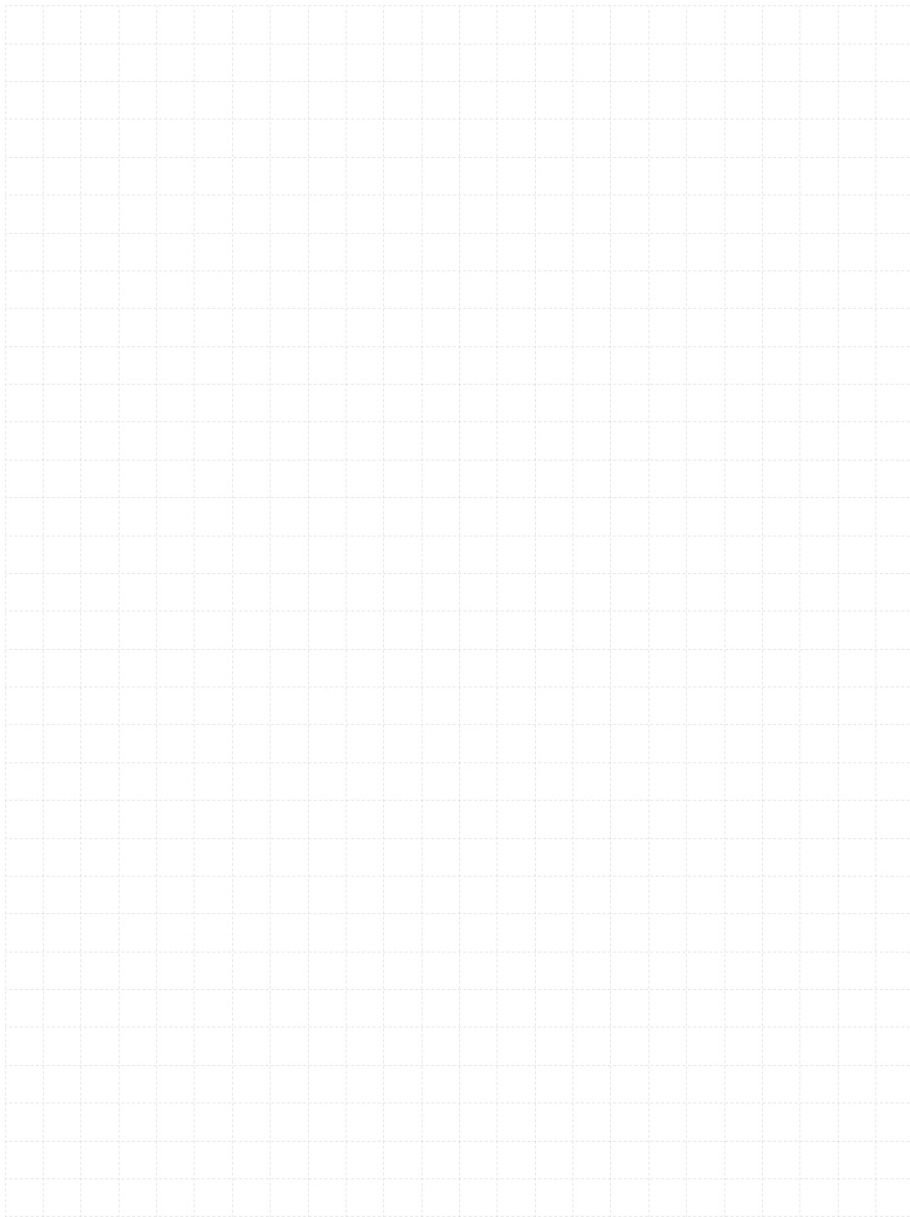
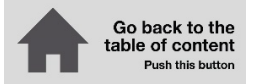





#### 4.1.2 HAC-C-P (hot rolled)





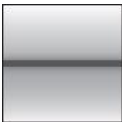
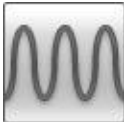

# HAC-C-P Hot rolled

Cast-in anchor channels with increased steel capacity for a variety of applications

Anchor channel version	Benefits
 <p>HAC-C-P 40/22 HAC-C-P 50/30</p>	<ul style="list-style-type: none"> <li>- New resilience - thanks to higher static tensile and shear load values, the same anchor channels can be specified for almost any load</li> <li>- Personal and software-based technical support - with the Hilti PROFIS Anchor Channel software and the Hilti engineering support team you can optimize your planning and construction</li> <li>- For even shorter assembly times - end caps with nail holes, ready-to-use filling foam and many other extras support faster and easier assembly of these anchor rails</li> </ul>
 <p>HAC-C-P 40L HAC-C-P 50L</p>	<ul style="list-style-type: none"> <li>- Available in stainless steel and hot-dip galvanized versions - for optimal corrosion protection depending on the environmental conditions</li> </ul>
	 <p>HBC-40/22 HBC-50/30</p>

Base material	Load conditions
 <p>Concrete (non-cracked)</p>  <p>Concrete (cracked)</p>	 <p>Static/ quasi-static</p>  <p>Fatigue</p>  <p>Fire resistance</p>  <p>Static 2D loading</p>  <p>Static 3D loading</p>

Other information			
 <p>European Technical Assessment</p>	 <p>CE conformity</p>	 <p>PROFIS Anchor channel design Software</p>	 <p>Corrosion resistance</p>

## Approvals / certificates

Description	Authority / Laboratory	No. / date of issue
European technical assessment <sup>a)</sup>	DIBt, Berlin	ETA-17/0336 of 09.11.2020

a) All data given in this section according to ETA-17/0336 of 09.11.2020

## Static and quasi-static loading

### All data in this section applies to:

- Correct setting (See setting instruction)
- No edge distance and spacing influence
- No influence of bolt type and diameter
- Decisive failure mode – local flexure of channel lips
- Shear load applied perpendicular to the longitudinal axis of the channel

### Effective anchorage depth

Anchor channel type		HAC-C-P			
Anchor channel size		40/22	40L	50/30	50L
Minimum effective anchorage depth	$h_{ef,min}$ [mm]	91	106	106	148
Minimum thickness of concrete member	$h_{min}$ [mm]	100	120	120	162

### Characteristic resistance

Anchor channel type		HAC-C-P			
Anchor channel size		40/22	40L <sup>a)</sup>	50/30	50L <sup>a)</sup>
Tension	$N^0_{Rk,s,l}$ [kN]	47,9		50,5	
Shear	$V^0_{Rk,s,l}$ [kN]	55,0		91,7	

a) HAC-C-P 40L and 50L have increased length of anchors. Therefore they have increased concrete resistance compared to standard HAC-C-P 40/22 and 50/30 which is not reflected in the table

### Design resistance

Anchor channel type		HAC-C-P			
Anchor channel size		40/22	40L <sup>a)</sup>	50/30	50L <sup>a)</sup>
Tension	$N^0_{Rd,s,l}$ [kN]	26,6		28,1	
Shear	$V^0_{Rd,s,l}$ [kN]	30,6		50,9	

a) HAC-C-P 40L and 50L have increased length of anchors. Therefore they have increased concrete resistance compared to standard HAC-C-P 40/22 and 50/30 which is not reflected in the table

**Note:** Values shown in table above are representing only limited amount of the possible failure modes and might be used only for comparison of different products. For detailed design of fixing point please use Hilti PROFIS Anchor Channel software, consult ETA-17/0336 or contact Hilti Engineering team.



**Characteristic resistance for bolts**

Channel bolt diameter				M8	M10	M12	M16	M20
<b>Channel bolt type</b>				<b>HBC-40/22</b>				
Tension	HBC-40/22 4.6	$N_{Rk,s}$	[kN]	- a)	23,2	- a)		
	HBC-40/22 8.8				- a)	67,4	125,6	- a)
	HBC-40/22 A4-70				20,5	59,0	91,0	
Shear	HBC-40/22 4.6	$V_{Rk,s}$	[kN]	- a)	13,9	- a)		
	HBC-40/22 8.8				23,2	33,7	62,8	- a)
	HBC-40/22 A4-70				24,4	35,4	65,9	
<b>Channel bolt type</b>				<b>HBC-50/30</b>				
Tension	HBC-50/30 4.6	$N_{Rk,s}$	[kN]	- a)	- a)			
	HBC-50/30 8.8				- a)	67,4	125,6	147,1
	HBC-50/30 A4-70				- a)	59,0	109,9	121,2
Shear	HBC-50/30 4.6	$V_{Rk,s}$	[kN]	- a)	- a)			
	HBC-50/30 8.8				- a)	33,7	62,8	101,7
	HBC-50/30 A4-70				- a)	35,4	65,9	102,9
<b>Channel bolt type</b>				<b>HBC-50/30-N</b>				
Tension	HBC-50/30-N	$N_{Rd,s}$	[kN]				125,6	186,6
Shear	HBC-50/30-N	$V_{Rd,s}$	[kN]				62,8	101,7

a) Product is not available in standard Hilti portfolio. For additional information please contact Hilti Engineering team.

**Design resistance for bolts**

Channel bolt diameter				M8	M10	M12	M16	M20
<b>Channel bolt type</b>				<b>HBC-40/22</b>				
Tension	HBC-40/22 4.6	$N_{Rd,s}$	[kN]	- a)	11,6	- a)		
	HBC-40/22 8.8				- a)	44,9	83,7	- a)
	HBC-40/22 A4-70				11,0	31,6	48,7	
Shear	HBC-40/22 4.6	$V_{Rd,s}$	[kN]	- a)	8,3	- a)		
	HBC-40/22 8.8				18,6	27,0	50,2	- a)
	HBC-40/22 A4-70				15,6	22,7	42,2	
<b>Channel bolt type</b>				<b>HBC-50/30</b>				
Tension	HBC-50/30 4.6	$N_{Rd,s}$	[kN]	- a)	- a)			
	HBC-50/30 8.8				- a)	44,9	84,5	98,1
	HBC-50/30 A4-70				- a)	31,6	58,8	64,8
Shear	HBC-50/30 4.6	$V_{Rd,s}$	[kN]	- a)	- a)			
	HBC-50/30 8.8				- a)	27,0	50,2	81,4
	HBC-50/30 A4-70				- a)	22,7	42,4	66,0
<b>Channel bolt type</b>				<b>HBC-50/30-N</b>				
Tension	HBC-50/30-N	$N_{Rd,s}$	[kN]		- a)		83,7	124,4
Shear	HBC-50/30-N	$V_{Rd,s}$	[kN]		- a)		50,2	81,4

b) Product is not available in standard Hilti portfolio. For additional information please contact Hilti Engineering team.

**Note:** combined effects of loads (tension and shear) must be verified additionally. For detailed design of fixing point please use Hilti PROFIS Anchor Channel software, consult ETA-17/0336 or contact Hilti Engineering team.

## Fire resistance

### All data in this section applies to:

- Correct setting (See setting instruction)
- No edge distance and spacing influence
- No influence of bolt type and diameter
- Decisive failure mode – steel failure  
(one of the following: anchor, connection between anchor and channel, local flexure of channel lip)
- Shear load applied perpendicular to the longitudinal axis of the channel
- Partial safety factor for resistance under fire exposure  $\gamma_{M,fi}=1,0$  (in absence of other national regulations)

### Effective anchorage depth

Anchor channel type			HAC-C-P			
Anchor channel size			40/22	40L	50/30	50L
Minimum effective anchorage depth	$h_{ef,min}$	[mm]	91	106	106	148
Minimum thickness of concrete member	$h_{min}$	[mm]	100	120	120	162

### Characteristic resistance

Anchor channel type			HAC-C-P			
Anchor channel size			40/22	40L	50/30	50L
<b>Fire exposure R60</b>						
Tension	Bolt M10	$N_{Rk,s,fi}$	1,7		-	
=	Bolt M12	=	3,5		3,8	
Shear	Bolt $\geq$ M16	$V_{Rk,s,fi}$	3,5		3,9	
<b>Fire exposure R120</b>						
Tension	Bolt M10	$N_{Rk,s,fi}$	0,9		-	
=	Bolt M12	=	1,5		1,9	
Shear	Bolt $\geq$ M16	$V_{Rk,s,fi}$	1,5		2,4	

### Design resistance

Anchor channel type			HAC-C-P			
Anchor channel size			40/22	40L	50/30	50L
<b>Fire exposure R60</b>						
Tension	Bolt M10	$N_{Rd,s,fi}$	1,7		-	
=	Bolt M12	=	3,5		3,8	
Shear	Bolt $\geq$ M16	$V_{Rd,s,fi}$	3,5		3,9	
<b>Fire exposure R120</b>						
Tension	Bolt M10	$N_{Rd,s,fi}$	0,9		-	
=	Bolt M12	=	1,5		1,9	
Shear	Bolt $\geq$ M16	$V_{Rd,s,fi}$	1,5		2,4	

**Note:** Values shown in table above are representing only limited amount of the possible failure modes and might be used only for comparison of different products. For detailed design of fixing point please use Hilti PROFIS Anchor Channel software, consult ETA-17/0336 or contact Hilti Engineering team.

**Minimum axis distance of reinforcement**

Anchor channel type		HAC-C-P			
		40/22	40L	50/30	50L
<b>Fire exposure R60</b>					
Minimum axis distance	a [mm]	35		50	
<b>Fire exposure R120</b>					
Minimum axis distance	a [mm]	55		55	

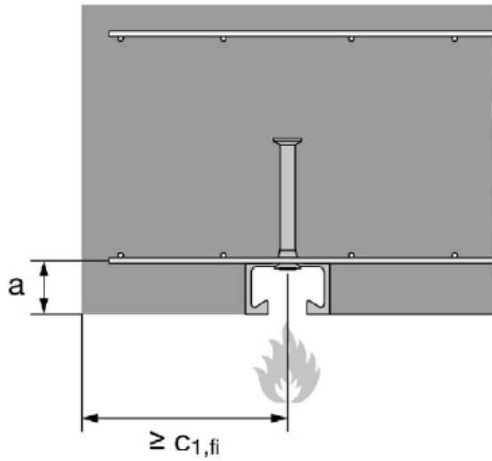
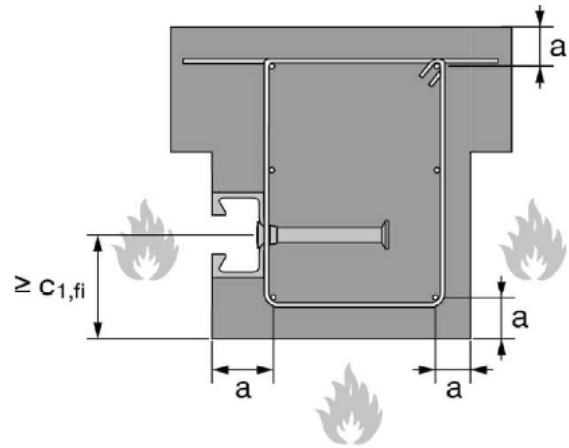
**Fire exposure from one side only**

**Fire exposure from more than one side**

## Fatigue resistance

### All data in this section applies to:

- Correct setting (See setting instruction)
- No edge distance and spacing influence
- No influence of bolt type and diameter
- Shear load applied perpendicular to the longitudinal axis of the channel

### Characteristic resistance under fatigue load

Anchor channel type		HAC-C-P			
Anchor channel size		40/22	40L	50/30	50L
Characteristic resistance under fatigue tension load after n load cycles without static preload ( $N_{Ed} = 0$ )	$\leq 10^4$	$\Delta N_{Rk,s,0,n}$ [kN]	16,5	20,9	
	$\leq 10^5$				
	$\leq 10^6$				
	$\leq 2 \cdot 10^6$				
	$\leq 5 \cdot 10^6$				
	$\leq 10^8$				
	$> 10^8$				
Reduction factor after n load cycles without static preload ( $N_{Ed} = 0$ ) for: $\Delta N_{Rk,p,0,n} = \eta_{c,fat} \cdot N_{Rk,p}$ $\Delta N_{Rk,c,0,n} = \eta_{c,fat} \cdot N_{Rk,c}$	$\leq 10^4$	$\eta_{c,fat}$ [-]	0,736	0,665	
	$\leq 10^5$				
	$\leq 10^6$				
	$\leq 2 \cdot 10^6$				
	$\leq 5 \cdot 10^6$				
	$\leq 6 \cdot 10^7$				
	$> 10^7$				
Characteristic fatigue limit resistance without static preload ( $N_{Ed} = 0$ )	$(n \rightarrow \infty)$	$\Delta N_{Rk,s,0,\infty}$ [kN]	1,8	3,2	
Reduction factor for fatigue limit resistance without static preload ( $N_{Ed} = 0$ ) for: $\Delta N_{Rk,p,0,n} = \eta_{c,fat} \cdot N_{Rk,p}$ $\Delta N_{Rk,c,0,n} = \eta_{c,fat} \cdot N_{Rk,c}$	$(n \rightarrow \infty)$	$\eta_{c,fat}$ [-]	0,500		

**Note:** Values shown in table above are representing only limited amount of the possible failure modes and might be used only for comparison of different products. For detailed design of fixing point please use Hilti PROFIS Anchor Channel software, consult ETA-17/0336 or contact Hilti Engineering team.

## Materials

### Material quality for anchor channels

Part		Material
Channel profile	HAC-C	Carbon steel 1.0038, 1.0044, 1.0045 according to EN 10025:2005 Carbon steel 1.0976, 1.0979 according to EN 10139:2013 Hot-dip galvanized $\geq 50 \mu\text{m}$ according to EN ISO 10684:2004/AC:2009
	HAC-C A4	Stainless steel 1.4362, 1.4401, 1.4404, 1.4571, 1.4578 according to EN 10088:2005
Anchor	HAC-C	Carbon steel 1.0038, 1.0213, 1.0214 according to EN 10025:2005 Carbon steel 1.5523, 1.5535 according to EN 10263:2002-02 Hot-dip galvanized $\geq 50 \mu\text{m}$ according to EN ISO 10684:2004/AC:2009
	HAC-C A4 <sup>a)</sup>	Stainless steel 1.4362, 1.4401, 1.4404, 1.4571, 1.4578 according to EN 10088:2005

a) Anchors made of carbon steel may also be used if they are welded and their concrete cover is more than 50 mm and the tempering colors are removed

### Material quality for channel bolts

Part		Material
Channel bolts	HBC	Carbon steel grade 4.6 and 8.8 according to ISO 898-1:2013 Electroplated according to EN ISO 4042:1999
	HBC F	Carbon steel grade 4.6 and 8.8 according to ISO 898-1:2013 Hot-dip galvanized $\geq 50 \mu\text{m}$ according to EN ISO 10684:2004/AC:2009
	HBC A4	Stainless steel grade 50 or 70 according to EN ISO 3506:2009
Plain washer	Galvanized	Carbon steel, hardness class A $\geq 200 \text{ HV}$ Electroplated according to EN ISO 4042:1999
	F	Carbon steel, hardness class A $\geq 200 \text{ HV}$ Hot-dip galvanized $\geq 50 \mu\text{m}$ according to EN ISO 10684:2004/AC:2009
	A4	Stainless steel 1.4401, 1.4404, 1.4571, 1.4578 according to EN 10088:2005
Hexagonal nut <sup>a)</sup>	Galvanized	Property class 5 or 8 according to EN ISO 898-2:2012 Electroplated according to EN ISO 4042:1999
	F	Property class 5 or 8 according to EN ISO 898-2:2012 Hot-dip galvanized $\geq 50 \mu\text{m}$ according to EN ISO 10684:2004/AC:2009
	A4	Property class 50, 70 or 80 according to EN ISO 3506:2009

a) Hexagonal nuts according to DIN 934: 1987-10 for channel bolts made from carbon steel (4.6) and stainless steel

### Mechanical properties

Part		HAC-C / HBC		
Nominal tensile strength	Carbon steel 4.6	$f_{uk}$	[N/mm <sup>2</sup> ]	
	Carbon steel 8.8			400
	Stainless steel A4-50			800 / 830 <sup>a)</sup>
	Stainless steel A4-70			500
Yield strength	Carbon steel 4.6	$f_{yk}$	[N/mm <sup>2</sup> ]	
	Carbon steel 8.8			240
	Stainless steel A4-50			640 / 660 <sup>a)</sup>
	Stainless steel A4-70			210
				450

a) Material properties according to EN ISO 898-1

**Corrosion class**

Class / Mark	Material / Coating type
G	Carbon steel, electroplated
F (HDG)	Carbon steel, hot-dip galvanized
R (A4)	Stainless steel

**Nomenclature of HAC-C-P anchor channels (example)**

Hilti anchor channel type	Profile type and size	Channel length	Finish or material
①	②	③	④
HAC-C-P	40/22	300	F (HDG)
HAC-C-P	40L	300	F (HDG)

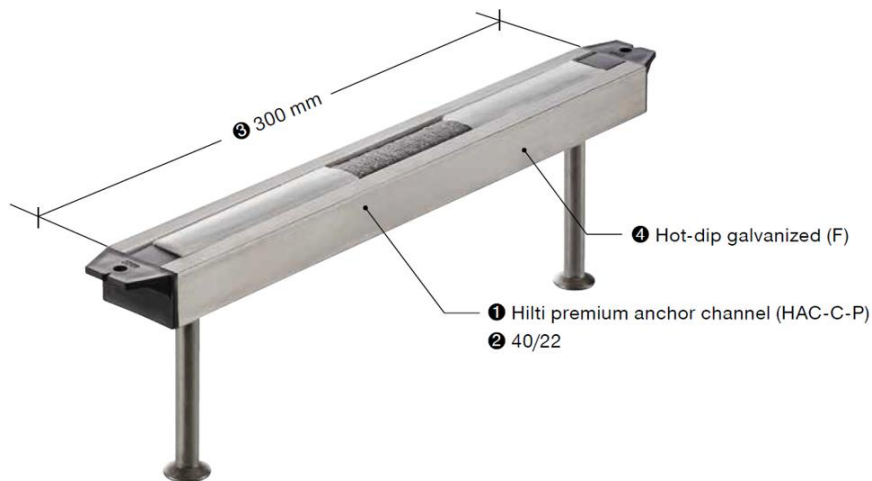
**HAC-C-P 40/22 300F**

**HAC-C-P 40L 300F**

**Nomenclature of HBC channel bolts (example)**

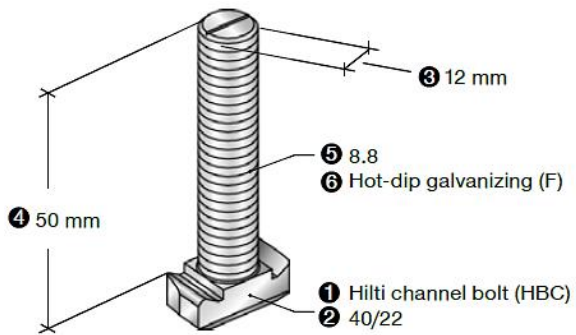
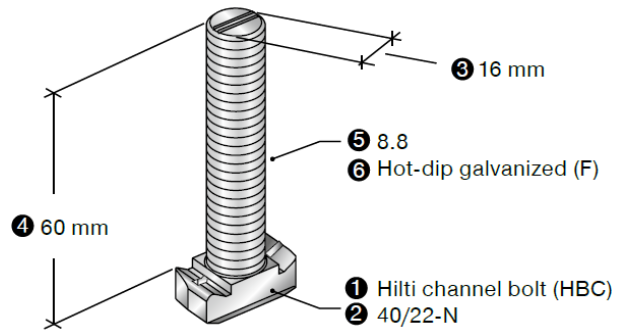
Hilti channel bolt	Bolt type	Diameter	Bolt length	Steel grade	Finish or material
①	②	③	④	⑤	⑥
HBC	40/22	M12	50	8.8	F (HDG)
HBC	40/22-N	M16	60	8.8	F (HDG)

**HBC-40/22 M12x50 8.8 F**  
 (standard bolt)

**HBC-40/22 M16x60 8.8F**  
 (notched bolt)

## Dimensions of anchor channels

### Dimensions of channel profile

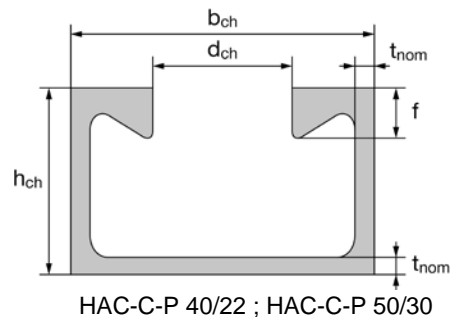
Anchor channel type		HAC-C-P			
		40/22	40L	50/30	50L
Channel width	$b_{ch}$ [mm]	40,1		49,6	
Channel height	$h_{ch}$ [mm]	23,0		30,0	
Nominal thickness	$t_{nom}$ [mm]	2,7		3,2	
Width of channel opening	$d_{ch}$ [mm]	18,0		22,5	
Height of channel lips	$f$ [mm]	6,0		8,1	
Moment of inertia	$I_y$ [mm <sup>4</sup> ]	21504		57781	



### Dimensions of anchors

Anchor channel type		HAC-C-P			
		40/22	40L	50/30	50L
<b>Version with welded I-anchor</b>					
Minimum anchor length	min. $l_a$ [mm]	125,0	- a)	125,0	- a)
Web thickness	$t_w$ [mm]	6,0	- a)	6,0	- a)
Width of the head	$b_h$ [mm]	25,0	- a)	25,0	- a)
Head thickness	$t_h$ [mm]	5,0	- a)	5,0	- a)
Width (cutting length)	$w_A$ [mm]	20,0	- a)	25,0	- a)
Area of the head	$A_h$ [mm]	380	- a)	475	- a)
<b>Version with round anchor</b>					
Minimum anchor length	min. $l_a$ [mm]	70,0	83,2	78,0	118,3
Diameter of anchor	$d_a$ [mm]	10,0	10,0	11,0	11,0
Diameter of round anchor head	$d_h$ [mm]	21,5	21,5	26,0	26,0
Thickness of round anchor head	$t_h$ [mm]	2,2	2,2	2,5	2,6
Area of round anchor head	$A_h$ [mm]	285	285	436	436

a) Product is not available

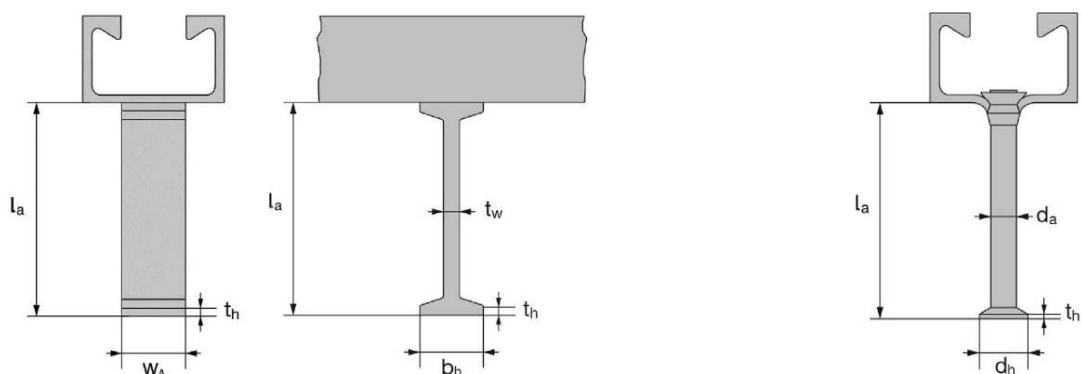

Version with welded I-Anchor

Version with round anchor



## Dimensions of channel bolts

### Dimensions of channel bolts

Channel bolt type			HBC-40/22			HBC-40/22-N
Appropriate anchor channel			HAC-C-P 40/22; HAC-C-P 40L			
Nominal diameter	d	[mm]	10,0	12,0	16,0	16,0
Width (1)	b <sub>1</sub>	[mm]	14,0	14,0	17,0	17,0
Width (2)	b <sub>2</sub>	[mm]	33,0	33,0	33,0	33,0
Thickness	k	[mm]	10,5	11,5	11,5	11,5

### Dimensions of channel bolts

Channel bolt type			HBC-50/30			HBC-50/30-N	
Appropriate anchor channel			HAC-C-P 50/30; HAC-C-P 50L				
Nominal diameter	d	[mm]	12,0	16,0	20,0	16,0	20,0
Width (1)	b <sub>1</sub>	[mm]	17,0	17,0	21,0	21,0	21,0
Width (2)	b <sub>2</sub>	[mm]	42,0	42,0	42,0	42,0	42,0
Thickness	k	[mm]	14,5	15,5	15,5	15,5	15,5

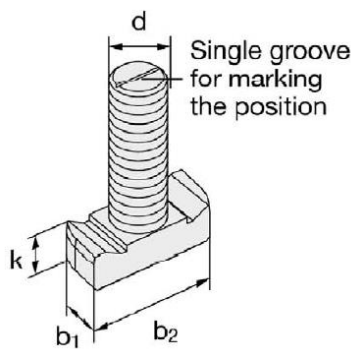

HBC-40/22, HBC-50/30

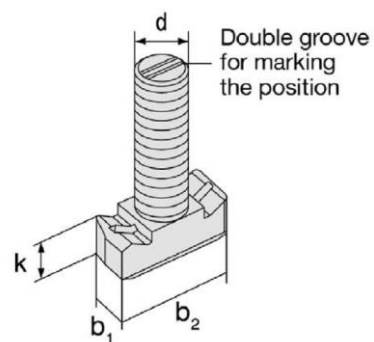

HBC-40/22-N, HBC-50/30-N

**Setting information**
**Setting details for anchor channels**

Anchor channel type			HAC-C-P			
			40/22	40L	50/30	50L
Minimum effective embedment depth	$h_{ef,min}$	[mm]	91	106	106	148
Nominal embedment depth	$h_{nom}$	[mm]	93,2	108,2	108,5	150,5
Minimum spacing	$s_{min}$	[mm]	50		50 <sup>a)</sup>	50
Maximum spacing	$s_{max}$	[mm]	250			
End spacing	x	[mm]	25 <sup>b)</sup>			
Minimum channel length	$l_{min}$	[mm]	100			
Minimum edge distance	$c_{min}$	[mm]	50		75	
Minimum thickness of concrete member	$h_{min}$	[mm]	100	120	120	162

- a)  $s_{min} = 100$  mm when used in combination with notched bolts  
 b) The end spacing may be increased from 25 mm to 35 mm  
 c) X = 25 mm for welded I-anchors

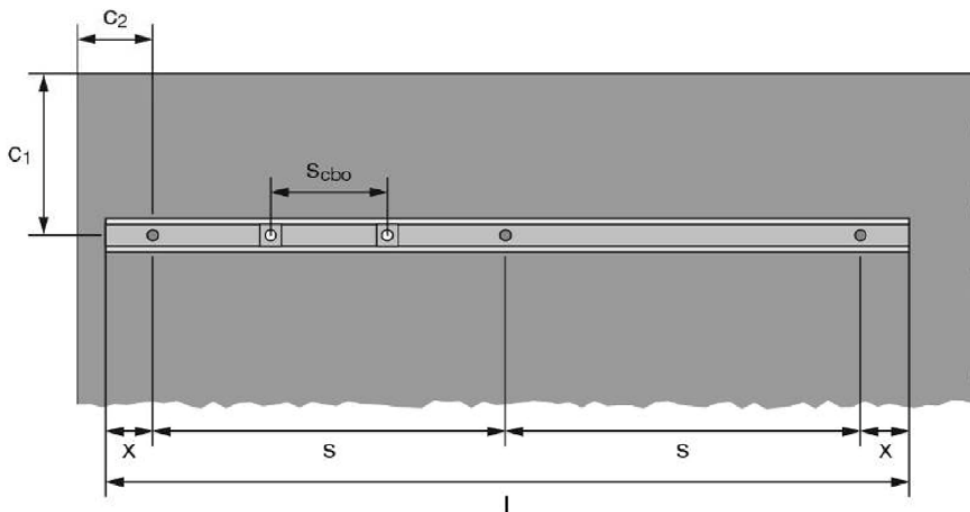

**Setting details for channel bolts**

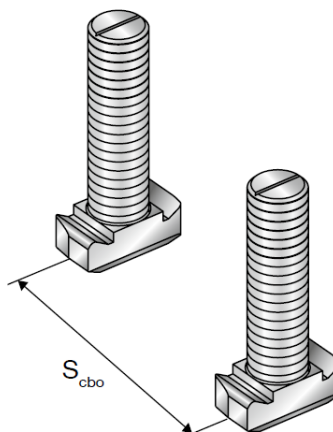
Anchor channel size		M10	M12	M16	M20	
Minimum spacing between channel bolts	$s_{cbo,min}$	[mm]	50	60	80	100

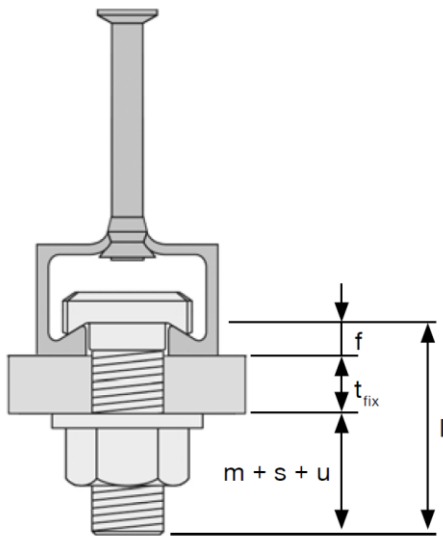

**Determination of the minimum required T-bolt length**

Anchor channel type		HAC-C-P			
		40/22; 40L		50/30; 50L	
Anchor channel size		HBC 40/22	HBC 40/22-N	HBC 50/30	HBC 50/30-N
Channel bolt type					
Height of channel lip	f [mm]	6,0	6,0	8,0	8,0
Thickness of nut, washer and channel bolt projection	Bolt M10	13,9	-	-	-
	Bolt M12	17,3	-	17,3	-
	Bolt M16	21,8	21,8	21,8	21,8
	Bolt M20	-	-	27,0	27,0

**Dimensions**

l	[mm]	nominal length of channel bolt
t <sub>fix</sub>	[mm]	fastenable thickness (thickness of the attached part)
f	[mm]	height of channel lip
m	[mm]	thickness of the nut (ISO 4032)
s	[mm]	thickness of the washer
u	[mm]	channel bolt projection

Required T-Bolt length :  $l = t_{fix} + f + (m + s + u)$

## Setting instructions

\*For detailed information on installation see instruction for use given with the package of the product

### Setting instruction for anchor channel

#### 1. Correct selection of anchor channel

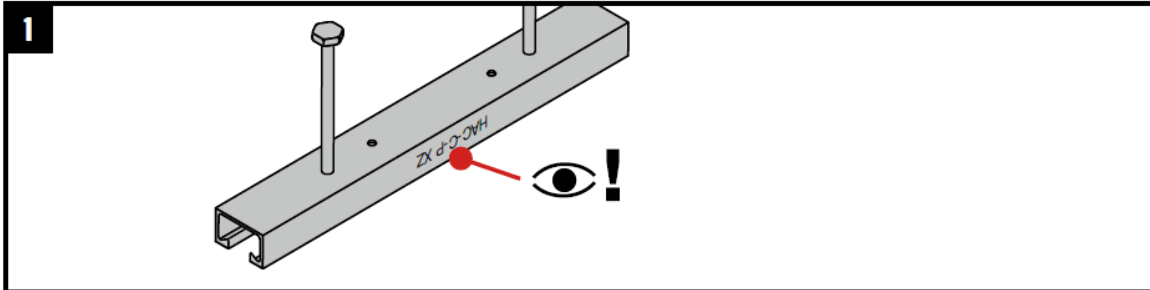

#### 2. Cut the anchor channel (if necessary) with required end spacing

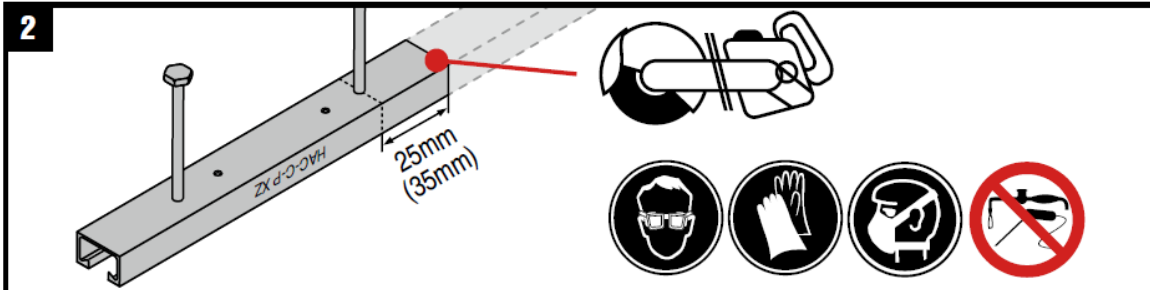

#### 3. Position of anchor channel flush with the surface

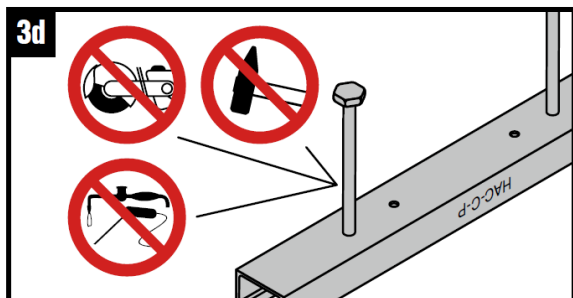
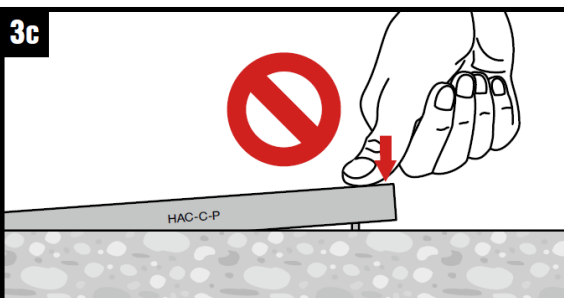
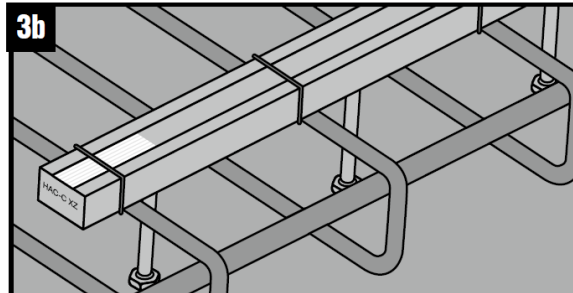
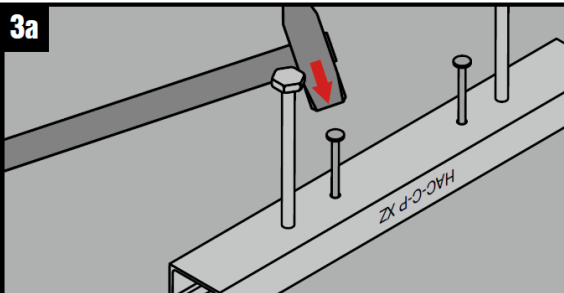

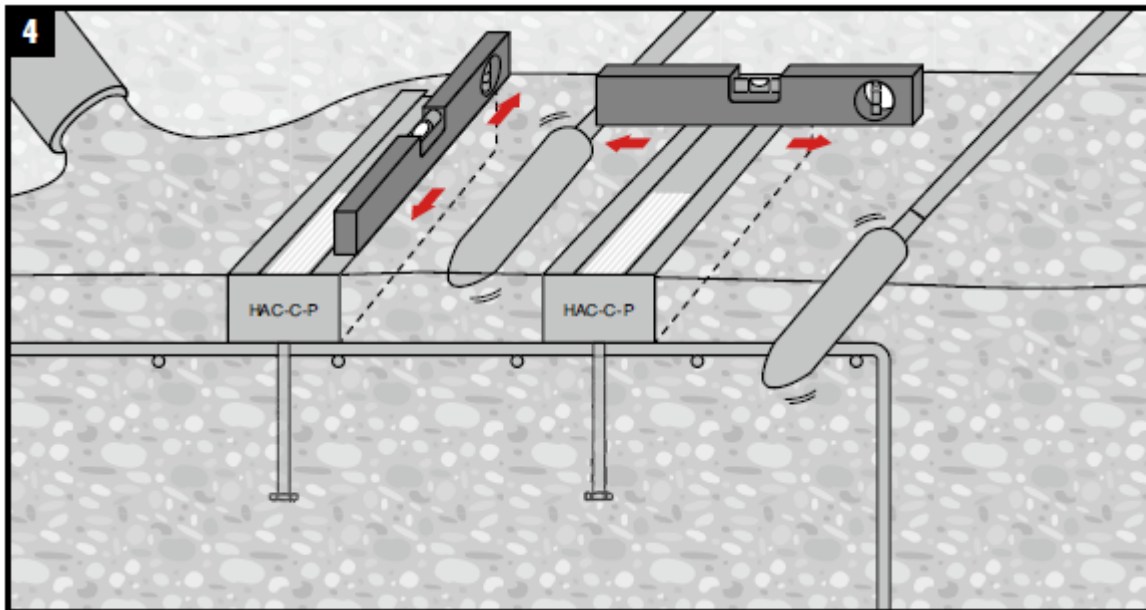
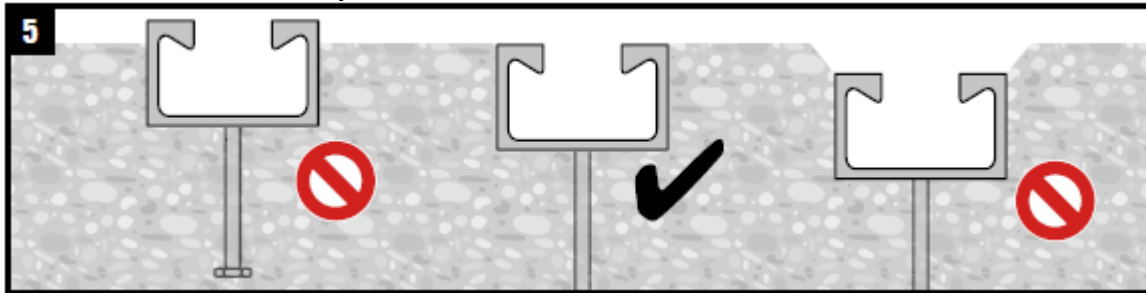
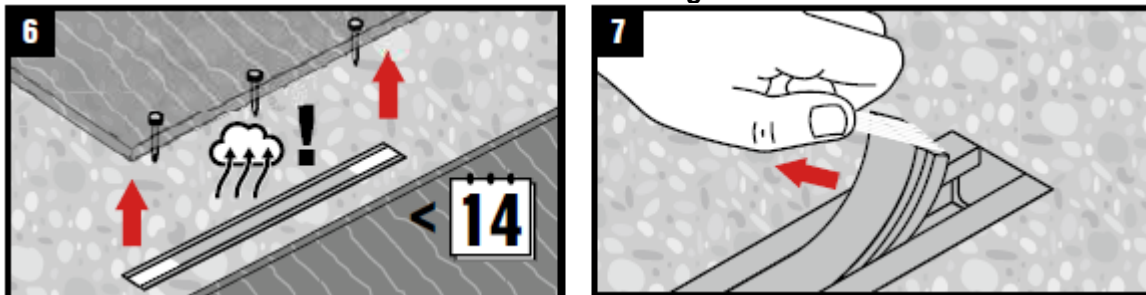
**4. Pouring the concrete****5. Check anchor channels position****6. Remove the formwork and foam filler after hardening of concrete**

\*For detailed information on installation see instruction for use given with the package of the product

### Setting instruction for channel bolts

#### 1. Correct selection of channel bolt

	HBC-28/15	HAC-C 28/15
	HBC-38/17	HAC-C 38/17
	HBC-40/22	HAC-C-P 40/22, HAC-C-P 40L, HAC-C 40/22, HAC-C 40/25
	HBC-50/30	HAC-C-P 50/30, HAC-C-P 50L, HAC-C 49/30, HAC-C 50/30
	HBC-52/34	HAC-C 52/34, HAC-C 54/33
	HBC-52/34	HAC-HW53, HAC-C 52/34

#### 2-5. Installation of the channel bolt

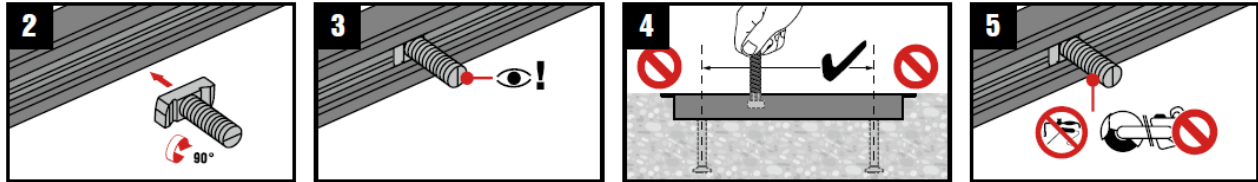

#### 6. Installation of the fixture

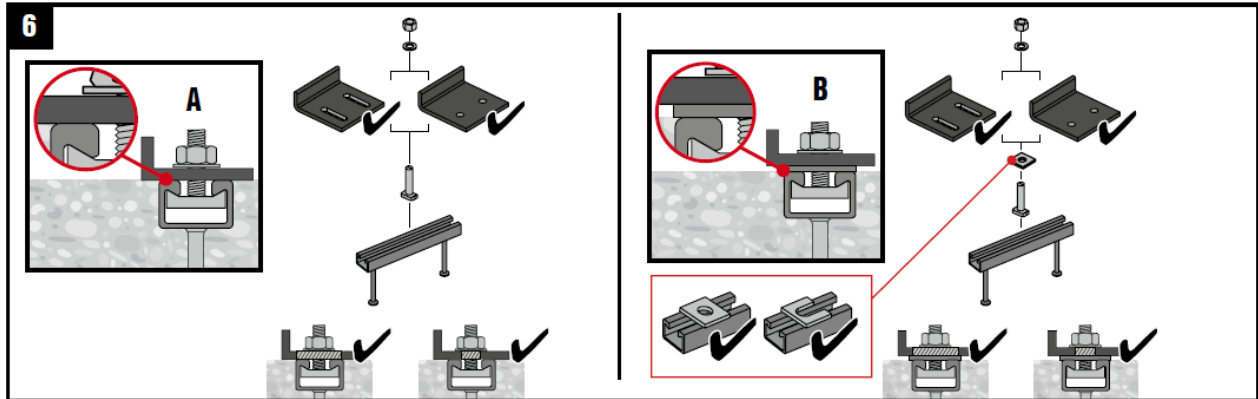

#### 7. Apply the installation torque $T_{inst}$

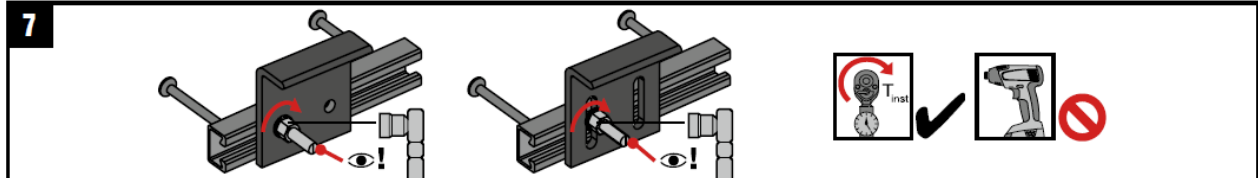

Channel bolt		$T_{inst}$ [Nm]				
		4.6, 8.8, A4-50, A4-70	4.6	8.8	A4-50	A4-70
HBC-28/15	M8	7	-	20	7	15
	M10	10	-	40	-	30
	M12	13	-	60	-	50
HBC-38/17	M10	15	13	15	-	22
	M12	25	-	45	-	50
	M16	40	-	100	-	90
HBC-40/22	M10	15	13	15	-	22
	M12	25	-	45	-	50
	M16	30	-	100	-	90
HBC-50/30	M12	25	-	45	-	50
	M16	55	-	100	-	130
	M20	55	-	360	-	250
HBC-52/34	M20	55	-	360	-	-

### 4.1.3 HAC-V

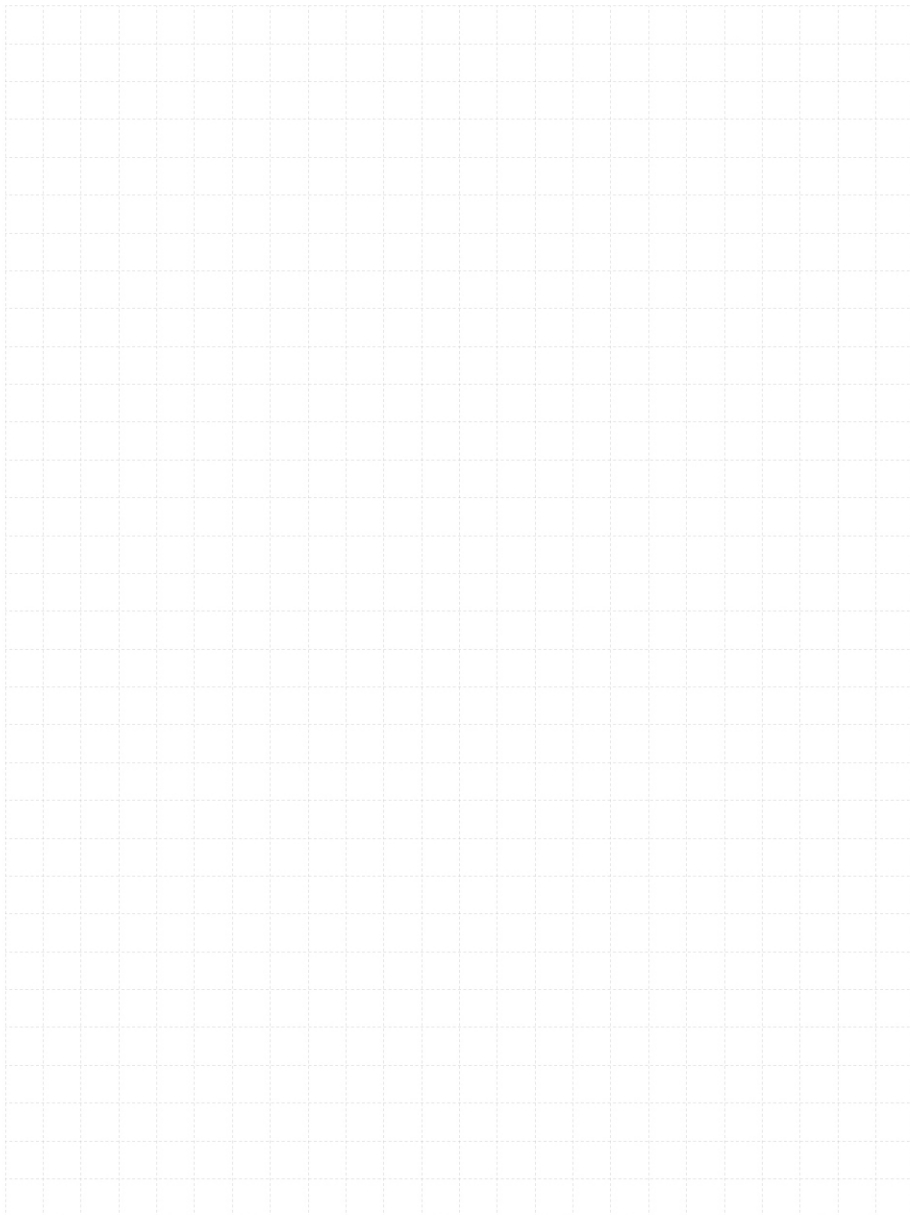







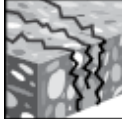
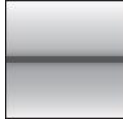
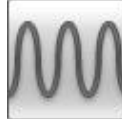

# HAC-V TCRS

Cast-in anchor channels in standard sizes and lengths for everyday applications

Anchor channel version	Benefits
	HBC-C HBC-C-E HBC-C-N HBC-T HBC-B
	HAC-V 35 HAC-V 40 HAC-V 50 HAC-V 60 HAC-V 70
	HAC-V-T 30 HAC-V-T 50 HAC-V-T 70

- Heavy-duty solution - designed for high loads and design parameters;
- Approved for static, seismic (ICC-ESR 3520), fatigue and fire loads;
- Customizable - options available for almost any specification;
- Production with low energy consumption - anchor channels can contribute to the environmental certification of construction projects;
- High-precision manufacturing

Base material	Load conditions
 <p>Concrete (non-cracked)</p>	 <p>Concrete (cracked)</p>
 <p>Static/ quasi-static</p>	 <p>Fatigue</p>
	 <p>Seismic</p>
	 <p>Fire resistance</p>
	 <p>Static 2D loading</p>
	 <p>Static 3D loading</p>

Other information			
 <p>European Technical Assessment</p>	 <p>CE conformity</p>	 <p>PROFIS Anchor channel design Software</p>	 <p>Corrosion resistance</p>

## Approvals / certificates

Description	Authority / Laboratory	No. / date of issue
European technical assessment <sup>a)</sup>	DIBt, Berlin	ETA-11/0006 of 24.10.2022

a) All data given in this section according to ETA-11/0006 of 24.10.2022



## Static and quasi-static loading

### All data in this section applies to:

- Correct setting (See setting instruction)
- No edge distance and spacing influence
- No influence of bolt type and diameter
- Decisive failure mode – local flexure of channel lips
- Shear load applied perpendicular to the longitudinal axis of the channel

### Effective anchorage depth

Anchor channel type			HAC-V					HAC-V-T		
Anchor channel size			35	40	50	60	70	30	50	70
Minimum effective anchorage depth <sup>a)</sup>	$h_{ef,min}$	[mm]	91	91	71	148	175	68	71	175
Minimum thickness of concrete member <sup>a) b)</sup>	$h_{min}$	[mm]	105	105	90	168	196	80	90	196

a) HAC-V 50, 60, 70 and HAC-V-T 50, 70 are produced with different length of anchors and as well available with increased embedment depth, which will lead to increased concrete cone capacity. Additional information is presented in Setting details;

b) Minimum thickness of concrete member depends on the minimum edge distance. Additional information is presented in Setting details

### Characteristic resistance

Anchor channel type			HAC-V					HAC-V-T		
Anchor channel size			35	40	50	60	70	30	50	70
Tension	$N_{Rk,s,l}^0$	[kN]	31,4	31,4	41,0	55,0	71,0	19,9	41,0	71,0
Shear	$V_{Rk,s,l}^0$	[kN]	37,4	37,4	55,0	82,9	102,9	27,7	60,5	118,8

### Design resistance

Anchor channel type			HAC-V					HAC-V-T		
Anchor channel size			35	40	50	60	70	30	50	70
Tension	$N_{Rd,s,l}^0$	[kN]	17,4	17,4	22,8	30,6	39,4	11,1	22,8	39,4
Shear	$V_{Rd,s,l}^0$	[kN]	20,8	20,8	30,6	46,1	57,2	15,4	33,6	66,0

**Note:** Values shown in table above are representing only limited amount of the possible failure modes and might be used only for comparison of different products. For detailed design of fixing point please use Hilti PROFIS Anchor Channel software, consult ETA-11/0006 or contact Hilti Engineering team.

**Characteristic resistance for bolts**

Channel bolt diameter				M10	M12	M16	M20
<b>Channel bolt type</b>				<b>HBC-B</b>			
Tension	HBC-B 4.6	$N_{Rk,s}$	[kN]	23,2	33,7	- a)	- a)
	HBC-B A4-50			29,0	42,2	- a)	- a)
Shear	HBC-B 4.6	$V_{Rk,s}$	[kN]	13,9	20,2	- a)	- a)
	HBC-B A4-50			17,4	25,3	- a)	- a)
<b>Channel bolt type</b>				<b>HBC-C / HBC-C-E</b>			
Tension	HBC-C / HBC-C-E 4.6	$N_{Rk,s}$	[kN]	23,2	33,7	62,8	98,0
	HBC-C / HBC-C-E 8.8			46,4	67,4	125,6	174,3
	HBC-C / HBC-C-E A4-50			29,0	42,2	78,5	122,5
Shear	HBC-C / HBC-C-E 4.6	$V_{Rk,s}$	[kN]	13,9	20,2	37,7	58,8
	HBC-C / HBC-C-E 8.8			23,2	33,7	62,8	101,7
	HBC-C / HBC-C-E A4-50			17,4	25,3	47,1	73,5
<b>Channel bolt type</b>				<b>HBC-C-N</b>			
Tension	HBC-C-N 8.8	$N_{Rk,s}$	[kN]	- a)	67,4	125,6	174,3
Shear	HBC-C-N 8.8	$V_{Rk,s}$	[kN]	- a)	33,7	62,8	101,7
<b>Channel bolt type</b>				<b>HBC-T</b>			
Tension	HBC-T 8.8	$N_{Rk,s}$	[kN]	- a)	67,4	125,6	174,3
Shear	HBC-T 8.8	$V_{Rk,s}$	[kN]	- a)	33,7	62,8	101,7

a) Product is not available in standard Hilti portfolio. For additional information please contact Hilti Engineering team.

**Design resistance for bolts**

Channel bolt diameter				M10	M12	M16	M20
<b>Channel bolt type</b>				<b>HBC-B</b>			
Tension	HBC-B 4.6	$N_{Rd,s}$	[kN]	11,6	16,9	- a)	- a)
	HBC-B A4-50			10,1	14,8	- a)	- a)
Shear	HBC-B 4.6	$V_{Rd,s}$	[kN]	8,3	12,1	- a)	- a)
	HBC-B A4-50			7,3	10,6	- a)	- a)
<b>Channel bolt type</b>				<b>HBC-C / HBC-C-E</b>			
Tension	HBC-C / HBC-C-E 4.6	$N_{Rd,s}$	[kN]	11,6	16,9	31,4	49,0
	HBC-C / HBC-C-E 8.8			30,9	44,9	83,7	116,2
	HBC-C / HBC-C-E A4-50			10,1	14,8	27,4	42,8
Shear	HBC-C / HBC-C-E 4.6	$V_{Rd,s}$	[kN]	8,3	12,1	22,6	35,2
	HBC-C / HBC-C-E 8.8			18,6	27,0	50,2	67,8
	HBC-C / HBC-C-E A4-50			7,3	10,6	19,8	30,9
<b>Channel bolt type</b>				<b>HBC-C-N</b>			
Tension	HBC-C-N 8.8	$N_{Rd,s}$	[kN]	- a)	44,9	83,7	116,2
Shear	HBC-C-N 8.8	$V_{Rd,s}$	[kN]	- a)	27,0	50,2	67,8
<b>Channel bolt type</b>				<b>HBC-T</b>			
Tension	HBC-T 8.8	$N_{Rd,s}$	[kN]	- a)	44,9	83,7	116,2
Shear	HBC-T 8.8	$V_{Rd,s}$	[kN]	- a)	27,0	50,2	67,8

a) Product is not available in standard Hilti portfolio. For additional information please contact Hilti Engineering team.

**Note:** combined effects of loads (tension and shear) must be verified additionally. For detailed design of fixing point please use Hilti PROFIS Anchor Channel software, consult ETA-11/0006 or contact Hilti Engineering team.

## Seismic loading

### All data in this section applies to:

- Correct setting (See setting instruction)
- No edge distance and spacing influence
- No influence of bolt type and diameter
- Decisive failure mode – local flexure of channel lips
- Shear load applied perpendicular to the longitudinal axis of the channel

### Effective anchorage depth

Anchor channel type			HAC-V					HAC-V-T		
Anchor channel size			35	40	50	60	70	30	50	70
Minimum effective anchorage depth <sup>a)</sup>	$h_{ef,min}$	[mm]	91	91	71	148	175	68	71	175
Minimum thickness of concrete member <sup>a) b)</sup>	$h_{min}$	[mm]	105	105	90	168	196	80	90	196

a) HAC-V 50, 60, 70 and HAC-V-T 50, 70 are produced with different length of anchors and as well available with increased embedment depth, which will lead to increased concrete cone capacity. Additional information is presented in Setting details;

b) Minimum thickness of concrete member depends on the minimum edge distance. Additional information is presented in Setting details

### Characteristic resistance

Anchor channel type			HAC-V					HAC-V-T		
Anchor channel size			35	40	50	60	70	30	50	70
<b>Seismic performance category C1</b>										
Tension	$N_{Rk,s,l,eq}^0$	[kN]	31,4	31,4	40,0	40,0	71,0	19,9	41,0	71,0
Shear	$V_{Rk,s,l,eq}^0$	[kN]	37,4	37,4	55,0	55,0	102,9	27,7	60,5	118,8

### Design resistance

Anchor channel type			HAC-V					HAC-V-T		
Anchor channel size			35	40	50	60	70	30	50	70
<b>Seismic performance category C1</b>										
Tension	$N_{Rd,s,l,eq}^0$	[kN]	17,4	17,4	22,8	30,6	39,4	11,1	22,8	39,4
Shear	$V_{Rd,s,l,eq}^0$	[kN]	20,8	20,8	30,6	46,1	57,2	15,4	33,6	66,0

**Note:** Values shown in table above are representing only limited amount of the possible failure modes and might be used only for comparison of different products. For detailed design of fixing point please use Hilti PROFIS Anchor Channel software, consult ETA-11/0006 or contact Hilti Engineering team.

## Fire resistance

### All data in this section applies to:

- Correct setting (See setting instruction)
- No edge distance and spacing influence
- No influence of bolt type and diameter
- Decisive failure mode – steel failure  
(one of the following: anchor, connection between anchor and channel, local flexure of channel lip)
- Shear load applied perpendicular to the longitudinal axis of the channel
- Partial safety factor for resistance under fire exposure  $\gamma_{M,fi}=1,0$  (in absence of other national regulations)

### Effective anchorage depth

Anchor channel type			HAC-V					HAC-V-T		
Anchor channel size			35	40	50	60	70	30	50	70
Minimum effective anchorage depth <sup>a)</sup>	$h_{ef,min}$	[mm]	91	91	71	148	175	68	71	175
Minimum thickness of concrete member <sup>a) b)</sup>	$h_{min}$	[mm]	105	105	90	168	196	80	90	196

- a) HAC-V 50, 60, 70 and HAC-V-T 50, 70 are produced with different length of anchors and as well available with increased embedment depth, which will lead to increased concrete cone capacity. Additional information is presented in Setting details;
- b) Minimum thickness of concrete member depends on the minimum edge distance. Additional information is presented in Setting details

### Characteristic resistance

Anchor channel type			HAC-V					HAC-V-T (serrated)			
Anchor channel size			35	40	50	60	70	30	50	70	
<b>Fire exposure R60</b>											
Tension = Shear	Bolt M10	$N_{Rk,s,fi}$ = $V_{Rk,s,fi}$	[kN]	1,7	1,7	1,7	1,7	1,7	1,3	-	-
	Bolt M12			2,4	2,4	2,4	2,4	2,4	1,8	-	-
	Bolt M16			2,4	2,4	4,0	4,0	4,0	-	-	-
	Bolt M20			2,4	2,4	4,0	4,7	4,7	-	-	-
<b>Fire exposure R120</b>											
Tension = Shear	Bolt M10	$N_{Rk,s,fi}$ = $V_{Rk,s,fi}$	[kN]	1,0	1,0	1,0	1,0	1,0	0,7	-	-
	Bolt M12			1,5	1,5	1,5	1,5	1,5	0,8	-	-
	Bolt M16			1,5	1,5	1,6	1,6	1,6	-	-	-
	Bolt M20			1,5	1,5	1,6	2,1	2,1	-	-	-

### Characteristic resistance

Anchor channel type			HAC-V					HAC-V-T (serrated)			
Anchor channel size			35	40	50	60	70	30	50	70	
<b>Fire exposure R60</b>											
Tension = Shear	Bolt M10	$N_{Rd,s,fi}$ = $V_{Rd,s,fi}$	[kN]	1,7	1,7	1,7	1,7	1,7	1,3	-	-
	Bolt M12			2,4	2,4	2,4	2,4	2,4	1,8	-	-
	Bolt M16			2,4	2,4	4,0	4,0	4,0	-	-	-
	Bolt M20			2,4	2,4	4,0	4,7	4,7	-	-	-
<b>Fire exposure R120</b>											
Tension = Shear	Bolt M10	$N_{Rd,s,fi}$ = $V_{Rd,s,fi}$	[kN]	1,0	1,0	1,0	1,0	1,0	0,7	-	-
	Bolt M12			1,5	1,5	1,5	1,5	1,5	0,8	-	-
	Bolt M16			1,5	1,5	1,6	1,6	1,6	-	-	-
	Bolt M20			1,5	1,5	1,6	2,1	2,1	-	-	-

**Note:** Values shown in table above are representing only limited amount of the possible failure modes and might be used only for comparison of different products. For detailed design of fixing point please use Hilti PROFIS Anchor Channel software, consult ETA-11/0006 or contact Hilti Engineering team.

**Minimum axis distance of reinforcement**

Anchorage channel type		HAC-V					HAC-V-T (serrated)		
		35	40	50	60	70	30	50	70
<b>Fire exposure R60</b>									
Minimum axis distance	a [mm]	35	35	50	50	50	35	-	-
<b>Fire exposure R120</b>									
Minimum axis distance	a [mm]	60	60	60	65	70	60	-	-

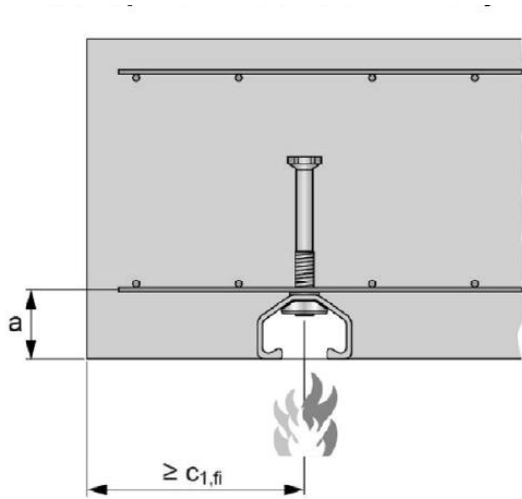
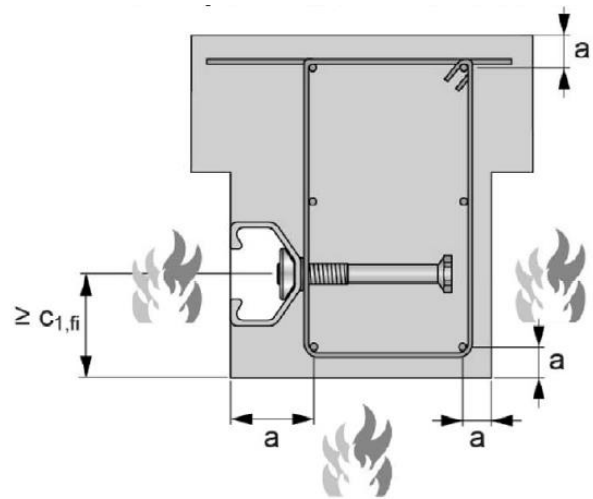
**Fire exposure from one side only**

**Fire exposure from more than one side**

## Fatigue resistance

### All data in this section applies to:

- Correct setting (See setting instruction)
- No edge distance and spacing influence
- No influence of bolt type and diameter
- Shear load applied perpendicular to the longitudinal axis of the channel

### Combination of anchor channels and channel bolts under fatigue tension load

Anchor channel	Channel bolt type	Diameter	Steel grade	Corrosion protection
HAC-V-T 30	HBC-B	M10	4.6	G <sup>a)</sup> F (HDG) <sup>b)</sup>
		M12		
HAC-V 35 HAC-V 40	HBC-C	M12	4.6	
		M16		
M20				
M16		8.8		
M20				
M16				
M20				
HAC-V 50			M16	
HAC-V 60			M20	
HAC-V 70			M20	

a) Electroplated

b) Hot-dip galvanized

### Characteristic resistance

Anchor channel type	HAC-V (plain)					HAC-V-T (serrated)		
	35	40	50	60	70	30		
<b>Fire exposure R60</b>								
Characteristic resistance under fatigue tension load after n load cycles without static preload	$\leq 10^6$	1,57	1,57	2,66	3,54	6,44	1,76	
	$\leq 3 \cdot 10^6$							
	$\leq 10^7$	1,5	1,5	2,6	3,5	6,4	1,6	
	$\leq 3 \cdot 10^7$							
	$\leq 6 \cdot 10^7$							
$> 6 \cdot 10^7$								
Reduction factor after n load cycles without static preload for: $\Delta N_{Rk,p,0,n} = \eta_{c,fat} \cdot N_{Rk,p}$ $\Delta N_{Rk,c,0,n} = \eta_{c,fat} \cdot N_{Rk,c}$	$\leq 10^6$	0,600						
	$\leq 3 \cdot 10^6$	0,571						
	$\leq 10^7$	0,542						
	$\leq 3 \cdot 10^7$	0,516						
	$\leq 6 \cdot 10^7$	0,500						
$> 6 \cdot 10^7$								
Characteristic fatigue limit resistance without static	$(n \rightarrow \infty)$	$\Delta N_{Rk,s,0,\infty}$ [kN]	1,5	1,5	2,6	3,5	6,4	1,6
Reduction factor for fatigue limit resistance without static preload ( $N_{Ed} = 0$ ) for: $\Delta N_{Rk,p,0,n} = \eta_{c,fat} \cdot N_{Rk,p}$ $\Delta N_{Rk,c,0,n} = \eta_{c,fat} \cdot N_{Rk,c}$	$(n \rightarrow \infty)$	$\eta_{c,fat}$ [-]	0,5					

**Note:** Values shown in table above are representing only limited amount of the possible failure modes and might be used only for comparison of different products. For detailed design of fixing point please use Hilti PROFIS Anchor Channel software, consult ETA-11/0006 or contact Hilti Engineering team.

## Materials

### Material quality for anchor channels

Part		Material
Channel profile	HAC-V F	Carbon steel according to EN 10025:2004 Hot-dip galvanized $\geq 50 \mu\text{m}$ <sup>a)</sup> or $\geq 70 \mu\text{m}$ <sup>b)</sup> according to EN ISO 1461:2009
Rivet	HAC-V F	Carbon steel Hot-dip galvanized $\geq 45 \mu\text{m}$ according to EN ISO 1461:2009
Anchor	HAC-V F	Carbon steel Hot-dip galvanized $\geq 45 \mu\text{m}$ according to EN ISO 1461:2009

a) For HAC-V-T 30F, HAC-V 35F, HAC-V 40 F, HAC-V-50 F, HAC-V-T 50 F;

b) For HAC-V 60 F, HAC-V-70 F, HAC-V-T-70 F

### Material quality for channel bolts

Part		Material
Channel bolts	HBC	Carbon steel grade 4.6 and 8.8 according to EN ISO 898-1:2013 Electroplated $\geq 8 \mu\text{m}$ according to DIN EN ISO 4042: 1999
	HBC F	Carbon steel grade 4.6 and 8.8 according to EN ISO 898-1:2013 Hot-dip galvanized $\geq 45 \mu\text{m}$ according to EN ISO 1461: 2009
	HBC A4	Stainless steel grade 50 according to EN ISO 3506-1: 1.4401 / 1.4404 / 1.4571 / 1.4362 / 1.4578 / 1.4439
Plain washer	Galvanized	Carbon steel Hardness class A $\geq 200 \text{ HV}$ Electroplated $\geq 8 \mu\text{m}$ according to DIN EN ISO 4042: 1999
	F	Carbon steel Hardness class A $\geq 200 \text{ HV}$ Hot-dip galvanized $\geq 45 \mu\text{m}$ according to EN ISO 1461: 2009
	A4	Stainless steel Hardness class A $\geq 200 \text{ HV}$ 1.4401 / 1.4404 / 1.4571 / 1.4362 / 1.4578 / 1.4439
Hexagonal nut <sup>a)</sup>	Galvanized	Carbon steel Property class 8 according to EN ISO 898-2: 2012 Electroplated $\geq 8 \mu\text{m}$
	F	Carbon steel Property class 8 according to EN ISO 898-2: 2012 Hot-dip galvanized $\geq 45 \mu\text{m}$ according to EN ISO 1461: 2009
	A4	Stainless steel Property class 70 according to EN ISO 3506-2: 2009 1.4401 / 1.4404 / 1.4571 / 1.4362 / 1.4578 / 1.4439

a) Hexagonal nuts according to DIN 934: 1987-10 for channel bolts made from carbon steel (4.6) and stainless steel

### Mechanical properties

Part			HAC-V / HBC
Nominal tensile strength	Carbon steel 4.6	$f_{uk}$ [N/mm <sup>2</sup> ]	400
	Carbon steel 8.8		800 / 830 <sup>a)</sup>
	Stainless steel A4-50		500
Yield strength	Carbon steel 4.6	$f_{yk}$ [N/mm <sup>2</sup> ]	240
	Carbon steel 8.8		640 / 660 <sup>a)</sup>
	Stainless steel A4-50		210

a) Material properties according to EN ISO 898-1

**Corrosion class**

Class / Mark	Material / Coating type
G	Carbon steel, electroplated
F (HDG)	Carbon steel, hot-dip galvanized
R (A4)	Stainless steel

**Nomenclature of HAC-V anchor channels (example)**

Hilti anchor channel type	Profile type and size	Effective embedment depth	Channel length	Finish or material
①	②	③	④	⑤
HAC-V	T 50	106	350	F (HDG)
HAC-V	50	106	300	F (HDG)

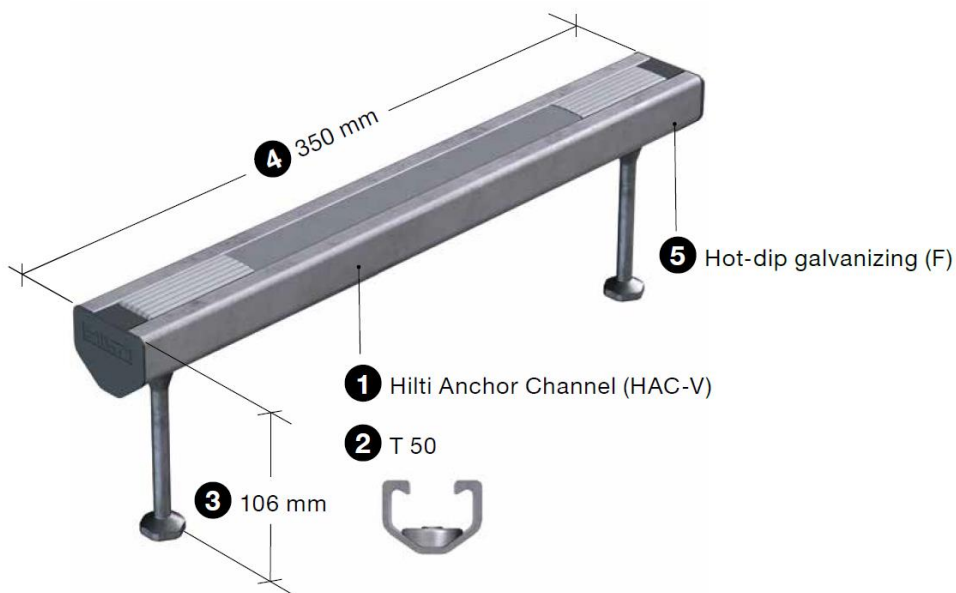
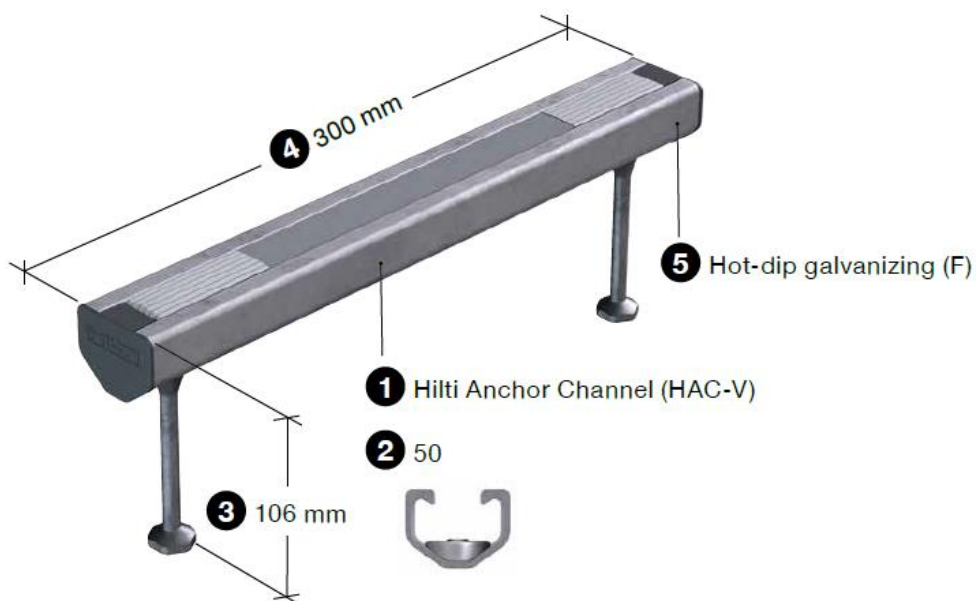
**HAC-V-T 50 106/350 F**

**HAC-V 50 106/300 F**

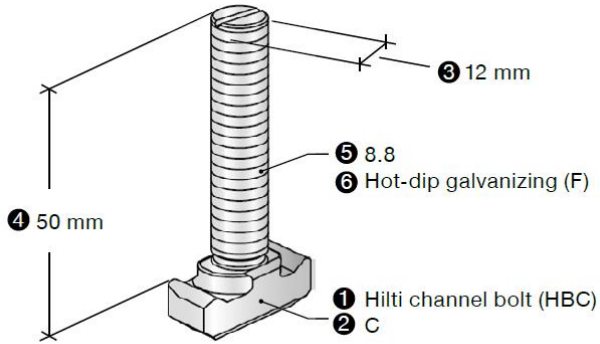
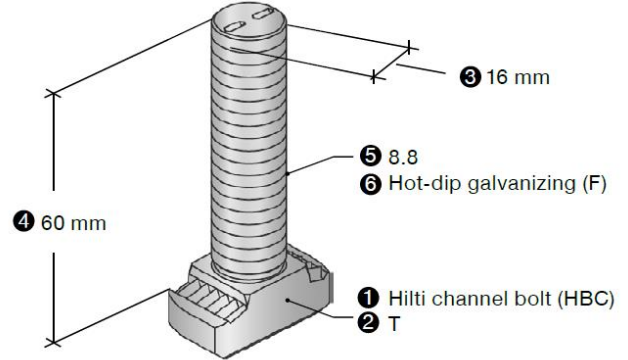

**Nomenclature of HBC channel bolts (example)**

Hilti channel bolt ①	Bolt type ②	Diameter ③	Bolt length ④	Steel grade ⑤	Finish or material ⑥
HBC	C	M12	50	8.8	F (HDG)
HBC	T	M16	60	8.8	F (HDG)

**HBC-C M12x50 8.8 F**

**HBC-T M16x60 8.8 F**

## Dimensions of anchor channels

### Dimensions of channel profile

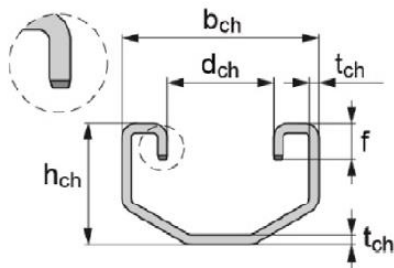
Anchor channel type			HAC-V					HAC-V-T (serrated)		
Anchor channel size			35	40	50	60	70	30	50	70
Channel width	$b_{ch}$	[mm]	40,9	40,9	41,9	43,4	45,4	41,3	41,9	45,4
Channel height	$h_{ch}$	[mm]	28,0	28,0	31,0	35,5	40,0	25,6	31,0	40,0
Nominal thickness	$t_{ch}$	[mm]	2,25	2,25	2,75	3,50	4,50	2,00	2,75	4,50
Width of channel opening	$d_{ch}$	[mm]	19,5	19,5	19,5	19,5	19,5	22,3	19,5	19,5
Height of channel lips	$f$	[mm]	4,5	4,5	5,3	6,3	7,4	7,5	5,3	7,1
Moment of inertia	$I_y$	[mm <sup>4</sup> ]	21463	21463	33125	57930	95457	15349	33125	92192

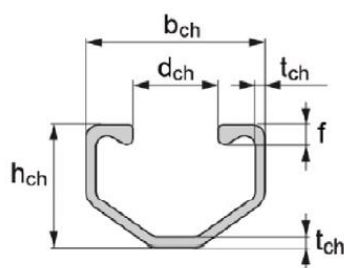
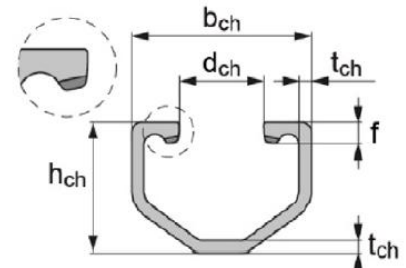

HAC-V-T 30

 HAC-V 35, HAC-V 40, HAC-V 50,  
HAC-V 60, HAC-V 70

HAC-V-T 50, HAC-V-T 70

### Dimensions of anchors

Anchor channel type			HAC-V					HAC-V-T (serrated)		
Anchor channel size			35	40	50	60	70	30	50	70
Minimum anchor length	min. $l_a$	[mm]	66,0	66,0	78,5	117,0	140,0	44,4	78,5	14,0
Diameter of anchor	$d_a$	[mm]	7,2	7,2	9,0	9,0	10,9	5,4	9,0	10,9
Diameter of round anchor head	$d_h$	[mm]	17,5	17,5	19,5	19,5	23,0	11,5	19,5	23,0
Thickness of round anchor head	$t_h$	[mm]	3,0	3,0	3,5	4,5	5,0	2,0	3,5	5,0
Area of round anchor head	$A_h$	[mm <sup>2</sup> ]	209,0	209,0	258,0	258,0	356,0	89,0	258,0	356,0

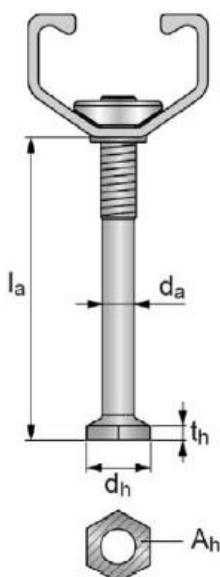

HAC with bolted anchor

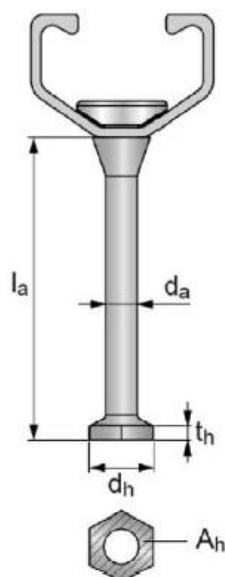

HAC-V with bolted anchor

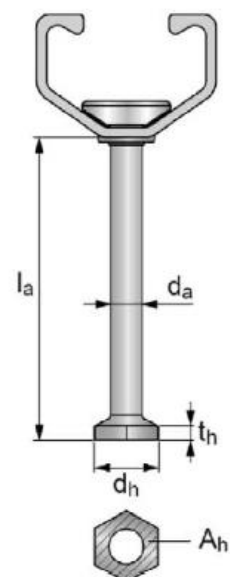

Welded anchor

## Dimensions of channel bolts

### Dimensions of channel bolts

Channel bolt type			HBC-B	
Appropriate anchor channel			HAC-V-T 30	
Nominal diameter	d	[mm]	10,0	12,0
Width (1)	b <sub>1</sub>	[mm]	19,0	
Width (2)	b <sub>2</sub>	[mm]	34,0	
Thickness	k	[mm]	9,2	

### Dimensions of channel bolts

Channel bolt type			HBC-C-E	
Appropriate anchor channel			HAC-V 35 ; HAC-V 40 ; HAC-V 50	
Nominal diameter	d	[mm]	12,0	16,0
Width (1)	b <sub>1</sub>	[mm]	14,0	17,0
Width (2)	b <sub>2</sub>	[mm]	33,0	
Thickness	k	[mm]	10,4	13,4

### Dimensions of channel bolts

Channel bolt type			HBC-C			
Appropriate anchor channel			HAC-V 35 ; HAC-V 40 ; HAC-V 50 ; HAC-V 60 ; HAC-V 70			
Nominal diameter	d	[mm]	10,0	12,0	16,0	20,0
Width (1)	b <sub>1</sub>	[mm]	14,0		18,5	
Width (2)	b <sub>2</sub>	[mm]	33,0			
Thickness	k	[mm]	10,4		11,4	13,9

Single groove  
for marking the  
position

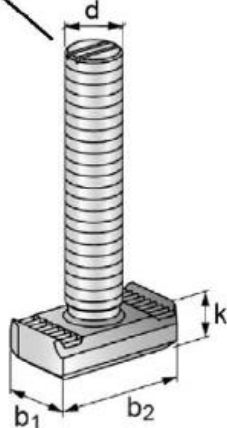

HBC-B

Single groove  
for marking the  
position

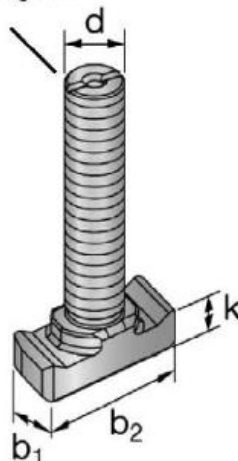

HBC-C-E

Single groove  
for marking the  
position

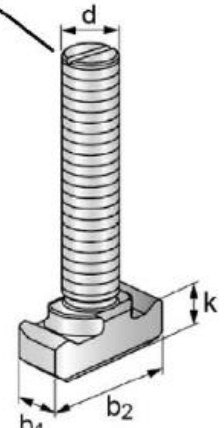

HBC-C

**Dimensions of channel bolts**

Channel bolt type			HBC-C-N		
Appropriate anchor channel			HAC-V 35 ; HAC-V 40 ; HAC-V 50 ; HAC-V 60 ; HAC-V 70		
Nominal diameter	d	[mm]	12,0	16,0	20,0
Width (1)	b <sub>1</sub>	[mm]	18,5		
Width (2)	b <sub>2</sub>	[mm]	33,0		
Thickness	k	[mm]	11,4		13,9

**Dimensions of channel bolts**

Channel bolt type			HBC-T		
Appropriate anchor channel			HAC-T 50 ; HAC-T 70 ; HAC-V-T 50 ; HAC-V-T 70		
Nominal diameter	d	[mm]	12,0	16,0	20,0
Width (1)	b <sub>1</sub>	[mm]	18,5		
Width (2)	b <sub>2</sub>	[mm]	35,4		
Thickness	k	[mm]	12,0		

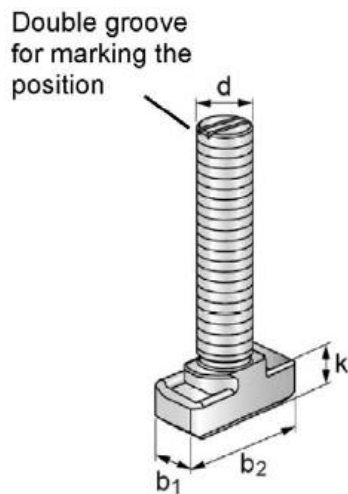
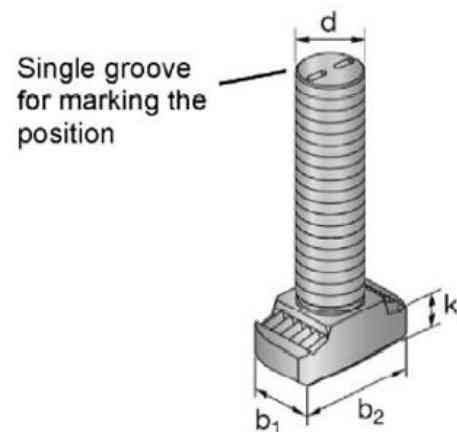

**HBC-C-N**

**HBC-T**

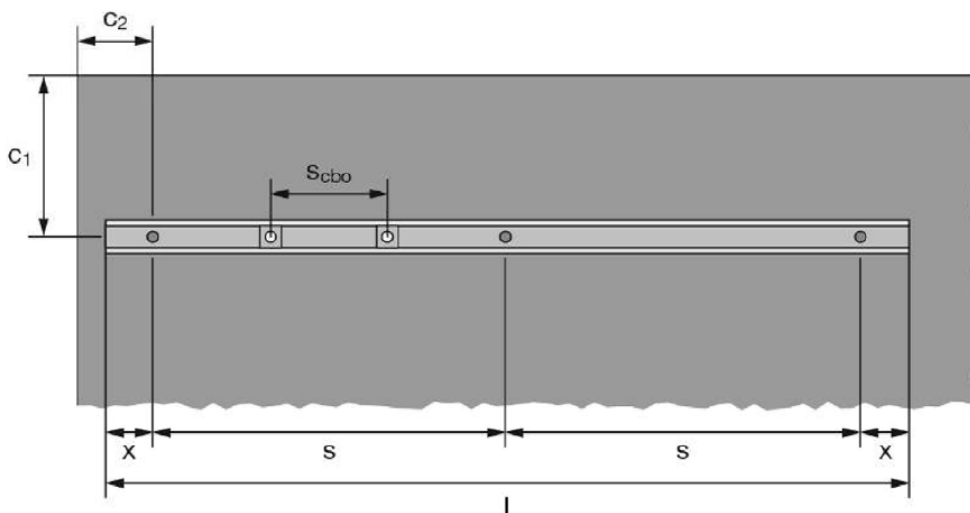
**Setting information**
**Setting details for anchor channels**

Anchor channel type	HAC-V										HAC-V-T (serrated)							
	35		40		50		60		70		30		50		70			
Minimum effective embedment depth	$h_{ef,min}$	[mm]	91	91	110	71	106	148	183	175	295	68	71	106	175	295		
Minimum spacing	$s_{min}$	[mm]	100	100	100	150	100	100	100	100	50	100	150	100	100			
Maximum spacing	$s_{max}$	[mm]	250	250	250		250		250		250	250		250				
End spacing	$x$	[mm]	25	25	25		25		25		25	25		25				
Minimum channel length	$l_{min}$	[mm]	150	150	150	200	150	150	150	150	100	150	200	150	150			
Minimum edge distance	$c_{min}$	[mm]	50	50	50	100	50	75	63,5	75	63,5	50	50	100	50	75	63,5	
Minimum thickness of concrete member	$h_{min}$	[mm]	105	105	125	125	90	125	168	400	196	400	80	125	90	125	196	400
			$h_{ef} + t_h + c_{nom}^a)$															

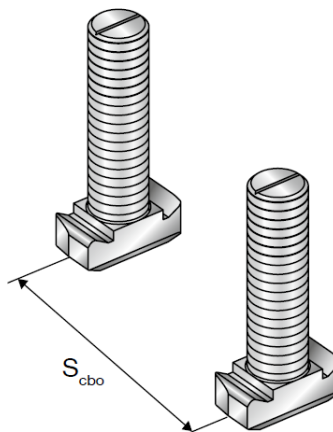
 a)  $c_{min}$  according to EN 1992-1-1:2004 + AC2010

**Setting details for channel bolts**

Anchor channel size	M10	M12	M16	M20		
Minimum spacing between channel bolts	$s_{cbo,min}$	[mm]	50	60	80	100

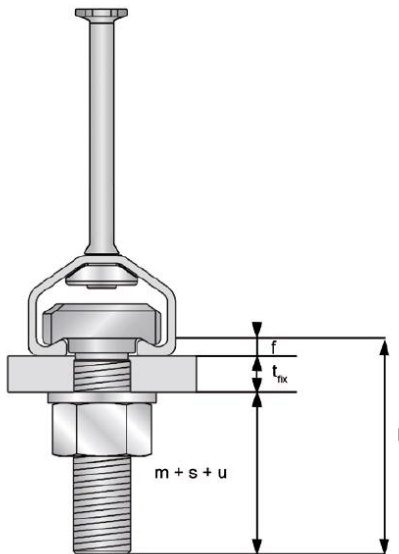

**Determination of the minimum required T-bolt length**

Anchor channel type			HAC-V					HAC-V-T (serrated)			
Anchor channel size			35	40	50	60	70	30	50	70	
Channel bolt type			HBC-C(-E)			HBC-C		HBC-B	HBC-T		
Height of channel lip	f	[mm]	4,5	4,5	5,3	6,3	7,4	7,5	5,2	7,1	
Thickness of nut, washer and channel bolt projection	Bolt M10	m	[mm]	13,9	13,9	13,9	13,9	13,9	13,9	-	-
	Bolt M12	+		17,3	17,3	17,3	17,3	17,3	17,3	17,3	17,3
	Bolt M16	+		21,8	21,8	21,8	21,8	21,8	-	21,8	21,8
	Bolt M20	u		-	-	27,0	27,0	27,0	-	27,0	27,0

**Dimensions**

l	[mm]	nominal length of channel bolt
t <sub>fix</sub>	[mm]	fastenable thickness (thickness of the attached part)
f	[mm]	height of channel lip
m	[mm]	thickness of the nut (ISO 4032)
s	[mm]	thickness of the washer
u	[mm]	channel bolt projection

Required T-Bolt length :  $l = t_{fix} + f + (m + s + u)$

## Setting instructions

\*For detailed information on installation see instruction for use given with the package of the product

## Setting instruction for anchor channel

## 1. Correct selection of anchor channel

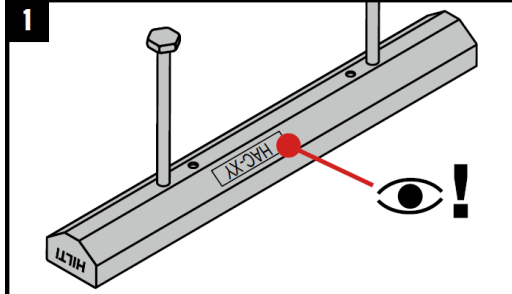

## 2. Cut the anchor channel (if necessary) with required end spacing

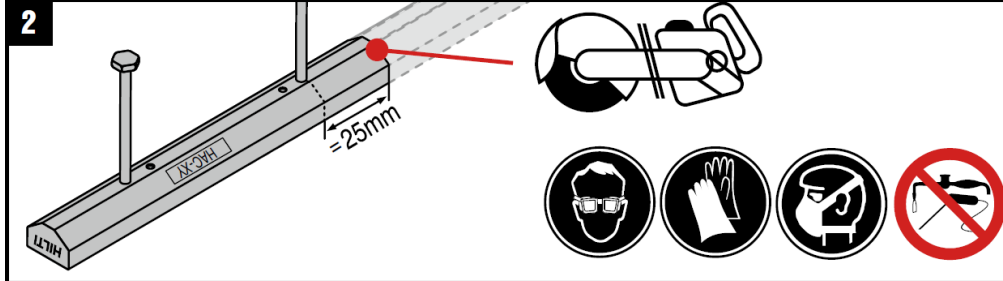

## 3. Position of anchor channel flush with the surface

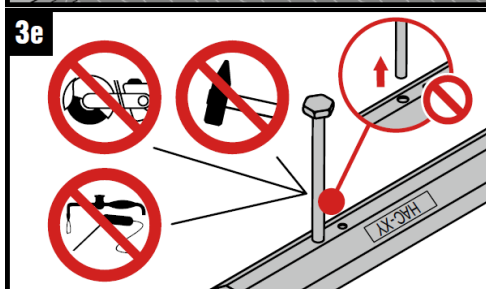
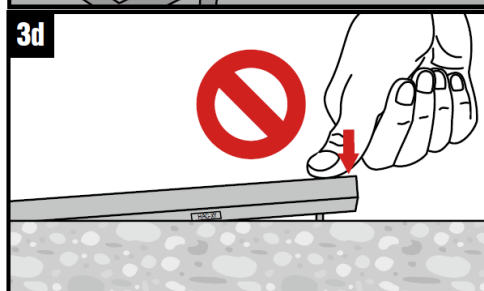
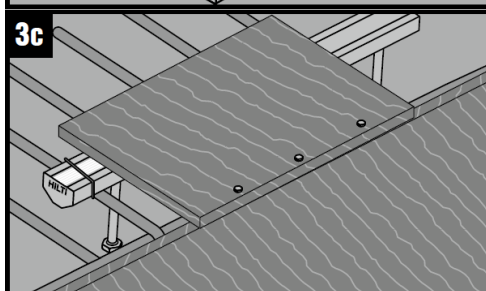
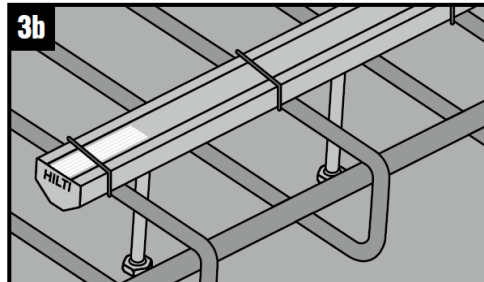
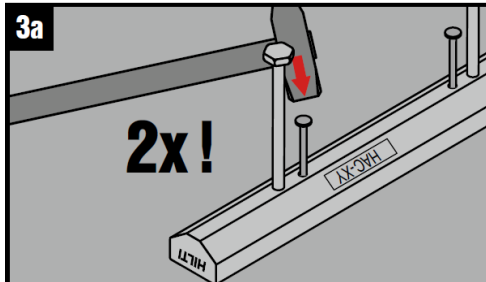

**4. Pouring the concrete**

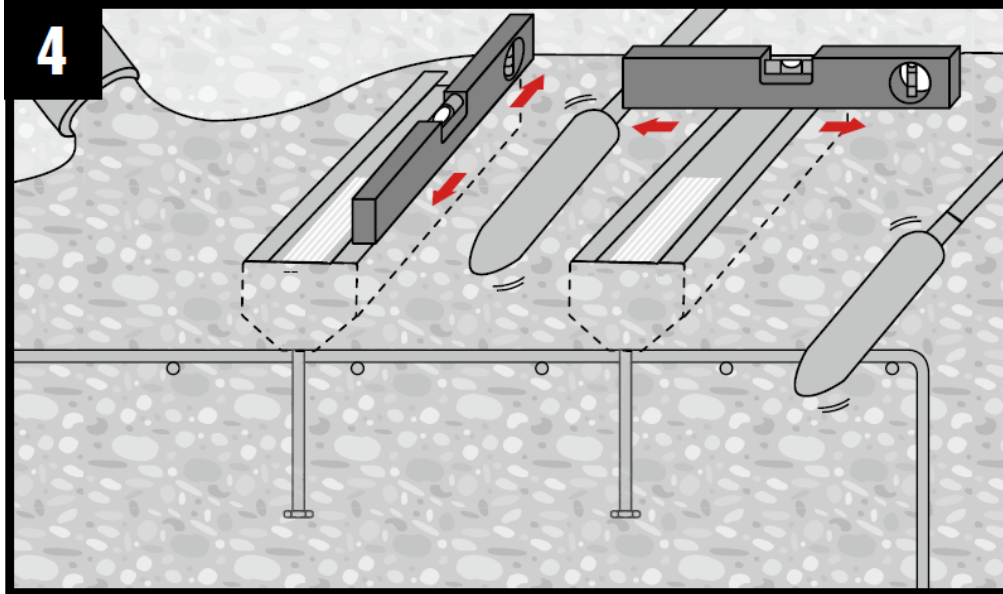

**5. Remove the wormwork**

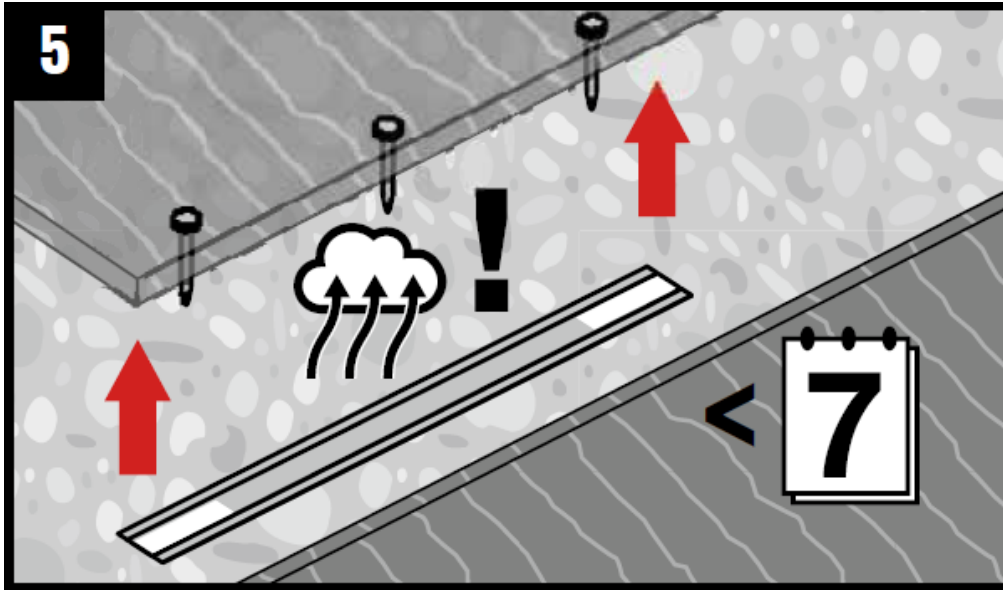

**6. Check the position of anchor channel**

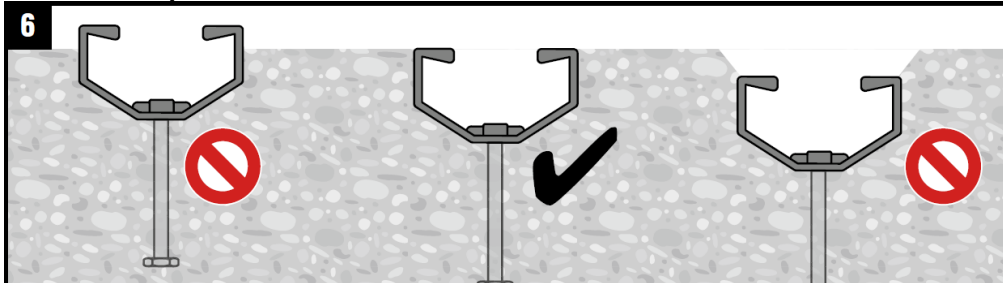

**7. Remove the foam filler after hardening of concrete**

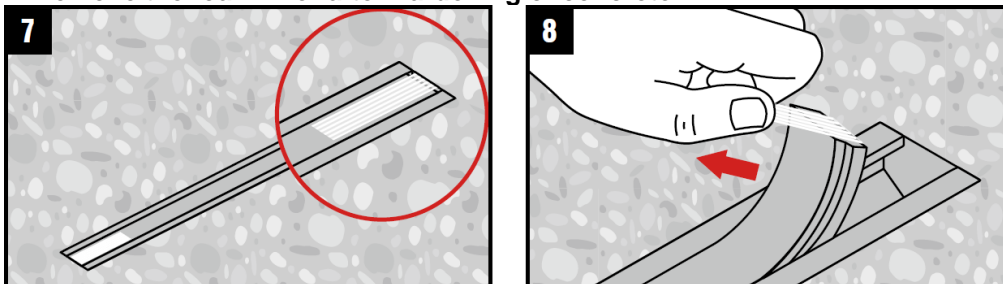



\*For detailed information on installation see instruction for use given with the package of the product

### Setting instruction for channel bolts

#### 1. Correct selection of channel bolt

HBC-C 4.6 HBC-C 8.8 HBC-C A4-50 HBC-C-E 8.8	HAC(-V)-35 to HAC(-V)-70 HAC(-V)-50 to HAC(-V)-70 XT/XTS HAC(-V)-40 to HAC(-V)-70 CRFoS HAC(-V)-40, -50 EDGE (Lite)

#### 2-5. Installation of the channel bolt

#### 6. Installation of the fixture

#### 7. Apply the installation torque $T_{inst}$ <sup>a)</sup>

M10 M12 M16 M20	AT-System SI-AT-A22 + SIW 6AT-A22**
--------------------------	---

a) Required  $T_{inst}$  value and compatibility with SI-AT tool must be checked additionally

## **ACKNOWLEDGMENT**

To Aleksander Gubskiy and Riccardo Figoli: without them, the release of this FTM would have not been possible.



Hilti Aktiengesellschaft  
9494 Schaan, Liechtenstein  
P +423-234 2965

[www.facebook.com/hiltigroup](https://www.facebook.com/hiltigroup)  
[www.hilti.group](https://www.hilti.group)